

**Oracle Utilities Analytics for Oracle
Utilities Extractors and Schema and
Oracle Utilities Analytics Dashboards**

Administration Guide

Release 2.5.0.0.1

E48998-02

February 2014

Oracle Utilities Analytics for Oracle Utilities Extractors and Schema and Oracle Utilities Analytics Dashboards,
Release 2.5.0.0.1

E48998-02

Copyright © 2014, Oracle and/or its affiliates. All rights reserved.

This software and related documentation are provided under a license agreement containing restrictions on use and disclosure and are protected by intellectual property laws. Except as expressly permitted in your license agreement or allowed by law, you may not use, copy, reproduce, translate, broadcast, modify, license, transmit, distribute, exhibit, perform, publish, or display any part, in any form, or by any means. Reverse engineering, disassembly, or decompilation of this software, unless required by law for interoperability, is prohibited.

The information contained herein is subject to change without notice and is not warranted to be error-free. If you find any errors, please report them to us in writing.

If this is software or related documentation that is delivered to the U.S. Government or anyone licensing it on behalf of the U.S. Government, the following notice is applicable:

U.S. GOVERNMENT END USERS: Oracle programs, including any operating system, integrated software, any programs installed on the hardware, and/or documentation, delivered to U.S. Government end users are “commercial computer software” pursuant to the applicable Federal Acquisition Regulation and agency-specific supplemental regulations. As such, use, duplication, disclosure, modification, and adaptation of the programs, including any operating system, integrated software, any programs installed on the hardware, and/or documentation, shall be subject to license terms and license restrictions applicable to the programs. No other rights are granted to the U.S. Government.

This software or hardware is developed for general use in a variety of information management applications. It is not developed or intended for use in any inherently dangerous applications, including applications that may create a risk of personal injury. If you use this software or hardware in dangerous applications, then you shall be responsible to take all appropriate fail-safe, backup, redundancy, and other measures to ensure its safe use. Oracle Corporation and its affiliates disclaim any liability for any damages caused by use of this software or hardware in dangerous applications.

Oracle and Java are registered trademarks of Oracle and/or its affiliates. Other names may be trademarks of their respective owners.

Intel and Intel Xeon are trademarks or registered trademarks of Intel Corporation. All SPARC trademarks are used under license and are trademarks or registered trademarks of SPARC International, Inc. AMD, Opteron, the AMD logo, and the AMD Opteron logo are trademarks or registered trademarks of Advanced Micro Devices. UNIX is a registered trademark of The Open Group.

This software or hardware and documentation may provide access to or information on content, products, and services from third parties. Oracle Corporation and its affiliates are not responsible for and expressly disclaim all warranties of any kind with respect to third-party content, products, and services. Oracle Corporation and its affiliates will not be responsible for any loss, costs, or damages incurred due to your access to or use of third-party content, products, or services.

Contents

Preface	i-i
Audience	i-i
Prerequisite Knowledge.....	i-i
How This Guide is Organized?	i-ii
Related Documents	i-ii
Conventions.....	i-iii
Acronyms	i-iii
Chapter 1	
What's New in Oracle Utilities Analytics Version 2.5.0.0.1?	1-1
Chapter 2	
Overview of Data Warehouse	2-2
Source Application	2-2
ETL/ELT.....	2-2
Staging Area.....	2-2
Data Presentation Area.....	2-3
Chapter 3	
Overview of Oracle Utilities Analytics	3-4
What is Oracle Utilities Analytics?.....	3-4
Overview of Analytics.....	3-5
Data Processing	3-6
Oracle Warehouse Builder Based Extract, Transform and Load (ETL)	3-7
Extraction	3-7
Transfer.....	3-8
Load.....	3-8
Aggregation	3-8
Oracle Data Integrator Based Extract, Load and Transform (ELT).....	3-8
Replication.....	3-9
Staging.....	3-10
Target	3-10
Data Cleansing.....	3-10
Data Lineage	3-10
Aggregation	3-10
Chapter 4	
Configuring Oracle Utilities Analytics	4-12
Configuring the Source System	4-12
Oracle Data Integrator Based Extraction.....	4-12
Oracle Warehouse Builder Based Extraction.....	4-12
Configuring ETL/ELT.....	4-13
Oracle Warehouse Builder Based ETL.....	4-13
Oracle Data Integrator Based ELT	4-27
Configuring Analytics.....	4-34

Administration Dashboards.....	4-34
Configuring Dashboards.....	4-35
Performance Recommendations.....	4-43
Optimizing the Top N Answers.....	4-44

Chapter 5

Extending Oracle Utilities Analytics.....	5-45
Sample Use Case.....	5-45
User Defined Columns.....	5-47
User Defined Field.....	5-47
User Defined Measure.....	5-47
User Defined Degenerate Dimension.....	5-48
User Defined Foreign Key Dimensions.....	5-48
User Defined Dimension.....	5-48
Extending Star Schemas.....	5-49
Oracle Warehouse Builder Based Extension.....	5-49
Oracle Data Integrator Based Extension.....	5-53
Customizing Analytics.....	5-55
Modifying the RPD file.....	5-55
Customizing Answers.....	5-55
Customizing Report Labels.....	5-56

Chapter 6

Adding New Components.....	6-57
Creating a New Star Schema.....	6-57
Defining ETL for New Star Schema.....	6-58
Creating a New Oracle Warehouse Builder Workflow.....	6-60
Auto Cache Refresh.....	6-60
Creating a New Object for Oracle Data Integrator Based ELT.....	6-61
Configuring Entities.....	6-61
Setting Up Replication.....	6-62
Creating a New Model for the Facts.....	6-62
Creating a New Model for the Dimensions.....	6-62
Creating a New Model for the Replicated Objects.....	6-62
Creating a New Interface.....	6-63
Creating a New Package.....	6-63
Creating a New Interface for the Materialized View.....	6-64
Creating a New Analytics.....	6-64
Creating New Answers.....	6-64
Adding New Labels.....	6-65

Chapter 7

Maintaining Environments.....	7-66
Overview of Environment Maintenance.....	7-66
Moving Oracle Warehouse Builder Based Code.....	7-66
Database Cloning for Oracle Warehouse Builder.....	7-68
Oracle Data Integrator Based Products.....	7-70
Moving Oracle Data Integrator Repository.....	7-70
Moving Metadata.....	7-70
Purging.....	7-71

Chapter 8

Licensing and Optional Features.....	8-75
Oracle Database Licensing and Optional Features.....	8-75
Oracle Warehouse Builder Licensing and Optional Features.....	8-75
Disabling the Optional Features in Oracle Warehouse Builder.....	8-76
Oracle GoldenGate Licensing.....	8-77

Appendix A

Oracle Utilities Application Framework Extractors	A-1
Change Detect Mechanism	A-1
Fields on the Change Log.....	A-1
Structure of Triggers	A-2
Rows in the Change Log	A-2
Extracting and Transforming Data.....	A-2
Modes of Execution	A-2
Basic Parameters Supplied To Extract Processes	A-3

Appendix B

Oracle Utilities Analytics Administration	B-1
Metadata Tables	B-1
Product Instance	B-4
Target Entity.....	B-6
Job Configuration	B-8
Enable Jobs Page.....	B-8
Source Table	B-8
Job Executions	B-9
Oracle GoldenGate Configuration	B-11
Global Configuration	B-12

Appendix C

Oracle Utilities Customer Care and Billing Extractor Details	C-1
Performing Initial Load	C-1
ELT for Oracle Utilities Customer Care and Billing Analytics	C-3
Oracle Utilities Customer Care and Billing Older Extractors	C-3

Appendix D

Oracle Utilities Work and Asset Management Extractor Details	D-1
---	------------

Appendix E

Oracle Utilities Meter Data Management Extractor Details	E-1
Synchronization BO-Based Extract Details	E-2
Idiosyncratic Batch Extract Details	E-4

Appendix F

Oracle Utilities Mobile Workforce Management Extractor Details	F-1
---	------------

Appendix G

Oracle Utilities Network Management System Extractor Details	G-1
---	------------

Appendix H

Oracle Utilities Validation Functions and Error Identification Procedure Names	H-1
---	------------

Appendix I

Oracle Warehouse Builder ETL Components	I-1
External Table.....	I-1
Mapping	I-2
Workflow	I-2
Packages	I-2
File Manager	I-3

Appendix J

Oracle Warehouse Builder Deployment	J-1
Oracle Warehouse Builder Code Generator.....	J-1
Deploying TCL Files.....	J-3
Scheduling New Workflows.....	J-4

Appendix K

Oracle Data Integrator ELT Components	K-1
Packages	K-1

Appendix L

Terminology.....	L-1
Data Source Indicator	L-1
Late Arriving Dimension.....	L-1
Referencing Foreign Keys.....	L-2
Oracle Data Integrator.....	L-2
Context.....	L-2
Logical Schema	L-2
Physical Schema	L-3
Model.....	L-3
Interface	L-3
Package	L-3
Agent	L-3
Reverse Engineer	L-3
Journalization	L-3
Change Data Capture.....	L-4
Scenario	L-4
Knowledge Module	L-4

Preface

This guide provides instructions for configuring and administering Oracle Utilities Analytics (OUA), including:

- **Audience**
- **Prerequisite Knowledge**
- **How This Guide is Organized?**
- **Related Documents**
- **Conventions**
- **Acronyms**

Audience

This administration guide is intended for anyone interested in the process of configuring and administering Oracle Utilities Analytics.

Prerequisite Knowledge

Oracle Utilities Extractors and Schema and Oracle Utilities Analytics Dashboards use several technologies. You should have knowledge of the following before configuring and administering Oracle Utilities Analytics:

- Oracle Data Warehouse concepts:
http://docs.oracle.com/cd/E11882_01/server.112/e25554/toc.htm
- Oracle Warehouse Builder:
http://docs.oracle.com/cd/E11882_01/owb.112/e10581/toc.htm
- Oracle Data Integrator:
http://docs.oracle.com/cd/E21764_01/integrate.1111/e12641/overview.htm
- Oracle GoldenGate:
http://docs.oracle.com/cd/E35209_01/doc.1121/e29397.pdf
- Oracle WebLogic Server:
http://docs.oracle.com/cd/E15051_01/wls/docs103/pdf.html
- Oracle Business Intelligence Enterprise Edition:
http://docs.oracle.com/cd/E28280_01/bi.1111/e10544/toc.htm

How This Guide is Organized?

This guide helps you configure and administer Oracle Utilities Extractors and Schema Version 2.5.0.0.1 and Oracle Utilities Analytics Dashboards Version 2.5.0.0.1. This guide would refer to these two products together as Oracle Utilities Analytics. If any topic is specific to only one of the products, then it will be specifically mentioned.

Chapter 1 describes the new features and functionalities and new changes added in Oracle Utilities Analytics v2.5.0.0.1.

Chapter 2 gives a brief overview of the various components in a data warehouse.

Chapter 3 gives an overview of the Oracle Utilities Analytics product and its components such as, data warehouse, Extract, Transform and Load (ETL) and analytics. Make sure that you are familiar with these concepts before you proceed to configure the product.

Chapter 4 explains how to configure Oracle Utilities Analytics once it is installed. This configuration is mandatory for proper and expected functioning of Oracle Utilities Analytics. This is a must read before you start the implementation.

Chapter 5 explains how to extend Oracle Utilities Analytics. Oracle Utilities Analytics provides the out of the box star schemas, extract- transform - load programs, and analytics. This chapter explains how you can extend Oracle Utilities Extractors and Schema by utilizing user-defined fields. This is the only supported means of extending Oracle Utilities Extractors and Schema.

Chapter 6 explains that how to add new requirements. This chapter explains how to add a new star schema to Oracle Utilities Analytics. However, any new requirements are maintained by the customer. Oracle does not support changes to the base products (other than the ones explained in chapter 6), additional star schema or related functionality.

Chapter 7 describes methods to maintain the environment. The methods explained in this chapter help users in maintaining their environments easily. It is recommended that you refer to the related product documentation first and then read this chapter for the complete understanding.

Chapter 8 describes various licensing restrictions while using some of the Oracle products, that is, Oracle database, Oracle Warehouse Builder, Oracle Data Integrator, and Oracle GoldenGate. The out of the box functionalities are covered under the license agreement described as part of this product licensing. However, if you want to create any additional functionality using these products, please make sure it is covered under the licensing agreement, or you already have the additional licenses.

Related Documents

Refer to the following documents for the complete information:

- *Oracle Utilities Analytics for Oracle Utilities Extractors and Schema and Oracle Utilities Analytics Dashboards User's Guide*
- *Oracle Utilities Analytics for Oracle Utilities Extractors and Schema and Oracle Utilities Analytics Dashboards Administration Guide*
- *Oracle Utilities Analytics for Oracle Utilities Extractors and Schema and Oracle Utilities Analytics Dashboards Installation Guide*
- *Oracle Utilities Analytics for Oracle Utilities Extractors and Schema and Oracle Utilities Analytics Dashboards Quick Install Guide*
- *Oracle Utilities Analytics for Oracle Utilities Extractors and Schema and Oracle Utilities Analytics Dashboards Release Notes*
- *Oracle Utilities Analytics Dashboards for Oracle Utilities Meter Data Analytics Metric Reference Guide*

- *Oracle Utilities Analytics Dashboards for Oracle Utilities Customer Analytics, Revenue Analytics and Credit & Collections Analytics Metric Reference Guide*
- *Oracle Utilities Analytics Dashboards for Oracle Utilities Exception Analytics Metric Reference Guide*
- *Oracle Utilities Analytics Dashboards for Oracle Utilities Mobile Workforce Analytics Metric Reference Guide*
- *Oracle Utilities Analytics Dashboards for Oracle Utilities Distribution Analytics and Outage Analytics Metric Reference Guide*
- *Oracle Utilities Analytics Dashboards for Oracle Utilities Work and Asset Analytics Metric Reference Guide*
- *Oracle Utilities Analytics Dashboards for Oracle Utilities Operational Device Analytics Metric Reference Guide*
- *Oracle Utilities Extractors and Schema for Oracle Utilities Customer Care and Billing Data Mapping Guide*
- *Oracle Utilities Extractors and Schema for Oracle Utilities Meter Data Management Data Mapping Guide*
- *Oracle Utilities Extractors and Schema for Oracle Utilities Mobile Workforce Management Data Mapping Guide*
- *Oracle Utilities Extractors and Schema for Oracle Utilities Network Management System Data Mapping Guide*
- *Oracle Utilities Extractors and Schema for Oracle Utilities Operational Device Management Data Mapping Guide*
- *Oracle Utilities Extractors and Schema for Oracle Utilities Work & Asset Management Data Mapping Guide*

Conventions

The following text conventions are used in this document:

Convention	Meaning
boldface	Boldface type indicates graphical user interface elements associated with an action, or terms defined in text or the glossary.
<i>italic</i>	Italic type indicates book titles, emphasis, or placeholder variables for which you supply particular values.
monospace	Monospace type indicates commands within a paragraph, URLs, code in examples, text that appears on the screen, or text that you enter.

Acronyms

The list of acronyms used in this guide is as explained below:

- **APEX**: Oracle Application Express
- **CC&B**: Oracle Utilities Customer Care and Billing
- **CDC**: Changed Data Capture
- **ELT**: Extraction, Loading and Transformation

-
- **ETL:** Extraction, Transformation and Loading
 - **MDM:** Oracle Utilities Meter Data Management
 - **MWM:** Oracle Utilities Mobile Workforce Management
 - **NMS:** Oracle Utilities Network Management System
 - **OBIEE:** Oracle Business Intelligence Enterprise Edition
 - **ODI:** Oracle Data Integrator
 - **ODM:** Oracle Utilities Operational Device Management
 - **OGG:** Oracle GoldenGate
 - **OUA:** Oracle Utilities Analytics
 - **OWB:** Oracle Warehouse Builder
 - **WAM:** Oracle Utilities Work and Asset Management

Chapter 1

What's New in Oracle Utilities Analytics Version 2.5.0.0.1?

Oracle Utilities Analytics is a set of star schemas, graphic templates, and data processing programs that allows you to build a Business Intelligence (BI) solution to meet your organization's analytic requirements.

With this new release of Oracle Utilities Analytics v2.5.0.0.1, the product has started the process of migrating from Oracle Warehouse Builder (OWB) based ETL to Oracle Data Integrator (ODI) based ELT. This migration is planned in a phased manner, spanning across several releases over a period of time. During this migration cycle, ETL for some of the source applications will continue to use Oracle Warehouse Builder while others will use Oracle Data Integrator.

Note: For information about the new and enhanced products, see *Oracle Utilities Analytics for Oracle Utilities Extractors and Schema and Oracle Utilities Analytics Dashboards Release Notes*.

Visit My Oracle Support (<http://support.oracle.com>) for the most recent service packs and patches for this release to ensure you have the most current version of this product.

Chapter 2

Overview of Data Warehouse

The data warehouse is a database primarily used for reporting and analysis purpose. It is a central repository for the current as well as the historical data from various operational applications. Data from transactional or operational applications is extracted, transformed, and loaded into the star schema in the data warehouses.

The components of a typical data warehouse environment are:

- **Source Application** - The source application from where the data is transferred to the data warehouse.
- **ETL/ELT** - The Extract, Transform and Load (ETL) tools move the data from the source application to the target data warehouse.
- **Staging Area** - The staging area is a database that stores the raw data extracted from the source application.
- **Data Presentation Area** - The data storage architecture in the data warehouse, such as the star schema.

Source Application

The day to day transaction of the system is captured in the source application. The data in the source application is stored in a way that allows for fast reads and updates. Queries are not expected to be in bulk form, but typically arranged, row by row. To achieve this, the data is stored in a normalized form in the source application. Generally, the source system does not store historical data.

ETL/ELT

The process of identifying data to be transferred from the source to the data presentation area, extracting the data, and transforming and loading into the data warehouse is called Extraction, Transform and Load (ETL). There are many tools available in the industry. Based on the complexity of the ETL, you need to choose the tools or write the ETL programs.

Staging Area

Data warehouse stores data from various operational sources. The staging area is a database that stores the raw data extracted from the source application. The replication area is similar to the source application in the structure. This area can be used for cleansing the data, resolving domain conflict, merging or combining data from the multiple source applications, data duplication, etc.

Data Presentation Area

Once data is cleansed in the staging area, it is ready to be moved to presentation area. The data is organized in such a way that it is easily available for the presentation. The data is stored in dimensional model, typically in the star schema.

Chapter 3

Overview of Oracle Utilities Analytics

This chapter provides overview of Oracle Utilities Analytics (OUA), including:

- **What is Oracle Utilities Analytics?**
- **Overview of Analytics**
- **Data Processing**
- **Oracle Warehouse Builder Based Extract, Transform and Load (ETL)**
- **Oracle Data Integrator Based Extract, Load and Transform (ELT)**

What is Oracle Utilities Analytics?

Oracle Utilities Analytics (OUA) consists of pre-built analytics applications as well as a collection of Extractors and Schema products. Oracle Utilities Analytics products help you extract, transform, load, and analyze data generated in Oracle Utilities Applications, such as Oracle Utilities Customer Care and Billing (CC&B), Oracle Utilities Meter Data Management (MDM), Oracle Utilities Network Management System (NMS), Oracle Utilities Work and Asset Management (WAM), Oracle Utilities Mobile Workforce Management (MWM), and Oracle Utilities Operational Device Management (ODM).

Built on world class Oracle Business Intelligence Enterprise Edition (OBIEE) 11g platform with integrated spatial features, Oracle Utilities Analytics supports end to end analytic workflows including the ability to drill back to the source applications. The extractors and schema products are designed with pre-built mapping between source and target, and support schema extensibility with built in user-defined fields, dimensions and measures.

Oracle Utilities Analytics data warehouse is a separate database from the operational database. The data warehousing involves large volumes of data used primarily for analysis. The data warehouse has the following features:

- Data structures are easily accessible by end users for their reporting needs.
- Large volumes of data can be retrieved quickly. This in turn allows fast rendering of graphics that showcase the Key Performance Indicators (KPIs).
- Oracle Utilities Analytics contains star schemas and graphics suited for data retrieved from the various Oracle Utilities edge applications.
- Oracle Utilities Analytics application also provides you with the ability to add additional star schemas and graphics as per your requirement using the required development tools.
- Oracle Utilities Analytics can be divided into two broad components, namely, the Extract, Transform, and Load (ETL) process and the Analytics. Oracle Utilities Analytics uses Oracle Business Intelligence Enterprise Edition as its Analytics tool. The ETL is done using Oracle Warehouse Builder until Oracle Utilities Analytics version 2.4.0 release. This new release of

v2.5.0.0.1 has introduced Oracle Data Integrator based Extract, Load and Transform (ELT) for Oracle Utilities Operational Device Analytics, and Oracle Utilities Customer Care and Billing Analytics. In upcoming future releases of Oracle Utilities Analytics, most of the existing ETL will be moved to Oracle Data Integrator ELT in a phased manner.

In the release v2.5.0.0.1, the following products use Oracle Warehouse Builder based Extract, Transform, and Load (ETL):

- Oracle Utilities Work and Assets Analytics
- Oracle Utilities Outage Analytics
- Oracle Utilities Meter Data Analytics
- Oracle Utilities Mobile Workforce Analytics

The following product uses Oracle Data Integrator based Extract, Load and Transform (ELT):

- Oracle Utilities Operational Device Analytics
- Oracle Utilities Customer Care and Billing Analytics

Overview of Analytics

Oracle Utilities Analytics (OUA) comes with a rich set of pre-built analytics created using Oracle Business Intelligence Enterprise Edition (OBIEE). These analytics offer a detailed insight into vital Key Performance Indicators (KPI) for the various source applications.

These analytics are built on the top of various star schemas that are delivered in the data warehouse for different source application. For better performance, these analytics have been optimized to retrieve data from specially designed materialized views in the data warehouse. These materialized views are highly optimized to summarize data efficiently and make data retrieval much faster.

The pre-built analytics are created for each source application and grouped as separate catalog files as per the application. These product based catalogs are licensed individually.

Using the Oracle Business Intelligence Enterprise Edition Admin tool, a metadata repository is first built using the star schemas available in the Oracle Business Intelligence data warehouse. This repository file consists of three distinct layers:

- **Physical Layer:** Contains information about physical data sources.
- **Business Layer:** Contains the business logic for the fields
- **Presentation Layer:** Tables grouped as subject areas for fact based reporting

Once the repository file is created and deployed on Oracle Business Intelligence (BI) server, the dashboards are created based on subject areas from the presentation layer. These dashboards are saved in the various web catalog files.

Below is a high level architecture diagram for Oracle Business Intelligence Enterprise Edition components.

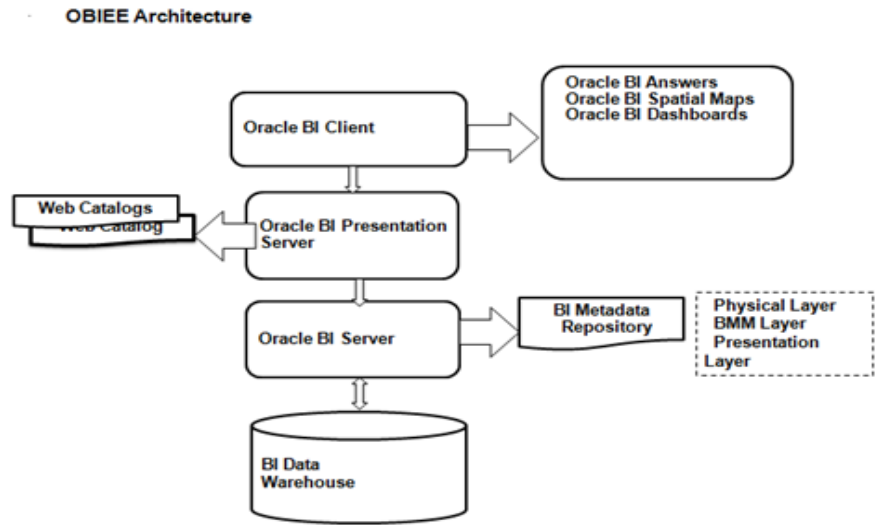

When Oracle Utilities Analytics product is shipped for the analytics portion, the metadata repository and the source application specific catalog files are also delivered.

Note: For details on Oracle Business Intelligence Enterprise Edition, refer to *Oracle Fusion Middleware User's Guide for Oracle Business Intelligence Enterprise Edition*.

Data Processing

The architecture for Oracle Warehouse Builder based Extract, Transform, and Load (ETL) and Oracle Data Integrator based Extract, Load and Transform (ELT) is different. The diagram below illustrates the overall data processing pipeline using these two different methodologies.

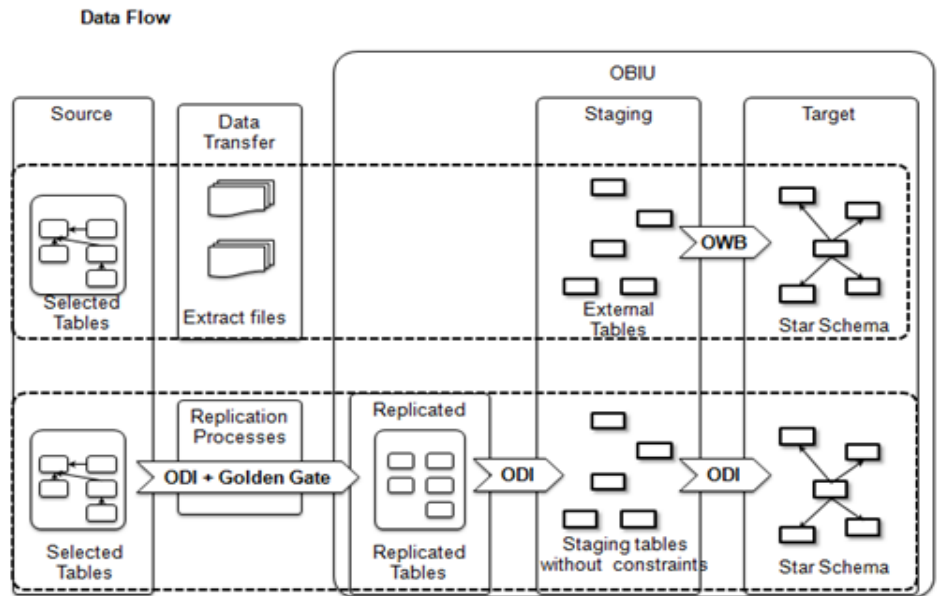

The following sections give an overview of both the architectures.

Oracle Warehouse Builder Based Extract, Transform and Load (ETL)

The Oracle Warehouse Builder based methodology uses a three phase approach where the source system extractors extract data into flat files. These files are transferred to the target system and from there, the Oracle Warehouse Builder process flows load the data into the target star schema.

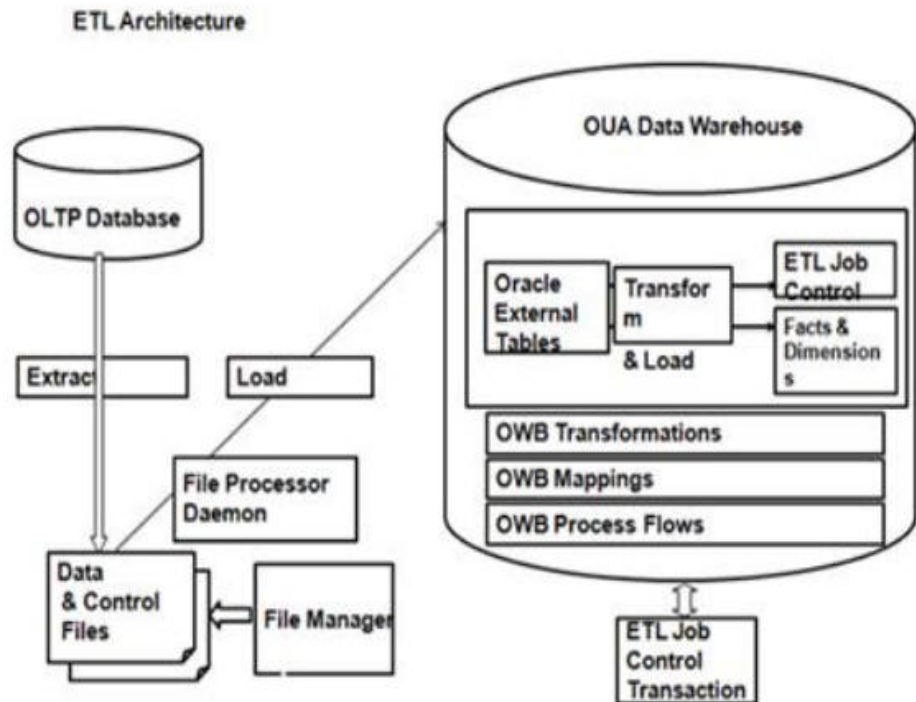

Oracle Utilities Analytics uses Oracle Warehouse Builder to store the following items:

- Table designs of the star schemas.
- Data mappings used to generate batch jobs that perform the extract, transform and load operations.
- Process flows that validate the extracted information, load the star schemas and perform exception handling.

The following processes are involved in this methodology:

- **Extraction**
- **Transfer**
- **Load**
- **Aggregation**

Extraction

The Extraction process executes on the source system and performs the transformations to convert data into a format that is accepted by the target data warehouse.

The Extractors are provided for the Oracle Utilities suite of products. The extract programs execute in the operational database as they are extracting operational data. Oracle Utilities

Analytics uses flat files as the source to load data into the data warehouse. The flat files are generated through an extraction process in the edge applications. Every fact and dimension in the data warehouse schema has a corresponding extract batch process. These batch processes extract data from the source system and transfer it to flat files. Along with each data flat file containing the extracted data, a single-record control file containing the batch information about the extractor program is also generated. The data and the control flat files, in turn, are loaded into Oracle Utilities Business Intelligence Data Warehouse.

Note: The Extractor programs are packaged with the edge applications.

Transfer

The data files generated on the source can be copied over to the target using FTP/SFTP/SCP or utilize a shared file location.

Load

The external tables in the target database point to these files and Oracle Warehouse Builder process flow loads the target data warehouse. Data validation and reference key transformations are performed by the load process.

The flat files produced by the extract programs serve as input to the load programs. The load programs use this data to populate the star schemas in the data warehouse.

Note: Refer to the **Appendix I** for complete information on Oracle Warehouse Builder based ETL and its components.

Aggregation

In this release, materialized views will continue to be used for storing aggregated data. However, the dependency on Oracle database's Query Rewrite feature has been removed, and Oracle Business Intelligence Enterprise Edition RPD is upgraded by providing a mapping between the subject areas and the different aggregations that can be utilized by fetching the data directly from the materialized views.

Oracle Data Integrator Based Extract, Load and Transform (ELT)

Oracle Data Integrator (ODI) is a comprehensive data integration platform that covers all data integration requirements ranging from high-volume, high-performance batch loads to event-driven, trickle-feed integration processes to Service-Oriented Architecture (SOA) enabled data services.

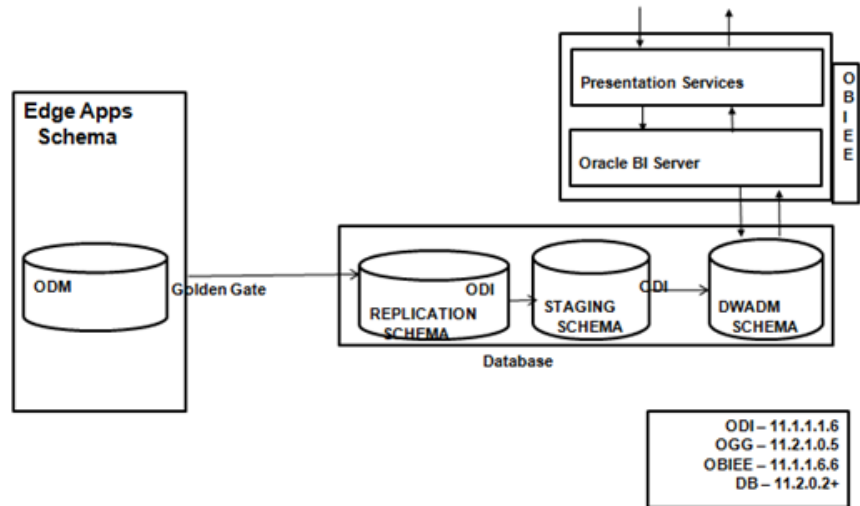

This methodology utilizes three key technologies from Oracle:

- Oracle Data Integrator
- Oracle GoldenGate
- Oracle WebLogic

The following concepts are involved in this methodology:

- **Replication**
- **Staging**
- **Target**
- **Data Cleansing**
- **Data Lineage**
- **Aggregation**

Replication

Oracle GoldenGate is utilized to replicate selected tables from source system into a replicated schema. Each source system instance has a dedicated schema associated for its replicated data. The replicated tables are similar in structure to the source tables with a few additional columns added for tracking history and audit.

Oracle GoldenGate processes capture any changes on the source tables and transfer them to the replicated tables. The changes are available in the replication layer within few seconds, and the data can be used to load the target data warehouse. Also, later on, if for any reason, you want to reset and reload data in the data warehouse, the data in replication layer is available, provided the data were not purged.

A replication area is present on the target data warehouse to store data with history. The replication tables are classified into three categories:

- **Historized:** These are master data tables where a change in any column of the source is stored as a new row. If a previous row exists with the same natural key and effective end date as the last date, then that the row is end dated.
- **Overwrite:** These tables do not retain historical changes. Any change in the source is considered as an update and existing rows are updated. Deletions are also treated as an update

and only the operation type is marked with a 'D' to indicate that the record has been deleted at the source. The transactional tables fall into this category.

- **Effective Dated:** Tables, which retain history in the source system. All changes are treated as updates. However, as source system does not store effective end dates, this value is calculated during sync.

The data area is also used to flatten out CLOB xml attributes into individual columns. The flattening out of CLOB into individual columns is done via views. These views also reside on the same physical schema on the database, but have a separate model in Oracle Data Integrator. It combines data from multiple tables together into a unified view that copies the target fact or dimension structure.

Staging

The staging tables are structurally similar to the target table and contain a few additional columns for data transformations. There are no constraints on the staging tables. The foreign key mapping and other transformations are performed in the staging area. The data retention in the staging area is controlled by configuration stored in the metadata.

Target

The final target is the data warehouse entities, namely, dimensions and facts.

Note: For additional information, refer to the *Oracle Utilities Analytics Data Mapping Guides* for the respective source application to star schema mapping.

Data Cleansing

The current release of Oracle Utilities Analytics v2.5.0.0.1 paves the way to enable custom data cleansing routines to be implemented. To support this feature, a column "**cleansed_flg**" is provided on the replicated tables. The value is set to 'Y' as default. Future release versions of Oracle Utilities Analytics product will provide a framework to utilize the cleansing feature for implementing custom cleansing rules. At present, the data load process does not check this flag while loading the data.

Data Lineage

When data is loaded from the source system into the data warehouse using Oracle Data Integrator (ODI), it is possible to use Oracle Data Integrator Lineage for Oracle Business Intelligence feature to consolidate Oracle Data Integrator metadata with Oracle Business Intelligence Enterprise Edition and expose this metadata in a report to the Source Data Lineage Dashboard in Oracle Business Intelligence Enterprise Edition.

Note: For configuration of Oracle Data Integrator Lineage, refer to the **Oracle Business Intelligence Enterprise Edition Data Lineage** section in the *Oracle Data Integrator 11g New Features Overview* white paper as this feature is not provided out of the box.

Aggregation

In general, most facts have high volume of data, and multiple dimensions for slicing and dicing data. This can potentially lead to performance issues in the summarized dashboards. To mitigate risks associated with performance, Oracle Utilities Analytics utilizes Oracle Materialized Views to pre-aggregate the data. Oracle Data Integrator interfaces are used to build the materialized views in the release 2.5.0.0.1.

For refreshing the materialized views, the following options are supported:

-
- **Scheduled:** The Materialized Views refresh is scheduled on a periodic basis to refresh the data in the materialized views based on the Oracle Integrator Scheduler using the configuration stored in metadata.
 - **Dependency:** The Oracle Data Integrator based scheduling mechanism is utilized to refresh materialized view after any of the dependent object been loaded.

The dependency on Oracle database's Query Rewrite feature has been removed, and Oracle Business Intelligence Enterprise Edition RPD is upgraded by providing a mapping between the subject areas and the different aggregations for fetching the data in the release 2.5.0.0.1.

Chapter 4

Configuring Oracle Utilities Analytics

Before you start using Oracle Utilities Analytics, it needs to be configured.

Follow the below-mentioned sections to configure the source system, ETL (Extract, Transform and Load), and analytics. It is extremely critical that you configure your system correctly for the product to behave as expected.

- **Configuring the Source System**
- **Configuring ETL/ELT**
- **Configuring Analytics**
- **Performance Recommendations**

Configuring the Source System

Based on the product and its associated ETL/ELT, you must have few configurations in place in the source system:

- **Oracle Data Integrator Based Extraction**
- **Oracle Warehouse Builder Based Extraction**

Oracle Data Integrator Based Extraction

Oracle Utilities Operational Device Management (ODM) and Oracle Utilities Customer Care and Billing (CC&B), which use Oracle Data Integrator based extraction, need certain parameters to be configured in the source system. Make sure that this is setup correctly.

Note: For more details on the parameters, refer to the **Configuration** chapter in the *Oracle Utilities Analytics Data Mapping Guides* of the respective source applications.

Oracle Warehouse Builder Based Extraction

The products, Oracle Utilities Work and Assets Management, Oracle Utilities Network Management System, Oracle Utilities Meter Data Management, Oracle Utilities Mobile Workforce Management use Oracle Warehouse Builder based extraction.

For each dimension and fact in the data warehouse, there is a batch program in the source system that extracts and transforms the required data based on the type of extract and parameters passed to the batch program. These batch programs extract data and place them in the flat files. Make sure that these batch programs are configured on the source system. A list of all the batch programs for the target entities is provided in the Appendices provided with this guide (starting from **Appendix D** to **Appendix G**). Other than the batch configuration, there may be additional

configuration required on the source application.

Note: For details on how to setup each of the source applications for data extraction, refer to the **Configuration** chapter in *Oracle Utilities Analytics Data Mapping Guides* for the respective source application.

Configuring ETL/ELT

Depending on the product you use, you need to configure Oracle Warehouse Builder (OWB) based ETL (Extract, Transform and Load), or Oracle Data Integrator (ODI) based ELT (Extract, Load and Transform).

This section describes the following:

- **Oracle Warehouse Builder Based ETL**
- **Oracle Data Integrator Based ELT**

Oracle Warehouse Builder Based ETL

The ETL for the following source applications are based on Oracle Warehouse Builder:

- Oracle Utilities Work and Assets Management
- Oracle Utilities Network Management System
- Oracle Utilities Meter Data Management
- Oracle Utilities Mobile Workforce Management

Once the extractor programs have generated the flat files for facts and dimensions, Oracle Warehouse Builder jobs pick these files and load the data into the data warehouse.

This section describes the following:

- **Scheduling Jobs Using the File Processor Daemon**
- **Log File**
- **Monitoring Jobs**
- **Handling Load Errors**
- **Capturing Fact Load Errors**
- **Fixing Load Errors**
- **Resubmitting a Failed Job**
- **Custom Error Handling**
- **Multiple Data Source Indicator Configuration**

Scheduling Jobs Using the File Processor Daemon

The File Processor daemon is a simple java based utility that copies the capabilities of a job scheduler. This persistent process runs continuously in the background and periodically monitors the extract folder. When new data files arrive, it processes them and triggers the appropriate Oracle Warehouse Builder process flows for loading the data.

It determines the fact dimension dependency. When a fact data file arrives in the extract file directory, it scans the extract directory to see if there are any data files present for any of the dimensions associated with this particular fact. If so, the loading of this particular fact file is skipped to let the dimension data load first into the data warehouse.

The File Processor daemon also scans the error folder to verify whether any of the dimension load jobs have failed. If there are failures, all the related fact data files are skipped from processing until

the related dimensions are loaded successfully. The fact / dimension dependency is determined through the database constraints table present in the data warehouse.

The mappings in the parameter file control how the File Processor daemon can determine which Oracle Warehouse Builder process to trigger for which data file and which table name to check while querying the constraints table for fact/dimension dependencies. For more details, refer to the detailed description of the parameter **extract.file.mappingN** mentioned below.

The installation of the standard setup for the File Processor daemon is documented in *Oracle Utilities Analytics for Oracle Utilities Extractors and Schema and Oracle Utilities Analytics Dashboards Installation Guide*. All standard process flows are configured to run with the base installation.

Note: For information on how to install and run the File Processor daemon, refer to *Oracle Utilities Analytics for Oracle Utilities Extractors and Schema and Oracle Utilities Analytics Dashboards Installation Guide*.

The File Processor daemon reads a parameter file “**SchedulerParm.properties**”, existing in the directory where the File Processor daemon is installed. The released version of this properties file includes entries for all standard process flows. Hence, if any of the base extract files are present in the extract load directory, these are processed automatically. No extra configuration needs to be done if only base extracts are being implemented.

The following required parameter entries are present in the delivered **SchedulerParm.properties** file, and can be modified if needed for an implementation by using the **configureEnv.sh/cmd** command as documented in *Oracle Utilities Analytics for Oracle Utilities Extractors and Schema and Oracle Utilities Analytics Dashboards Installation Guide*:

Parameter Name	Description
execution.switch	Determines if the File Processor daemon is active, or inactive. As long as this parameter is set to 1, the File Processor daemon continues to run. To stop the File Processor daemon without killing the process, modify this file, and set the execution.switch parameter to 0.
scheduler.poll.duration	Directs the File Processor daemon the number of seconds it should wait before polling the extract directory again to read the next set of the flat files to be loaded. By default, this is set to 60 seconds. However, based on the time it takes for the load jobs to complete, you can configure this value to a higher value (if load jobs take longer time), or a lower value (if load jobs complete real quick).
extract.dir.path	Directs the File Processor daemon where to look for new extract files. This path must match the path that the Oracle Warehouse Builder process flows have been configured to check for the extract files.

Parameter Name	Description
extract.max. parallel.threads	<p>Directs the File Processor daemon how many types of extract files (for fact or dimension tables) to load at a single time. If there are more files in the extract directory than the number specified by this parameter, the first set of files found are loaded with the current run of the File Processor daemon. This parameter can be modified based on the size of the machine/system and on the number of files that can be handled at once by Oracle Warehouse Builder.</p> <p>Note: For a single fact / dimension table, several flat files can be generated. However, multiple files for the same fact or dimension table will not be loaded in parallel. The load jobs have been configured to pick one file at a time for a fact or dimension table. The order in which they will be picked, will be the same order in which they were extracted from the source.</p>
extract.file.mapping.count	<p>Provides the number of process flows listed in the parameter file. This count must match the largest extract.file.mapping(N) present in the parameter file. If this count is set to a lower number than the number of mappings, then only the set number of mappings are processed by the File Processor daemon.</p>

Parameter Name	Description
extract.file.mappingN	<p>N is a number between 1 and the extract.file.mapping.count parameter, or extract.file.mapping.override.count parameter if this is specified. These parameters indicate the File Processor daemon, which extract files to look for, which process flow to run when an extract file is found and the actual table name in the data warehouse. The format of this parameter is Extract File Name, Process Flow Name, Table Name. The extract file name is just the base name without the data source indicator, batch number, thread number values and without the .DAT, or .CTL extensions.</p> <p>For example, this entry looks for the Account Extract files and runs the SPLWF_D_ACCT process flow when a new account extract file is found: extract.file.mapping1=D_ACCT_EXT,SPLWF_D_ACCT,CD_ACCT</p> <p>The table name is used for determining the dependency between the facts and dimensions by querying the database constraints table. This dependency check is required to avoid processing of any fact data files if any of its dimension data files are required to be loaded first. It is important when entering values that the N numbers increase sequentially and that no numbers are skipped. The largest N value matches the mapping.count or mapping.override.count parameter specified in the parameter file.</p>

Note: The following below-listed optional parameter is not present in the delivered **SchedulerParm.properties** file, but can be added if needed:

Parameter Name	Description
extract.file.mapping.override.count	<p>This parameter provides a way to override the mapping count specified in the extract.file.mapping.count parameter. The default parameter file does not include this parameter. If this parameter is specified, then the extract.file.mapping.count value is not used by the File Processor daemon.</p> <p>Note: When an override count is specified using this parameter, the additional mappings should also be specified after this using the previously explained parameter extract.file.mappingN.</p>

The important fields in the parameter file to look at when implementing new loads are the **mapping.count** and the **mappingN** parameters. The new loads can be added to the parameter file if these are implemented by a project. It is recommended that the new **mapping N** values to be entered at the end of the list so that during an upgrade process, it is easy to identify the added records when updating the newly released **SchedulerParm.properties** file.

After updating any of these parameters using the `configureEnv` program, you must run the `initialSetup.sh/cmd` script to create the `cm_schedulerParm.properties.exit_1.include` parameter file. You must place this file in the `<INSTALL_DIR>/templates` directory, and then restart the File Processor daemon. Refer to the following section for the steps to be done for the customization.

Steps to Customize the File Processor Mappings

For adding new mappings so that they can be processed by the File Processor, perform the following steps:

1. Create the "`cm_schedulerParm.properties.exit_1.include`" file under templates folder.

For UNIX:

```
$SPLEBASE/templates
```

For Windows:

```
%SPLEBASE%\templates
```

2. Add the following entry in "`cm_schedulerParm.properties.exit_1.include`" in the file:

```
extract.file.mapping.override.count = <COUNT_NUMBER>
```

Where `COUNT_NUMBER` is scheduler parameter mapping count from source parameter file (viz. `extract.file.mapping.count`) + user configurable mappings count.

For example:

```
extract.file.mapping.override.count = 251
```

3. Add the new user parameter mappings in "`cm_schedulerParm.properties.exit_1.include`" file.

Example:

```
extract.file.mapping250 = <MAPPING1>
```

```
extract.file.mapping251 = <MAPPING2>
```

Note: Refer to *Oracle Utilities Analytics for Oracle Utilities Extractors and Schema and Oracle Utilities Analytics Dashboards Administration Guide* for mapping format.

4. Run the **initialSetup** command.

For UNIX:

```
$SPLEBASE/initialSetup.sh
```

For Windows:

```
%SPLEBASE%\initialSetup.sh
```

5. Start the **File Processor**.

For UNIX:

```
cd $SPLEBASE/bin
```

```
nohup ksh ./startFileprocessordaeomon.sh > ../tmp/
```

```
consoleFileprocessordaeomon.log 2>&1 &
```

For Windows:

```
startFileprocessordaeomon.cmd
```

Log File

The instructions on how to start the File Processor daemon are explained in *Oracle Utilities Analytics for Oracle Utilities Extractors and Schema and Oracle Utilities Analytics Dashboards Installation Guide*. Once started, a log file called **FileProcessorDaemon.log** is written by the File Processor daemon. Messages from the File Processor daemon are written here for various normal activities. Error messages are also written to this file. If Oracle Warehouse Builder process flows are not triggered properly, review this log file to possibly identify the cause of the problem.

The log file is deleted once it reaches a size of 100 megabytes and a new file is started. Hence, if older errors are not showing up, then it is possible that the file may have been recently purged by the File Processor daemon.

Monitoring Jobs

Note: You must have full license of Oracle Utilities Analytics to use this feature.

The process flows that are run by the File Processor daemon are set up in two different ways depending on whether a fact or a dimension extract file is being loaded. For a dimension load, only the dimension file is loaded into the dimension table of the data warehouse. However, when a fact file is loaded, the fact table is updated, and then any associated materialized views are refreshed.

The load jobs are visible in the **ETL Job Control Administration** portal. This can be accessed by logging into the **Oracle Business Intelligence Enterprise Edition Dashboard** portal and navigating to **Dashboard > Administration > ETL Job Control**. The **Job Complete (JC)** status indicates that the data file is loaded successfully. If a fact is loaded, the **Job Complete** status does not indicate that the materialized views are successfully updated. An e-mail is sent to the configured recipient if the materialized view refresh fails, or if any of the load jobs fails.

The following attributes are available in the **ETL Job Control** portal:

- **Job No:** Indicates the unique number identifying the load process. A link is present on the value if the job status is 'ERROR'.
- **Batch Code:** The unique code identifying the extraction routine used to generate the extract files on the source system.
- **Description:** A descriptive name for the extract process.
- **Batch No:** The batch number indicates the batch in which the extract is run.
- **Batch Thread:** A batch can generate multiple files. Each file is identifiable by a thread number.
- **Start Date/Time:** Indicates the start time of the load process.
- **End Date/Time:** Indicates the end time of the load process.
- **ETL Job Status:** The current status of the job.
- **Data Source Indicator:** The unique identifier for each source system.
- **Load Audit ID:** A reference to the Oracle Warehouse Builder audit log tables.
- **ETL Map:** The Oracle Warehouse Builder mapping name that contains the code to load the data into the target.
- **Extract Record Count:** The number of records in the extract file.
- **Load Record Count:** The number of records loaded into target.
- **Load Error Count:** The number of records that failed.
- **Load Error Message:** Indicates the summarized error message identifying the cause of the job failure.

In addition, the load jobs and any associated errors can be viewed in Oracle Warehouse Builder Control Center. In general, if an e-mail message indicating a load failed is not received, then it indicates that the load of a data file (and any materialized view refresh) was successful.

Handling Load Errors

While loading data from flat files to target schema using Oracle Warehouse Builder, there are various reasons a load fails. This section describes attributes to check when trying to find out why an extract does not load or why an error is generated during a load.

Note: For details regarding resolving Oracle Warehouse Builder load problems, refer to *Oracle Warehouse Builder User's Guide*. You should turn off File Processor daemon before debugging.

- **Job Status:** Make sure that the jobs are not in an **In Progress (IP)**. The status of a job is stored in the **JOB_STATUS_FLG** field in the **B1_ETL_JOB_CTRL** metadata table available in the DWADM schema, or you can view the status on the **ETL Job Control Administration** portal in **Oracle Business Intelligence Enterprise Edition Dashboard (Dashboard > Administration > ETL Job Control)**.
- **Oracle Warehouse Builder Errors Details:** There are two views that you can query to see errors from a process flow: **ALL_RT_AUDIT_EXEC_MESSAGES** and **WB_RT_ERRORS** available in the B1REPOWN schema. These errors are present in the e-mail messages sent when a mapping fails. However, you can run the following SQL statements in the DWADM schema to view the errors stored from the last four hours if the email messages are lost or do not contain any error messages:

```
begin
owbsys.wb_workspace_management.set_workspace('SPLBIREP','BIREPOWN');
end;
-- where workspace name is SPLBIREP and workspace owner is
BIREPOWN;
-- replace if necessary the OWB workspace Owner in the query.
To find the Workspace Name and Owner, run:
select * from owbsys.WORKSPACE_ASSIGNMENT;
select to_char( created_on, 'dd-mon-yyyy hh24:mi:ss - ' ) ||
message_text
from all_rt_audit_exec_messages where created_on > sysdate - .2
order by message_audit_id;
```

- **Error RPE-02248:** If this error is encountered, then change the Runtime.properties file in the directory: \$ORACLE_HOME/owb/bin/admin.

```
-- Change the below settings from DISABLED to NATIVE_JAVA
property.RuntimePlatform.0.NativeExecution.FTP.security_constraint
= NATIVE_JAVA

property.RuntimePlatform.0.NativeExecution.Shell.security_constraint
= NATIVE_JAVA

property.RuntimePlatform.0.NativeExecution.SQLPlus.security_constraint
= NATIVE_JAVA
```

- **Strange Characters in Data Files:** After querying the external table if strange characters are viewed in the result set, then it shows that the character set may be specified incorrectly for the external file. The character set can be changed by running the **EditFFCS.TCL** file in Oracle Warehouse Builder. You can see the character set for a specific external file by running the following query:

```
select * from dba_external_tables
where table_name = 'STG_ACCT_CTL_EXT';
```

Note: For viewing the character set for a specific external file, specify the appropriate external table instead of the one mentioned in the example given above.

Note: Refer to *Oracle Utilities Analytics for Oracle Utilities Extractors and Schema and Oracle Utilities Analytics Dashboards Installation Guide* for more information on **EditFFCS.TCL** file and changing the character set.

Capturing Fact Load Errors

Apart from this out-of-the-box validation, Oracle Utilities Analytics also allows you to add additional validations to capture your business requirements.

In general, this process of capturing fact load errors is divided into two steps:

1. **Validation:** A validation function is invoked to execute the validation check. Oracle Utilities Analytics out-of-the-box validation validates the number of records loaded into the target file by comparing it with the number of records specified in the control file. You can write your own validation check if and when required. In case validation fails (as in case of out-of-the-box validation if number of records loaded into the target file is less than the number of records specified in the control file), the load is marked as an invalid load and a process to identify such records is executed.
2. **Error Identification:** This process executes certain queries to identify the records that failed to load and also the reason for the failure (missing reference records in a required dimension). All such records are inserted into a metadata table **B1_ETL_DATA_ERR** available in DWADM schema. This process can be customized to add the logic for identifying such records and making an entry into the **B1_ETL_DATA_ERR** table. The Out-of-the-box Oracle Utilities Analytics provides the error identification for foreign key reference only.

The following screenshot displays the reports, which are used to identify the failed load process:

Select	Job No.	Batch Code	Description	Batch No.	Batch Thread	Start Date / Time	End Date / Time	ETL Job Status	Data Source Indicator	Load Audit Id	ETL Map	Extract Record Count	Load Record Count	Load Error Count	Load Error Message
<input type="checkbox"/>	206	NETCOP	NET Customer Outage Fact (SUPPLY_NODE_LOAD)	1		1/7/11/2012 3:55:13 AM	7/10/2012 3:55:13 AM	ERROR		4	538 SPMAP_F_CUST_RECENT_OUTG	19854	0	1946	ORA-20001: INVALID_LOAD: Invalid number of records loaded into 'CF_CUST_RECENT_OUTG'. 0 Inserted, 66627 Merged and 0 Updated when 19854 changes expected. Transaction Rolled back.
<input type="checkbox"/>	210	EXTORLD	OMS Feeder Load Extraction (EXT_FEEDER_LOAD_INPO)	1		1/7/11/2012 12:58:10 AM	7/11/2012 12:58:13 AM	ERROR		4	680 SPMAP_F_FEEDER_LOAD_LOAD	20	0	20	ORA-20001: INVALID_LOAD: Invalid number of records loaded into 'CF_FEEDER_LOAD_LOAD'. 0 Inserted, 0 Merged and 0 Updated when 20 changes expected. Transaction Rolled back.
<input type="checkbox"/>	216	EXTWORKT	Extract Work Order Task	0		1/7/11/2012 3:05:11 AM	7/11/2012 3:05:11 AM	ERROR		3	715 SPMAP_F_WORORD_TX	4	0	4	ORA-20026: unable to get a stable set of rows in the source tables
<input type="checkbox"/>	216	EXTINC	OMS Call Transaction Fact (INCIDENTS)	1		1/7/11/2012 3:52:11 AM	7/11/2012 3:52:13 AM	ERROR		4	717 SPMAP_F_BST_CALL	2096	0	2096	ORA-00001: unique constraint (DWADM.SP4085) violated

In the screenshot above, the jobs have been filtered by the status = 'ERROR'. The report shows the number of rows in the data file and the number of rows loaded. Click the **Job No.** field to navigate to that particular error details page. This error details page shows the data, which is not loaded due to the error as shown in the screenshot below:

Sequence Number	Fact Natural Key	Error Description	Dimension Table	Dimension Natural Key	Update Date/Time	Data Source Indicator	Validation Procedure Name
4734798	SRC_ORDER_ID=073602468886	Foreign Key Validation Error	CD_PER	SRC_PER_ID=2270059560	12/15/2011 12:00:00 AM	170593 B1_ERR_F_ORDER	
4734799	SRC_ORDER_ID=010729467647	Foreign Key Validation Error	CD_ORDER_STATUS	ORDER_STATUS_CD=40	12/15/2011 12:00:00 AM	170593 B1_ERR_F_ORDER	
4734800	SRC_ORDER_ID=010729467647	Foreign Key Validation Error	CD_CAMPAIGN	CAMPAIGN_CD=CAMP-B	12/15/2011 12:00:00 AM	170593 B1_ERR_F_ORDER	
4734801	SRC_ORDER_ID=029629236090	Foreign Key Validation Error	CD_CAMPAIGN	CAMPAIGN_CD=CAMP-A	12/15/2011 12:00:00 AM	170593 B1_ERR_F_ORDER	
4734802	SRC_ORDER_ID=073602468886	Foreign Key Validation Error	CD_CAMPAIGN	CAMPAIGN_CD=CAMP-A	12/15/2011 12:00:00 AM	170593 B1_ERR_F_ORDER	
4734803	SRC_ORDER_ID=074673453728	Foreign Key Validation Error	CD_CAMPAIGN	CAMPAIGN_CD=CAMP-A	12/15/2011 12:00:00 AM	170593 B1_ERR_F_ORDER	
4734804	SRC_ORDER_ID=081903782811	Foreign Key Validation Error	CD_CAMPAIGN	CAMPAIGN_CD=CAMP-B	12/15/2011 12:00:00 AM	170593 B1_ERR_F_ORDER	
4734805	SRC_ORDER_ID=127894076175	Foreign Key Validation Error	CD_CAMPAIGN	CAMPAIGN_CD=CAMP-A	12/15/2011 12:00:00 AM	170593 B1_ERR_F_ORDER	
4734806	SRC_ORDER_ID=218333629527	Foreign Key Validation Error	CD_CAMPAIGN	CAMPAIGN_CD=CAMP-A	12/15/2011 12:00:00 AM	170593 B1_ERR_F_ORDER	
4734807	SRC_ORDER_ID=227027417307	Foreign Key Validation Error	CD_CAMPAIGN	CAMPAIGN_CD=CAMP-A	12/15/2011 12:00:00 AM	170593 B1_ERR_F_ORDER	
4734808	SRC_ORDER_ID=315237500330	Foreign Key Validation Error	CD_CAMPAIGN	CAMPAIGN_CD=CAMP-A	12/15/2011 12:00:00 AM	170593 B1_ERR_F_ORDER	

The screenshot above shows individual record level details.

The report provides the following details:

- **Fact Natural Key:** Indicates the unique key combination in the staging table.
- **Error Description:** Indicates the error type description.
- **Dimension Table:** The dimension table for which a reference could not be resolved in case the error is foreign key reference issue.
- **Dimension Natural Key:** The natural key columns and the data of the dimension, which are used to fetch the reference key in case the error is foreign key reference issue.
- **Update Date/Time:** The update date time in the extract file.
- **Data Source Indicator:** The data source indicator in the extract file.
- **Validation Procedure Name:** The procedure name that is used to identify these issues.

Fixing Load Errors

This section describes ways to fix the issues identified during error identification process. If a data file fails to load, it is moved to the error directory just below the load directory. The load directory can be accessed from the database server.

You can determine the directory path using the following query from the **DWADM** account and with the **Control Table** name that is included in the failed record:

```
SELECT directory_path
FROM user_external_tables a, all_directories b
WHERE a.table_name = UPPER( '&Control_Table_Name' ) AND
b.directory_name = a.default_directory_name AND
b.owner = a.default_directory_owner;
```

The easiest way to examine the data file that has errors is to copy it into the Load directory so that Oracle queries can be run against it. The extract file replaces the **.DAT** file in that directory with the file name.

For example, the <DIRECTORY PATH>/error/ D_ACCT_EXT01793300000001001.DAT file will replace the <DIRECTORY PATH>/ D_ACCT_EXT.DAT file. The **.CTL** file in the processed directory can also replace the **.CTL** file in the load directory.

Once you find the missing records, you can then determine if a required dimension key is missing from the dimension table.

Note: It is possible that a later dimension load could have added the dimension records after the fact table was loaded, so if no records are returned by any of these queries, then reloading the fact records may solve the problem.

There are several different ways to fix the data so that it can be loaded. The method used to successfully load the data depends on what has caused the error:

- Make sure that the dimension files are loaded successfully. If there are errors during the dimension load or the number of records loaded did not match the number of records in the file, then you may need to figure out why the dimension records did not load. Fix those and reload the dimension files, before you can start working on the reloading fact records.
- Fix a fact data problem issue in the source system. This allows the data to be re-extracted the next time the fact data is extracted.
- Modify the fact records to have valid dimension keys. If the fact records are modified, then these must be added to a new extract file to get reloaded. A manual extract can be done to create a new extract file, and then the modified records can be loaded to this file. The modified records are then loaded when the next load process is run.

Resubmitting a Failed Job

Note: You must have the full license of Oracle Utilities Analytics application to use this feature.

Resubmitting a Failed Job

Follow these steps to resubmit a failed job:

1. View the **ETL Job Control** page under the **Administration** menu of the dashboards.

Select	Job No.	Batch Code	Description	Batch No.	Batch Thread	Start Date / Time	End Date / Time	ETL Job Status	Data Source Indicator	Load Audit Id	ETL Map	Extract Record Count	Load Record Count	Load Error Count	Load Error Message
<input type="checkbox"/>	2006	NRTCCF	NRT Customer Outage Fact (SUPPLY_NODE_LOG)	1	1	7/10/2012 2:52:13 AM	7/10/2012 2:55:15 AM	RE-INITIALIZE	4	538	SPLMAP_F_CUST_RECENT_OUTG	19854	0	1946	ORA-20011: INVALID LO number of re into CF_CUST_RE 0 Inserted, : Merged and when 19854 expected. Tr Rolled back.
<input type="checkbox"/>	2009	EXTGRWA	OMS Crew Activity Extraction (CREW_EVENT_HISTORY)	1	1	7/10/2012 2:53:11 AM	7/10/2012 2:53:13 AM	JOB COMPLETE	4	561	SPLMAP_F_RST_CREW	40	40	0	
<input type="checkbox"/>	2010	EXTJOB	OMS Job Transaction Extraction (JOBS)	1	1	7/10/2012 2:54:10 AM	7/10/2012 2:54:18 AM	JOB COMPLETE	4	562	SPLMAP_F_RST_JOB	1436	1436	0	

2. Select the job that needs to be restarted and click on **Update** button provided at bottom of the report. This will change the ETL job status on the screen to **RE_INITIALIZE**.
3. Move the data and control files that errored out from the error folder to load directory folder. This is very important as the file processor does not process the files that are in the error folder.
4. Place the corrected files in the data folder and switch on the File Processor daemon. The corresponding process flow is triggered during the next polling of the file.

Custom Error Handling

Note that the out of the box validation is always going to be executed during every fact load. In addition to this out of the box validation, a user exit hook has been provided to allow you to write your own Customer Modification (CM) validation functions and error identification procedures. These customer modified functions and procedure should be created in the DWADM account based on the naming convention. The out-of-the-box fact load procedure automatically executes these functions/procedures if these objects exist in the database.

The list of all the existing validation functions and error identification procedures is provided in **Appendix G**. It also lists the custom function and procedure names to be used when extending the data load validation.

Note: You must use the exact name provided in the **Appendix G** for your custom validations to be called while loading the fact.

In general, it is advisable to follow closely the out of the box routine for the custom code. The following guidelines have to be followed when creating custom validation functions:

- The validation function name is derived from the built in validation function by replacing 'B1' with 'CM' in the name.

Note: Refer to the **Appendix H** for a complete list of validation functions for all facts. For example, for the fact **CF_CONSUMPTION**, the name of the out of the box validation function is **B1_VAL_F_CONSUMPTION**, and then the custom validation function name is **CM_VAL_F_CONSUMPTION**.

- The custom validation function has the same input parameters as those for the custom validation function. Follow the below template to create customer validation function:

```
CREATE OR REPLACE
FUNCTION CM_VAL_F_ << Custom Validation Function Name >> (
p_num_inserts IN NUMBER, p_num_merged IN NUMBER, p_num_updates IN
NUMBER)
RETURN NUMBER
AS
lv_ret_value NUMBER;
BEGIN
/* Your Logic Here */
EXCEPTION
WHEN OTHERS THEN
lv_ret_value := 1 ;
RETURN lv_ret_value;
END;
/*
```

The input parameters to the custom validation function are explained as below:

- **p_num_inserts:** Indicates the actual number of records inserted into target fact table by the mapping.
- **p_num_merged:** Indicates the actual number of records merged into target fact table by the mapping.
- **p_num_updates:** Indicates the actual number of records updated into target fact table by the mapping.
- The function returns **1** in case the validation fails and the load needs to be cancelled, and **0**, otherwise.
- The following guidelines have to be followed when creating custom error identification procedure. Always use the built-in procedure as a starting point:
- The procedure name is derived from the built in procedure by replacing 'B1' with 'CM' in the name.

Note: Refer to the **Appendix G** for the complete list of error identification procedures.

For example, for the fact **CF_CONSUMPTION**, the name of the out-of-the-box Error Identification procedure is **B1_ERR_F_CONSUMPTION**, and then the custom Error Identification procedure name is **CM_ERR_F_CONSUMPTION**.

- The custom procedures are the same input parameters as those of the out of the box procedures.
- Follow the below template to create the customer error identification procedure:

```
CREATE OR REPLACE
PROCEDURE CM_ERR_F<< Custom Error Handling Procedure Name >>
("IN_MAP_NAME" IN VARCHAR2, "IN_JOB_NBR" IN NUMBER)
IS
PRAGMA AUTONOMOUS_TRANSACTION;
BEGIN
/* Your Logic Here */
EXCEPTION
WHEN OTHERS THEN
ROLLBACK;
END;
```

The input parameters to the custom error identification procedure are explained as below:

- **IN_MAP_NAME:** Indicates the name of the mapping for which the procedure is getting executed for custom error record identification.
- **IN_JOB_NBR:** Indicates the job number of the particular mapping (as in **B1_ETL_JOB_CTRL** table) for which the procedure is getting executed for custom error record identification.
- The procedure must be executed as an autonomous transaction.
- The insert statement should be appropriately modified as per the custom validation implemented.

Multiple Data Source Indicator Configuration

Oracle utilities users can implement multiple utilities application leveraging the integration supported by these systems.

For example, Oracle Utilities Meter Data Management (MDM) and Oracle Utilities Customer Care and Billing (CC&B) joint implementations can leverage the MDM-CCB integration. Oracle Utilities Customer Care and Billing is used as the master repository for user related data (Account, Premise, Person, etc). So Oracle Utilities Meter Data Management instance does not store any user related information, but refer to the information in Oracle Utilities Customer Care and Billing instead. Similarly, Oracle Utilities Mobile Workforce Management (MWM) can be integrated with Oracle Utilities Meter Data Management and Oracle Utilities Customer Care and Billing. In this integration, Oracle Utilities Meter Data Management is used as the master repository for all meter and measurements related data. In the Oracle Utilities Business Intelligence data warehouse, the data for these objects is loaded from the master repository only. For example, Account, Person, Premise dimensions are loaded only from Oracle Utilities Customer Care and Billing and Oracle Utilities Meter Data Management fact may have a reference to the dimensional data loaded from Oracle Utilities Customer Care and Billing.

In this case, while loading the Oracle Utilities Meter Data Management data, the load process looks up for correct records in the dimension table loaded from Oracle Utilities Customer Care and Billing. Hence, there is a need to identify the Data Source Indicator (DSI) of Oracle Utilities Customer Care and Billing environment. Data source indicator is a unique value corresponding to each instance of an edge application feeding data into the data warehouse. The edge applications default the data source indicator from an environment ID. To support this requirement, Oracle

Utilities Meter Data Management and Oracle Utilities Mobile Workforce Management extract programs are enhanced to accept additional parameters for Oracle Utilities Customer Care and Billing DSI and Oracle Utilities Meter Data Management DSI. These additional DSI values are appended into the control file of the extract files. During data load in the warehouse, the load process uses Oracle Utilities Customer Care and Billing DSI to lookup and join to Oracle Utilities Customer Care and Billing specific dimensions, and Oracle Utilities Meter Data Management DSI to lookup and join to Oracle Utilities Meter Data Management specific dimensions.

Note: Refer to the *Oracle Utilities Analytics ReadMe* document for the required Oracle Utilities Meter Data Management and Oracle Utilities Mobile Workforce Management patches to support this feature.

Multiple data source indicator changes are covered in the detail below, including:

- **Multiple Data Source Indicator Changes for Oracle Utilities Meter Data Management Application**
- **Multiple Data Source Indicator Changes for Oracle Utilities Mobile Workforce Management**

Multiple Data Source Indicator Changes for Oracle Utilities Meter Data Management Application

This section describes how to configure the Oracle Utilities Customer Care and Billing DSI on Oracle Utilities Meter Data Management application. To configure, follow these steps:

Configuring Oracle Utilities Customer Care and Billing DSI on Oracle Utilities Meter Data Management Application

Perform the following steps:

1. Add a new feature configuration for the feature type '**Business Intelligence Configuration**'.
2. Select the option type '**External Data Source Indicator 1**' and enter the Oracle Utilities Customer Care and Billing DSI value. The Oracle Utilities Customer Care and Billing DSI value can be retrieved by running the below query in the Oracle Utilities Customer Care and Billing database:

```
select ENV_ID from F1_INSTALLATION;
```

During the ETL process, if Oracle Utilities Customer Care and Billing DSI is set in the extract staging control file, it is used to join with the matching DSI in the dimension table to match the dimension key. If the Customer DSI has not been extracted in the staging control file, then the default data source indicator are used.

For Oracle Utilities Meter Data Management source application, Oracle Utilities Customer Care and Billing DSI joins with Oracle Utilities Customer Care and Billing related dimension keys, such as Account key, Person key, Premise key, and Service Agreement (SA) key for the following facts:

- CF_CONSUMPTION
- CF_DEVICE_ACTIVITY
- CF_DEVICE_EVT
- CF_INSTALL_EVT
- CF_SP
- CF_SP_SNAP
- CF_SP_UT_AGE
- CF_VEE_EXCP

Multiple Data Source Indicator Changes for Oracle Utilities Mobile Workforce Management

This section describes how to configure Oracle Utilities Customer Care and Billing DSI and Oracle Utilities Meter Data Management DSI on Oracle Utilities Mobile Workforce Management application:

Configuring DSI on Oracle Mobile Workforce Management (MWM) Applications

Perform the following steps:

1. Add a new feature configuration for the feature type '**Business Intelligence Configuration**'.
2. Select the option type '**External Data Source Indicator 1**' and for the **Value**, enter the Oracle Utilities Customer Care and Billing DSI. The Oracle Utilities Customer Care and Billing DSI can be retrieved by running the below query in the Oracle Utilities Customer Care and Billing database.

```
select ENV_ID from F1_INSTALLATION;
```

3. Add one more entry with the option type as '**External Data Source Indicator 2**' and for the value, enter the Oracle Utilities Meter Data Management DSI. The Oracle Utilities Meter Data Management DSI can be retrieved by running the following query in the Oracle Utilities Meter Data Management database:

```
select ENV_ID from F1_INSTALLATION;
```

Oracle Utilities Mobile Workforce Management application can be integrated with Oracle Utilities Customer Care and Billing and Oracle Utilities Meter Data Management, and therefore two separate data source indicator columns have been added to Oracle Utilities Mobile Workforce Management fact staging control tables.

Oracle Utilities Customer Care and Billing DSI joins with Oracle Utilities Customer Care and Billing related dimension keys, such as Account key, Person key, Premise key, and Service Agreement (SA) key. Oracle Utilities Meter Data Management DSI joins with Oracle Utilities Meter Data Management related dimension keys, such as Contact key, Meter Device key, SP key, and US key for the following facts:

- CF_CREW_TASK
- CF_FLD_ACTIVITY

Note: The multiple data source indicator support is a new enhancement included in Oracle Utilities Advanced and Operational Spatial Analytics (OUASA) release 2.4.0 service pack 4. This feature is not supported in earlier releases of Oracle Utilities Analytics (OUA).

In previous releases, it was suggested to make Oracle Utilities Meter Data Management DSI same as Oracle Utilities Customer Care and Billing DSI to achieve the same functionality.

After this enhancement, it is not required to match Oracle Utilities Meter Data Management DSI with Oracle Utilities Customer Care and Billing DSI. Therefore, Oracle Utilities Meter Data Management and Oracle Utilities Mobile Workforce Management DSI values are defaulted from environment ID and are no more configurable. For users who are upgrading to this enhancement, a special upgrade script is provided.

For more details, refer to *Oracle Utilities Analytics for Oracle Utilities Extractors and Schema* and *Oracle Utilities Analytics Dashboards Installation Guide*.

Oracle Data Integrator Based ELT

The ELT for the following source applications are based on Oracle GoldenGate/Oracle Data Integrator:

- Oracle Utilities Customer Care and Billing (CC&B)
- Oracle Utilities Operational Device Management (ODM)

Oracle Data Integrator (ODI) based ELT uses Oracle GoldenGate and Oracle Data Integrator combination to extract, load and transform data from the source database to the target database. Oracle GoldenGate captures the changes in the selected tables of the source schema, and transfers these data to the replication schema. The tables in the replication schema are similar in structure to the source tables with a few additional columns added for tracking history and audit. Data retention in replication schema is controlled by configuration stored in the metadata.

Based on the scheduler configuration, data from replication schema is transferred by Oracle Data Integrator to the staging schema. The tables in the staging schema are similar to the tables in the target schema. It contains a few additional columns for data transformations. There are no constraints on the staging tables. The foreign key mapping and other transformations are performed in the staging area. The data retention in the staging schema is controlled by configuration stored in the metadata.

From the staging schema, Oracle Data Integrator transfers data to the facts and dimensions in the target schema. Oracle Data Integrator also loads and refreshes the materialized views in the target schema.

The required configuration for Oracle GoldenGate and Oracle Data Integrator is done during the Oracle Utilities Analytics installation process. Oracle Utilities Analytics provides an Administration tool to maintain these configurations. The following user interfaces are available as part of the Administration tool for maintaining various configurations.

- Product instance
- Oracle GoldenGate configuration
- Object map
- Global configuration
- Job configuration
- Dependency
- Check point
- Target entity
- Source table
- Job execution (Display only)

Note: For further information on how to use the Administration tool, please refer to the **Appendix B**.

This section describes the following:

- **Scheduling**
- **Job Monitoring**
- **Debugging**
- **Data Reload**

Scheduling

In any data warehouse, the basic challenge is to get the data loaded quickly and efficiently whether it is the initial load or the incremental load. Data volumes are high during initial load and during incremental loads the volumes are considerably smaller. The Oracle Data Integrator based ELT processes utilize a time based slicing mechanism to split the load volumes into more manageable slices to process the initial as well as incremental loads. The metadata configurations allow you to control the size of the slice, parallelism of the loads and much more. To ensure that the data loaded is always consistent, the process executions are governed by a set of rules. The following criteria are considered for the job execution:

- There should be no errors, which need reprocessing.
- The maximum retries limit for the day should not be exceeded or reached.
- Tasks wait for the configured retry interval before submitting a retry for the job.
- Number of parallel jobs is always being limited to the maximum parallel configured.
- Jobs are not executed beyond the time of the most recent GoldenGate sync, or to a specified cut off time whichever is less.
- If a job is dependent on tables, which are being synced by separate GoldenGate processes, then the common sync time of both processes is considered.
- If a scenario does not exist, then the jobs are not executed.
- An interface should be active.
- All dependencies should be run.
- The number of running/error instances of the job should be less than the maximum parallel executions allowed.
- If the instance is configured as run once, then it should not execute once it is successfully executed.
- If a job fails, it should be retried again until the maximum retries per day is reached. The interval between successive retries should be based on configuration.
- Oracle GoldenGate models comprising of the source tables used in the entity should have been synced up. In case, the sync timestamps vary across multiple models, then the maximum sync timestamp is used.
- The snapshot entities are executed on or after the snapshot end period.
- The schedule time can be used to stagger loads and distribute processing. A job is not being executed until the current time crosses the scheduled time.

Note: Refer to the **Target Entity** section in the **Appendix B** for where to schedule jobs.

All jobs executions are internally managed by the scenario named **B1_RUN_ALL**. This is scheduled using Oracle Data Integrator to run every 1-10 minutes as per your requirement.

Job Monitoring

As jobs keep running on a regular basis, these are monitored or tracked to ensure that the required performance parameters are met. Jobs are created so that these are capable of automatic re-execution and retries. However, reasons for failure should be looked into and appropriate actions should be taken to resolve those issues. The following views are provided for achieving this:

View	Purpose
b1_jobs_vw	Provides a list of jobs executed with details of the slice start and end, scheduled execution time, actual start and end times, status, and record counts.

View	Purpose
b1_config_vw	Consolidated view of the current configuration for all entities in the data warehouse.
b1_wait_reasons_vw	There are possibilities of erroneous configuration or other reasons due to which entities may not be running. To figure out what may be preventing a job from executing, have a look at this view's results.

Debugging

Oracle Data Integrator jobs are designed to make it easy to look at the data that was processed to figure out issues in the processing pipeline. To do this, the staging tables are utilized that retain data for a configured duration. Each execution results in some data that has been processed from the replication layer into the staging area, and then further on to the target entity. Each such set is stored in the staging table with the session number to identify the executing session.

At any point of time if a job fails, or you want to look at how data was before it was loaded into the target, you can query the associated staging tables to look at the data.

Staging tables names are derived by prefixing the target entity name with "STG_".

Data Reload

Data warehouses are usually designed based on the assumption that data is added only once to the warehouse. It is rare, although, sometimes to reset specific entities, the data is reloaded again. Oracle Utilities Analytics provides the functionality to reset and reload individual entities, or all data associated with a specific instance of a source system:

- **Resetting an Entity**
- **Resetting an Instance**
-
- **Resetting Range Lookup for Age Buckets**
- **Resetting Extract Parameters**

Resetting an Entity

Perform the following steps to reset an entity:

1. Login to **Oracle Data Integrator** client.
2. Navigate to the **Load Plans & Scenarios** section. Select the scenario named **B1_RESET_ENTITY**. Right-click and execute.

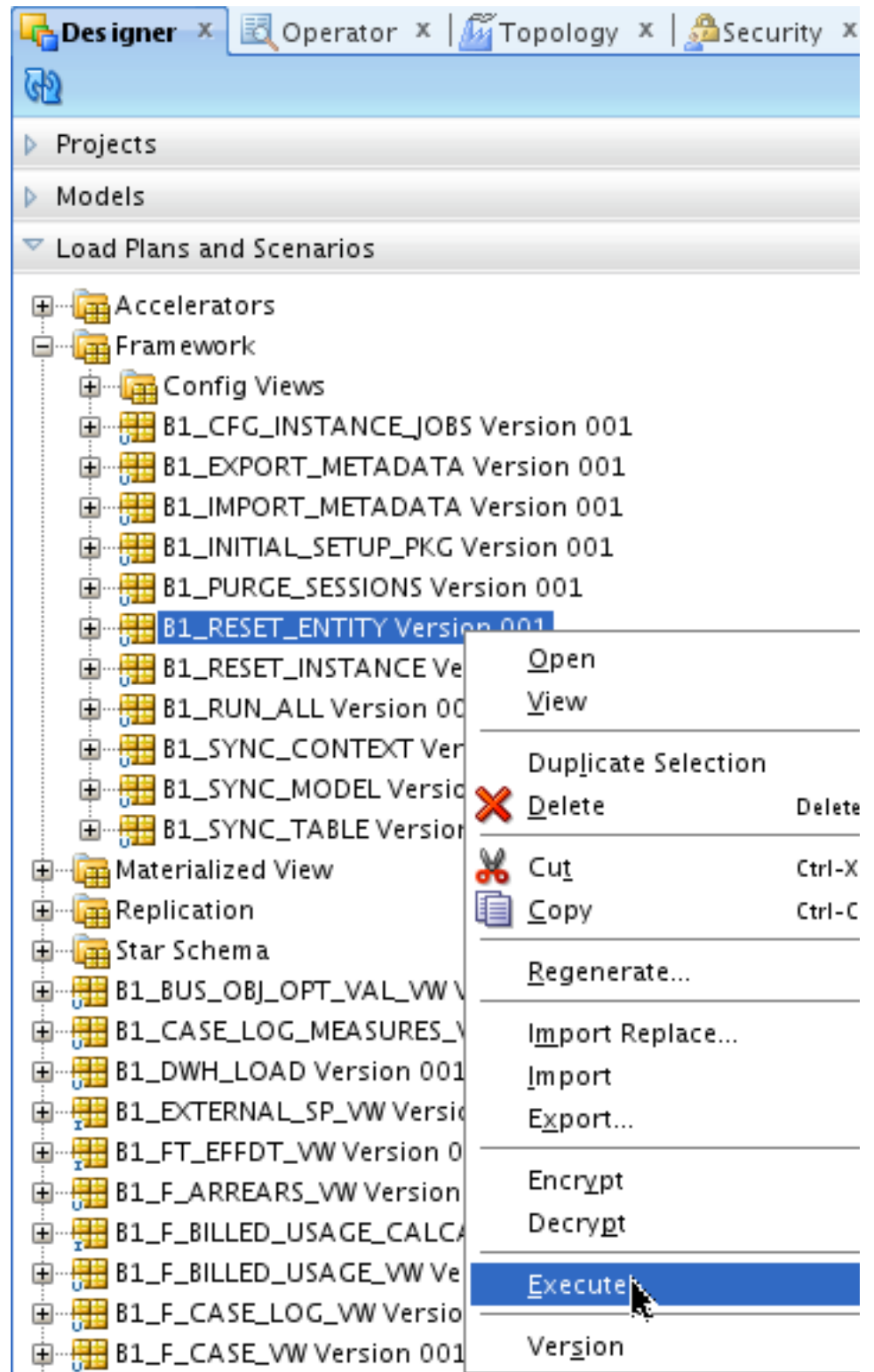

3. In the popup menu, select the context.
For example, if you want to reset the fact for Oracle Utilities Device Management product instance 1, select the context **ODM1**.

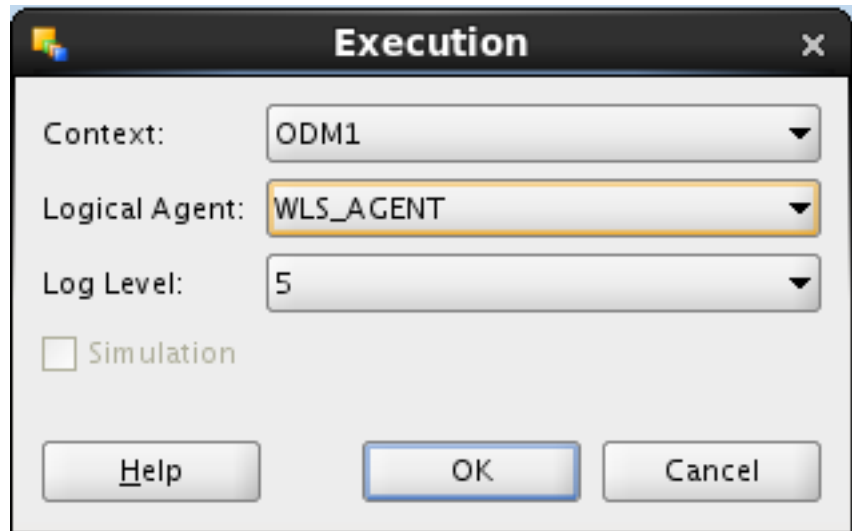

4. Uncheck **Last Value** checkbox, specify the variable value, and click on the name field before clicking **OK**.

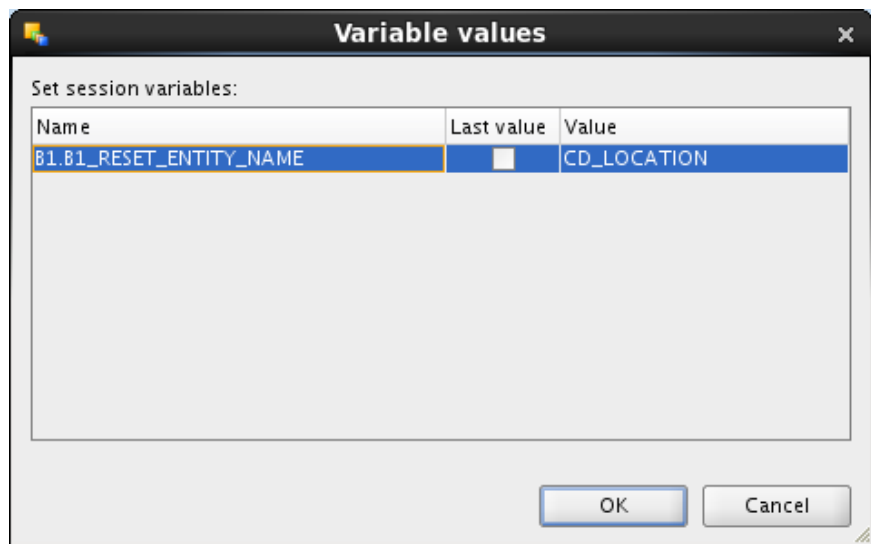

This will clean up the job executions and associated data. The entity will be in disabled state after the job is completed.

Resetting an Instance

Perform the following steps to reset an instance:

Note: The steps shown below to reset an instance should be used with care. The replication layer data should not be purged already, or else, the target does not load with the expected amount of data.

1. Login to the **Oracle Data Integrator** client.
2. Navigate to **Load Plans & Scenarios** section. Select the scenario named **B1_RESET_INSTANCE**. Right-click and execute.

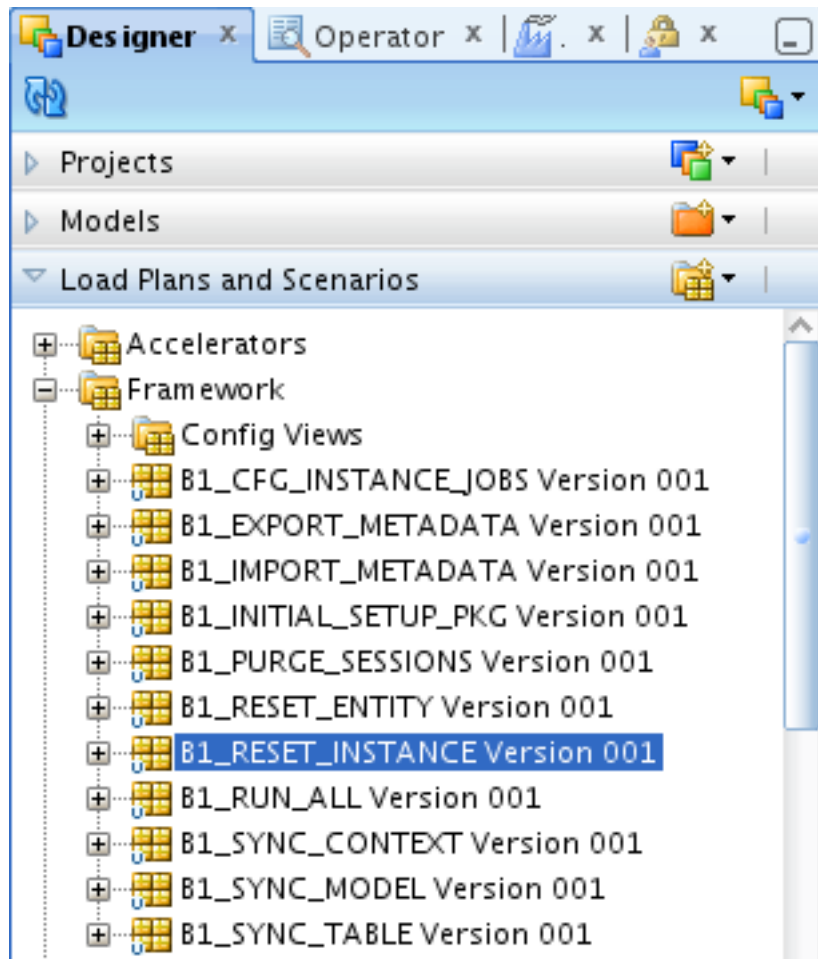

3. In the popup, select the context.
For example, if you want to reset all entities for Oracle Utilities Operational Device Management (ODM) product instance 1, select the context **ODM1**.

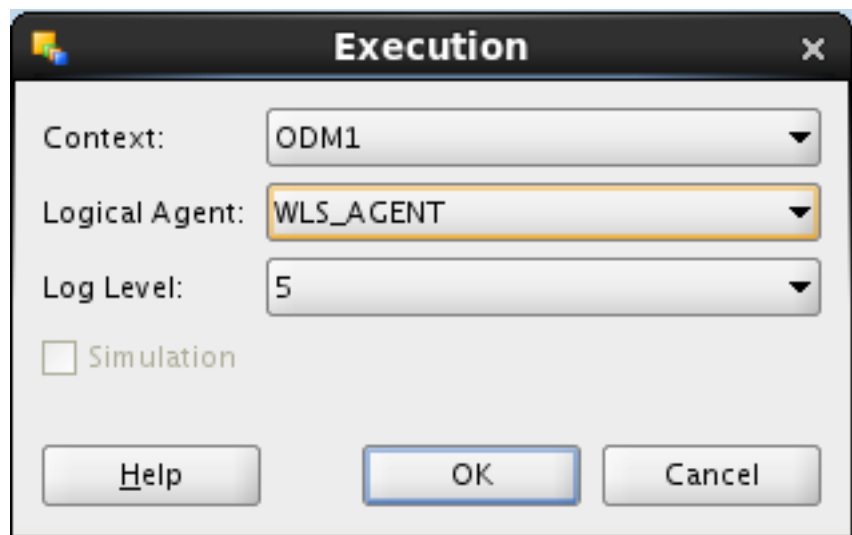

4. After verifying the configurations, enable all the entities you wish to load.

Resetting Age Buckets

Several key performance indicators in Oracle Utilities Analytics look at measurement values and classify the value into an age range. The analysts can use these metrics to review the ages classified into different groups, such as 0-30 days, 30-90 days, or 90+ days. Such age ranges configuration is usually done before the implementation, but there may be scenarios where you would like to change these age ranges.

The ELT jobs are configured to be initial load only. Any incremental changes to these buckets after the initial data load will not be reflected in the warehouse. However, if there is a need to reconfigure the buckets (If age buckets are associated with a dimension), perform the following steps:

1. Reset all the facts that are associated with the age bucket being re-configured using **B1_RESET_ENTITY** package.
2. Reset the dimension corresponding to the age bucket.
3. Reload the dimension.
4. Reload the facts.

Resetting Range Lookup for Age Buckets

This section is applicable for the age buckets, which are referenced by the fact ELT jobs.

The age buckets configured in the source, are loaded in the **MDADM.B1_RANGE_LOOKUP** table in the data warehouse.

The ELT job for this is configured to be initial load only. Any incremental changes to these buckets after the initial data load will not be reflected in the warehouse. However, if there is a need to reconfigure the buckets, perform the following steps.

1. Reset the facts that are associated with the age bucket to be re-configured. Refer to the section **Resetting an Entity** for more details. The fact names associated with various age buckets are mentioned in the table below.
2. Delete the entries from **Range** lookup table for the specific age buckets using the business object name mentioned in the table below.
3. Re-configure the age buckets in source.
4. To load the **Range** lookup table, run the view generator.

Note: Refer to the section “**Run view generator (Global)**” in *Oracle Utilities Analytics for Oracle Utilities Extractors and Schema and Oracle Utilities Analytics Dashboards Installation Guide* for processing configurations and regenerating views.

5. Enable the fact ELT job using the **Administration Tool** to start the data load.

Age Bucket	Business Object Name	Fact Name
PA Future Payment Age Configuration	C1-PAFuturePaymentAge	CF_PA, CF_PA_SNAP
PP Future Payment Age Configuration	C1-PPFuturePaymentAge	CF_PAY_PLAN, CF_PAY_PLAN_SNAP
SA Arrears Configuration	C1-SAArrearsBuckets	CF_ARREARS

Resetting Extract Parameters

If you need to modify the extract parameters defined on the source, perform the following steps:

1. Reset all the facts that are associated with the parameters being re-configured.
2. Modify the parameters on the source.

Note: Refer to the section **Run view generator (Global)** in *Oracle Utilities Analytics for Oracle Utilities Extractors and Schema and Oracle Utilities Analytics Dashboards Installation Guide* for processing configurations and regenerating views.

3. Reload the facts.

Configuring Analytics

This section describes the various Administration Dashboards and the details about configuration of dashboards.

- **Administration Dashboards**
- **Configuring Dashboards**

Administration Dashboards

This section describes the various reports available as part of Oracle Utilities Analytics administration dashboards.

The following dashboard pages are described in this section.

- **Base Field Maintenance**
- **Custom Field Maintenance**
- **Configuration**
- **ETL Job Control**

Base Field Maintenance

This dashboard allows you to provide an override description for the fields delivered along with the product. These fields contain descriptions, which appear on the report titles and the column titles for the dashboards delivered with the product.

Note: For the complete details on the field labels, refer to the **Label Configuration** in the section **Configuring Dashboards**.

Custom Field Maintenance

This dashboard allows you to define additional fields and your description, which you may want to add as a part of customization.

This dashboard has the following pages to allow you to add, edit, and delete your own fields:

- Update
- Insert
- Delete

Note: For the complete details on the field labels, refer to the **Label Configuration** in the section **Configuring Dashboards**.

Configuration

This dashboard provides pages for you to configure the Drill Back URL and map related configuration. The two pages in this dashboard are described below.

- **Source Drill Back**
- **Map Profile**

Source Drill Back

This dashboard page allows you to provide the source application details for Oracle Utilities Analytics product integration. The source application details, such as hostname, port number, and context are entered in this dashboard page. These details can be entered for Oracle Utilities Meter Data Management and Oracle Utilities Mobile Workforce Management edge applications depending on which application is being used.

This information is used by reports in the detail pages for providing a link back to a specific source application page.

Note: For more detailed information on drill back configuration, refer to the section **Configuring Drill Back**.

Map Profile

This dashboard page allows you to provide an override value for the map profile configuration. These configurations are used by maps available in the Outage Analytics Dashboard.

Note: For complete information on drill back configuration, refer to the section **Spatial Data Configuration**.

ETL Job Control

This dashboard page allows you to monitor the Oracle Warehouse Builder ETL jobs. You can track the status of the jobs along with its various attributes. During its lifecycle, when a job fails, you can resubmit the job for reprocessing using this page.

Note: For more detailed information on **ETL Job Control** page, refer to the section **Monitoring Jobs**.

Configuring Dashboards

This section describes the configuration dashboards in Oracle Utilities Analytics, including:

- **Configuring Drill Back**
- **Oracle Utilities Meter Data Management Analysis Configuration**
- **Label Configuration**
- **Spatial Data Configuration**
- **About Page**

Configuring Drill Back

Oracle Utilities Analytics provides multiple **Drill Back** functionality from various reports in Oracle Utilities Analytics to the source applications, such as Oracle Utilities Meter Data Management (MDM), Oracle Utilities Mobile Workforce Management (MWM), and Oracle Utilities Customer Care and Billing (CC&B). You must configure **Drill Back** by providing required information for this functionality to work.

The **Configuration Dashboard** under **Administration** group can be used for configuring various options in Oracle Utilities Analytics. The **Configuration** tab contains **Drill Back** settings for the source applications.

You can update the host name, port, and the context root folder for various edge applications with Oracle Utilities Analytics application through this page. After updating the values for the environment, the **Drill Back** links on various dashboard pages use these new values when an item is selected.

Currently, this drill back configuration supports the following edge applications:

- Oracle Utilities Meter Data Management
- Oracle Utilities Mobile Workforce Management

Note: You are required to configure only those source applications for which you have implemented Oracle Utilities Analytics.

Note: The **Drill Back Configuration** option for Oracle Utilities Customer Care and Billing and Oracle Utilities Operation Device Management is not available. Since the ELT methodology for these source products are based on Oracle Data Integrator, the source Drill Back URL is provided as a part of the **Product Instance** configuration in Oracle Utilities Analytics Administration tool. For further information, refer to the **Product Instance** section in the **Appendix B**.

Oracle Utilities Meter Data Management Analysis Configuration

The following Oracle Utilities Meter Data Management Answers should be configured before viewing the data:

- Tamper Events Answer (**Overview** dashboard)
- Usage Unreported for > 30 Days (**Overview** dashboard)
- Percent of Normal Intervals (**Overview** dashboard)
- Percent of On-Time Intervals (**Overview** dashboard)
- Degree Days (**Overview** dashboard)

After customizing the answers, save the reports in a separate CM catalog.

Note: For details, refer to *Oracle Utilities Analytics Dashboards for Oracle Utilities Meter Data Analytics Metric Reference Guide*.

Label Configuration

This section describes how to create and customize the labels that appear in answers and dashboards.

Note: You must have the full license of Oracle Utilities Analytics to use this feature.

This section includes the following topics:

- **Overview of Labels**
- **Overriding Base Labels**

-
- **Supporting Multiple Languages**

Overview of Labels

Oracle Utilities Analytics uses labels for the columns and the tables in the delivered Oracle Business Intelligence Enterprise Edition repository file when displaying the columns in the **Presentation** folders for you. These labels are displayed in the answers for the columns on the dashboards. In addition, the answers are also titled based on labels stored in the metadata displayed in report titles, sub-titles, and other dashboard strings.

The main reason the application uses labels instead of hard coding the text values in the answers and RPD file is to support translation of the dashboards into different languages and allow easy overriding of the labels for users, if you wish to customize the field label.

For example, within an answer, the labels can be referred to by Oracle Utilities Business Intelligence server variables. For example, the **Device Activity - Distributions** report uses this variable in the title section of the answer:

```
@{biServer.variables['NQ_SESSION.B1_RPT_DEV_ACTI_DISTRIBUTION']}
```

The **B1_RPT_DEV_ACTI_DISTRIBUTION** label is defined in the **B1_MD_FLD** table in **DWADM** schema.

For the columns in the fact and dimension tables, the labels exist for every field. For example, the **UDF1_DESCR** column in the **CD_ACCT** table has the description of **Customer Class**, and the **Customer Class** label is displayed in the **Presentation** folder for this field.

Overriding Base Labels

There are several reasons that an implementation may want to update an existing label:

- A field may contain data that does not match the default extracted data for that field. In the **CD_ACCT** example, described in the above section, you may elect to store information other than customer class in the **UDF1_DESCR** field. If an extract change is made to the default **CD_ACCT** extract, then an implementation change in the label for the **UDF1_DESCR** field of the **CD_ACCT** table at one place will change the label in all the dashboards and answers that display that field. This reason also applies if data is extracted to a User Defined Field (UDF) field that is not already having a default population.
- Even if you use the default extract code, you may choose to use some other name for the extracted data other than the default name. In the **CD_ACCT** example, if you execute the field extracted into the **UDF1_DESCR** field account class instead of customer class, you can make this change at one place and have it updated on all dashboards and answers.
- You may want to provide multilingual labels for your users. Oracle Utilities Analytics application provides the labels to a user based on the language selected when logging into Oracle Business Intelligence Enterprise Edition, assuming that the language is present in the **B1_MD_FLD** table. An implementation can add its own translated fields, or can download supported language packs from the Oracle Software Delivery Cloud.

Note: The multilingual support is only provided for labels and not for the underlying data in the data warehouse. The data displayed in all database tables is not translatable from the extract language.

Supporting Multiple Languages

Oracle Utilities Analytics is released with default support for English labels on all the dashboards and answers. Both Oracle Business Intelligence Enterprise Edition and Oracle Utilities Analytics provide support for the multiple languages.

The default language on the **Login** page is English. However, you can select any of the supported language on the **Login** page, or can change the preferred language under the **Administration** menu to view dashboards in a different language. If you have not purchased and applied the specific language pack and if you select a language other than English, the default Oracle Business

Intelligence Enterprise Edition labels is still be translated in the selected language, but Oracle Utilities Analytics product specific labels appear in English.

Oracle Utilities Analytics may release various language packs depending on user demands. Hence, for the language that is already released, installing the language pack is sufficient for creating the labels needed by the dashboards.

To view the list of Oracle Utilities Analytics language pack applied on an environment, you can navigate to the **About Oracle Utilities Analytics** dashboard under the **About Page** in the Oracle Business Intelligence Enterprise Edition dashboards menu.

Contact your Oracle support representative to purchase a Oracle Utilities Analytics language pack for additional language support.

To update a label for a base field, use the **Base Field Maintenance** dashboard in the **Administration** portal.

- **Table Labels:** For records that have the **Table Name** field populated, but not the **Field Name**, this label is shown in the **Presentation** folder for the fields available in this table. For example, the **CD_ACCT** table has the label '**Account Dimension**' displayed in the **Presentation** folder wherever it is used.
- **Field Labels:** For records that have both the **Table Name** and **Field Name** fields populated, this label is shown in the **Presentation** folder and on answers whenever that field is used. For example, the **UDF1_DESCR** field in the **CD_ACCT** table has the label '**Customer Class**' displayed whenever it is used in an answer or when you select it from the **Presentation** folder when creating a new answer.
- **Report Labels:** Records that have a field name, such as 'B1_RPT%' and no table name value are used for the titles of answers in the dashboards. For example, the **B1_RPT_DEV_ACTI_DISTRIBUTION** label is defined to be '**Device Activity Distribution**', and this is displayed on the **Oracle Utilities Meter Data Management** dashboard when the answer is displayed.
- **Other Labels:** All other non-report labels that have a field name, but no table name is used for calculations that are computed in the RPD logical layer for display on answers. For example, the **B1_APPT_IND_SUM** label is defined to be '**Number of Appointments**', and is used in Oracle Utilities Mobile Workforce Management answers that compute the number of crew appointments based on the **Appointment Indicator** field in the **CF_CREW_TASK** fact table.

If a base field label should be changed, then the implementation team can query the required record on the **Base Field Maintenance** dashboard, populate a value in the **Override Description** field, and click **Update**. Once populated, the Oracle Business Intelligence Enterprise Edition Server must be restarted for the changes to take effect.

Spatial Data Configuration

This section describes how to configure mapping for Oracle Utilities Analytics. It includes the following topics:

- **Loading Geographical Data**
- **Integrating Mapping with the Network Management System Network Model**
- **Map Profile Configuration (For Oracle Utilities Network Management System Maps)**
- **Configure Google Map Tile Layer**
- **Implementing Maps**

Loading Geographical Data

In order to place information on a geographic map, data in the data warehouse must match geographic data (themes) that are configured in Oracle MapViewer.

The standard map answers delivered with Oracle Utilities Analytics include maps that query state, city, county, postal codes, and network model summary data. As Oracle Utilities Analytics does not have access to this spatial data (and as each user may require different spatial data), user must set up the geographic themes used in the maps.

Note: For details regarding setting up these standard spatial themes, refer to *Oracle Utilities Analytics for Oracle Utilities Extractors and Schema and Oracle Utilities Analytics Dashboards Installation Guide*.

The installation instructions refer to shape files downloaded from the US Census Bureau. However, the shape files can also be used for the state, city, county, and zip code boundaries. The only requirement is that the names of the geographic entities in the shape file should match the corresponding name in the **CD_ADDR** table. This is not usually a problem for postal code data, but can be an issue for city and county names, as different sources may use different names to refer to the geographic places. Make sure that after loading the **MapViewer shapefiles** that the names in the geographic tables match the names that are in the **CD_ADDR** table. If these do not match, then the maps may not display correctly.

Integrating Mapping with the Network Management System Network Model

Oracle Utilities Network Management System (NMS) provides a mechanism to create spatial themes in Oracle MapViewer for the entire electrical network model. The default implementation of Oracle Utilities Analytics does not provide links to these MapViewer themes. However, the maps can be modified in the **Outage Analytics Dashboards** to show the various elements of the network model on the **Outage Maps**. This section provides an overview of the steps needed to provide the network model on the **Outage Maps**.

Note: For details regarding the steps required to set up the Network Management System Model Build process, refer to *Oracle Utilities Network Management System Installation Guide*.

To build the network model in Oracle Utilities Network Management System, the model build process must be set up to populate the geometry columns. The detailed instructions for this can be found in *Oracle Utilities Network Management System Installation Guide*.

To ensure that the network model can be displayed without coordinate translations during runtime, one of the geometry columns should use the same projection coordinate system as the base map used by the **Outage Analytics Outage Maps**. If Oracle eLocation is being used as the base map, then this would be srid 54004.

Once the model build is set up to populate the geometry columns, themes for the various network model components must be built. For example, there may be a theme for transformers, another theme for conductors, and other themes as required to build the network model. Oracle Utilities Network Management System provides templates that help in setting up these themes, and a base product installation may have ten or more themes. For more details, refer to *Oracle Utilities Network Management System Installation Guide*.

After the Network Management System Network Model themes are set up, these can be either accessed directly from the outage maps of Outage Analytics, or can be copied to the MapViewer instance used by the Oracle Business Intelligence Enterprise Edition (OBIEE) Dashboards.

There following are the advantages of using either of the two options discussed above:

- If the Oracle Utilities Network Management System themes are accessed directly, then near real-time device status information can be displayed in the Outage Analytics Outage Maps. Caching affects the lag time of the status information. This can be a good or bad, depending on how the refresh frequency of the Near Real Time (NRT) outage information in the data warehouse is set. There may remain some information in the device status that is yet to be extracted. This may result in a mismatch between the database data and the spatial data.
- Display of the Oracle Utilities Network Management System themes require access to the Oracle Utilities Network Management System database; hence, if the database is down or

network access to the database is not available from the data warehouse database, then the Oracle Utilities Network Management System themes is displayed on the maps.

- There can be a performance impact on the Oracle Utilities Network Management System database if a large number of users are displaying the **Outage Maps** in the **Oracle Business Intelligence Enterprise Edition Dashboards**.
- If the themes are accessed through the Oracle Utilities Business Intelligence database, then a mechanism to periodically copy any changes to the network model from the Oracle Utilities Network Management System to Business Intelligence needs to be setup. The **DIAGRAM_OBJECTS** table along with the **Theme** metadata should also be copied.

For each theme defined in the Oracle Utilities Network Management System network model that should be displayed on an outage map, the static text for the answer should be updated to access that theme and provide a checkbox that will turn the theme on or off.

Note: If this change is done, the process described in the **Oracle Business Intelligence Enterprise Edition Customization** section should be followed. First create a copy of the answer that needs to be modified, edit that copy of the answer, and then modify the dashboard to access the copy of the answer instead of the released copy of the answer.

Consider the following example. You want to add two Oracle Utilities Network Management System themes named **'Transformers'** and **'Conductors'** to the Outage Map answer on the **Overview** tab of the **Outage** dashboard. If you edit the dashboard page, you will see that this answer is called 'Outage Demo' and exists in the / Shared Folders/Outage Analytics/Spatial Requests folder. To edit modify this answer, follow these steps:

1. Create a folder called **'Project Customizations'** or some other unique name in the /Shared Folders folder, and copy the outage demo answer into it.
2. Open the outage demo answer and edit the static text box.
3. In the static text box, edit the JavaScript code to add the new **Transformers** and **Conductors** themes. The following code should be added just before the **addLegendFilter** code. Set the **legendSelected** parameter to **'Y'** to display the network model themes when the map first opens up.

```
var parm11 = new Array();
parm11['nodeId'] = 'MapNode1';
parm11['legendLabel']='Show Transformers';
parm11['theme'] = 'Transformer';
parm11['legendSelected'] = 'N';
    addStaticThemeParameter (parm11);

var parm12 = new Array();
parm12['nodeId'] = 'MapNode1';
parm12['legendLabel']='Show Conductors';
parm12['theme'] = 'Conductors';
parm12['legendSelected'] = 'N';
    addStaticThemeParameter (parm12);
```

Note: Using the Firefox browser to edit static text sometime results in issues like not being able to view the complete static text. Hence, it is recommended to use Internet Explorer (IE) browser instead when editing the static text for the Map answers in Oracle Utilities Analytics.

Map Profile Configuration (For Oracle Utilities Network Management System Maps)

A separate page for the map configuration is available as part of the Oracle Utilities Analytics Administration Dashboards. Under the Oracle Business Intelligence Enterprise Edition dashboards menu, you can access the **Configuration Dashboard** and navigate to the **Map Profile** page. The **Map Profile** page contains configuration options for the 10g version of the maps used in the **Oracle Utilities Network Management System Dashboards**. The various

options are broadly classified into **Map** attributes and the **Theme** attributes. Out of the box these configuration options are supplied with a default value. But if you want to specify a different value, you can do so by providing an override value in the column provided.

Configure Google Map Tile Layer

Out of the box Oracle Utilities Analytics is configured to fetch the map tiles from Navteq. However, you can switch to Google as an alternative source for the map tiles.

Configuring Google Map Tile Layer

Perform the following steps:

1. Log onto the **MapViewer** console.
Sample URL:
`http://<host-name>:<port>/mapviewer`
2. Click the **Admin** and enter the credentials.
3. On the **Management** tab, click the **Manage Map Tile Layers**.
4. Create a new tile layer by selecting **Google**.

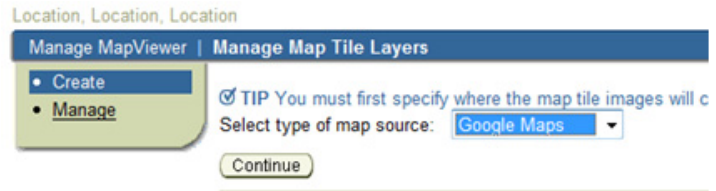

5. Enter the key fetched from Google in the **Key** field, edit the default **lib_url** to include the key value and choose the appropriate data source.

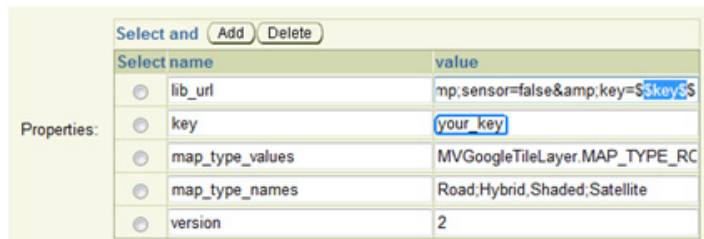

6. Click **Submit** to save the information.



7. Click **View map/Manage tiles** to verify the new tile layer shows up properly.
8. Click **Show Map** to view the map.
9. Logon to Oracle Business Intelligence Enterprise Edition Analytics and navigate to **Administration > Manage Map Data** and click on the **Background Maps** tab.

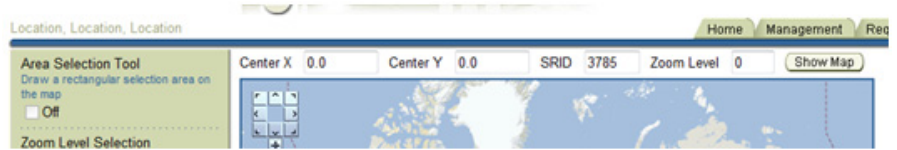

10. Import the tile layer 'GOOGLE_MAP' created on the **MapView** console.
11. Add layers to the map and save it.

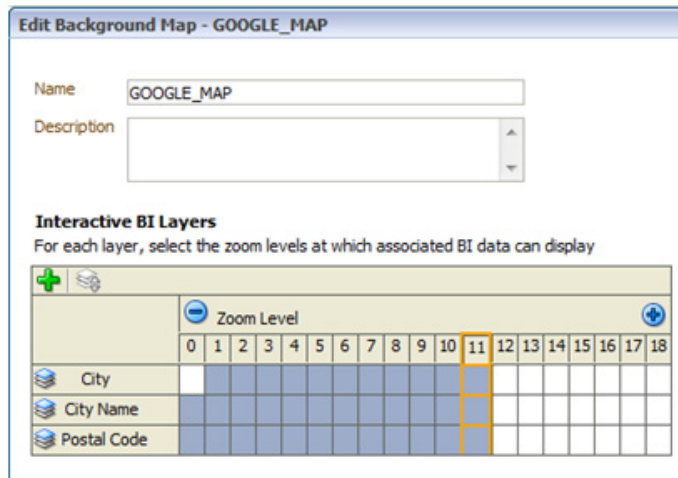

12. Subject areas will now be associated to the map.
13. Create a new answer and add a new map-view to have the data displayed on the map.

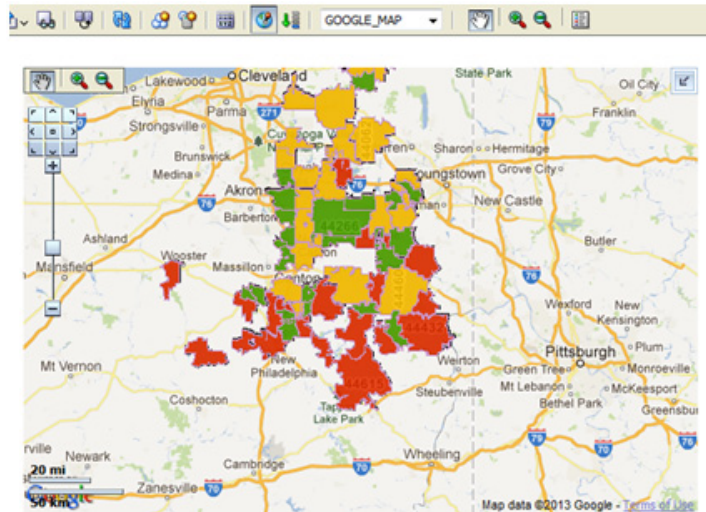

Implementing Maps

This section describes the two different methods of implementing maps in Oracle Utilities Analytics (OUA), including:

- **Standard Implementation Method**
- **Custom Implementation Method**

Standard Implementation Method

The standard implementation method is the default implementation method for Oracle Business Intelligence Enterprise Edition 11g. This form of map can be seen in various dashboards, such as Oracle Utilities Meter Data Analytics, Oracle Utilities Mobile Workforce Analytics, and Oracle Utilities Customer Care and Billing Analytics. Using this method, you can create new answers using the MapView. This view uses the configuration defined under the **Administration** menu in the **Manage Map Data**.

The layers, background maps, and the images being used in the map must be defined in this page. The key column and geographical columns are mapped for each subject area used in the analysis. This is a one-time setup unless new subject areas are added.

Note: You should not customize the map metadata until you import the Spatial Catalog file.

For customizations that involve map analysis, all the modifications must be done in a separate folder in order for those modifications to be preserved when upgrading Oracle Utilities Analytics.

Custom Implementation Method

The custom implementation method has been used for Outage Maps from the Oracle Utilities Network Management Analytics dashboards and is similar to the stand-alone **MapView** setup used in Oracle Business Intelligence Enterprise Edition versions prior to Oracle Business Intelligence Enterprise Edition 11g. The **Sets of Map** attribute and **Theme** profiles are provided to support this method. The Attribute profiles hold the data source information and the **Application Programming Interface (API)** keys. Theme profiles are used to map the **Geographic** column with the **Key** column.

Using the above method, you can:

- Create new answers using static text view with a call to the standard APIs along with the theme profiles that should be applied.
- Update theme profiles from the **Map Profile** page that is provided in the configuration dashboard. You can override the base values by using the **Override Value** column.

Note: No support is provided to create new theme profiles. The Upgrade scripts are provided to load the custom themes into the new configuration table.

About Page

The **About** page shows information about the product name along with the current release version and patch number. It also lists all of the languages that are currently installed in the product.

Performance Recommendations

This section discusses how to properly configure the database for partitioning and parallelism for better system performance.

Partitioning helps to scale a data warehouse by dividing the database objects into smaller pieces, enabling access to smaller, more manageable objects. Having direct access to the smaller objects addresses the scalability requirements of the data warehouses.

It takes longer to scan a big table than it takes to scan a small table. Queries against partitioned tables may access one or more partitions that are small in contrast to the total size of the table. Similarly, queries may take advantage of partition elimination on indexes. It takes less time to read a smaller portion of an index from the disk than to read the entire index. The index structures that share the partitioning strategy with the table, such as local partitioned indexes, can be accessed and maintained on a partition-by-partition basis.

The database can take advantage of the distinct data sets in separate partitions if you use parallel execution to speed up queries, Data Manipulation Language (DML), and Data Definition Language (DDL) statements. Individual parallel execution servers can work on their own data sets, identified by the partition boundaries.

The parallel execution enables the application of multiple CPU and I/O resources to the execution of a single database operation. It dramatically reduces response time for data-intensive operations on large databases typically associated with a Decision Support System (DSS) and data warehouses. You can also implement parallel execution on an Online Transaction Processing (OLTP) system for batch processing or schema maintenance operations, such as index creation. Parallel execution is also called 'Parallelism'. The parallelism involves breaking down a task so that instead of one process doing all of the work in a query; many processes do part of the work at the same time. For example, when four processes combine to calculate the total sales for a year, each process handles one quarter of the year instead of a single process handling all four quarters by it. The improvement in performance can be quite significant. The parallel execution improves processing for:

- Queries requiring large table scans, joins, or partitioned index scans
- Creation of large indexes
- Creation of large tables (including materialized views)
- Bulk insertions, updates, merges, and deletions

Note: For details on parallelism, partitioning, and other performance enhancement options, refer to *Oracle Database VLDB and Partitioning Guide 11g Release 2*.

Note: Refer to the section “**Deploying Oracle Warehouse Builder Workflows**” in *Oracle Utilities Analytics for Oracle Utilities Extractors and Schema and Oracle Utilities Analytics Dashboards Installation Guide* for setting the parallelism in materialized views and Oracle Warehouse Builder mapping.

Optimizing the Top N Answers

The Top N charts have to go through millions of records to find out the Top N objects that meet the criteria. Top N materialized views rearrange and partition the data so that the data reads are optimal. However, at times, depending on the amount of data, additional configuration may be required to reduce the size of the data set, which is being scanned in order to identify the Top N objects.

For example, a large sized utility with 6 million customers will have around 6 million service points in their Oracle Utilities Meter Data Management application. This means that the Consumption fact in the Oracle Utilities Meter Data Management star schema have several million records for every snapshot month. So, for each month level partition on the **Consumption Detail Level** materialized view, there will be several million records. The detail level pages (Top N Analysis and Unreported Usage Details) on the **Usage Summary** dashboard under Oracle Utilities Meter Data Analytics tries to access a huge volume of data, which can result in sluggish performance sometimes. The recommendation in such scenarios is to make a key prompt filter such as, 'City' as mandatory. This ensures the report looks at a smaller data set; thereby, improving the report performance. You can choose to make any set of filters mandatory as per your data requirement.

Chapter 5

Extending Oracle Utilities Analytics

The data warehouse schema in Oracle Utilities Analytics (OUA) covers a wide range of reporting requirements. You might often require to add additional data elements to meet site specific requirements. Oracle Utilities Analytics allows such extensions to the schema through the use of user-defined constructs, such as User Defined Fields (UDFs), User Defined Measures (UDMs), User Defined Degenerate Dimensions (UDDGENs), User Defined Foreign Keys (UDDFKs) and User Defined Dimensions (UDDs). Using these constructs, you can extend the star schemas that are delivered along with the product. With the additional data now available in the warehouse, the custom reports can be created in Oracle Business Intelligence Enterprise Edition (OBIEE) to leverage this additional data. Using these features, you can easily customize the product to suite your extended requirements. The following sections are described in this chapter:

- **Sample Use Case**
- **User Defined Columns**
- **Extending Star Schemas**
- **Customizing Analytics**

Sample Use Case

You look at the facts in a data warehouse by slicing and filtering the analytic data by different dimensions. For example, the following graph shows collectible sliced by the Customer Class field (the Collectibles fact is sliced by the Customer Class field on the Account dimension):

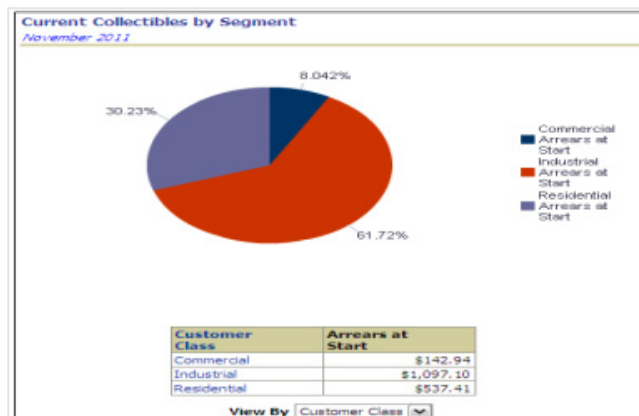

Whereas the below report slices the same fact by a different field on a different dimension (the City on the Address dimension). In addition, it limits the analysis to a specific customer class, i.e.,

Commercial. The below diagram shows how a single report can be sliced and filtered by different dimensional attributes.

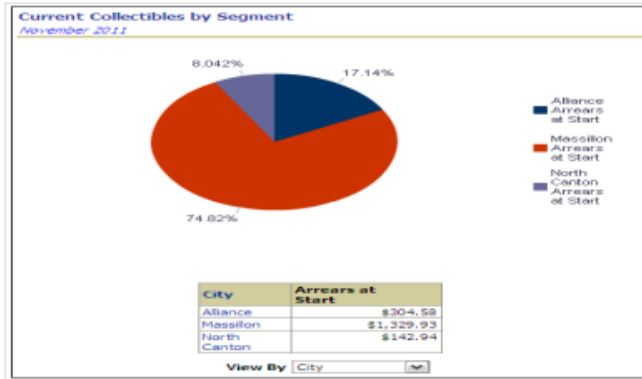

You can slice and filter a fact using any field on any dimension linked to the analytic's fact. For example, you can slice reports related to the Financial fact by any field on its dimensions. The following simplified data model of the Financial fact's star schema helps clarify this concept.

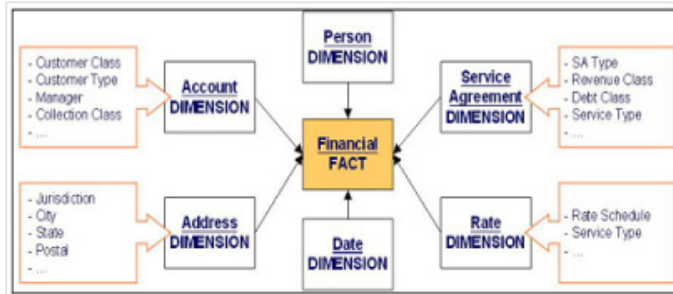

This data model shows that the Financial fact has six dimensions. This means that graphs can be configured to allow you to slice the Financial fact by any of the attributes on the six dimensions. For example, you can set up a report to slice the Financial fact by any combination of:

- The Account Dimension's Customer Class and Manager
- The Address Dimension's Jurisdiction
- The Service Agreement Dimension's Revenue Class
- The Rate Schedule Dimension's Rate

You can set up another report to slice and filter this fact by a different combination of fields. It should be noted that the above example is a simplified version. In reality, the most facts have more than six dimensions and most dimensions have several fields.

While Oracle Utilities Analytics allows you to slice and filter a fact by any field on its dimension, it also enables you to limit the number of fields on your report to a discreet group. This helps the materialized views that are configured, may make the system slow if these views contain too many fields.

User Defined Columns

The predefined facts and dimensions are provided with a set of user extensible columns, which can be used for extending the existing entities. These columns include:

- **User Defined Field**
- **User Defined Measure**
- **User Defined Degenerate Dimension**
- **User Defined Foreign Key Dimensions**
- **User Defined Dimension**

User Defined Field

The User Defined Fields (UDFs) reside on the dimension tables in the star schemas. In general, all the dimensions consist minimum of ten UDF columns. You can make of use of these columns to extract additional information from the source system.

Once configured appropriately, the ETL provided for the star schemas will automatically load the data into the appropriate columns.

You can change the User Defined Field (UDF) on your dimensions at a later date.

This UDF column feature allows all facts to be sliced and filtered by the newly added data in these user-defined fields. If you want to slice and filter historical facts by the new fields, you must update the historical dimensions to contain the current value of the new user-defined fields.

Note: Refer the section **Customizing Analytics** for adding the user-defined field in the report.

User Defined Measure

The User Defined Measure (UDM) column is used to reference the measures on the facts that you populate with implementation-specific measures.

A measure is a column on a fact that holds a measurable value. For example, the Financial fact has a measure that holds the amount of revenue produced by a bill. Most facts in the Oracle Utilities Analytics data warehouse have several measures. For example, in addition to the revenue measure, the Financial fact also has measures holding the total taxes and other charges on a bill.

For example, the following report shows several measures - score, revenue amount for the current, last, and the average revenue for the last three periods.

Status	Customer Class	Score	Revenue Amount	Last Year	Average Revenue Last Three Periods
	Commercial	70.36	\$694.42	\$986.90	\$826.31
	Industrial	114.09	\$6,063.22	\$5,314.54	\$6,578.76
	Residential	120.68	\$1,241.93	\$1,029.15	\$1,287.65

The facts and their extract programs are delivered with all of the relevant measures populated. However, if your implementation requires additional measures, you can populate User Defined Measure (UDM) column on the facts. To do this, you can introduce logic to the fact's extract program (in a user exit code) to populate one or more UDM column accordingly.

Note: No database, or Oracle Warehouse Builder (OWB) or Oracle Data Integrator changes are necessary as both the data warehouse and Oracle Warehouse Builder / Oracle Data Integrator are delivered in a ready state to support the newly populated UDM columns.

User Defined Degenerate Dimension

The User Defined Degenerate Dimension (UDDGEN) columns reside directly on the fact table and can be used to filter fact data in the same way as the User Defined Field (UDF). For example, the currency code columns are commonly used UDDGEN in Oracle Utilities Analytics application. These columns exist on most of the fact tables and can be used to limit the fact data shown in reports to a given currency code. Most fact tables in Oracle Utilities Analytics are delivered with multiple UDDGENs. These columns are populated by introducing user-exit code in the respective fact's extract programs. The main benefit of using UDDGENs in comparison to using UDDs is that UDDGENs can be populated in the fact's extract program and thereby, can reduce implementation time.

User Defined Foreign Key Dimensions

At times, there are requirements that can be easily satisfied by adding an existing dimension to a fact. For example, the Case fact is not delivered referencing the service agreement dimension. If you require analytics that slice and filter cases by service agreement dimensional attributes, you can configure the system to reference the existing service agreement dimension on the Case fact. The facts that support this type of extension contain columns called User Defined Foreign Key (UDDFK). If you do not see these columns on a fact, then it means that this functionality is not available in it.

User Defined Dimension

User Defined Dimensions (UDDs) are empty dimensions that are delivered along with the star schemas in Oracle Utilities Analytics. You can make use of these dimensions to extend the existing star schemas.

As described earlier, you can set up analytic reports to slice and filter a fact using any field on the dimensions linked to the fact. Oracle Utilities Analytics (OUA) delivers facts referencing the relevant dimensions. However, your implementation may need you to link additional dimensions to some facts. For example, the financial fact is delivered assuming that the revenue, tax, and expense amounts are aggregated regardless of the General Ledger (GL) accounts impacted by a financial transaction. If a given adjustment references six revenue GL accounts, all six revenue amounts are summarized onto a single Financial fact. This means that you cannot slice and filter revenue by specific General Ledger accounts.

If you have such a requirement to slice and filter an existing fact data using an additional group of related attributes, then you can opt to make use of these UDD tables. For each fact, two User Defined Dimensions (UDDs) are provided. These tables can be utilized for extending the star schemas. Five unbound UDD foreign key columns are also provided.

You can use user-defined dimensions only if the dimension does not change the granularity of a fact.

Extending Star Schemas

You can extend star schema without actually updating the table structure. This can be achieved by using the user-defined columns. The specific details on how to extend the star schema for a particular source product is dependent on the ETL methodology. The below-mentioned sections cover both Oracle Warehouse Builder and Oracle Data Integrator based approaches:

- **Oracle Warehouse Builder Based Extension**
- **Oracle Data Integrator Based Extension**

Oracle Warehouse Builder Based Extension

For the source applications whose ETL is based on Oracle Warehouse Builder, the customization starts from the source application itself where the data extraction is done. The following source applications make use of Oracle Warehouse Builder based ETL.

- **Oracle Utilities Work and Asset Management**
- **Oracle Utilities Meter Data Management and Mobile Workforce Management**
- **Oracle Utilities Network Management System**

Since different source applications employ different approaches to extract their data, the sequence of steps done for schema extension varies on the extraction approach as well. Once the extractors have been configured to pull the additional data, the Oracle Warehouse Builder ETL delivered along with Oracle Utilities Analytics product automatically loads these additional data into the warehouse.

The following sections cover the necessary steps to be done for each of the source applications.

Oracle Utilities Work and Asset Management

Oracle Utilities Work and Asset Management (WAM) uses the trigger-based approach to detect the changes on the base table that needs to be populated in the data warehouse.

Most of the extract programs support populating User Defined Field (UDF) and User Defined Measure (UDM) fields on their flat file records with specific fields from the source system. For example, you can set up the premise extract program to populate the first user-defined field on its flat file with the premise's city, county, or any address-oriented field.

You should specify to the extract program which fields require to be populated on the flat file by populating the batch process parameters. The number and type of parameters differ depending on the extract and type of information being extracted. However, in general, there are two types of fields that can be transferred to the flat file:

- **Columns:** Many dimensional extracts allow pre-defined columns to be populated on the flat file. For example, you can set up the premise extract program to populate the first User Defined Field (UDF) on its flat file with the premise's city, county, or any address-oriented column. An analogous concept is used to populate the User Defined Measure (UDM) on the fact extracts.
- **Characteristics:** Many dimensional extracts allow characteristics to be populated on the flat file. For example, you can set up the premise extract program to populate the first User Defined Field (UDF) on its flat file with the premise's tax characteristic, or/and premise-oriented characteristic.

Note: Most dimensional extracts support the population of their user-defined fields with characteristic values. A limited number of fact extracts allow characteristics to be used to populate user-defined measures. This is because most of the transaction files that trigger the fact extracts do not contain characteristics.

You can identify how an extract populates its user-defined fields and user-defined measures by populating parameters. Each user-defined field/ user-defined measure supported by an extract has two parameters that must be populated:

- **Type:** This parameter is defined or populated if the field is a true column or a characteristic. Enter PROG if you want to populate a User Defined Field (UDF) / User Defined Measure (UDM) with a column. Enter CHAR if you want to populate the User Defined Field (UDF) / User Defined Measure (UDM) with a characteristic.
- **Value:** This parameter defines the respective column or characteristic. To define a column, the value will be in the formation Table.Column (for example, CI_PREM.CITY_UPR - would be used on the address extract to populate a UDF with the upper-case format of an address's city). To define a characteristic, enter the characteristic's type code. Note, in the current release, only pre-defined value characteristics are supported.

Note: For details, refer to the relevant fact and dimension chapter in this guide for a description of each extract program and the various User Defined Field (UDF) and User Defined Measure (UDM) parameters that are supported in each.

Extracting Additional Fields

While the extract programs are delivered to populate their flat files with commonly used information, you may want to populate the User Defined Field (UDF) and User Defined Measure (UDM) with information not supported by the base-package.

Note: Refer to the **Appendix C** and the **Appendix D** for complete details regarding batch control and trigger names respectively while trying to customize the extracts.

Note: For additional details, refer to the knowledge article “Extending the OUBI Data Warehouse (Using User Defined Constructs in CC&B)” (Doc ID 1516838.1) available at the My Oracle Support website (<https://support.oracle.com/>).

Oracle Utilities Meter Data Management and Mobile Workforce Management

Oracle Utilities Meter Data Management (MDM) and Oracle Utilities Mobile Workforce Management (MWM) generally use the Sync Business Object (BO) based approach to detect the change in the source table that needs to be populated in the data warehouse. In some cases, where complex logics perform the extract, idiosyncratic batch processes perform the job.

Both of these approaches support the population of User Defined Field (UDF) and User Defined Measure (UDM) on their flat file records with specific fields from the source system. For example, you can set up the metadata in the source system to populate the first user-defined field on a service point dimension's flat file with the time zone, or any service point-oriented field.

A particular fact or dimension may fall into one of these two extraction styles. Both of them have their own ways of being extended. In both the methods, once the metadata has been configured appropriately, the respective batch controls run again to generate the new flat files with the User Defined Field (UDF)/User Defined Measure (UDM) columns populated.

Each fact and dimension use two types of approaches for extract:

- **Synchronization BO Based Extract**
- **Idiosyncratic Batch Extract**

Synchronization BO Based Extract

Each fact and dimension that uses the synchronization Business Object (BO) approach for extract has its own Sync Request business object. Each of these business objects has the following options:

- **Snapshot DA:** This is the data area, which contains the elements sent to the data warehouse. The elements in this Data Area (DA) are listed in the order in which the ETL expects them.
- **BO to Read:** This is the primary Business Object (BO). The contents of this business object are sent to the data warehouse. Its elements should match those in the Snapshot DA as it will be read, and then its contents “moved by name” to the Snapshot DA.
- **Element Population Rule:** These options are used to populate an element on the Snapshot DA that cannot be moved by name from the BO to read. The option value contains the following mnemonic:

Option Type	Sequence	Option Value
Element Population Rule	<A unique sequence number>	sourceElement=XXX populateTargetWithInfoString=true/false targetElement=XXX

The **sourceElement** attribute refers to an element in the Business Object (BO) specified in the option type 'BO to Read'. The **targetElement** attribute refers to an element in the Snapshot DA that needs to be populated. The **populateTargetWithInfoString** accepts a 'true' or 'false' value (a value of 'true' means that the sourceElement's foreign key reference in the BO to read schema will be used to retrieve the element's information string).

- **Post Service Script:** This is the script, which is executed after the Snapshot DA is populated with the BO to read elements and the element population rules (if any). It is responsible for populating elements on the Snapshot DA that cannot be derived directly from the business object to read.
You can extend the facts and dimensions by adding new options:
- **Element Population Rule:** To extend the element population rules, you should add new element population rule options following the mnemonic specified above. You can set up as many element population rules as you need, and the sequences do not matter.
- **Post Service Script:** To extend the post service script, you should create a new service script.

Option Type	Sequence	Option Value
Post Service Script for Extract	<A unique sequence number>	Custom Service Script Name

The option value to be supplied is the name of the customer service script, which has the logic to populate the User Defined Field (UDF)/User Defined Measure (UDM) columns with the desired values. There are few things to note here. First, the schema of the service script should match the schema of the Snapshot DA used in the Sync Request BO (this can be done by including the Snapshot DA specified on the Sync Request BO's option in the post service script's schema). Second, the post service script with the highest sequence number is executed. Hence, make sure to provide the appropriate sequence number on your custom service script. And lastly, because the highest-sequenced post service script will override any existing scripts, if Oracle Utilities Meter Data Management, or Oracle Utilities Mobile Workforce Management has been delivered with a post service script, your new custom service script should either execute the existing post service script (and avoid duplicating the same steps in your custom script), or not, depending on what you want to populate.

Idiosyncratic Batch Extract

For snapshot facts and certain dimensions, there are idiosyncratic batch jobs that are created to handle complex extraction logic.

- **Batch Parameters:** Certain batch jobs delivered as a part of the source system allow additional batch parameters for the end users to supply custom service script. The service script must include the same Snapshot DA defined as batch parameter on the batch job.
- **Algorithm Soft Parameters:** Certain algorithms delivered as part of the source system allow additional soft parameters for the end users to supply custom element population rules and service script. The usage of these parameter values is similar as explained for the 'Element Population Rule' and 'Post Service Script' above in the Synchronization BO-based style. The service script must include the same Snapshot DA defined as the soft parameter on the algorithm.
- **New Algorithm:** In case you need to drastically change the logic of populating the UDF/UDM columns or even the remaining set of fields in the flat files, you may wish to create a new algorithm and plug it in on the originating Business Object (BO). This algorithm is plugged in with a higher sequence than the base product algorithm. Additional care needs to be taken since this will completely override the existing algorithm logic and this new algorithm has the logic of populating the entire flat file.

Extracting Additional Fields

While the extract programs are delivered to populate their flat files with commonly used information, you may want to populate the User Defined Field (UDF) and User Defined Measure (UDM) with information not supported by the base-package. To do this, you must use the “Sync BO Options” to the respective extract objects.

Note: Refer to the **Appendix E** and the **Appendix F** for the complete details regarding **Batch Control** and **Sync BO Names** respectively while trying to customize the extracts.

Note: For additional details, refer to the knowledge article “Extending the OUBI Data Warehouse (Using Sync BO in Oracle Utilities Meter Data Management)” (Doc ID 1516859.1) available at the My Oracle Support website.

Oracle Utilities Network Management System

Oracle Utilities Network Management System uses the view-based approach to detect the change in the source table that needs to be populated in the data warehouse.

For any changes required in extracts, such as populating the user-defined field and user-defined measure with new column values, follow the below approach:

- Create new modify and delete views that have the business logic to extract the required data.
- Create a new extract program/procedure to access the view from above step. Ensure that the existing views/scripts are not updated as it might lead to upgrade impacts.
- Run the new extract program to retrieve data into the flat files.

Note: Refer to the **Appendix G** for the complete details regarding extract program and view names for customizing the extracts.

Configuring UDD Tables

If you have a requirement to slice and filter the existing fact data using an additional group of related attributes, then you can opt to make use of the user-defined dimension tables. For each fact, two user-defined dimensions are provided. These tables can be utilized for extending the star schemas. If you want to offer this option to your users, you must introduce these tables as additional dimensions to the existing fact (in addition, you must change the fact's extract program to extract as described in the earlier sections at this new level of granularity).

The following points below summarize how to set up a new UDD:

- You must create database trigger(s)/view(s) or Sync Business Objects (BO) to cause new and changed dimensions to be interfaced to the data warehouse. There are many examples of dimensional triggers in the operating system that can be used as samples for the new triggers.
- You must create a new program to extract the new dimension's values. This extract is executed in the operational system and will produce a flat-file containing the dimension's values. There are many examples of dimensional extract programs in the operating system that can be used as a basis of your new program.
- The flat-file produced by the extract is the input to Oracle Warehouse Builder. Oracle Warehouse Builder is delivered pre-configured to load the data warehouse from the flat-file.
- Run the new extract program in “extract everything” mode and let Oracle Warehouse Builder populate the dimension's rows.
- Return to Oracle Utilities Analytics and display the User Defined Dimension (UDD) table by updating the Oracle Business Intelligence Enterprise Edition (OBIEE) .rpd file. Enter the appropriate Override Label of each User Defined Fields (UDFs) on the table. Note these are the dimensional attributes that is used to slice and filter the dimension's facts. For example, if the dimension is meant to hold General Ledger (GL) accounts, define at least two user-defined dimension fields as shown below:
 - The General Ledger (GL) account number.
 - The General Ledger (GL) account type (for example, revenue, expense, tax, etc.).
 - Transfer to the operating system (for example, Oracle Utilities Customer Care & Billing) and introduce user-exit code to the extract program to the appropriate User Defined Dimension (UDD) values for the fact.

Refer to the **Source Applications** sections for the various approaches for more information about the extract programs.

When you extract the facts after this point, the flat-file supplied to Oracle Warehouse Builder is populated with the appropriate references to the User Defined Dimension (UDD).

Oracle Data Integrator Based Extension

Oracle Utilities Analytics (OUA) provides placeholder columns for user extension to out of the box star schemas. We have also provided a methodology that makes it easier for you to add logic to populate these user-defined columns. Refer to the section **Extending Star Schemas** in this chapter for details, which columns can be customized and what is the purpose of these columns.

The ELT for the following source applications are based on Oracle Data Integrator, and can be extended based on the steps described in this section.

- Oracle Utilities Customer Care and Billing (CC&B)
- Oracle Utilities Operational Device Management (ODM)

To start populating the additional user-defined columns, you should identify the source table, which is used to populate the target column. If the table is not in the list, follow the steps in the section below “**Extending Replication**” to add this table for replication.

The next step is to write a user extension procedure that can populate these columns. The interfaces have been created so that these perform additional actions, such as translating the source foreign keys to appropriate dimension keys.

This section covers:

- **Extending Replication**
- **Populating User-Defined Columns**

Extending Replication

Out of the box Oracle Utilities Analytics ships a required set of tables marked for replication. For extensibility purposes, additional tables may be configured to be replicated.

Configuring Additional Tables for Replication

To configure additional tables for replication, perform the following steps:

1. Check if the table to be replicated is listed in **B1_SOURCE_TABLE**.
2. If the table is not listed in the table, add an entry in **B1_OBJECT_MAP** setting the **SOURCE_OBJECT_NAME** as the table name and the **TARGET_OBJECT_NAME** as the target fact or dimension, which has some attributes loaded from this table.
3. The **SOURCE_OBJECT_NAME** can also be set to a Maintenance Object (MO) or Business Object (BO) in which case all tables comprising the Maintenance Object (MO) is pulled in.
4. Execute the scenario **B1_OUAF_CFG_METADATA**. Now an entry for this table will be present in the **B1_SOURCE_TABLE**.
5. Set the **CM_REPLICATE_FLAG** to 'Y'.
6. Execute the **initateSetup.cmd**, which creates a new model and the steps required for the replication process to be initiated.

For details, refer to *Oracle Utilities Analytics for Oracle Utilities Extractors and Schema and Oracle Utilities Analytics Dashboards Installation Guide* and check the section **Initiate Setup** under the chapter **Installation**.

7. Follow the instructions to set up the Oracle GoldenGate scripts generated to start.

Populating User-Defined Columns

Extending the data load process for populating the user-defined columns (UDF, UDM, UDDGEN and UDDFK) consists of the following steps.

1. Create a user exit procedure for the target entity in replication schema. The recommended naming convention is **CM_UDX_<entity_name>**.
2. The **User Exit** procedure signature supports three parameters. This is to ensure that the **User Exit** procedure works on a specific dataset only. The **User Exit** procedure updates the user-defined columns in the UDX table.
 - **V_SESS_NO**: This is the session number for processing. All SQL statements processing on the UDX table have a filter on the session number.
 - **V_SLICE_BEG_TS**: This is the slice begin timestamp. It is used for filtering data for the particular slice or snapshot. Data processed is greater than, or equal to this value.
 - **V_SLICE_END_TS**: This is the slice end timestamp. It is used for filtering data for the particular slice or snapshot. The data processed is less than this value.

Note: Refer to the section **Job Configuration** in the **Appendix B** to set the user exit procedure name.

For Example:

Below is a template code for extending an entity.

```
CREATE OR REPLACE CM_UDX_<entity_name>(
  v_sess_no      IN NUMBER
  , v_slice_beg_ts  IN DATE
  , v_slice_end_ts  IN DATE)
AS
BEGIN
  UPDATE UDX_<entity_name>  udx
```

```

SET udf1 = (SELECT <some_column>
            FROM <TABLE_A> src
            WHERE src.<nk1> = udx.<nk1>
                  AND src.<trx_date> >= v_slice_beg_ts
                  AND src.<trx_date> < v_slice_end_ts)
WHERE udx.sess_no = v_sess_no ;
END;
```

When writing the code for extending any target entity:

- **<entity_name>**: Replace with the appropriate target entity name. For example, CF_OPR_DEVICE.
- **<TABLE_A>**: Replace with the source table or tables that are required for fetching the source data.
- **<some_column>**: The source column to be used for populating the user-defined column.
- **<nk1>**: In the case of CF_OPR_DEVICE, the natural keys are SRC_ASSET_ID and DATA_SOURCE_IND.
- **<trx_date>**: Typically, this is the **update_dttm** column of the source table. However, depending on the functionality, this can be a transactional date column.

Note: The above- mentioned example on how you can select a value from one of the replicated columns. You can replace this logic by substituting code of any complexity as long as it returns the parameters mentioned above.

Customizing Analytics

This section describes how to use Oracle Business Intelligence Enterprise Edition (OBIEE) to customize Oracle Utilities Analytics. It includes the following topics:

- **Modifying the RPD file**
- **Customizing Answers**
- **Customizing Report Labels**

Modifying the RPD file

All customer modifications must be done in a separate repository file, which is separate from the product's out-of-the-box repository. Any customization done is merged into the upgraded repository file through the Merge utility of Oracle Business Intelligence Enterprise Edition (OBIEE) along with the product's out-of-the-box repository file.

Oracle recommends that you use a staging environment for the repository upgrade. However, as long as the customer modifications are done on the top of a copy of the base repository file, the Oracle Business Intelligence Enterprise Edition upgrade process is able to handle most customizations that may be made to the repository file. The simpler the changes, the less complex upgrade procedure; hence, you should try to limit the changes made to the repository file.

Note: For more information about managing, upgrading, and merging repository (.rpd) files, refer to *Oracle Business Intelligence Server Administration Guide*.

Customizing Answers

All user modifications are done in a separate folder in order to preserve these modifications for upgrading Oracle Utilities Analytics. If an existing answer needs to be changed to meet your requirements, a copy of the product report is created, and changes are made to the copy (not to the original report). The dashboard is changed to point, or refer to the new copy instead.

Note: The dashboards are overwritten during the upgrade. Any mappings between dashboards and customized answers are lost and must be re-mapped manually. Therefore, you should use a staging environment for upgrade and manually remap dashboards before moving the upgraded customized content into the production environment.

Note: For more details about managing, upgrading, and merging presentation catalogs, refer to *Oracle Business Intelligence Presentation Services Administration Guide*.

Note: For more details on how to create or edit answers, refer to *Oracle Fusion Middleware User's Guide for Oracle Business Intelligence Enterprise Edition*.

Customizing Report Labels

You can choose to opt for a different label or caption for an existing report or any of the report columns in it. You can provide an override description instead of the product provided description. These details can be provided in the **Base Field Maintenance Page** under the **Administration Dashboard** in the **Oracle Business Intelligence Enterprise Edition Dashboards** menu. Once the changes are saved and the cache is clear, upon the next login, the new descriptions can be seen on the report title or the column title.

Note: For more details, refer to the '**Administration Dashboards**' section in the **Chapter 4: Configuring Oracle Utilities Analytics**.

Chapter 6

Adding New Components

This chapter focuses on how customers can create new components, such as analytics, star schemas, and ETL/ELT processes to load them as per their additional requirements. The following topics are covered in this chapter:

- **Creating a New Star Schema**
- **Creating a New Oracle Warehouse Builder Workflow**
- **Creating a New Object for Oracle Data Integrator Based ELT**
- **Creating a New Analytics**

Note: This chapter serves as a developer's guide on how to create custom components on the top of the base product. Oracle will not support these components, or any issues that might arise. Thereof, you will have to develop and maintain these components independently.

Creating a New Star Schema

The star schema is perhaps the simplest data warehouse schema. It is called a star schema as the entity-relationship diagram of this schema resembles a star with points radiating from a central table. The center of the star consists of a large fact table. The end points of the star are the dimension tables.

A star query is a join between a fact table and a number of dimension tables. Each dimension table is joined to the fact table using a primary key to foreign key join. However, the dimension tables are not joined to each other. The optimizer recognizes star queries and generates efficient execution plans. It is not mandatory to have any foreign keys on the fact table for star transformation to take effect.

A typical fact table contains keys and measures. A star join is a primary key to foreign key join of the dimension tables to a fact table. The main advantages of a star schema are as follows:

- Provides a direct and intuitive mapping between the business entities analyzed by end users and the schema design.
- Provides highly-optimized performance for typical star queries.
- It is widely supported by a large number of business intelligence tools, which may anticipate or even require that the data warehouse schema contain dimension tables.

The star schemas are used for both simple data marts as well as very large data warehouses. Once the model has been designed, the Oracle Warehouse Builder Code Generator can be utilized to generate the mappings and process flows.

Note: For details regarding data modeling, refer to the **Chapter 19: Schema Modeling Techniques** of the guide *Oracle® Database Data Warehousing Guide 11g Release 2*.

Defining ETL for New Star Schema

Creating New Extractors

Since different source applications employ different approaches to extract their data, the sequences of steps that will have to be done for schema extension vary on the extraction approach as well. Once the extractors have been configured to pull the additional data, the Oracle Warehouse Builder ETL delivered along with Oracle Utilities Analytics product automatically takes care of loading these additional data into the warehouse. The following sections cover the necessary steps to be done for each of the source applications.

- **Oracle Utilities Work and Asset Management**
- **Oracle Utilities Meter Data Management and Mobile Workforce Management**
- **Oracle Utilities Network Management System**

Oracle Utilities Work and Asset Management

Oracle Utilities Work and Asset Management (WAM) uses the trigger-based approach to detect the change in the source table that needs to be populated in the data warehouse.

To populate the new facts/dimensions, perform the following steps:

1. Create new triggers that have the business logic to extract the required data from the new tables.
2. Create a new extract program/procedure to with the desired extraction logic from the change log tables.
3. Create new batch controls for the extract programs.
4. Run the new batch controls to extract data into flat files.

Note: Refer to the **Appendix C** and the **Appendix D** for existing Batch Control and Trigger Names while trying to create the new extracts.

Note: For additional details, refer to the knowledge article “Extending the OUBI Data Warehouse (Using User Defined Constructs in CC&B) (Doc ID 1516838.1)” available at the My Oracle Support website (<https://support.oracle.com/>).

Oracle Utilities Meter Data Management and Mobile Workforce Management

The source applications of Oracle Utilities Meter Data Management (MDM) and Oracle Utilities Mobile Workforce Management (MWM) make use of the Sync Business Object (BO) based approach for data extraction. For all the facts and dimensions other than those of snapshot type and certain dimensions with complex extract logic, it is advisable to use the Synchronization BO mechanism provided by Oracle Utilities Application Framework (OUAF). There are two options to extract new dimension or fact data.

This section covers:

- **Creating New Synchronization Request Business Object**
- **Creating an Idiosyncratic Java Batch Program to Extract Data**

Creating New Synchronization Request Business Object

Perform the following steps to create the new synchronization request Business Object (BO):

1. Copy an existing Sync Request BO.
2. Modify the following BO options in the newly created Sync Request BO:

- **BO to Read:** This needs to be populated with the BO, which has elements that need to be extracted.
 - **Snapshot Data Area:** This defines the schema, which is exactly extracted in the flat file, including the order of elements and the element types.
 - **Post Service Script:** If you want to extract data, which is not available in the schema BO to Read BO, you will have to write a processing script to extract such elements.
 - **Element Population Rule:** If you want to move data from an element defined on BO to read BO to another element defined in the Snapshot Data Area (DA), you can add the element population rule.
 - **Batch for Extract:** This is the name of the batch that needs to be executed to extract the flat files. It is recommended that you create a new extract batch control for your new fact or dimension, so you can define and default the parameters specific to your fact or dimension, but you should be able to use the existing extract java batch program.
 - **Star Schema Type:** Mention whether this Business Object (BO) is for a fact or dimension.
3. To handle initial synchronization, it is recommended that you create a new initial load batch control for your new fact or dimension if there is no existing one for the Maintenance Object (MO) of your ETL source. If there is an existing initial load batch control for the MO, add the newly created Sync Request BO as additional sync request BO batch parameter.
 4. To handle incremental sync, create an audit algorithm to define the logic to control the creation of pending sync request record. This should be plugged in on the MO of your ETL source. Refer to an existing audit algorithm delivered in the edge application. Depending on the audit algorithm created, add the newly created sync request BO as an option on the MO of your ETL source.

For snapshot type facts and certain dimensions with complex extraction logic, you can create an idiosyncratic java batch program to extract the data without using the sync request BO.

Creating an Idiosyncratic Java Batch Program to Extract Data

Perform the following steps to create such program:

1. Define the Data Area (DA) that reflects the structure of the flat file, including the data type and order of elements.
2. Write the batch extract program that retrieves each record that needs to be extracted and performs the following:
 - Populate the data area with the information to be extracted as appropriate.
 - Invoke the BusinessService “F1-ConvertXMLToFileFormat” to transform Data Area into the fixed length string. This string is written to the extract file when the program is executed.
 - Write the record to the extract flat file.
3. Create new batch control for the new extract program

Note: Refer to the **Appendix E** and the **Appendix F** for details regarding existing Batch Control and Sync Business Object (BO) Names respectively while trying to create the new extracts.

Note: For additional details, refer to the knowledge article “Extending the OUBI Data Warehouse (Using Sync BO in Oracle Utilities Meter Data Management) (Doc ID 1516859.1)” available at the My Oracle Support website (<https://support.oracle.com/>).

Oracle Utilities Network Management System

Oracle Utilities Network Management System (NMS) uses the view-based approach to detect the change in the source table that needs to be populated in the data warehouse.

To populate the new facts/dimensions, the following approach is to be followed:

1. Create new, modify and delete views that have the business logic to extract the required data.
2. Create a new extract program/procedure to access the view from above step.
3. Run the new extract program to retrieve data into flat files.

Note: Refer to the **Appendix G** for details regarding Extract Program and View Names while creating the extracts.

Creating a New Oracle Warehouse Builder Workflow

The ETL for the following source applications are based on Oracle Warehouse Builder and new load processes can be added based on the steps described in this section:

- Oracle Utilities Work and Asset Management
- Oracle Utilities Meter Data Management and Mobile Workforce Management
- Oracle Utilities Network Management System

Note: Before creating Oracle Warehouse Builder workflows, it is recommended that you should have knowledge of Oracle Warehouse Builder, Oracle Business Intelligence Enterprise Edition and Data Warehouse concepts. It is also recommended that you should have experience in developing Oracle Warehouse Builder components.

The steps below outline the high level steps to be carried out for creating the Oracle Warehouse Builder (OWB) ETL code:

1. Create a fact or dimension.
2. Specify the external table name.
3. Map a column from external table to target.
4. Specify the join conditions.
5. Generate the Oracle Warehouse Builder code.

Note: For specific details, refer to the **Appendix J: Oracle Warehouse Builder Deployment**.

Auto Cache Refresh

Oracle Business Intelligence Enterprise Edition (OBIEE) provides a mechanism called Event Polling, which allows Oracle Business Intelligence Enterprise Edition to query a database table to find out when data has been updated in fact or dimension tables. By modifying the Oracle Warehouse Builder load process to populate an Event Polling table, you can let Oracle Business Intelligence Enterprise Edition know when data has been updated in the data warehouse, and enable Oracle Business Intelligence Enterprise Edition to know when to refresh the cache data that has been queried before.

A new event polling table B1_OBIEE_EVENT_POLLING is available as a part of Oracle Utilities Analytics.

The use of an Oracle Business Intelligence Server Event Polling table (event table) is a way to notify Oracle Business Intelligence server that one or more physical tables have been updated, and then that the query cache entries are stale.

Each row that is added to an event table describes a single update event, such as an update occurring to a product table.

The Oracle Business Intelligence server cache system reads rows from, or polls, the event table, extracts the physical table information from the rows, and purges stale cache entries that reference those physical tables.

For new requirements, new extractors are created along with new Oracle Warehouse Builder load processes to load data into the new fact or dimension tables. Here in order to ensure that the Oracle Business Intelligence Enterprise Edition cache data is automatically refreshed, an additional step has to be included in the Oracle Warehouse Builder process flow to ensure that an entry is made in the available event polling table B1_OBIEE_EVENT_POLLING.

This will ensure that whenever new data is loaded by the Oracle Warehouse Builder process flow, the Oracle Business Intelligence Enterprise Edition cache is automatically refreshed and made available for the analytics reports.

Refer to an existing base product supplied Oracle Warehouse Builder process flow for samples.

Creating a New Object for Oracle Data Integrator Based ELT

The ELT for the following source applications are based on Oracle Data Integrator and new requirements can be added based on the steps described in this section.

- Oracle Utilities Customer Care and Billing (CC&B)
- Oracle Utilities Operational Device Management (ODM)

Note: Before creating new objects, it is recommended to be proficient with Oracle Data Integrator, Oracle Business Intelligence Enterprise Edition and Data Warehouse concepts. It is also recommended that you should have experience in developing Oracle Data Integrator components.

You can create the following:

1. All the custom interfaces, packages, or procedures in a separate folder under the main project folder.
2. All the custom models under a separate folder in the models section.

The following sections list out the activities that need to be performed to add new facts and dimensions using Oracle Data Integrator:

- **Configuring Entities**
- **Setting Up Replication**
- **Creating a New Model for the Facts**
- **Creating a New Model for the Dimensions**
- **Creating a New Model for the Replicated Objects**
- **Creating a New Interface**
- **Creating a New Package**
- **Creating a New Interface for the Materialized View**

Configuring Entities

Once you have designed the new facts and dimensions, perform the following steps to start your development.

1. Create the table structures in DWADM schema. The recommended practice is to prefix customer owned objects with CM_.

-
2. Use Oracle Utilities Analytics Administration to create entries in target entity and Job Configuration for the new objects that you have created.

Note: Refer to the **Appendix B** for further details.

Setting Up Replication

While developing the requirements for a new star schema objects, identify the source entities that will be required to populate the target entities. Using the **Admin** user interface, check if these entities are available in the table **B1_SOURCE_TABLES**. If yes, follow the steps mentioned in the **Extending Replication** section to enable replication for additional tables.

Assuming that the source system maintenance objects or specific tables that are sources for your new interfaces are not available in the table **B1_SOURCE_TABLES**, follow these steps:

1. In the current release, the metadata table **B1_OBJECT_MAP** is not exposed via the Admin user interface. You should not modify any entries already present in this table. For a new MO or the table source, you will need to create a new entry mapping your source MO/table to the target entity.
2. Once configured, execute the package **B1_OUAF_CFG_METATADA**. The **B1_OUAF_CFG_METATADA** package is an implementation accelerator for Oracle Utilities Application Framework products, and it pulls additional information for these objects into the metadata tables. This package is automatically executed during the addition of a new instance as a source for Oracle Utilities Business Intelligence.

Note: Refer to the **Appendix B** for a list of the metadata tables and the purpose of each of these metadata.

3. Follow the steps for extending replication to enable these new entities to be replicated.

Creating a New Model for the Facts

To create model for new facts, perform the following steps:

1. Create a new model for the facts.
2. Set the logical connection as “Target”.
3. Reverse engineer your newly created facts into this model.

Creating a New Model for the Dimensions

To create model for new dimensions, perform the following steps:

1. Create a new model for the dimensions.
2. Set the logical connection as “Target”.
3. Select the custom Reverse-engineering Knowledge Modules (RKM) for reverse engineering the dimensions. You can set the prefix used for the effective date columns in the type 2 dimensions.

The custom RKM auto configures type 1 and 2 dimension configurations based on the unique and primary keys on the database tables. The dimension should have a primary key constraint on the surrogate key column and a unique key on the natural key.

Creating a New Model for the Replicated Objects

Once the required objects have been replicated, follow the instructions below to set up a source model for the replicated tables.

1. Create a new model, set the logical schema to “Replication”.

2. Reverse engineer all objects you need as source for your target entities.

Creating a New Interface

To create a new interface for your target entities, follow the steps below:

1. Under your custom folder, right-click and select new interface.
2. Drag and drop your target table to the target section of the interface.
3. Drag and drop your source tables (from the replication model) into the source section of the interface.
4. Set up the appropriate join conditions between the tables.
5. Map the columns from the source to the target as per your design.
6. Add new filter.
 - Add the condition on slicing_ts column using the global variables, as below:

```
(src.slicing_ts >=
to_date('#B1_SLICE_BEG_TS', 'yyyymmddhh24miss')
( src.slicing_ts <
to_date('#B1_SLICE_END_TS', 'yyyymmddhh24miss'))
```
 - For multiple tables add an “OR” condition to ensure that all changed records are picked up even if the change occurred in only one table.
7. Mark the columns other than the Primary Key and Unique Key columns for update and all columns for insert.
8. In the **Flow** tab, select the appropriate Knowledge Module (KM) based on the target entity. The Knowledge Modules supplied with the product should be used and they have been named so that it is easy to identify the fact/dimension knowledge modules to be used.
9. Save the interface.

The following expression should be used for mapping the target dimension key columns:

```
(CASE WHEN SRC.<src_nk> IS NULL
      THEN #B1_DEF_NULL_KEY
      WHEN <dim>.<dim_pk> IS NULL
      THEN #B1_DEF_MISSING_KEY
      ELSE <dim>.<dim_pk>
      END)
```

In the sample code above, SRC is the alias of the primary source table that contains the source foreign key "<src_nk>" to the dimension. <dim> is the alias for the dimension and <dim_pk> is the primary key of the dimension.

Creating a New Package

A new package has to be created for each target entity. The easiest way to create a package for the entity is to copy an existing package based on the target object type and replace the interface with the new interface. While copying the package, remember to move it to the custom folder.

Below is a sample package for a type 2 dimension.

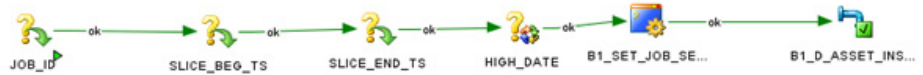

Below is a screenshot for a fact package.



Once the package has been created, right-click and generate the scenario. Ensure that the new package name has been configured appropriately in the **Job Configuration** section using the Admin user interface.

Creating a New Interface for the Materialized View

To create a new interface for your materialized views, perform the steps below:

1. Under the custom folder, right-click and select the new interface.
2. Drag and drop the source tables (facts and dimensions from target model) into the source section of the interface.
3. Set up the appropriate join conditions between the tables.
4. Map the columns from the source to the target as per your design.
5. A new package needs to be created for each materialized view interface. The package should contain the global variable **B1_JOB_ID**.

Creating a New Analytics

This section describes how to use Oracle Business Intelligence Enterprise Edition (OBIEE) to add new analytics. It includes the following topics:

- **Creating New Answers**
- **Adding New Labels**

Creating New Answers

Note: Before creating Oracle Warehouse Builder workflows, it is recommended that you should have knowledge of Oracle Business Intelligence Enterprise Edition and Data Warehouse concepts. It is also recommended that you should have experience in developing reports using Oracle Business Intelligence Enterprise Edition.

Oracle Utilities Analytics (OUA) provides out-of-the-box dashboards with rich and varied set of analytics for Credit and Collection Analytics, Customer Analytics, Distribution Analytics, Meter Data Analytics, Mobile Workforce Analytics, Outage Analytics, Revenue Analytics, Exception Analytics, and Work and Assets Analytics. However, if required, you can create new answers, or dashboards.

As noted in the above section regarding customization of existing answers, new answers should also be saved in a separate folder so that they are not overwritten while upgrading the Oracle Utilities Analytics.

A customer implementation can create field labels for use in their answers, or the labels can just be created directly in the answer if there are no multilingual/localization requirements. If product labels are used in an answer, they can be modified during an upgrade (unless you have entered an override label). At best, it is recommended to limit the changes to the existing labels; however, there can be certain situations, when they are updated.

Adding New Labels

If you want to use the label mechanism for new answers, then the **Custom Field Maintenance** dashboard can be used to add, update, and delete custom labels. These custom labels can then be used in answers as well as in the logical and physical objects in the repository or RPD file.

Note: Only custom field labels, identified by a **Customer Modification (CM)** owner flag, can be updated or deleted. The new labels are created with a **Customer Modification (CM)** owner flag. A label that already exists cannot be created, so if a base labels already exists, you can update the override label as described in the preceding section **Creating New Answers**.

Note: For more details, refer to the '**Administration Dashboards**' section in the **Chapter 4: Configuring Oracle Utilities Analytics**.

Chapter 7

Maintaining Environments

This section describes how to maintain your Oracle Utilities Analytics (OUA) environments, including moving code changes from one environment to another.

This section includes the following topics:

- **Overview of Environment Maintenance**
- **Moving Oracle Warehouse Builder Based Code**
- **Database Cloning for Oracle Warehouse Builder**
- **Oracle Data Integrator Based Products**

Overview of Environment Maintenance

You should implement processes to maintain code control over various environments. The following components of Oracle Utilities Analytics (OUA) should be handled separately.

- Oracle Business Intelligence Enterprise Edition web catalog
- Oracle Business Intelligence Enterprise Edition repository file
- Field Label metadata
- Oracle Warehouse Builder repository
- Oracle Utilities Application Framework (OUAF) metadata (only required if there are Oracle Warehouse Builder customizations)
- Mapviewer spatial data

Assuming that the custom changes are made to any of these objects, then a mechanism must be put in place to develop, test, and move these customizations to the production environment.

Moving Oracle Warehouse Builder Based Code

During the development phase of coding, you usually do not need to move code from a development environment to any other environments. However, once a project moves to the quality analyst or production phases, code changes may be needed to be migrated.

For example, in an internal development process, there may be two development environments: one for Oracle Business Intelligence Enterprise Edition (OBIEE) dashboard creation and one for Oracle Warehouse Builder (OWB) development. You can build a QA environment from the scratch: create an empty database, the Oracle Warehouse Builder objects will get imported and deployed, and the Oracle Business Intelligence Enterprise Edition web catalog and repository file will get created fresh.

To do this, use the installation process for creating an empty Oracle database, Oracle Warehouse Builder repository, and WebLogic environment. Then, use the Oracle Warehouse Builder Export process to create two MDL files from the development environment: one for the locations, and one for all of the other Oracle Warehouse Builder objects. You should then copy the Oracle Business Intelligence Enterprise Edition repository file, and use the Oracle Business Intelligence Enterprise Edition export process to create the Oracle Business Intelligence Enterprise Edition web catalog files.

Once you have these files, follow the install process to load the MDL files in the Oracle Warehouse Builder repository, copy the Oracle Business Intelligence Enterprise Edition repository file into the Quality Analysis (QA) WebLogic environment, update the user name, password, and database connections for the quality analysis databases, and import the web catalog export files into the same location as they were in the development environment.

This process works well for a development move to QA, but will not work once a system goes into production, because parts of this process require the creation of an empty database, which is not something that should be done in a production environment.

In situations, where bug fixes have been made in a development environment and they need to be moved to a production environment, you can export the entire Oracle Warehouse Builder repository and Oracle Business Intelligence Enterprise Edition web catalog and replace this in the production environment. Use this method to move the code if it is not known exactly which objects have changed.

For Oracle Warehouse Builder though, if the modified objects are known, then it is possible to export only the changed objects, import them in the QA environment, and then, once QA is successful, do the same import process into the production environment. Another option is to save the TCL files that were created by the Oracle Warehouse Builder Code Generator, and then load them into the QA and production environments.

Creating an MDL File

To create an MDL file for a known set of Oracle Warehouse Builder objects, follow these steps:

1. Log onto the Workflow Development Database using the Design Center as the Repository Owner (BIREPOWN).
2. Review the modified the Oracle Warehouse Builder (OWB) objects and then, select the Oracle Warehouse Builder objects.
3. Export them by navigating to **Design > WareHouse Builder Metadata**.
4. Review the path for MDL and log file, and select Export All Dependencies.
5. Click **Export**.
6. Use the created MDL file to move objects from a development environment to a QA, or production environment.

This process assumes that database changes are handled outside of Oracle Warehouse Builder. Hence, new tables, modifications to existing tables, or materialized view log changes should be handled via the SQL scripts created by the development team.

For Oracle Business Intelligence Enterprise Edition (OBIEE), a full move is not recommended; there are ways of merging code in the web catalog and also in the repository file. These methods are documented in *Oracle Business Intelligence Enterprise Edition Administration Guide*.

Note: Refer to the chapter 24, “**Moving Between Environments**,” in *System Administrator's Guide for Oracle Business Intelligence Enterprise Edition 11g Release 1*. This chapter shows how you can move Oracle Business Intelligence to a new environment, or from a test to a production environment.

For MapViewer data, modified override labels are added to the QA, or the production environments the same way that it is added to the development. If a shapelier is downloaded and

added to the development environment, the same shapelier should be added to the QA and the production environments.

Finally, it is very important that the process of moving code from the development to the QA is exactly the same as the process that moves the code to the production. It is only by following the same sequence of steps in both cases that the movement process is also tested. If one process is followed to move code to the QA and another process is followed to move code to the production, then problems can arise in the move to the production that were not seen in the move to the QA environment.

Database Cloning for Oracle Warehouse Builder

You can use database cloning to move the entire development database to a QA environment, or a new production environment. This cannot be used to move a development database to an existing production environment, as the existing production database tables will be overwritten. But for QA purposes, this can move the development database quicker than a fresh install.

Note: This does not move the Oracle Business Intelligence Enterprise Edition objects, but does handle all of the Oracle Warehouse Builder code, field label changes, marvin meditated, and any new database objects.

Cloning a Development Database

To clone a development database, follow these steps:

1. Clone the existing database.
2. Go to **\$ORACLE_HOME/owe/Underpays** directory.
3. Execute the **reset_owbcc_home.sql** with the OWBSYS user and **remote_owb_install.sql** scripts with the sys user.
4. Create the password file for database if it does not exist.
5. Go to **\$ORACLE_HOME/owe/repossess/up** directory and execute **upg112to11203.sql** as **scalpels /no-load @upg112to11203.sql** if database is cloned from lower Oracle Home version to Oracle 11.2.0.3 version home and this script is already not executed.
6. Wait till execution of this script. It will take time.
7. Connect as OWBSYS user and execute:
 - @\$ORACLE_HOME/owb/reposasst/secHelper.pks
 - @\$ORACLE_HOME/owb/reposasst/secHelper.plb
 - ORACLE_HOME/owb/reposasst/upg/load_java.sql OWBSYS
<OWBSYS_PASSWORD>
8. Navigate to **\$ORACLE_HOME/owb/bin/admin** and rename the **rtrepos.properties**.
9. Connect as **OWBSYS** user, and execute **@\$ORACLE_HOME/owb/rtp/sql/reset_repository.sql**.
10. Submit the **SELECT * FROM OWBRTPS** query.
It shows updated Oracle Home in the **Value** column.
11. Submit select **SERVER_SIDE_HOME** from **WB_RT_SERVICE_NODES** query.
It shows updated Oracle Home.
12. Log into to design repository and get name of all the Control Centers with which locations are registered.
13. Connect with **OWBSYS** and execute **UpdateControlCenter.sql** for all the Control Centers with which locations are registered. Provide the below inputs:

Enter Workspace Name: SPLBIREP
Enter Workspace User Name: BIREPOWN
Enter Control Center Name: <Control Center Name>
Host: <Hostname>
Port: 1521
Service Name: <DB name>
New Net Service Name: <DB name>

14. Run **@UpdateLocation.sql** for all locations. Make sure to provide the correct version.

For example:

Enter Workspace Name: SPLBIREP
Enter Workspace User Name: BIREPOWN
Enter Location Name: SPL_BI_TGT_LOC
New Host: <Hostname>
New Port: 1521
New Service Name: <DB name>
New Net Service Name: <DB name>
New Version: 11.2

Provide version 0 for SPL_BI_FF_LOC and SPL_BI_LOG_LOC locations and 2.6.4 for SPL_BI_WF_LOC location.

You can also use the below block to update the workflow location:

```
Declare
v_result boolean := FALSE;
Begin
v_result := wb_rt_reset_location.fixDTLocation
('SPL_BI_WF_LOC', '<Hostname>', '1521', '<DB name>', '2.6.4', '<WF
user>', '<WF user's password>');
END;
```

15. EXECUTE UPDATE WB_RT_SERVICE_NODES SET CONNECT_SPEC='<hostname>:1521:<DB name>'; commit;
16. Connect to the Control Center Manager in the Design repository.
17. Register all the locations.
18. Unregister all the locations.
19. Save all objects, and exit from the Control Center Manager.
20. Double-click the Control Center and move all selected locations to available locations. and click **OK**.
21. Rename the Control Center as required.
22. Set the other Control Center with which locations are registered as default Control Center for default_configuration and connect to the Control Center.
23. Register all the locations.
24. Unregister all locations. Save all objects, and exit from the Control Center
25. Double-click the Control Center, move all selected locations to available locations and click **OK**.

-
26. Rename the Control Center as required.
 27. Repeat steps from 22 to 26 for all registered Control Centers.

Doing so, you can remove all Control Center info from the **Registration** tab of all the locations.

If you are not removing Control Center dependency, you will be able to register location with any Control Center, but will not be able to update location info after you unregister the location.
 28. Move the locations from available section to selected location in the required Control Center, set the required Control Center as default Control Center for default_configuration and log into the Control Center.
 29. Now all locations are available for update and can be registered followed by objects deployment.

Oracle Data Integrator Based Products

This section includes:

- **Moving Oracle Data Integrator Repository**
- **Moving Metadata**
- **Purging**

Moving Oracle Data Integrator Repository

To move an Oracle Data Integrator repository, perform the following steps.

1. Log into the Oracle Data Integrator client using a supervisor user.
2. Export the master and work repository using the Oracle Data Integrator client.
3. Log out of the Oracle Data Integrator client.
4. Use the master repository creation wizard and create a new repository if it does not exist.
5. Log into the new master repository and import the XMLs exported earlier.
6. Modify the connections in the Topology section as required.
7. Delete/drop the older Oracle Data Integrator master and work repository schemas, or alternatively delete all connections, users from the **Topology and Security** sections respectively. This is a precautionary action to prevent any users from accidentally logging into the older repository and executing jobs.

Moving Metadata

The metadata objects reside in the DWADM schema by default. In case you have made some configuration changes and want to change to a different database, you will need to export the metadata objects and import them into the new environment.

Purging

A data warehouse is designed to accumulate data across many years. Over a period of time, the data is accumulated in the data warehouse. The data can consist of the following

- Star Schemas
- Logs (Audit/Process/Error)
- Replicated Data
- Staging Data

The target data warehouse data is usually expected to be retained for periods longer than seven years and even when the threshold is reached, the older data is expected to be archived. Since the archival routines and rules may differ for different implementors, archival of the target data warehouse is not covered here.

Depending on the policies in place it is always advisable to take a backup before purging data. A routine backup should be set up for the data warehouse.

This section provides details on what can be purged and how to purge. Not all topics are applicable in all the situations. The following sections are covered:

- **Oracle Utilities Network Management System /BI Recent Outage Data**
- **Near Real Time Data**
- **Oracle Warehouse Builder Audit Logs**
- **ETL Job Control Tables**
- **Oracle Data Integrator Session Logs**
- **Staging Data**
- **Replication Data**

Oracle Utilities Network Management System /BI Recent Outage Data

The Network Management System RDBMS is generally not intended to be in the long-term (longer than a year or two) repository for historical customer outage data. Rather Network Management System (NMS) is intended to track the current and relatively recent status of the utility load area infrastructure. The Network Management System RDBMS generally includes a record of relatively recent customer outages for operational reference/review purposes. Beyond this project specific “reasonably recent” window, it is expected that some type of Network Management System (NMS) outage data archive/purge process is executed on a regular (daily or weekly) basis to keep the Oracle Utilities Network Management System RDBMS instance relatively lean and performing optimally.

The Oracle Business Intelligence RDBMS is intended to be the long-term home for historical customer outage data. However, the Oracle Business Intelligence RDBMS tracks two different types of outages in two sets of Oracle Business Intelligence RDBMS tables and only one of them is considered a long-term repository. The Oracle Business Intelligence RDBMS tracks both recent and restored outages:

- **Recent outages:** It is also called as Near Real Time (NRT) outages. The primary purpose of the NRT data store is to support tracking current (active) and relatively recent completed outages. The NRT data store can also be used to help gauge the ability of existing resources to deal with a current storm to help determine if external/foreign (crew) resources will or will not be required. Just like the Oracle Utilities Network Management System RDBMS data store, the Oracle Business Intelligence RDBMS “recent outage” data store is not intended to be a long-term repository.
- **Restored outages:** It is also called as historical outage data. The primary purpose of the restored outage tables is for the long-term reporting purposes. The restored outage data store

should be the most accurate data store and is intended to support the required regulatory customer impact reports. This data store has no periodic purge requirements. The historical outage data is intended to be held in this data store indefinitely.

Near Real Time Data

The Near Real Time (NRT) data can be purged two ways:

- Purging data manually using Oracle supplied SQL script.
- Purging Oracle Business Intelligence NRT data through the extract files generated on Oracle Utilities Network Management System side based on the contents of the **oms_delete_log** table.

In both methods described above, the database function `SPL_OMS_SNAPSHOT_PKG.SPL_PURGE_RECENT_FNC` is being executed to purge the data. The database function physically deletes the data from the following tables:

- `cf_recent_call`
- `cf_recent_crew`
- `cf_recent_job`
- `cf_cust_recent_outg`
- `cf_recent_td_entry`

When data is purged manually through Oracle supplied script, the function deletes data older than a customer defined retention period. When NRT data is being purged using extract files generated on Oracle Utilities Network Management System side, the Oracle Business Intelligence import job reads the Oracle Utilities Network Management System extract file and executes the workflow package **SPLWF_F_PURGE_RECENT**. The workflow package calls the same database function (`SPL_OMS_SNAPSHOT_PKG.SPL_PURGE_RECENT_FNC`) to physically purge the no longer desired Oracle Business Intelligence NRT data.

The following things are to be noted while purging Oracle Business Intelligence data:

- Purging Oracle Business Intelligence data using either of the above method requires no down time. Purging jobs can be scheduled while other BI import jobs are running.
- If the data to be deleted does not exist in Oracle Business Intelligence RDBMS, no SQL error will be generated since the DELETE statements will find nothing to delete.
- Purging Oracle Business Intelligence NRT data can be done independent of Oracle Utilities Network Management System data purging process. The retention period of data for Oracle Utilities Network Management System and Oracle Business Intelligence can be different. The retention period can be defined based on customer's business needs.
- It is worth noting that having smaller data volume in Oracle Business Intelligence NRT tables improves performance for import jobs and building materialized views that are based on NRT tables.
- It is generally advised that periodic purge of Oracle Business Intelligence NRT data should be done on a regular basis - at least weekly, or possibly daily. This is can be achieved via an automated process (Cron or similar).

Oracle Warehouse Builder Audit Logs

Note: This is applicable to the Oracle Warehouse Builder based ETL only.

Oracle Utilities Analytics (OUA) utilizes Oracle Workflow when running Oracle Warehouse Builder (OWB) process flows to load extract files into the data warehouse. Even if the extract files are not present, the records are created in the audit tables each time a process flow is run. Depending on the frequency with which process flows are scheduled, these audit tables can grow to become unmanageable and can cause upgrades or process flow changes to fail when deployed.

The following topics are discussed in this section:

- Purging Extract, Transform, and Load (ETL) Job Control tables
- Configuring Oracle Warehouse Builder to enable purging

A few of these audit tables include the run-time Oracle workflow audit tables and can grow very large:

- **WF_ITEM_ATTRIBUTE_VALUES**: This table stores the run-time values of the item attributes for a particular process flow.
- **WF_ITEM_ACTIVITY_STATUSES**: This table, along with the **WF_ITEM_ACTIVITY_STATUSES_H** contains all of the activities executed by a specific occurrence of a process flow.
- **WF_NOTIFICATION_ATTRIBUTES**: This table contains the run-time values of all the message attributes for a specific notification.
- In addition, Oracle Warehouse Builder (OWB) also contains audit tables that can also grow very large if not purged periodically.

Oracle Utilities Analytics includes a purge process flow that calls Oracle Warehouse Builder and Oracle Workflow Application Programming Interfaces (APIs) to purge these audit tables as well. The **OUBIWF_PURGE_RT_AUDIT** process flow in the **INIT_PKG** package is set up to purge audit data that is older than one month.

The **OUBIWF_PURGE_RT_AUDIT** process flow is not run from the File Processor daemon, so you must schedule it using a scheduler tool that can run Oracle Warehouse Builder process flows. You can also schedule the procedure that this process flow calls, **OUBI_PURGE_RT_AUDIT_DATA_PRC** using a tool that can call a PL/SQL command. This procedure requires no parameters, and can be called directly from a PL/SQL block, like this:

```
BEGIN
  OUBI_PURGE_RT_AUDIT_DATA_PRC;
END;
```

You should run either this purge routine, or the Oracle Warehouse Builder and OWF purge routines at least monthly, so that the audit tables remain small. It is recommended to purge these tables at least once a month.

ETL Job Control Tables

Note: This is applicable to the Oracle Warehouse Builder based ETL only.

It is recommended that the Extract, Transform, and Load Job Control tables be purged on a regular basis. For analysis purposes, it is suggested to retain 30-90 days of data, but depending on your need this value should be appropriately adjusted.

The ETL Job Control table resides in the **dwadm** schema on the Oracle Business Intelligence instance. A sample script to purge the ETL Job Control table is shown below. Provide an appropriate value for the number of days for which the data needs to be retained in the ETL Job Control table.

```
delete from bl_etl_job_ctrl
where start_dttm < sysdate -&days_to_retain and end_dttm is not
null
and job_status_flag = 'JC';
commit;
```

Oracle Data Integrator Session Logs

Note: This is applicable to Oracle Data Integrator ELT only.

Oracle Data Integrator session logs that are older than a calculated date are purged periodically. The date is calculated as below:

purge date = Least of (current date - b1_retain_days, the oldest session start where job is in error and has not been reprocessed)

The Oracle Data Integrator global variable b1_retain_days is set to 1 by default. It can be configured using Oracle Data Integrator client to a different value.

Staging Data

Note: This is applicable to Oracle Data Integrator ELT only.

There is one staging table for each target entity. The staging data is useful for tracing the data propagation and debugging in case of issues. The retention period is configured in the metadata table **B1_TARGET_ENTITY** using the column **STG_RETAIN_DAYS**. The default value is 7.

The staging data older than configured retention period is automatically purged as a part of the execution of the interface.

Replication Data

Note: This is applicable to Oracle Data Integrator ELT only.

Each source table that has been marked for replication has a replica table created in the replication schema. The tables that are used as source for type 2 dimensions retain history for each change. Over a period of time the volume in the replication area can grow huge. It is recommended to retain the data in the replication layer for as long as it is feasible to do so considering the data storage requirements as this will enable you to reload the warehouse at any given point of time. This comes in handy when additional user-defined columns are being added and you want to reload all entities where the new user-defined column has been configured for load.

The table **B1_SOURCE_TABLE** has a column **REPL_RETAIN_DAYS**, which can be modified to control the purge in replication area.

Note:

A minimum retention period of 30 days is enforced.

If there are multiple target entities dependent on the source table, then the least of the last sync timestamp of the entities is considered.

If the least of last_sync_dttm is older than the retention period, then the data older than this data is purged

Chapter 8

Licensing and Optional Features

This chapter describes about licensing and optional features, including:

- **Oracle Database Licensing and Optional Features**
- **Oracle Warehouse Builder Licensing and Optional Features**
- **Disabling the Optional Features in Oracle Warehouse Builder**
- **Oracle GoldenGate Licensing**

Oracle Database Licensing and Optional Features

With Oracle Utilities Analytics release 2.5.0.0.1, the **Standard Edition** of Oracle database is now supported. Currently, this support is only for the customers using those Extractors and Schema products, which are based on Oracle Data Integrator (ODI) based extraction, and includes:

- Oracle Utilities Operational Device Management Extractors and Schema
- Oracle Utilities Customer Care and Billing Extractors and Schema

However, Oracle recommends to use the **Enterprise Edition** of Oracle database for performance and scalability reasons, as the Oracle Utilities Analytics data warehouse is expected to handle large volumes of data. Oracle Utilities Analytics also supports the *Oracle Partitioning* feature, which is an extra cost option on the top of the Oracle Database Enterprise Edition. Using this feature, it is also recommended for the efficient data storage and retrieval by the Oracle Utilities Analytics product.

By default, the **Enterprise Edition** and the **Partitioning** features are turned off in the Oracle Utilities Analytics product. Once the appropriate licenses have been purchased, these features can be turned on in the **Global Configuration** settings using the Oracle Utilities Analytics Administration tool described in **Appendix B**.

Oracle Warehouse Builder Licensing and Optional Features

Oracle Warehouse Builder (OWB) provides various optional features, which are not included in the basic Extraction, Transformation, and Loading (ETL) feature group. The basic ETL feature group is included in the Oracle Database Enterprise Edition license. Hence, there is no additional license cost required to use, or install the basic features. The standard ETL processes included in Oracle Utilities Analytics (OUA) uses only the features that are included in the basic ETL feature group.

In addition, the Oracle Warehouse Builder Code Generator does not create any code that requires the use of optional Oracle Warehouse Builder features. Hence, any additional Extraction, Transformation, and Loading (ETL) code created by an implementation using the Oracle Warehouse Builder Code Generator does not require any additional Oracle Warehouse Builder

license costs. However, if Oracle Warehouse Builder is used to create other ETL code outside of the Oracle Warehouse Builder Code Generator, then using some of these optional features may require additional Oracle Warehouse Builder licenses.

Disabling the Optional Features in Oracle Warehouse Builder

In order to ensure that optional features are not used, Oracle Warehouse Builder (OWB) provides a means to disable the use of optional features. After starting the Warehouse Builder Repository Assistant, choose the “**Manage optional features**” operation, as shown in the following image.

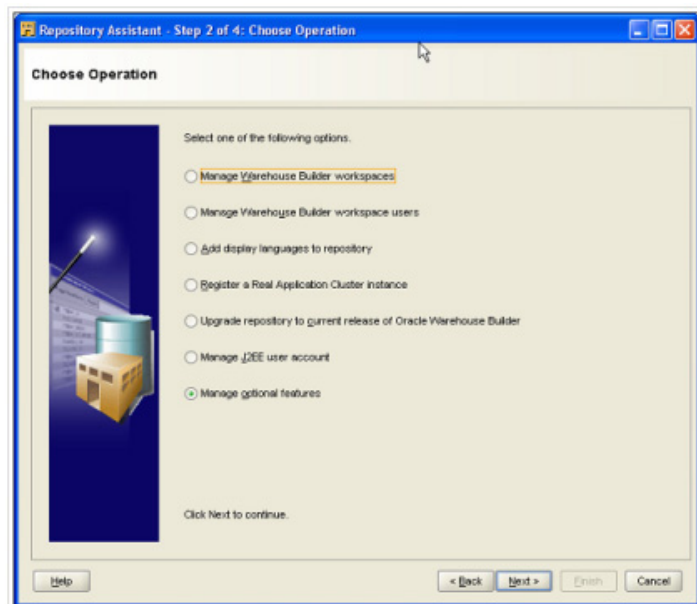

After entering the password for the OWBSYS user, deselect all of the licensed option names on the **Enable Optional Features** page.

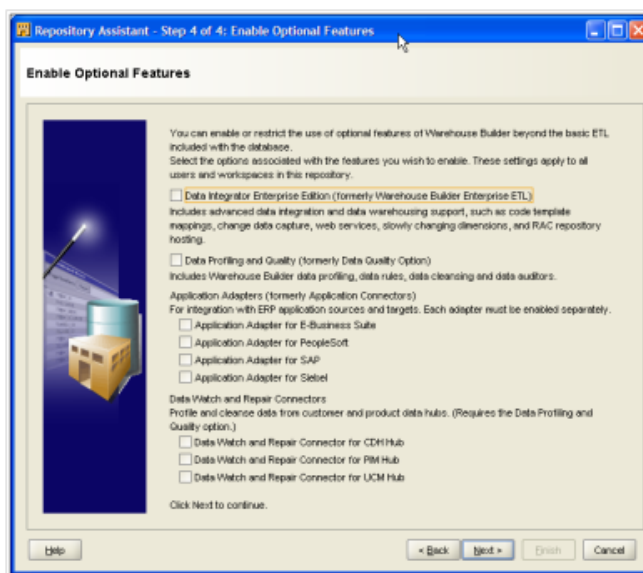

Once the options are deselected, the new selections will take effect for any new connections to Oracle Warehouse Builder, and if options are used that are not available, an error dialog is displayed.

Note: For further details regarding the feature groups and licensing of Oracle Warehouse Builder, visit the Oracle Warehouse Builder page on the Oracle Technology Network (OTN) at this location:

<http://www.oracle.com/technetwork/developer-tools/warehouse>.

Oracle GoldenGate Licensing

The GoldenGate license purchased along with Oracle Utilities Analytics v2.5.0.0.1, can be used to replicate additional tables from the any of the source systems products whose ETL processes are based on Oracle Data Integrator (ODI), which includes:

- Oracle Utilities Operational Device Management
- Oracle Utilities Customer Care and Billing

For any other usage of the Oracle Golden Gate product, you need to purchase a full license of the Oracle GoldenGate product. Please contact Oracle Support for the details.

Appendix A

Oracle Utilities Application Framework Extractors

This section contains the following topics and describes the general structure and process followed for the extractors for Oracle Utilities Application Framework based applications, such as Oracle Utilities Work and Asset Management:

- **Change Detect Mechanism**
- **Fields on the Change Log**
- **Structure of Triggers**
- **Rows in the Change Log**
- **Extracting and Transforming Data**
- **Modes of Execution**
- **Basic Parameters Supplied To Extract Processes**

Note: This section applies to Oracle Utilities Work and Asset Management.

Change Detect Mechanism

Every production database table used to populate the data warehouse must be monitored for changes so that these changes can be reflected in the data warehouse. The triggers insert a row into the change log when the source tables change.

Fields on the Change Log

The sole job of the triggers is to populate the change log. Therefore, you must understand the fields of the change log table in order to understand the triggers. The change log contains the following primary fields

Field	Purpose
Change Log ID	This is a random prime key of the change log, and is generated by the trigger.
Batch Code	This is the code for the extract process that processes this change.
Batch Number	This is the current run number for the extract process.
Change Date and Time	The date and time of the change.

Field	Purpose
Change Type	This indicates if a row in the table was inserted, updated, or deleted.
Table Name	The name of the table that is changed.
Prime Key 1 - 5	The prime key of the object that is affected. The change log accommodates prime keys with up to five parts. The prime key stored on the change log is not the prime key of the record that is changed, but the prime key of the object. For example, if the phone number of a person is changed, these prime key fields would contain the prime key of the person object, not the prime key of the phone number record. When any field on an object is changed, the entire object is re-extracted.

Structure of Triggers

All the triggers populate the change log, and they are similar in the following ways:

- Determine if a row needs to be inserted into the change log. All table changes do not need to be reflected in the data warehouse, so not all changes need to be noted in the change log. For example, if an unfrozen financial transaction is created, a change log record does not need to be inserted if the data warehouse only tracks frozen financial transactions.
- Generate a prime key for the change log.
- Know the codes for the appropriate extract processes that handle the table change.
- Retrieve the current run numbers for the extract processes.
- Determine the prime key of the main object.

Rows in the Change Log

A record in the change log is processed by only one extract process. If multiple extract processes are needed to handle a single change in a source table (for example, if a new object requires the addition of multiple facts or dimensions), then multiple rows are inserted into the change log. This can be accomplished with one trigger inserting multiple rows into the change log, or with multiple triggers on the same table, each trigger inserting one row.

Extracting and Transforming Data

Oracle Utilities Work and Asset Management use batch controls with an underlying extract program to generate the flat files based on the change log tables populated by the triggers.

Modes of Execution

Most extract programs support two modes of execution (you can control the mode by a parameter supplied to the extract process):

- **Extract Everything Mode, or Initial Extract:** This mode extracts every row on the operational table. You can use this mode to instantiate the data warehouse. For example, if you run the extract accounts program in “extract everything mode”, every account will be extracted.
- **Extract Recent Changes Mode, or Incremental Extract:** This mode only extracts data that is added or changed since the last time the extract was executed. For example, if you run

the extract accounts program in “extract recent changes mode”, every account that is added or changed since the last execution will be extracted.

Basic Parameters Supplied To Extract Processes

All extract processes are submitted in their source system (For example, programs that extract data from Oracle Utilities Work and Asset Management are submitted in Oracle Utilities Work and Asset Management). The following points describe the parameters that are supplied to these processes for Oracle Utilities Work and Asset Management:

- **Batch Code:** The batch code is the unique identifier of the extract process. The batch code for each extract process is identified in the description of the various facts and dimensions.

Note: Refer to the appropriate fact and dimension chapter for the details in the *Oracle Utilities Data Mapping Guides*.

- **Batch Thread Number:** The thread number is only used for extract processes that can be run in multiple parallel threads. It contains the relative thread number of the process. For example, if the arrears process has been set up to run in 20 parallel threads, each of the 20 instances receives its relative thread number (1 through 20).

Note: Refer to the section **Optimal Thread Count for Parallel Background Processes** in the **Background Process** chapter of the source system’s data mapping guide for more information.

- **Batch Thread Count:** Thread count is only used for extract processes that can be run in multiple parallel threads. It contains the total number of parallel threads that have been scheduled. For example, if the billing process has been set up to run in 20 parallel threads, each of the 20 instances receives a thread count of 20.

Note: Refer to the section **Optimal Thread Count for Parallel Background Processes** in the **Background Process** chapter of the source system’s data mapping guide for more information.

- **Batch Rerun Number:** Rerun number should only be supplied if you need to download an historical run (rather than the latest run).
- **Batch Business Date:** Business date is only used for the extract processes that use the current date in their processing. For example, the Oracle Utilities Customer Care and Billing arrears extracts use the business date to extract arrears as of a given date. If this parameter is left blank, the system date is used. If supplied, this date must be in the format YYYY-MM-DD. This parameter is only used to test how processes behave over time.

- **Override Maximum Minutes Between Cursor Re-initiation:** This parameter is optional and overrides each extract process's standard cursor re-initiation minutes. Each extract process re-initiates cursors every 15 minutes. You can reduce these values. For example, if you are submitting a job during the day and you want more frequent commits to release held resources (or more frequent cursor initiations). You may want to increase these values when an extract process is executed at night or on weekends, and you have sufficient bandwidth and memory available on the servers. The maximum minute between cursor re-initiation parameter is relevant for Oracle implementations only. Most of the system extract processes contain an outermost loop/cursor. The cursor is opened at the beginning of the process and closed at the end. If Oracle detects that the cursor is open for too long, it may incorrectly interpret this as a problem and will display an error that the snapshot is too old. The processing for the extract processes is designed to refresh the cursor based on the minutes between cursor re-initiation in order to prevent this error.

- **User ID:** The following must be ensured with respect to a user ID:

- **User ID:** The **User ID** is a user who has access to all application services in the system as some batch processes call application services to perform maintenance functions (for example, when an account is updated, the batch process may call the account

maintenance application service). The display profile of the user ID controls how dates and currency values are formatted in messages.

- **Password:** Currently, the password is not used.
- **Language Code:** All language-sensitive data is extracted in this language. In addition, all error messages are presented in this language.
- **Trace program at Start (Y/N), Trace Program Exit (Y/N), Trace SQL (Y/N) and Output Trace (Y/N):** These switches are only used during Quality Analysis (QA) testing and benchmarking. If the trace program start is set to **Y**, a message is displayed whenever a program is started. If the trace program at exist is set to **Y**, a message is displayed whenever a program is exited. If the trace SQL is set to **Y**, a message is displayed whenever an SQL statement is executed. If the output trace is set to **Y**, special messages formatted by the extract process are written.

The information displayed when the output trace switch is turned on depends on each extract process. It is possible that an extract process displays no special information for this switch.

- **Initial Load Switch:** This switch controls whether the extract program is run in extract everything mode or extract recent changes mode.
- **File Path and File Name:** These parameters define the file path and/or file name for the output file. When supplying a file-path variable, the directory specified in the file-path must already exist and must grant write access to the Oracle Utilities Business Intelligence administrator account. You may need to verify a proper location with your system administrator. The syntax of the file-path depends on the platform used for Oracle Utilities Business Intelligence application server. Contact your system administrator for verification. For example, if the platform is UNIX, use forward slashes and be sure to put a trailing slash, such as `/spltemp/filepath/`.

Note: The control file is created with the same name as the data file, but with a fixed extension of CTL. For this reason, do not use CTL as the extension when defining value for the file-path parameter.

In order to avoid overwriting the flat files generated during the previous execution, the extractor programs insert a string containing the concatenated values of data source indicator, batch number, and the batch thread number in the name of the generated data and the control file. The value is inserted just before the extension of the file name specified.

- **Maximum Errors:** This parameter is not currently used.
- **User-Defined File UDF and UDMs:** Refer to extending extractors for the details on how to extend the various UDF and UDM fields.

Appendix B

Oracle Utilities Analytics Administration

The Oracle Data Integrator based Extract, Load and Transform (ELT) architecture is a metadata driven framework that allows you to configure the out of the box ELT jobs, as well as making it easy to integrate custom ELT jobs to Oracle Utilities Analytics product. The out-of-the-box ELT jobs are set up during the installation of the product. However, you can alter or maintain some of the parameters using Oracle Utilities Analytics Administration tool.

Note: Refer to the **Chapter 9: Installing the Oracle Utilities Analytics Admin Tool** in *Oracle Utilities Analytics for Oracle Utilities Extractors and Schema and Oracle Utilities Analytics Dashboards Installation Guide* for details on how to install and access the Administration tool.

This section contains the following topics:

- **Metadata Tables**
- **Product Instance**
- **Target Entity**
- **Job Configuration**
- **Source Table**
- **Job Executions**
- **Oracle GoldenGate Configuration**
- **Global Configuration**

Metadata Tables

The following table lists the metadata tables used to store this metadata, and the purpose of each.

Entity	Purpose
Product	This table is used to identify, which products are supported, and to identify the Oracle Data Integrator scenario (accelerator) to be used to import source metadata and configurations. This table is for the internal use.

Entity	Purpose
Product Instance	<p>You may have multiple instances of the same product that you want to integrate with Oracle Utilities Business Intelligence solution. The instance object represents each instance of the same product that can be utilized as a source. The objective is to enable development of a single interface that can be utilized across multiple instances.</p> <p>Instances differ by the source database connections and possibly by the differing configurations. The data source indicator is unique across instances and products as this allows traceability to identify the source of the data in the data warehouse.</p>
Target Entity	<p>This table holds the configurations for target entities in the data warehouse. The target entities can be dimensions, facts, or materialized views. The same target entity may be loaded from multiple source instances. The configuration that is common across multiple instances is stored in this table.</p>
Job Configuration	<p>This table is used to provide configuration for the package (the executable logic) for populating the target entities for each instance. This table stores the current progress and an override package for use when the logic for one instance differs from the logic used for the other instances.</p>
Object Map	<p>The table contains mapping between the various source MOs, or the BOs to the target entity that they will be used to populate.</p>
Source Tables	<p>This table contains configurations controlling, such as tables to be replicated and the mode of replication.</p>
Job Executions	<p>This table is used for tracking the execution of the ELT processes. An entry is created for each execution. Some attributes are populated from the SNP_SESSION table, which are used by Oracle Data Integrator to track sessions.</p>

Entity	Purpose
Dependencies	<p>This table is used to map a job to the dependent jobs. The dependent objects are only to be executed up to the minimum sync timestamp of all the dependencies. For example:</p> <ul style="list-style-type: none"> • The Operational Device fact is associated with three type 2 dimensions (Operational Device, Utilities Asset, and Address). • Assuming that the Operational Device fact is scheduled to run at 11 AM, and the Address dimension is scheduled to run at 7 AM. • The Address dimension would have processed all changes to address till 7AM. Assume an address location exists for a warehouse location in NY with ID101, the effective start date of 01/10/2010 and the effective end date of 31/12/4000. • A device was added to the system at 9 AM and a change is made to the NY location 101. • At 11 AM when the fact is processed, since the Address dimension is loaded only till 7 AM, the new history starting 7/30/2013 09:00 AM is not yet in the dimension and this will end up referencing the older record. • To avoid this, the fact will be loaded only up to the last load timestamp of the Address dimension, which in this example will be 7 AM.
DSI Mapping	<p>A source system may be integrated with other source systems. When pulling information from multiple source instances it is possible that the data in one instance refers to master data from another instance. This table allows such cross references to be configurable. By default, the configuration is at an instance level that is a product and instance number level. However, more fine grained control is possible by specifying the entity for which the configuration should be applied.</p> <p>Note: You will have to configure data for this entity on the source application. For details, refer to the 'Configuration' chapter in the <i>Oracle Utilities Analytics Data Mapping Guides</i> of the respective source application.</p>
Oracle GoldenGate Configuration	<p>This table is used to provide configuration details to be utilized for the Oracle GoldenGate script deployment on the source and target environments. An entry needs to be created for each source instance providing details, such as host, port, SID, Oracle home path etc.</p>
Oracle GoldenGate Checkpoint	<p>This table is used by Oracle GoldenGate replication process to track its processing activities. This table is used by the scheduler process to ensure that the warehouse loading tasks only process data that has been synced. The structure is controlled by Oracle GoldenGate.</p>

Entity	Purpose
Extract/Job Parameters	<p>This table stores configurations that control the extraction of data. Each source system may have different codes used for the different purposes. This table allows you to configure the codes so that the extraction routine can utilize it appropriately.</p> <p>Note: You will have to configure data for this entity on the source application. For details, refer to the 'Configuration' chapter in the <i>Oracle Utilities Analytics Data Mapping Guides</i> of the respective source application.</p>
Global Configuration	<p>This table stores the global settings that are required for the Oracle Utilities Analytics product. The examples of these configuration settings are the database edition type owner by the customer, cut-off time to be used by ETL jobs, global extract date for the initial load, etc.</p>

Many of the metadata tables mentioned above can be configured / maintained with the help of the Administration tool. The Administration tool is delivered along with Oracle Utilities Analytics (OUA) product to allow you to maintain these tables. This Administration tool has been built on the top of the **Oracle Application Express** feature, which is available with the Oracle database. The following sections explain the details of the metadata tables that you can maintain using the **Administration** tool.

Product Instance

The Product Instance represents a specific instance of a source application that can be configured as a source for Oracle Utilities Business Intelligence solution. A record is created for every instance of the product for which ETL is setup to extract data. Oracle Utilities Analytics delivers a record for the product which uses Oracle Data Integrator for the ETL. You may have multiple instances of the same source application that you want to integrate with the Oracle Utilities Analytics data warehouse.

The following attributes are available on the Product Instance metadata table.

Attribute	Purpose
Product Code	A reference to the product code, identifying the product for this instance.
Instance Number	A unique number starting with 1 to uniquely identify the instance.
Context Code	A unique code comprised of the product code and instance number which is used to identify the connections in Oracle Data Integrator. Due to limitations imposed by Oracle GoldenGate (used for replication), the context code cannot be more than 5 characters in length.
Data Source Indicator	A unique value representing the instance. For Oracle Utilities Application Framework products, this is the environment ID of the source instance.
Journal Indicator	A flag identifying the methodology to be used for replicating source tables. The default is Oracle GoldenGate.

Attribute	Purpose
Drill back URL	A URL to be used to allow you to drill back to the source system from the analytics.
Currency code	The currency used in the source product instance. Multiple currencies are not supported.
Time Zone Code	The time zone of the source product instance. This allows the interfaces to be built so that dependencies on job execution for multiple time zones are handled correctly.
Language Code	The primary language supported by the data warehouse. This is used to filter language specific data in the data warehouse.
Source Instance Version	The current version number of the source product instance. This can be used to validate whether the version is supported by the data warehouse, or provide suggestions in case upgrades, or patches need to be applied to enable support for the source product.

The **Product Instance** page in the Administration tool allows you to maintain existing records. To add a new product instance, you will have to use the script delivered as part of the installation package.

For more details, refer to *Oracle Utilities Analytics for Oracle Utilities Extractors and Schema and Oracle Utilities Analytics Dashboards Installation Guide* and check the **Configure Source** sub-section under **Post Installation Tasks of Oracle Data Integrator ELT Installation** section in the chapter 5.

Maintain Product Instance

Main
Cancel Delete Save

Source Product * Oracle Operational Device Management

Instance Number * 1

Context Code ODM1

Change Data Capture * Oracle Golden Gate

Drillback URL *
Note : Enter the URL to access the source application in the following format http://(host-name):(port)/ouaf/cis.jsp

Information Retrieved from Source

Time Zone Offset
Note : Specify in the following format 'HH24:MI:SS'

Currency

Language

Data Source Indicator 273498

Product Version V2.0.1.1.0

Target Entity

This table holds the configurations for target entities and their attributes in the data warehouse. The target entities can be dimensions, or facts. The same target entity may be loaded from multiple source instances. Configuration that is common across multiple instances is stored in this table.

Attribute	Purpose
Name	The name of the entity, which needs to be scheduled for loading into the target.
Type	The type of the entity supported by Oracle Utilities Analytics: <ul style="list-style-type: none">• Slowly changing dimension type 1• Slowly changing dimension type 2• Accumulation facts• Snapshot facts• Materialized views
Maximum Parallel Executions	To efficiently load data, it may be necessary to execute multiple instances, each instance working on a different data set. This attribute controls how many parallel executions can be spawned for a single entity load.
Retry Interval	The base architecture has been designed for automatic retries. In case of failures, jobs are retried and this attribute controls the interval between successive retries in case of a failure. Default is 30 minutes, but can be configured as per the requirement.
Maximum Retries per day	This attribute controls the maximum number of retry attempts in a day. Once this limit is reached and the load is still failing, it is retried next day.
Schedule Type	Three different modes of schedules are supported: <ul style="list-style-type: none">• Daily Incremental Load: Loads are executed as soon as data is available for load.• Near Real time Load: Loads are executed within a configured interval. This is for future use.• One time Load: A load is executed only once.
Schedule Interval	This is applicable for NRT loads only and the value controls the frequency of execution of the load process.
Schedule Time	A job is executed only after the scheduled time each day. The default is 00:00. This can be changed as per the requirement.

Attribute	Purpose
Slice Duration Type	<p>In any data warehouse, the basic challenge is to get the data loaded quickly and efficiently whether it is the initial load or the incremental load. Data volumes are high during initial load and during incremental loads, the volumes are considerably smaller. A slice is a volume of data bound within duration of time. Different objects have differing data distribution and load processing requirements. This attribute controls the duration between two slices. The following slicing intervals are supported:</p> <ul style="list-style-type: none"> • Day(s) • Week(s) • Month(s) • Quarter(s) • Year(s) • Hour(s) • Minute(s)
Slice Duration	The number identifying the slice duration based on the slice duration type.
Package	The name of the Oracle Data Integrator scenario that should be executed. Refer to the Appendix L for a list of packages pre-configured for Oracle Data Integrator.
Staging Retention Period	The number of days to retain data in the staging tables.
Owner Flag	Indicates whether the record is owned by the base product (B1) or the customer (CM).

The **Target Entity** page in the Administration tool allows you to add, edit, and delete records. Records are delivered out of the box for the star schemas tables delivered with Oracle Utilities Analytics product. For these records, you can edit only select fields. You cannot delete base product owned records. Create new records for any entity that you want to add to the ELT. For owned records, you have full access to edit and delete them.

Job Configuration

The **Job Configuration** page in the Administration tool allows you to add, edit and delete records. As a part of the Oracle Utilities Analytics installation process, job configuration records are generated for the target entities available out of the box. You can then use this page to change the configurations.

The screenshot shows the 'Maintain Job Configuration' window. It is divided into three main sections: 'Main', 'Scheduling Parameters', and 'Customization Attributes'. The 'Main' section includes fields for Job Configuration Id (14), Source Product (Oracle Operational Device Management), Instance Number (1), and Target Entity (14). The 'Scheduling Parameters' section includes Entity Active Flag (Yes), Slice Start Date/Time (24-APR-2013 18:51:17), Initialize Flag (Yes), Execution Sequence, and Last Sync Date/Time (24-APR-13). The 'Customization Attributes' section includes Override ODI Package Name and User Exit Procedure.

Enable Jobs Page

The **Enable Jobs** page can be accessed by clicking the button present on the **Job Configuration Report** page.



This page allows the end user to mass enable jobs by turning on the 'Entity Active Flag' for all those jobs that match the specified input criteria.

The screenshot shows the 'Enable Jobs for a Product Instance' form. It has a title bar and two dropdown menus: 'Source Product' and 'Instance Number'.

Source Table

This table contains configurations controlling, such as the source tables to be replicated and the mode of replication.

Attribute	Purpose
Product Code	A reference to the product code, identifying the product for this instance.
Name	The name of the source table. There is a corresponding entry in the objects table also.
Mode	The following scenarios exist: <ul style="list-style-type: none"> Source system tracks history using an effective date column No history in source but needs history for the type 2 dimensions No history required
Effective Date Column	The column name used for storing the effective dates in the source.
Base Replication	Controls whether the table is required to be replicated for target entity load.
Customize Replication	Extension for customizations. The additional tables to be marked for replication.
Purge Enabled	Controls whether the replicated table should be purged or not.
Retention Period	The number of days the data should be retained in the replication layer.
Owner Flag	Indicates whether the record is owned by the base product (B1) or the customer (CM).

The **Source Table** page in the Administration tool allows you to add, edit, and delete records. For this table, records are delivered out of the box for the source tables that are configured to be part of the out-of-the-box ELT. For these records, you can edit only selected fields. You cannot delete base product owned records. However, for owned records, you have full access to edit and delete them.

Job Executions

This table is used for tracking the execution of the ELT processes. An entry is created for each job execution.

Attribute	Purpose
Job Configuration	A reference to the job configuration.
Session Number	Reference to the Oracle Data Integrator session number.
Scheduled Start Time	The start time as set in the schedule.
Slice Start	The starting timestamp of the slice.
Slice End	The ending timestamp of the slice.

Attribute	Purpose
Status	A composite status for the job. Primarily, the status is derived from SNP_SESSION. However, additional statuses are tracked in job executions: <ul style="list-style-type: none"> • Pending • Submitted • Running • Reprocessed • Error • Done
Actual Start time	The timestamp when the job actually started.
Actual End time	The timestamp when the job actually ended.
Duration	The total execution time in seconds.
Insert Count	The number of records inserted.
Update Count	The number of records updated.
Delete Count	The number of deletions.
Error Count	The number of rows identified as error.
Total Count	The number of rows processed. sum of the above.

Use the **Job Execution** page on the **Administration** tool to monitor execution of the jobs. You cannot edit or create records in this table.

Job Execution Details

Main
Back

Job Execution Id	161
Job Configuration Id	7
Status	Done
Scheduled Start Date/Time	24-APR-2013 00:00:00

Execution Details

Session	563602
Slice Start Date/Time	24-APR-2013 18:48:46
Slice End Date/Time	24-APR-2013 18:51:17
Session Start Date/Time	24-APR-2013 18:55:50
Session End Date/Time	24-APR-2013 18:56:08
Session Duration	18

Records Processed Details

Number of Inserts	4
Number of Updates	0
Number of Deletes	0
Number of Errors	0
Number of rows processed	7066

Oracle GoldenGate Configuration

Oracle Utilities Analytics uses Oracle GoldenGate to capture the changed data. This table is used by the Oracle GoldenGate replication process to track its processing activities. This information is used by the scheduler process to ensure that the warehouse loading tasks only process data that has been synced.

Attribute	Purpose
Configuration code	The code is either be the context code identifying the instance uniquely or B1 for the target data warehouse.
Manager Port	The port that the Oracle GoldenGate Manager Port utilizes.
Dynamic Port Range	A port range that the Oracle GoldenGate process utilizes.
Algorithm	The encryption algorithm to be used. For example, BLOWFISH.
Encryption Key	The name of the key used for encryption/decryption.
Database Host	The host name of the database.
Database Port	The port name for the database.
Database ID	The system identifier for the database.
Database Home	The database home folder where the database software is installed.
GoldenGate Home	The home folder for Oracle GoldenGate.
Shared Secret	The Shared Secret is the shared public key. The Encryption mechanism utilizes a public key private key pair.

Oracle GoldenGate Configuration page in the Administration tool allows you to add, edit, and delete records. As part of the Oracle Utilities Analytics installation process, Oracle GoldenGate configuration records are generated for the configured source application and the target Oracle Utilities Analytics application. You can then use this page to change the configurations.

Maintain Golden Gate Configuration

Main

Configuration Code * ODM1

Manager Port * 7830

Dynamic Port Range Start * 7830

Dynamic Port Range End * 7880

Algorithm * 1

Encryption Key * DEFAULT

Shared Secret * DEFAULT

Golden Gate Home * /bi_oradata_01/GoldenGateHome

Database Connection Details

Database Host * slc03rpv.us.oracle.com

Database Port * 1521

Database SID * W2201XB2

Database Home * /scratch/gbuora/app/gbuora/product/11.2.0Std/dbhome_2

Cancel Delete Save

Global Configuration

This table is used to capture the global settings needed for the Oracle Utilities Analytics product:

Attribute	Purpose
Product	A reference to the product code, identifying the product for this instance. This could be one of the configured source products of the base Oracle Utilities Analytics product itself.
Instance Number	The unique number of the configured source product instance. For the configuration settings of the base Oracle Utilities Analytics product, this value is set to null.
Description	This column describes the purpose of the specific global configuration setting.
Value	The configuration value that users can update based on their setup.
Data Type	The data type of the configuration value that a user is expected to enter.
Data Format	The specific format of the data that a user is expected to enter the configuration value in.

The **Global Configuration** page in the Administration tool allows you to enter a configuration value for each of the configuration setting. As a part of the Oracle Utilities Analytics installation process, the global configuration records are generated for the configured source application and the target Oracle Utilities Business Intelligence application. You can then use this page to change the configurations.

Users are expected to enter the configuration value strictly in the specified data format only. Entering value in other formats will result in errors during the ETL processing.

Global Configuration

Product	Instance Number	Description	Value	Data Type	Data Format
Customer Care and Billing	1	Product Extract Date - The date from which all ETL jobs for the specific product instance will be configured to start the initial load	<input type="text" value="01-Jan-2000"/>	DATE	DD-MON-YYYY
Oracle Utilities Analytics	(None)	Global Extract Date - The date from which all ETL jobs will be configured to start the initial load	<input type="text" value="01-Jan-2000"/>	DATE	DD-MON-YYYY
Oracle Utilities Analytics	(None)	Cut Off Time - The time of the day upto which all changes from the source will be loaded by the ETL jobs	<input type="text"/>	VARCHAR2(20)	HH24.MRSS
Oracle Utilities Analytics	(None)	Enable Partitioning - If a partitioning license has been purchased from Oracle, set this to Y	<input type="text" value="Y"/>	VARCHAR2(1)	YN
Oracle Utilities Analytics	(None)	Database Edition Type - Mention the type of the Oracle Database, whether it is Standard Edition(SE) or Enterprise Edition(EE)	<input type="text" value="SE"/>	VARCHAR2(2)	EE/SE
Oracle Utilities Analytics	(None)	Maximum number of MV interfaces which can run in parallel	<input type="text" value="4"/>	NUMBER	99999
Oracle Utilities Analytics	(None)	Number of days for which the logs would be retained	<input type="text" value="1"/>	NUMBER	99999

1 - 7

Appendix C

Oracle Utilities Customer Care and Billing Extractor Details

This section includes an overview of install and upgrade process, including:

- **Performing Initial Load**
- **ELT for Oracle Utilities Customer Care and Billing Analytics**
- **Oracle Utilities Customer Care and Billing Older Extractors**

Performing Initial Load

Setting up a data warehouse for the first time involves a large volume of data to be transferred from the source application to the target environment. In Oracle Data Integrator based architecture, Oracle GoldenGate is utilized to sync up a selective set of tables from the source system in a schema on the target. This schema is referred as the “Replication” schema.

The initial synchronization requires that the current snapshot of the tables at the source has to be obtained and then applied to the replication schema. To perform this and utilize the database processing power efficiently, an Oracle Data Integrator scenario is provided. This process utilizes Oracle Database's Import/Export over the Database Link feature to perform the initial sync.

To reduce the time taken for this purpose, it is recommended to use a shared mount for export and import; otherwise you will need to use a file transfer mechanism. The database export data pump and import data pump require the directory to be created. The section below assumes the default directory **B1_DATA_PUMP_DIR** is being used for this process.

Create a database directory **B1_DATA_PUMP_DIR** on the target database and the location should be accessible to the database import/export process. This directory is used to store the data pump process log file.

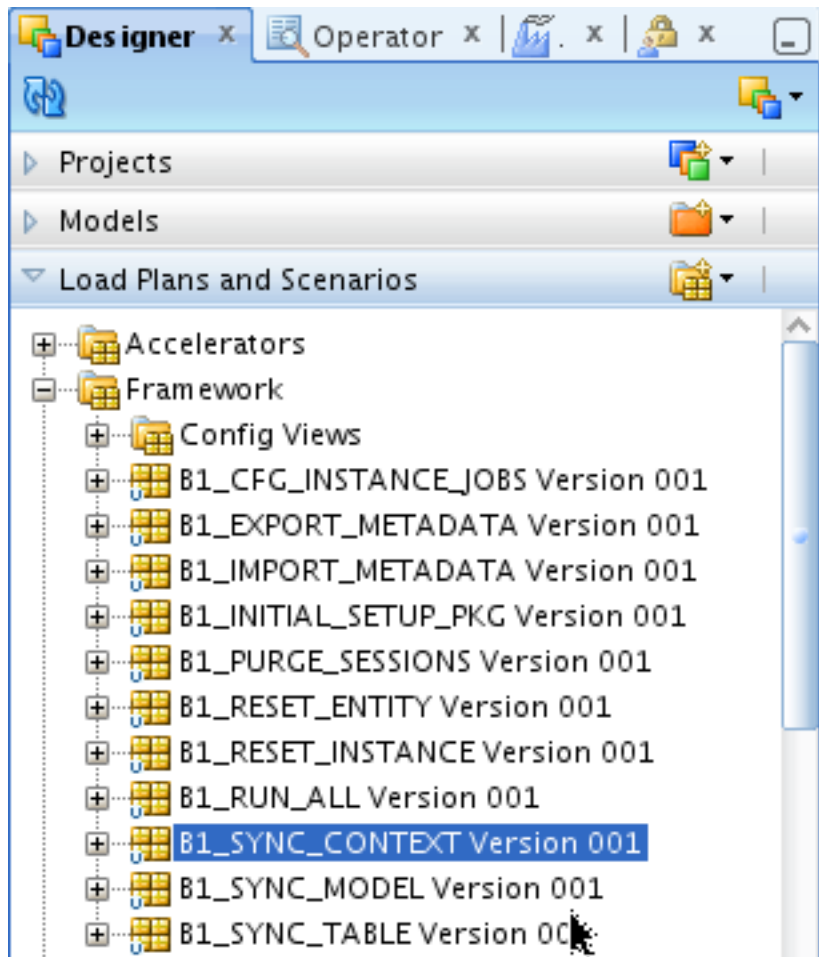

Execute the scenario **B1_SYNC_CONTEXT** while setting up the Oracle GoldenGate replication.

Note: The incremental replication scripts for the source capture and the target apply process should be configured prior to executing this scenario. The sequence of execution is available in the **readme.txt** file generated along with the Oracle GoldenGate scripts.

A global configuration **B1_HIGH_VOL_THRESHOLD** is provided with a default value of 1000,000. This value controls the identification of tables as high volume or low volume. A high volume table processes in its own thread and this allows the high volume tables to be processed in parallel. This value is configurable and can be changed prior to execution of the scenario.

Note: Executing this scenario in GLOBAL context will perform the initial sync of all contexts assuming that the Oracle GoldenGate scripts have been deployed and replicate process is stopped for all the contexts.

Executing this scenario for a specific context (ex CCB1) will initiate the initial sync only for the models in the specified context

If Oracle GoldenGate scripts have not been set up, the job will complete, but will not sync any data. Ensure that there are records in the **B1_CHECKPOINT** table in the metadata schema with group name corresponding to each model created for the specific context.

The status of extract and load for each table of the model can be checked by querying the table **B1_TABLE_SYNC** in the metadata schema post execution.

The status of the sync process for each context can be checked by querying the table **CDC_SYNC_LOG** in the replication schema. The table provides log of process including the start and end timestamps of the process.

ELT for Oracle Utilities Customer Care and Billing Analytics

Oracle Utilities Analytics v2.5.0.0.1 only supports Oracle Data Integrator based ELT for Oracle Utilities Customer Care and Billing Analytics. When upgrading from previous version of Oracle Utilities Analytics, all Oracle Warehouse Builder components that were provided in the out-of-the-box solution will be removed from the Oracle Warehouse Builder repository. This will also include removal of deployed components.

Components for shared dimension will not be removed from the repository as these objects will be still used for Oracle Utilities Meter Data Management, or Oracle Utilities Workforce Asset Management source applications, which will continue to be Oracle Warehouse Builder based until a future release.

If you have extended any of the base product Oracle Utilities Customer Care and Billing facts or dimension using the user defined columns, then customization will have to be done in the Oracle Data Integrator based ELT as well.

If you have implemented custom facts and dimensions, then your components will not be impacted by this change. However, it is recommended that you immediately migrate the custom code to Oracle Data Integrator based solution. Refer to the **Appendix C: Oracle Utilities Customer Care and Billing Extractor Details** on how to extend the Oracle Utilities Analytics product.

Oracle Utilities Customer Care and Billing Older Extractors

As of Oracle Utilities Customer Care and Billing V2.4.0.1, the older extractors, which were based on the batch control jobs, have been deprecated and the detailed description is updated with “Only supported for BI 2.4.0 and below.” The corresponding triggers, which served as the Change Data Capture mechanism for the batch jobs, will also be disabled.

Going forward all new functionality for extracting data from Oracle Utilities Customer Care and Billing will be developed using Oracle Data Integrator based ELT architecture.

Appendix D

Oracle Utilities Work and Asset Management Extractor Details

This section includes the details for the Oracle Utilities Work and Asset Management extractors used in Oracle Utilities Work and Asset Management (WAM) edge application:

Fact/Dimension Table Name	Batch Control Name	Source Table Name	Trigger Name	UDFs/UDMs being used
CD_ASSET	EXTDASSET	SA_ASSET	SDBT_BI_ADIU_ASSET	UDF1: Asset Class UDF2: Criticality UDF3: Building UDF4: Location UDF5: Process UDF6: Asset Record Type UDF7: Facility UDF8: Organization UDF9: Company
CD_CREW	EXTDWRKC	SA_CREW	SDBT_BI_ADIU_CREW	
CD_FAILURE	EXTDFAIL	SA_AUTHORITY	SDBT_BI_ADIU_FAILURE	
CD_OP_ACCT	EXTDOPAC	SA_ACCOUNT_DATA	SDBT_BI_ADIU_ACCT_DATA	UDF1: Area UDF2: Facility UDF3: Organization UDF4: Company UDF5: Level-1 Department UDF6: Level-2 Department UDF7: Level-3 Department
CD_OP_ACTG_TY	EXTDOATT	SA_AUTHORITY	SDBT_BI_ADIU_OP_ACTG_TR_TY	
CD_OP_EXP	EXTDOPEX			UDF1: Expense Category UDF2: Facility
CD_OP_UOM	EXTDOUOM	SA_AUTHORITY	SDBT_BI_ADIU_OUOM	

Fact/Dimension Table Name	Batch Control Name	Source Table Name	Trigger Name	UDFs/UDMs being used
CD_PLANNER	EXTDWRKP	SA_RULE_KEY	SDBT_BI_ADIU_RULE_KEY_PLAN	
CD_REPAIR	EXTDREPR	SA_AUTHORITY	SDBT_BI_ADIU_REPAIR	UDF1: Facility
CD_ROOT_CAUSE	EXTDROOT	SA_AUTHORITY	SDBT_BI_ADIU_ROOT_CAUSE	
CD_STOCK_ITMTY	EXTDSITE	SA_STOREROOM_LOG	SDBT_BI_AI_STRM_LOG	UDF1: Stock Type UDF2: Stock Class UDF3: Commodity Category UDF4: Commodity Name UDF5 Commodity UDF6: Facility
CD_STRM	EXTDSTRM	SA_STOREROOM_SETUP	SDBT_BI_ADIU_STRM_SETUP	UDF1:Storeroom Type UDF2: Facility UDF3: Organization UDF4: Company
CD_STRM_TR_TY	EXTDSTTT	SA_STOREROOM_LOG	SDBT_BI_AI_STRM_LOG	
CD_WRKORD_TY	EXTDWOTY	SA_AUTHORITY	SDBT_BI_ADIU_WRK_ORD_TYPE	
CF_OP_ACTG	EXTFOPAT	SA_AUTHORITY	SDBT_BI_ADIU_OP_ACTG_TR_TY	
CF_STRM_INV	EXTFSTOR	SA_STOREROOM_SETUP	SDBT_BI_ADIU_STRM_SETUP	
CF_STRM_TR	EXTFSTTR	SA_STOREROOM_LOG	SDBT_BI_AI_STRM_LOG	
CF_WRKORD_TK	EXTFWRKT	SA_WORK_ORDER_TASK	SDBT_BI_WORK_ORDER_TASK	UDM1: Days Late UDM2: Days to close UDM3: Scheduled Downtime Indicator

Appendix E

Oracle Utilities Meter Data Management Extractor Details

This section contains details regarding each fact and dimension from Oracle Utilities Meter Data Management (MDM) edge application for synchronization BO-based extract and idiosyncratic batch extract, as shown below:

- **Synchronization BO-Based Extract Details**
- **Idiosyncratic Batch Extract Details**

Synchronization BO-Based Extract Details

Fact / Dimension Table Name	Initial Load Batch Control	Extract Batch Control	Sync BO	Extension
CF_DEVICE_EVT	D1-DEVIL	D1-DEVFX	D1- DeviceEventFact	Via Element Population Rules and Post Service Script on the Sync BO
CF_INSTALL_EVT	D1-INEIL	D1-INEFX	D1- InstallEventFact	Via Element Population Rules and Post Service Script on the Sync BO
CF_SP	D1-SPIL	D1-SPAFX	D1-SPAccumulationFact	Via Element Population Rules and Post Service Script on the Sync BO
CF_DEVICE_ACTIVITY	D1-ACTIL	D1-ACTFX	D1-ActivityAccumulationFact	Via Element Population Rules and Post Service Script on the Sync BO
CD_CONS_TYPE	D2-CSTIL	D2-CSTDX	D2- ConsumSnapshotTypeDimension	Via Element Population Rules and Post Service Script on the Sync BO
CD_MTR_DEVICE	D1-DVCIL	D1-DVCDX	D1-DeviceDimension	Via Element Population Rules and Post Service Script on the Sync BO
CD_MC	D1-MCIL	D1-MCDX	D1- MeasuringComponentDimension	Via Element Population Rules and Post Service Script on the Sync BO
CD_SPR	D1-SPRIL	D1-SPRDX	D1-ServiceProviderDimension	Via Element Population Rules and Post Service Script on the Sync BO
CD_SP	D1-SPIL	D1-SPDX	D1-SPDimension	Via Element Population Rules and Post Service Script on the Sync BO
CD_ADDR	D1-SPIL	D1-ADRDX	D1-AddressDimension	Via Element Population Rules and Post Service Script on the Sync BO
CD_US	D2-USIL	D2-USDX	D2-USDimension	Via Element Population Rules and Post Service Script on the Sync BO
CD_USAGE_GROUP	D2-UGIL	D2-UGDX	D2-UsageGroupDimension	Via Element Population Rules and Post Service Script on the Sync BO
CD_CONTACT	D2-CONIL	D2-CONDX	D2-ContactDimension	Via Element Population Rules and Post Service Script on the Sync BO
CD_MSRMT_COND	D2-MRCIL	D2-MRCDX	D2-MsrmtConditionDimension	Via Element Population Rules and Post Service Script on the Sync BO

Fact / Dimension Table Name	Initial Load Batch Control	Extract Batch Control	Sync BO	Extension
CD_IE_STATUS	D1-IESIL	D1-IESDX	D1-IEBOSStatusAndReasnDimension	Via Element Population Rules and Post Service Script on the Sync BO
CD_SP_STATUS	D1-SPSIL	D1-SPSDX	D1-SPBOSStatusAndReasnDimension	Via Element Population Rules and Post Service Script on the Sync BO
CD_DAYS_LAST_MSRMT	D1-LNMIL	D1-LNMDX	D1-DaysSinceLastNormalMsrmtDim	Via Element Population Rules and Post Service Script on the Sync BO
CD_EXCP_TYPE	D2-EXTIL	D2-EXTDX	D2-ExceptionTypeDimension	Via Element Population Rules and Post Service Script on the Sync BO
CD_VEE_RULE	D2-VERIL	D2-VERDX	D2-VEERuleDimension	Via Element Population Rules and Post Service Script on the Sync BO
CD_DEVICE_ACTIVITY_STATUS	D1-ACSIL	D1-ACSDX	D1-ActivityBOSStatusAndReasnDim	Via Element Population Rules and Post Service Script on the Sync BO
CD_DEVICE_ACTIVITY_TYPE	D1-ATYIL	D1-ATYDX	D1-ActivityTypeDimension	Via Element Population Rules and Post Service Script on the Sync BO
CD_DEVICE_EVT_STATUS	D1-DESIL	D1-DESDX	D1-DEBOSStatusAndReasnDimension	Via Element Population Rules and Post Service Script on the Sync BO
CD_DEVICE_EVT_TYPE	D1-DEUIL	D1-DETDX	D1-DeviceEventTypeDimension	Via Element Population Rules and Post Service Script on the Sync BO
CD_SP_UT_AGE_TYPE	D2-UTAIL	D2-UTADX	D2-SPUTAggingTypeDimension	Via Element Population Rules and Post Service Script on the Sync BO
CD_DAYS_LASTUT_TYPE	D2-LUTIL	D2-LUTDX	D2-DaysSinceLastUTDimension	Via Element Population Rules and Post Service Script on the Sync BO

Idiosyncratic Batch Extract Details

Fact / Dimension Table Name	Initial Load Batch Control	Extract Batch Control	Sync BO	Extension
CF_CONSUMPTION	D2-SPCFX	Usage Snapshot	D2-SP-CA	Via new snapshot algorithm
CF_SP_SNAP	D1-SPSFX	Service Point Snapshot	D1-SPSNAP-SE	Via Post Service Script on the snapshot algorithm's parameter
CF_SP_UT_AGE	D2-SUAFX	Unreported Usage Analysis Snapshot	D2-SP-UT-AGE	Via new snapshot algorithm
CF_VEE_EXCP	D2-SVEFX	SP VEE Exception Snapshot	D2-SPVEEEXC	Via new snapshot algorithm
CD_UOM_TOU	D2-UTIL	n/a	n/a	Via Post Service Script on the batch control parameter
CD_UOM_TOU_SQI	D2-UTSIL	n/a	n/a	Via Post Service Script on the batch control parameter
CD_IMD_TYPE	D2-ITLIL	n/a	n/a	No extension
CD_EXCP_SEV	D2-EXLIL	n/a	n/a	No extension

Appendix F

Oracle Utilities Mobile Workforce Management Extractor Details

The chapter contains summary of the batch programs and sync Business Objects (BO) for each fact/dimension used in Oracle Utilities Mobile Workforce Management (MWM) edge application:

Fact /Dimension Table Name	Initial Load Batch Control	Extract Batch Control	Sync BO
CD_CREW_SHIFT	M1-SFTIL	M1-CRSDX	M1-CrewShiftDimension
CD_CREW_TM_USG	M1-CTUIL	M1-CTUDX	M1-CrewTimeUsageDimension
CD_APPT_TM	M1-APTIL	M1-APTDX	M1-AppointmentTimeDimension
CD_APPT_TM_OF_DAY	M1-ATDIL	M1-ATDDX	M1-AppointmentTmOfDayDimension
CD_TRAVEL_DIST_DEV	M1-TDDIL	M1-TADDX	M1-TravelDurDeviationDimension
CD_SERVICE_AREA	M1-SERIL	M1-SERDX	M1-ServiceAreaDimension
CD_CREW	M1-CREIL	M1-CREDX	M1-CrewDimension
CD_TASK_TYPE	M1-TKTIL	M1-TKTDX	M1-TaskTypeDimension
CD_ADDR	M1-LOCIL,M1-CSAIL,M1-TKAIL	M1-ADRDY	M1-AddressDimension
CD_SHIFT_BO_STATUS	M1-SBSIL	M1-SBSDX	M1-ShiftBoStatusResDimension
CD_TASK_BO_STATUS	M1-TBSIL	M1-TBSDX	M1-TaskBoStatusReasonDimension
CD_LATE_LOGON_TM	M1-LLTIL	M1-LLTDX	M1-LateLogonTimeDimension
CD_EARLY_LOGOFF	M1-ELTIL	M1-ELTDX	M1-EarlyLogoffTimeDimension
CD_TRAVEL_DUR_DEV	M1-TADIL	M1-TDDDX	M1-TravelDistDevDimension
CD_WORK_DUR_DEV	M1-WDDIL	M1-WDDDX	M1-WorkDurationDevtnDimension
CD_RESP_TM_DEV	M1-RTDIL	M1-RTDDX	M1-RespTimeDevDimension
CF_FLD_ACTIVITY	M1-ACTIL	M1-ACTFX	M1-ActivityFact
CF_CMP_SHIFT	M1-SFTIL	M1-CCSFX	M1-CompletedShiftFact
CF_CREW_TASK	M1-SFTIL	M1-CRTFX	M1-CrewTaskFact

Appendix G

Oracle Utilities Network Management System Extractor Details

This section contains a summary of the extract scripts and the corresponding view names for each fact and dimension used in Oracle Utilities Network Management System (NMS) edge application:

Table Name	Extract Program	Extract Procedure	Modify View	Delete View
CD_ACCT	bi_customer_extractor	PR_BI_EXTTOACCT	EXTOACCT_MODIFY_V	EXTOACCT_DELETE_V
CD_ADDR	bi_customer_extractor	PR_BI_EXTTOADDR	EXTOADDR_MODIFY_V	EXTOADDR_DELETE_V
CD_CALL_INFO	bi_event_extractor AND nrt_extractor	PR_BI_EXTCINFO	EXTCINFO_MODIFY_V	EXTCINFO_DELETE_V
CD_CREW	bi_common_extractor	PR_BI_EXTTOACCT	EXTOCREW_MODIFY_V	EXTOCREW_DELETE_V
CD_CTRL_ZONE	bi_common_extractor	PR_BI_EXTZONE	EXTZONE_MODIFY_V	EXTZONE_DELETE_V
CD_DEVICE	bi_common_extractor	PR_BI_EXTDEV	EXTDEV_MODIFY_V	EXTDEV_DELETE_V
CD_EVENT	bi_event_extractor AND nrt_extractor	PR_BI_EXTJOB	EXTJOB_MODIFY_V	EXTJOB_DELETE_V
CD_EVENT_STATU S	bi_common_extractor	PR_BI_EXTESTAT	EXTESTAT_MODIFY_V	EXTESTAT_DELETE_V
CD_FEEDER	bi_feeder_extractor	PR_BI_EXTFDR	EXTFDR_MODIFY_V	EXTFDR_DELETE_V
CD_METER	bi_customer_extractor	PR_BI_EXTOMTR	EXTOMTR_MODIFY_V	EXTOMTR_DELETE_V
CD_PER	bi_customer_extractor	PR_BI_EXTOPER	EXTOPER_MODIFY_V	EXTOPER_DELETE_V
CD_PHASE	bi_feeder_extractor	PR_BI_EXTPHASE	EXTPHASE_MODIFY_V	
CD_PREM	bi_customer_extractor	PR_BI_EXTOPREM	EXTOPREM_MODIFY_V	EXTOPREM_DELETE_V
CD_SNL	bi_customer_extractor	PR_BI_EXTCSP	EXTCSP_MODIFY_V	EXTCSP_DELETE_V
CD_STORM	bi_event_extractor and nrt_extractor	PR_BI_EXTSTORM	EXTSTORM_MODIFY_V	EXTSTORM_DELETE_V

Table Name	Extract Program	Extract Procedure	Modify View	Delete View
CD_STORM_OUTAGE_TYPE	bi_common_extractor and bi_event_extractor	PR_BI_EXTSTORM OT	EXTSTORMOT_MODIFY _V	
CD_SW_PLAN	bi_switch_extractor	PR_BI_EXTSWSD	EXTSWSD_MODIFY_V	EXTSWSD_DELETE_V
CD_SW_PLAN_STATE	bi_switch_extractor	PR_BI_EXTVALST	EXTVALID_STATES_MO DIFY_V	
CD_USER	bi_common_extractor	PR_BI_EXTTOUSER	EXTTOUSER_MODIFY_V	EXTTOUSER_DELETE _V
CF_CUST_RECENT_OUTG	nrt_extractor	PR_BI_NRTCOT	NRTSNL_MODIFY_V	EXTSNL_DELETE_V
CF_CUST_RST_OUTG	bi_event_extractor	PR_BI_EXTCOF	EXTSNL_MODIFY_V	EXTSNL_DELETE_V
CF_FEEDER_DLVR_LOAD	bi_feeder_extractor	PR_BI_EXTFDRLD	EXTFDRLD_MODIFY_V	
CF_RECENT_CALL	nrt_extractor	PR_BI_NRTINC	EXTINC_MODIFY_V	EXTINC_DELETE_V
CF_RECENT_CREW	nrt_extractor	PR_BI_NRTCROWA	EXTCROWA_MODIFY_V	
CF_RST_CREW	bi_event_extractor	PR_BI_EXTCROWA	EXTCROWA_MODIFY_V	
CF_RST_JOB	bi_event_extractor	PR_BI_EXTJOBOT	EXTJOBOT_MODIFY_V	EXTJOBOT_DELETE_V
CF_SW_PLAN	bi_switch_extractor	PR_BI_EXTSWS	EXTSWS_MODIFY_V	EXTSWS_DELETE_V
CF_SW_PLAN_STATE	bi_switch_extractor	PR_BI_ EXTSWSLOG	EXTSWSLOG_MODIFY_ V	

Appendix H

Oracle Utilities Validation Functions and Error Identification Procedure Names

This section lists the names for the validation functions and error identification procedure names for all the facts, along with the CM error procedure name and validation function name for those facts if you want to add more validations:

Fact Name	Error Procedure Name	Validation Function Name	Custom Error Procedure Name	UDFs/UDMs being used
CF_ARREARS	B1_ERR_F_ARREARS	B1_VAL_F_ARREARS	CM_ERR_F_ARREARS	CM_VAL_F_ARREARS
CF_BILLED_USAGE	B1_ERR_F_BILLED_USAGE	B1_VAL_F_BILLED_USAGE	CM_ERR_F_BILLED_USAGE	CM_VAL_F_BILLED_USAGE
CF_CASE	B1_ERR_F_CASE	B1_VAL_F_CASE	CM_ERR_F_CASE	CM_VAL_F_CASE
CF_CASE_LOG	B1_ERR_F_CASE_LOG	B1_VAL_F_CASE_LOG	CM_ERR_F_CASE_LOG	CM_VAL_F_CASE_LOG
CF_CC	B1_ERR_F_CC	B1_VAL_F_CC	CM_ERR_F_CC	CM_VAL_F_CC
CF_CMP_SHIFT	B1_ERR_F_CMP_SHIFT	B1_VAL_F_CMP_SHIFT	CM_ERR_F_CMP_SHIFT	CM_VAL_F_CMP_SHIFT
CF_COLL_EVT	B1_ERR_F_CUTEV	B1_VAL_F_CUTEV	CM_ERR_F_CUTEV	CM_VAL_F_CUTEV
CF_COLL_EVT	B1_ERR_F_SEV_EVT	B1_VAL_F_SEV_EVT	CM_ERR_F_SEV_EVT	CM_VAL_F_SEV_EVT
CF_COLL_EVT	B1_ERR_F_ODEV	B1_VAL_F_ODEV	CM_ERR_F_ODEV	CM_VAL_F_ODEV
CF_COLL_EVT	B1_ERR_F_COLL_EVT	B1_VAL_F_COLL_EVT	CM_ERR_F_COLL_EVT	CM_VAL_F_COLL_EVT
CF_COLL_PROC	B1_ERR_F_COLL_PROC	B1_VAL_F_COLL_PROC	CM_ERR_F_COLL_PROC	CM_VAL_F_COLL_PROC
CF_COLL_PROC	B1_ERR_F_ODPR	B1_VAL_F_ODPR	CM_ERR_F_ODPR	CM_VAL_F_ODPR
CF_CONSUMPTION	B1_ERR_F_CONSUMPTION	B1_VAL_F_CONSUMPTION	CM_ERR_F_CONSUMPTION	CM_VAL_F_CONSUMPTION
CF_CREW_TASK	B1_ERR_F_CREW_TASK	B1_VAL_F_CREW_TASK	CM_ERR_F_CREW_TASK	CM_VAL_F_CREW_TASK
CF_CUST_RECENT_OUTG	B1_ERR_F_CUST_RECENT_OUTG	B1_VAL_F_CUST_RECENT_OUTG	CM_ERR_F_CUST_RECENT_OUTG	CM_VAL_F_CUST_RECENT_OUTG
CF_CUST_RST_OUTG	B1_ERR_F_CUST_RST_OUTG	B1_VAL_F_CUST_RST_OUTG	CM_ERR_F_CUST_RST_OUTG	CM_VAL_F_CUST_RST_OUTG
CF_DEVICE_ACTIVITY	B1_ERR_F_DEVICE_ACTIVITY	B1_VAL_F_DEVICE_ACTIVITY	CM_ERR_F_DEVICE_ACTIVITY	CM_VAL_F_DEVICE_ACTIVITY

Fact Name	Error Procedure Name	Validation Function Name	Custom Error Procedure Name	UDFs/UDMs being used
CF_DEVICE_EVT	B1_ERR_F_DEVICE_EVT	B1_VAL_F_DEVICE_EVT	CM_ERR_F_DEVICE_EVT	CM_VAL_F_DEVICE_EVT
CF_FEEDER_DLVRD_LOAD	B1_ERR_F_FEEDER_DLVRD_LOAD	B1_VAL_F_FEEDER_DLVRD_LOAD	CM_ERR_F_FEEDER_DLVRD_LOAD	CM_VAL_F_FEEDER_DLVRD_LOAD
CF_FLD_ACTIVITY	B1_ERR_F_FLD_ACTIVITY	B1_VAL_F_FLD_ACTIVITY	CM_ERR_F_FLD_ACTIVITY	CM_VAL_F_ARREARS
CF_FT	B1_ERR_F_FT	B1_VAL_F_FT	CM_ERR_F_FT	CM_VAL_F_FT
CF_FT_GL	B1_ERR_F_FT_GL	B1_VAL_F_FT_GL	CM_ERR_F_FT	CM_VAL_F_FT
CF_INSTALL_EVT	B1_ERR_F_INSTALL_EVT	B1_VAL_F_INSTALL_EVT	CM_ERR_F_INSTALL_EVT	CM_VAL_F_INSTALL_EVT
CF_OP_ACTG	B1_ERR_F_OP_ACTG	B1_VAL_F_OP_ACTG	CM_ERR_F_OP_ACTG	CM_VAL_F_OP_ACTG
CF_ORDER	B1_ERR_F_ORDER	B1_VAL_F_ORDER	CM_ERR_F_ORDER	CM_VAL_F_ORDER
CF_PAY_TNDR	B1_ERR_F_PAY_TNDR	B1_VAL_F_PAY_TNDR	CM_ERR_F_PAY_TNDR	CM_VAL_F_PAY_TNDR
CF_RECENT_CALL	B1_ERR_F_RECENT_CALL	B1_VAL_F_RECENT_CALL	CM_ERR_F_RECENT_CALL	CM_VAL_F_RECENT_CALL
CF_RECENT_CREW	B1_ERR_F_RECENT_CREW	B1_VAL_F_RECENT_CREW	CM_ERR_F_RECENT_CREW	CM_VAL_F_RECENT_CREW
CF_RECENT_JOB	B1_ERR_F_RECENT_JOB	B1_VAL_F_RECENT_JOB	CM_ERR_F_RECENT_JOB	CM_VAL_F_RECENT_JOB
CF_RECENT_TD_ENTRY	B1_ERR_F_RECENT_TD_ENTRY	B1_VAL_F_RECENT_TD_ENTRY	CM_ERR_F_RECENT_TD_ENTRY	CM_VAL_F_RECENT_TD_ENTRY
CF_RST_CALL	B1_ERR_F_RST_CALL	B1_VAL_F_RST_CALL	CM_ERR_F_RST_CALL	CM_VAL_F_RST_CALL
CF_RST_CREW	B1_ERR_F_RST_CREW	B1_VAL_F_RST_CREW	CM_ERR_F_RST_CREW	CM_VAL_F_RST_CREW
CF_RST_JOB	B1_ERR_F_RST_JOB	B1_VAL_F_RST_JOB	CM_ERR_F_RST_JOB	CM_VAL_F_RST_JOB
CF_SA	B1_ERR_F_SA	B1_VAL_F_SA	CM_ERR_F_SA	CM_VAL_F_SA
CF_SP	B1_ERR_F_SP	B1_VAL_F_SP	CM_ERR_F_SP	CM_VAL_F_SP
CF_SP_SNAP	B1_ERR_F_SP_SNAP	B1_VAL_F_SP_SNAP	CM_ERR_F_SP_SNAP	CM_VAL_F_SP_SNAP
CF_SP_UT_AGE	B1_ERR_F_SP_UT_AGE	B1_VAL_F_SP_UT_AGE	CM_ERR_F_SP_UT_AGE	CM_VAL_F_SP_UT_AGE
CF_STRM_INV	B1_ERR_F_STRM_INV	B1_VAL_F_STRM_INV	CM_ERR_F_STRM_INV	CM_VAL_F_STRM_INV
CF_STRM_TR	B1_ERR_F_STRM_TR	B1_VAL_F_STRM_TR	CM_ERR_F_STRM_TR	CM_VAL_F_STRM_TR
CF_SW_PLAN	B1_ERR_F_SW_PLAN	B1_VAL_F_SW_PLAN	CM_ERR_F_SW_PLAN	CM_VAL_F_SW_PLAN
CF_SW_PLAN_STATE	B1_ERR_F_SW_PLAN_STATE	B1_VAL_F_SW_PLAN_STATE	CM_ERR_F_SW_PLAN_STATE	CM_VAL_F_SW_PLAN_STATE
CF_TD_ENTRY	B1_ERR_F_TD_ENTRY	B1_VAL_F_TD_ENTRY	CM_ERR_F_TD_ENTRY	CM_VAL_F_TD_ENTRY
CF_UCOL_EVT	B1_ERR_F_UCOL_EVT	B1_VAL_F_UCOL_EVT	CM_ERR_F_UCOL_EVT	CM_VAL_F_UCOL_EVT
CF_UCOL_PROC	B1_ERR_F_UCOL_PROC	B1_VAL_F_UCOL_PROC	CM_ERR_F_UCOL_PROC	CM_VAL_F_UCOL_PROC
CF_VEE_EXCP	B1_ERR_F_VEE_EXCP	B1_VAL_F_VEE_EXCP	CM_ERR_F_VEE_EXCP	CM_VAL_F_VEE_EXCP
CF_WRKORD_TK	B1_ERR_F_WRKORD_TK	B1_VAL_F_WRKORD_TK	CM_ERR_F_WRKORD_TK	CM_VAL_F_WRKORD_TK

Appendix I

Oracle Warehouse Builder ETL Components

This section covers Oracle Warehouse Builder ETL components, including:

- **External Table**
- **Mapping**
- **Workflow**
- **Packages**
- **File Manager**

External Table

The extract programs execute in the source application. They produce flat files that contain the data extracted from the source system. Each process creates:

- A single-record control file that contains information about the entire batch job.
- Data files that contain the information to be loaded into the warehouse. These files are also referred to as the staging files.

Oracle external tables are defined in the warehouse for each type of control and data file. Specifically, two external tables are defined for each fact and dimension that is loaded from flat files. These external tables provide a SQL-based interface to the data in the flat files by the data mappings. A data mapping exists for each fact and dimension.

Within Oracle database, the external tables have the following naming formats:

- STG_<table_name>_EXT for the data files.
- STG_<table_name>_CTL_EXT for the control files that are used to load a specific table.

For example, the external tables used to load the CD_ACCT table are named STG_ACCT_EXT and STG_ACCT_CTL_EXT.

The flat file names are different from the name of the external tables. The standard format for the file names are table_name_EXT.DAT and table_name_EXT.CTL. So for the CD_ACCT table, the files are named as D_ACCT_EXT.DAT and D_ACCT_EXT.CTL.

Note: Refer to the *Oracle Utilities Analytics Data Mapping Guides* for the respective source application for the list of file names for each fact and dimension.

Mapping

The data mappings load data from the external tables (produced by the extracts) into the facts and dimensions in the warehouse.

Note: For a list of the facts and dimensions, their external tables, and the related data mappings, refer to the data mapping guide for your source application. This document describes the source application's facts and dimensions and how they are populated.

Workflow

A separate process flow exists to execute each mapping along with the pre-mapping and post-mapping processes. The following diagram shows a typical process flow:

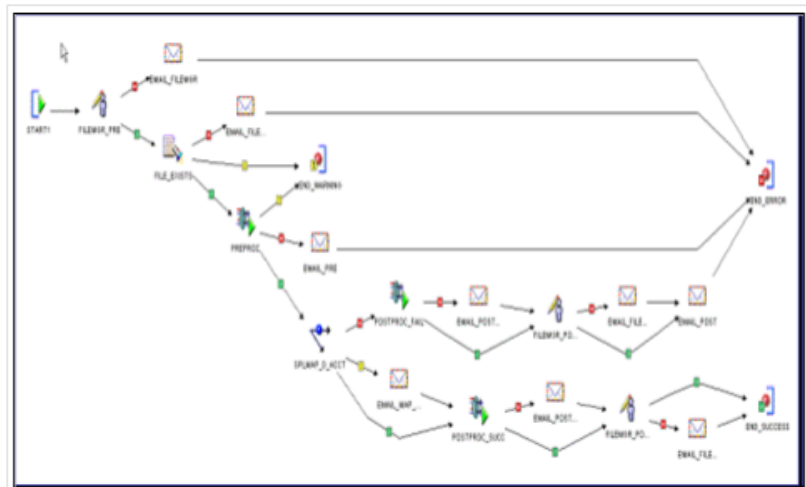

Each data load process flow is designed to:

- Execute the file manager to perform housekeeping on the data and control files in pre-mapping and post-mapping modes.
- Execute the pre-mapping and post-mapping functions to validate, load, and maintain batch information in the ETL job control transaction.
- Execute the data mappings once the file is available and validated.
- Send an email if an error occurs. Also, if an error occurs before the mapping executes, the process flow aborts the complete process. Otherwise, it sends an email and continues. The process flow modules allow you to group process flow packages.

Packages

The process flow packages allow you to group process flows. Together, the process flow modules and packages provide two levels to manage and deploy process flows. You can validate, generate, and deploy process flows at either the module or the package level. All process flows are presently grouped under the following packages for easier administration:

- **INIT_PKG:** This package contains the process flows to load the default records into the dimensions. It also contains the process flows to load the date and time dimensions, and includes the purge workflow.
- **DIM:** This package contains the process flows for dimensions delivered in Oracle Utilities Analytics.

- **DIM_MDM:** This package contains the process flows for dimensions delivered in Oracle Utilities Analytics for all Oracle Utilities Meter Data Management dimension tables.
- **DIM_MWM:** This package contains process flows for dimensions delivered in Oracle Utilities Analytics for all Oracle Utilities Mobile Workforce Management dimension tables.
- **DIM_UDD:** This contains the process flows for all user-defined dimensions delivered in Oracle Utilities Analytics.
- **FACT:** This package contains the process flows to load all of the fact tables in Oracle Utilities Analytics.
- **FACT_MDM:** This package contains the process flows for facts delivered in Oracle Utilities Analytics for all Oracle Utilities Meter Data Management fact tables.
- **FACT_MWM:** This package contains the process flows for facts delivered in Oracle Utilities Analytics for all Oracle Utilities Mobile Workforce Management fact tables.
- **MV_RFSH:** This package contains the process flows to refresh the default materialized views created for each fact table. If custom materialized views are created, then a copy of the fact table process flow should be created and the new materialized view refresh added to the copied process flow. Note that the refresh of the materialized views are done in parallel.
- **LOADRFSH:** This package contains the process flows to load a fact table and then refresh the materialized views for that fact table. A load refresh the process flow initiates the load for facts and subsequently executes the related materialized view refresh using the process flows under the package 'MV_RFSH'.

Note the following about the various the process flows:

- The process flows can be scheduled for execution using the File Processor daemon.
- The process flows for dimensions must be executed before the fact process flows.
- Each process flow executes its data mapping using parallel set-based processing with a commit frequency set to 0.

File Manager

The file manager is a PERL program that resides on the database server. The program is responsible for performing housekeeping activities against the files holding the extracted information. It also ensures that the files are supplied in the correct order.

The program accepts the following parameters:

- The name of the file that the external table reads the data from. This name should match the value of the flat file name without the file extension. So for the load of the CD_ACCT table, this would be D_ACCT_EXT.
- File-Name parameter on the extract batch program.
- The location of the files.
- The program can be executed in pre-mapping and post-mapping modes.
- Processing condition (success or failure).
- In the pre-mapping mode, the file manager performs the following actions
 - Creates “error” and “processed” files inside the folder where the files are located.
 - Sorts to get the name of the earliest control and data files that match the file name specified by the parameter passed.
 - Copies the data file and the control file to the files that the external table reads. This is required because the external tables are defined to read data from one particular file and

the extractor programs insert the data source indicator, batch number, and batch thread number in the data and control file names to avoid overwriting the generated files.

- Saves the name of the file being processed in a temporary file. This file is used later in the post-mapping stage to identify the name of the file that was processed. It is also used by the subsequent executions to know if a file is being processed.

In post-mapping mode, depending on the processing condition specified, the file manager moves the processed control and data file to either the error or the processed folder. It also removes the temporary file created in the pre-mapping mode.

Appendix J

Oracle Warehouse Builder Deployment

This section covers the details on how to generate and deploy the Oracle Warehouse Builder code for the ETL of new star schemas. It includes:

- **Oracle Warehouse Builder Code Generator**
- **Deploying TCL Files**
- **Scheduling New Workflows**

Oracle Warehouse Builder Code Generator

The Oracle Warehouse Builder (OWB) Code Generator is used to create OMBPlus TCL scripts. The **OMBPlus** is an Oracle Warehouse Builder scripting language that can create, alter, delete, and deploy Oracle Warehouse Builder objects. The **GenOWB.exe** program is located in the database package in the scripts folder.

The **GenOWB.exe** program must be run on a Windows machine that can connect to the data warehouse database. Use the following syntax to run the Oracle Warehouse Builder Code Generator:

The parameters and related values in the **GenOWB.exe** are described below:

```
GenOWB.exe -d <DBInfo> -t <TableName> -m <Mapping/Workflow  
StagingTables/Facts/Dimension/All> -a <Dimensions/Facts/All> -h -g
```

The parameters and related values in the **GenOWB.exe** are described below:

Parameter	Value
-d	Database Information: Database User ID, password, database TNS name (for example, dwadm, dwadm, or bivmdv)
-t	Name of dimension or fact tables

Parameter	Value
-m	Generate the following: <ul style="list-style-type: none"> • Mapping (M) • WorkFlow (W) • Staging Tables (S) • Sequences (Q) • Facts (F) • Dimensions (D) • All (A)
-a	Generate mapping/Workflow/Staging Tables/Sequences/Cubes/Dimensions for all (D)imension Tables, all (F)act tables or (A)ll Dimension and Fact tables (D/F/A)
-x	DROP statement: (Y)es or (N)o. The default is No.
-h	Help
-g	generate debug info

When the Oracle Warehouse Builder (OWB) Code Generator is run for a table, the following files are generated:

- **seq_nam.TCL:** A file that creates the sequence in Oracle Warehouse Builder (OWB) used for the primary key of the table to be loaded. For example, the SPL_ACCT_SEQ.TCL file creates the sequence used to populate the primary key of the CD_ACCT table. Note that the sequence is also created manually in the database, as it is not recommended to deploy sequences from Oracle Warehouse Builder (OWB) to the database.
- **tbl_name.TCL:** A file that creates the table definition in Oracle Warehouse Builder. For example, the CD_ACCT.TCL script creates the CD_ACCT table in Oracle Warehouse Builder. Note that tables are also created manually in the database, as it is not recommended to deploy tables from Oracle Warehouse Builder to the database.
- **stg_file_name.TCL:** A file that creates the data file definition in Oracle Warehouse Builder. For example, the STG_ACCT_FF.TCL creates the definition of the CD_ACCT extract file.
- **ctl_file_name.TCL:** A file that creates the control file definition in Oracle Warehouse Builder. For example, the STG_ACCT_CTL_FF.TCL creates the definition of the CD_ACCT control file.
- **stg_tbl_name.TCL:** A file that creates the data file external table definition in Oracle Warehouse Builder. For example, the STG_ACCT_EXT.TCL creates the definition of the CD_ACCT external table STG_ACCT_EXT.
- **ctl_tbl_name.TCL:** A file that creates the control file external table definition in Oracle Warehouse Builder. For example, the STG_ACCT_CTL_EXT.TCL creates the definition of the CD_ACCT control table STG_ACCT_CTL_EXT.
- **owb_map_name.TCL:** A file that creates Oracle Warehouse Builder mapping, which loads the data from the external table into the data warehouse table. For example, the SPLMAP_D_ACCT.TCL script creates the SPLMAP_D_ACCT mapping, which reads records from the STG_ACCT_EXT and STG_ACCT_CTL_EXT files and loads the extracted records into the CD_ACCT table.

- **owb_wf_name.TCL:** A file that creates the process flow, which takes an extract file and loads it into the fact or dimension table. For example, the SPLWF_D_ACCT.TCL creates the SPLWF_D_ACCT process flow, which checks to see if an account extract file exists in the data load directory, and if it exists, then loads it into the CD_ACCT table.
- **OUBI_LDRF_wf_name.TCL:** A file that is created only for fact loads. It creates a process flow, which calls the data file loading process flow and the materialized view refresh process flow sequentially. For example, the OUBI_LDRF_FT.TCL file creates the OUBI_LDRF_FT process flow that calls the SPLWF_F_FT and OUBI_RFSH_FT process flows.

Note: To create this process flow, the materialized view refresh process flow must exist.

Depending on which Oracle Warehouse Builder objects are changed, the parameters to the **GenOWB.exe** program is modified.

In the previous example, for the CF_CASE table change, the following two commands are run:

The first command shown above creates the SPLMAP_F_CASE.TCL file and the second command creates the SPLWF_F_CASE.TCL and OUBI_LDRF_CASE.TCL files, with drop commands in each file since the objects already exist in the Oracle Warehouse Builder repository.

```
GenOWB.exe -d spluser,spluser_pw,BICONN -t CF_CASE -m M -x Y
GenOWB.exe -d spluser,spluser_pw,BICONN -t CF_CASE -m W -x Y
```

The first command shown above creates the SPLMAP_F_CASE.TCL file and the second command creates the SPLWF_F_CASE.TCL and OUBI_LDRF_CASE.TCL files, with drop commands in each file since the objects already exist in the Oracle Warehouse Builder repository.

Deploying TCL Files

Once the TCL scripts are created, they need to be loaded into the Oracle Warehouse Builder repository using OMBPlus. The OMB Plus is a flexible, high-level command line metadata access tool for Oracle Warehouse Builder. Use OMB Plus to create, modify, delete, and retrieve object metadata in Warehouse Builder design and runtime repositories.

Note: For more information about OMBPlus, refer to the Oracle Warehouse Builder API and Scripting Reference document.

To open an OMBPlus window, in the OWB Design Center select **View->OMB*Plus**.

From within the OMBPlus window, there are many OMBPlus commands available, but the following commands are usually used:

- `cd SOURCE_DIRECTORY`
- `source TCL_FILE`

Note that OMBPlus is case sensitive, so that the commands must be specified in lowercase. Also, the '\' is an escape character in OMBPlus, so within a directory name, two '\'s must be used if it is needed.

To load the files that would have been created by using the commands in the previous section, assume that the TCL files are in the c:\bi\tcl directory. The following OMBPlus commands can be used to load the files:

```
cd c:\\bi\\tcl
source SPLMAP_F_CASE.TCL
source SPLWF_F_CASE.TCL
source OUBI_LDRF_CASE.TCL
```

The order that the TCL files are loaded is important, as the objects are dependent on other objects. If an object is deleted from Oracle Warehouse Builder by running a TCL file, then references to that object are dropped from already existing Oracle Warehouse Builder objects. So

in all the cases, the order that the TCL files are listed in the preceding section is always used. Also, if an earlier object is recreated, all of the other objects that are listed afterwards also need to be created.

For example, if a change needs to be made to an Oracle Warehouse Builder mapping, the `owb_map_name.TCL`, `owb_wf_name.TCL` and `OUBI_LDRF_wf_name.TCL` (for facts) scripts are regenerated and reloaded into OMBPlus.

After loading some of these TCL scripts, the customizations that are done prior to earlier deployments are lost, so the preconditions to deployment must be redone. The following is a list of the scripts that you must rerun after changes are made:

- **EditFFCS.tcl:** This is needed to be run if the flat file TCL scripts (`stg_file_name.TCL` and `ctl_file_name.TCL`) are loaded.
- **EditFFLL.tcl:** This is needed to be run if the external table TCL scripts (`stg_tbl_name.TCL` and `ctl_tbl_name.TCL`) are loaded.
- **EDITFP.tcl and editmail.tcl:** These scripts is needed to be run if the process flow TCL scripts (`owb_wf_name.TCL`) are loaded.

Scheduling New Workflows

When new extracts are set up on the source application side and new Oracle Warehouse Builder process flows have been setup to load the new flat files, the File Processor daemon needs to be extended to allow the processing of the new flat files.

More specifically the parameters file needs to be extended to include the new mappings. In the new CM parameters file, these following two types of mapping need to be present:

- `extract.file.mapping.override.count`
- `extract.file.mapping`

Note: For more details on the File Processor daemon and the above mentioned parameters, refer to Chapter 4 under the section “**Scheduling Jobs Using the File Processor Daemon**”.

Oracle Warehouse Builder object deployment `Owbdeployment.sh` on the Unix platform (`Owbdeployment.cmd` on Windows platform) performs the following tasks:

- Imports the MDL files
- Configures Control Center
- Registers locations
- Runs TCL scripts to configure
- Deploys Oracle Warehouse Builder objects in following order:
 - Connectors
 - External Tables
 - Sequences
 - Dimensions
 - Transformations
 - Mappings
 - Workflows

Appendix K

Oracle Data Integrator ELT Components

Oracle Data Integrator ELT components include packages.

Packages

The following table lists out the entities populated using Oracle Data Integrator, and the Oracle Data Integrator package that is executed to perform the data load from replication to the target entity:

Product	Entity	Package name
CCB	B1_ARREARS_MON_MV1	B1_PKG_B1_ARREARS_MON_MV1
CCB	B1_ARREARS_MON_TOPX_MV1	B1_PKG_B1_ARREARS_MON_TOPX_MV1
CCB	B1_BILLEDUSAGE_MON_MV1	B1_PKG_B1_BILLEDUSAGE_MON_MV1
CCB	B1_BILLEDUSAGE_MON_TOPX_MV1	B1_PKG_B1_BILLEDUSAGE_MON_TOPX_MV1
CCB	B1_CASELOG_MON_MV1	B1_PKG_B1_CASELOG_MON_MV1
CCB	B1_CASE_MON_MV1	B1_PKG_B1_CASE_MON_MV1
CCB	B1_CASE_MON_MV2	B1_PKG_B1_CASE_MON_MV2
CCB	B1_CASE_TOPX_MON_MV1	B1_PKG_B1_CASE_TOPX_MON_MV1
CCB	B1_CASE_TOPX_MON_MV2	B1_PKG_B1_CASE_TOPX_MON_MV2
CCB	B1_CC_HOU_MV1	B1_PKG_B1_CC_HOU_MV1
CCB	B1_CC_MON_MV1	B1_PKG_B1_CC_MON_MV1
CCB	B1_CC_TOPX_MON_MV1	B1_PKG_B1_CC_TOPX_MON_MV1
CCB	B1_COLLPROC_MON_MV1	B1_PKG_B1_COLLPROC_MON_MV1

Product	Entity	Package name
CCB	B1_COLLPROC_MON_MV2	B1_PKG_B1_COLLPROC_MON_MV2
CCB	B1_COLLPROC_MON_TOPX_MV1	B1_PKG_B1_COLLPROC_MON_TOPX_MV1
CCB	B1_COLLPROC_MON_TOPX_MV2	B1_PKG_B1_COLLPROC_MON_TOPX_MV2
CCB	B1_FT_MON_MV1	B1_PKG_B1_FT_MON_MV1
CCB	B1_FT_MON_TOPX_MV1	B1_PKG_B1_FT_MON_TOPX_MV1
CCB	B1_PAY_PLAN_MON_MV1	B1_PKG_B1_PAY_PLAN_MON_MV1
CCB	B1_PAY_PLAN_SNAP_MON_MV1	B1_PKG_B1_PAY_PLAN_SNAP_MON_MV1
CCB	B1_PAY_PLAN_SNP_MON_TOPX_MV1	B1_PKG_B1_PAY_PLAN_SNP_MON_TOPX_MV1
CCB	B1_PA_MV1	B1_PKG_B1_PA_MV1
CCB	B1_PA_SNAP_MON_MV1	B1_PKG_B1_PA_SNAP_MON_MV1
CCB	B1_PA_SNAP_MON_TOPX_MV1	B1_PKG_B1_PA_SNAP_MON_TOPX_MV1
CCB	B1_SA_BILLING_MON_MV1	B1_PKG_B1_SA_BILLING_MON_MV1
CCB	B1_SA_BILLING_MON_TOPX_MV1	B1_PKG_B1_SA_BILLING_MON_TOPX_MV1
CCB	B1_SA_MON_MV1	B1_PKG_B1_SA_MON_MV1
CCB	B1_SA_MON_MV2	B1_PKG_B1_SA_MON_MV2
CCB	B1_SA_TOPX_MON_MV1	B1_PKG_B1_SA_TOPX_MON_MV1
CCB	B1_SA_TOPX_MON_MV2	B1_PKG_B1_SA_TOPX_MON_MV2
CCB	B1_TD_ENTRY_DOW_MV1	B1_PKG_B1_TD_ENTRY_DOW_MV1
CCB	B1_TD_ENTRY_DOW_MV2	B1_PKG_B1_TD_ENTRY_DOW_MV2
CCB	B1_TD_ENTRY_MON_TOPX_MV1	B1_PKG_B1_TD_ENTRY_MON_TOPX_MV1
CCB	B1_UCOLLPROC_MON_MV1	B1_PKG_B1_UCOLLPROC_MON_MV1
CCB	B1_UCOLLPROC_MON_MV2	B1_PKG_B1_UCOLLPROC_MON_MV2

Product	Entity	Package name
CCB	B1_UCOLLPROC_MON_TOPX_MV1	B1_PKG_B1_UCOLLPROC_MON_TOPX_MV1
CCB	B1_UCOLLPROC_MON_TOPX_MV2	B1_PKG_B1_UCOLLPROC_MON_TOPX_MV2
CCB	CD_ACCT	B1_PKG_CD_ACCT
CCB	CD_ADDR	B1_PKG_CD_ADDR
CCB	CD_ADJ_TYPE	B1_PKG_CD_ADJ_TYPE
CCB	CD_BILL_CAN_RSN	B1_PKG_CD_BILL_CAN_RSN
CCB	CD_BILL_CYC_SCH	B1_PKG_CD_BILL_CYC_SCH
CCB	CD_BILL_DAY_IN_WIN	B1_PKG_CD_BILL_DAY_IN_WIN
CCB	CD_BSEG_STATUS	B1_PKG_CD_BSEG_STATUS
CCB	CD_CAMPAIN	B1_PKG_CD_CAMPAIN
CCB	CD_CASETYPE_STATUS	B1_PKG_CD_CASETYPE_STATUS
CCB	CD_CASE_COND	B1_PKG_CD_CASE_COND
CCB	CD_CC_TYPE	B1_PKG_CD_CC_TYPE
CCB	CD_COLLEVT_TYPE	B1_PKG_CD_COLLEVT_TYPE
CCB	CD_COLLPROC_STATUS	B1_PKG_CD_COLLPROC_STATUS
CCB	CD_COLLPROC_TMPL	B1_PKG_CD_COLLPROC_TMPL
CCB	CD_DAYS_LAST_FRZ_BS	B1_PKG_CD_DAYS_LAST_FRZ_BS
CCB	CD_DAYS_TO_WIN_CLS	B1_PKG_CD_DAYS_TO_WIN_CLS
CCB	CD_DAYS_UNBILLED_USG	B1_PKG_CD_DAYS_UNBILLED_USG
CCB	CD_FISCAL_CAL	B1_PKG_CD_FISCAL_CAL
CCB	CD_FT_TYPE	B1_PKG_CD_FT_TYPE
CCB	CD_GL_ACCT	B1_PKG_CD_GL_ACCT
CCB	CD_INSTALLMENT_CNT	B1_PKG_CD_INSTALLMENT_CNT
CCB	CD_MSG	B1_PKG_CD_MSG
CCB	CD_MSRMT_TYPE	B1_PKG_CD_MSRMT_TYPE
CCB	CD_ORDER_CAN_RSN	B1_PKG_CD_ORDER_CAN_RSN
CCB	CD_ORDER_STATUS	B1_PKG_CD_ORDER_STATUS

Product	Entity	Package name
CCB	CD_PAY_CAN_RSN	B1_PKG_CD_PAY_CAN_RSN
CCB	CD_PAY_METHOD	B1_PKG_CD_PAY_METHOD
CCB	CD_PAY_PLAN_STATUS	B1_PKG_CD_PAY_PLAN_STATU S
CCB	CD_PAY_PLAN_TYPE	B1_PKG_CD_PAY_PLAN_TYPE
CCB	CD_PA_STATUS	B1_PKG_CD_PA_STATUS
CCB	CD_PER	B1_PKG_CD_PER
CCB	CD_PKG	B1_PKG_CD_PKG
CCB	CD_PREM	B1_PKG_CD_PREM
CCB	CD_RATE	B1_PKG_CD_RATE
CCB	CD_REC_CHARGE_AMOUNT	B1_PKG_CD_REC_CHARGE_AM OUNT
CCB	CD_SA	B1_PKG_CD_SA
CCB	CD_SA_STATUS	B1_PKG_CD_SA_STATUS
CCB	CD_SQI	B1_PKG_CD_SQI
CCB	CD_TD	B1_PKG_CD_TD
CCB	CD_TD_PRIORITY	B1_PKG_CD_TD_PRIORITY
CCB	CD_TD_ROLE	B1_PKG_CD_TD_ROLE
CCB	CD_TD_SKILL	B1_PKG_CD_TD_SKILL
CCB	CD_TD_STATUS	B1_PKG_CD_TD_STATUS
CCB	CD_TD_TYPE	B1_PKG_CD_TD_TYPE
CCB	CD_TNDR_SRCE	B1_PKG_CD_TNDR_SRCE
CCB	CD_TNDR_STATUS	B1_PKG_CD_TNDR_STATUS
CCB	CD_TNDR_TYPE	B1_PKG_CD_TNDR_TYPE
CCB	CD_TOU	B1_PKG_CD_TOU
CCB	CD_UCOLEVT_TYPE	B1_PKG_CD_UCOLEVT_TYPE
CCB	CD_UCOLPROC_STATUS	B1_PKG_CD_UCOLPROC_STAT US
CCB	CD_UCOLPROC_TMPL	B1_PKG_CD_UCOLPROC_TMPL
CCB	CD_UOM	B1_PKG_CD_UOM
CCB	CD_USER	B1_PKG_CD_USER
CCB	CF_ARREARS	B1_PKG_CF_ARREARS
CCB	CF_BILLED_USAGE	B1_PKG_CF_BILLED_USAGE
CCB	CF_CASE	B1_PKG_CF_CASE

Product	Entity	Package name
CCB	CF_CASE_LOG	B1_PKG_CF_CASE_LOG
CCB	CF_CC	B1_PKG_CF_CC
CCB	CF_COLL_EVT	B1_PKG_CF_COLL_EVT
CCB	CF_COLL_PROC	B1_PKG_CF_COLL_PROC
CCB	CF_FT	B1_PKG_CF_FT
CCB	CF_FT_GL	B1_PKG_CF_FT_GL
CCB	CF_ORDER	B1_PKG_CF_ORDER
CCB	CF_PA	B1_PKG_CF_PA
CCB	CF_PAY_PLAN	B1_PKG_CF_PAY_PLAN
CCB	CF_PAY_PLAN_SNAP	B1_PKG_CF_PAY_PLAN_SNAP
CCB	CF_PAY_TNDR	B1_PKG_CF_PAY_TNDR
CCB	CF_PA_SNAP	B1_PKG_CF_PA_SNAP
CCB	CF_RECENT_TD_ENTRY	B1_PKG_CF_RECENT_TD_ENTRY
CCB	CF_SA	B1_PKG_CF_SA
CCB	CF_SA_BILLING	B1_PKG_CF_SA_BILLING
CCB	CF_TD_ENTRY	B1_PKG_CF_TD_ENTRY
CCB	CF_UCOL_EVT	B1_PKG_CF_UCOL_EVT
CCB	CF_UCOL_PROC	B1_PKG_CF_UCOL_PROC
ODM	B1_ASSET_LOC_MON_MV1	B1_PKG_B1_ASSET_LOC_MON_MV1
ODM	B1_OPR_DEVICE_MON_MV1	B1_PKG_B1_OPR_DEVICE_MON_MV1
ODM	B1_OPR_DEVICE_MON_TOPX_MV1	B1_PKG_B1_OPR_DEVICE_MON_TOPX_MV1
ODM	B1_OPR_DEVICE_SNAP_MON_MV1	B1_PKG_B1_OPR_DEVICE_SNAP_MON_MV1
ODM	B1_OPR_DEVICE_SNP_MON_TOPX_MV1	B1_PKG_B1_OPR_DEVICE_SNP_MON_TOPX_MV1
ODM	B1_SERVICE_HIST_MON_MV1	B1_PKG_B1_SERVICE_HIST_MON_MV1
ODM	CD_ADDR	B1_PKG_CD_ADDR
ODM	CD_ASSET_AGE	B1_PKG_CD_ASSET_AGE
ODM	CD_ASSET_DISP	B1_PKG_CD_ASSET_DISP
ODM	CD_ASSET_INSP_STATUS	B1_PKG_CD_ASSET_INSP_STATUS

Product	Entity	Package name
ODM	CD_ASSET_INSTALL_AGE	B1_PKG_CD_ASSET_INSTALL_A GE
ODM	CD_ASSET_INSTORE_AGE	B1_PKG_CD_ASSET_INSTORE_ AGE
ODM	CD_LOCATION	B1_PKG_CD_LOCATION
ODM	CD_OPR_DEVICE	B1_PKG_CD_OPR_DEVICE
ODM	CD_SERVICE_HIST_TYPE	B1_PKG_CD_SERVICE_HIST_TY PE
ODM	CD_UTIL_ASSET	B1_PKG_CD_UTIL_ASSET
ODM	CF_ASSET_LOC	B1_PKG_CF_ASSET_LOC
ODM	CF_OPR_DEVICE	B1_PKG_CF_OPR_DEVICE
ODM	CF_OPR_DEVICE_SNAP	B1_PKG_CF_OPR_DEVICE_SNA P
ODM	CF_SERVICE_HIST	B1_PKG_CF_SERVICE_HIST

Appendix L

Terminology

The following Oracle Utilities Analytics terminologies are explained in detail in this chapter:

Data Source Indicator

The data warehouse is an integrated database receiving data from multiple sources applications. The Data Source Indicator (DSI) in Oracle Utilities Analytics is used as an identifier for the originating source application or system-of-record for the data. Both fact and dimension tables have a DSI value for each record.

In the edge applications integrated with Oracle Utilities Analytics, namely Oracle Utilities Customer Care and Billing, Oracle Utilities Meter Date Management, Oracle Utilities Mobile Workforce Management, Oracle Utilities Network Management System, and Oracle Utilities Work and Asset Management, the DSI value is defaulted from environment ID. In case of multiple instances of the same application loading the data in the data warehouse, e.g. two separate instances of Customer Care and Billing (CC&B) application, both the instances have different DSI value.

The DSI value is also used for data lookup when loading the fact data. The confirmed dimension like address may have data populated from multiple source applications, e.g. Oracle Utilities Customer Care and Billing and Oracle Utilities Meter Date Management, or may have data populated from multiple instances of same source application, e.g. two instances of Oracle Utilities Meter Date Management. It is also possible that two records, one from Oracle Utilities Meter Date Management, and another from Oracle Utilities Customer Care and Billing (or second instance of Oracle Utilities Meter Date Management), may have the same ID in source application. Therefore, while loading the fact record, DSI value is also included in dimension record lookup columns along with the source ID column(s) so that the fact record from a given source application is correctly linked to the dimension record from the same instance of the source application.

Late Arriving Dimension

Late arriving dimensions are the dimensions where the fact (measurable quantities) table records come early when compared to the dimension table records. An auto correction mechanism is implemented into the fact load process to handle such scenarios.

To support auto correction of late arriving dimensions, there are two default rows in each dimension.

Primary Key	Default Values	Data Source Indicator	Remark
0	***	NULL	This is used to refer to the Null value references in the source. Possibly valid reasons for the references to be Null.
-99	-N/A	NULL	This is be used to tag any unidentifiable references. The source data has a value for a reference, but corresponding record does not exist in the target. Possibly caused by late arriving dimensions.

Referencing Foreign Keys

The foreign key value is set to 0 for any rows with Null values for “Ref Natural Key”. The foreign key value is set to -99 for any rows with some value for “Ref Natural Key”, but no corresponding record in the dimension. Error reprocessing automatically binds these rows with the correct rows in the dimension, assuming that the dimension value has arrived.

Oracle Data Integrator

Context

A context is a collection of logical schemas mapped to physical schemas. All logical schemas may not be mapped to physical schemas in a context. The source, journal and replication schemas are not associated for the default Global context as this context is not associated with any source instance.

A context identifies the physical schemas and connections that are utilized for data access. Interfaces can be executed in any context as this allows reusing the same code for multiple instances.

The contexts are created while a source instance is configured for integration with Oracle Utilities Business Intelligence. The context code is a composite string comprising of the product code and the instance number. This combination allows us to create uniquely identifiable context codes associated with independent source systems.

Logical Schema

A logical schema is a logical representation of a storage location. The same physical schemas can be associated with different logical schemas. Here are some examples of schemas:

- **Source:** This is associated with the source instance.
- **Journal:** The journal schema is utilized for non-GoldenGate based replication. This represents the work schema where objects can be created for processing.
- **Replication:** This represents the data area where replicated data is stored. Each source system is associated with a replication schema on the target database.
- **Target:** All star schema objects are stored in this area.

-
- **Metadata:** The metadata configurations utilized to manage the solution are stored in this data area.
 - **Master:** The Oracle Data Integrator master repository is maintained in a separate schema associated with the master logical schema.
 - **Repository:** This schema is used to store the work repository of Oracle Data Integrator.
 - **Configuration:** The configuration schema is associated with the file store location used for export or import of the metadata.

Physical Schema

A physical schema is the actual schema or database user where data is retrieved or stored.

Model

A model is an Oracle Data Integrator entity, which stores the list of objects, their structures, constraints and relationships. The model also allows creation of validation rules that can be applied on the data.

The model folders in the solution are organized based on the logical schemas, which also form the different stages of data in the data processing pipeline.

The source models are not part of the base Oracle Data Integrator work repository that is installed in a fresh install. As each source instance is added the associated source model(s) are created and actions executed on it. Each source instance may have one or more models associated. The model codes are by suffixing two character alphabets to the context code.

Interface

An interface is a declarative mapping between the source to target, and it utilizes Loading Knowledge Modules (LKM), Integration Knowledge Module (IKM) and Check Knowledge Module (CKM) as required for execution. Joins, Aggregations, filters and data transformations are performed on an interface.

Package

A Package is made up of a sequence of steps organized into an execution diagram.

Agent

An agent is a component that executes the Oracle Data Integrator jobs. Multiple agents can be created and utilized for load balancing. The solution uses WebLogic enterprise agents for stability and scalability.

Reverse Engineer

Reverse engineering is the process of identifying the data structures, constraints and relations from an existing data store. The data store can be any database management system, files or any other Oracle Data Integrator supported data store.

Journalization

Journalization is the process of keeping track of data changes enabling incremental data access, transport and transformation.

Change Data Capture

Change data capture is the process of identifying and tracking data that has changed since the last known state. Change data capture mechanisms are implemented by the journalizing knowledge module.

Scenario

A scenario is a self contained prepackaged executable version of a package, interface or procedure in Oracle Data Integrator. The logic within the scenario cannot be viewed using the Oracle Data Integrator client.

Knowledge Module

Knowledge modules (KMs) in Oracle Data Integrator are components that implement reusable transformation and ELT (Extract, Load, and Transform) strategies across different technologies.

Knowledge Modules (KMs) are code templates. Each KM is dedicated to an individual task in the overall data integration process.

These are based on logical tasks that will be performed and do not contain references to physical objects (data stores, columns, physical paths, etc.).

A KM is reused across several interfaces or models. The benefit of knowledge modules is that you make a change once and it is instantly propagated to hundreds of transformations.

These can be written with a mix and match of different programming languages, types, and styles (native RDBMS SQL, scripting languages such as Jython or JavaScript, or even Java).

Types of knowledge modules are as follows:

- Reverse-engineering Knowledge Module (RKM)
- Check Knowledge Module (CKM)
- Loading Knowledge Module (LKM)
- Integration Knowledge Module (IKM)
- Journalizing Knowledge Module (JKM)
- Service Knowledge Module (SKM)

Note: Refer to Oracle Data Integrator documents for more details.