

**Oracle® Financial Services Analytical Applications
Infrastructure (OFSAI)**

Installation and Configuration Guide

Release 7.1

Part No. E16678-01

December 2010

Oracle Financial Services Analytical Applications Infrastructure (OFSAAI) Installation and Configuration Guide, Release 7.1

Part No. E16678-01

Copyright © 2010, Oracle and/or its affiliates. All rights reserved.

Primary Author: Surag Ramachandran, Anuradha Muralidharan

Contributor: Susan Bernstein, Rusma Harvey, Chris Tanaka

Oracle is a registered trademark of Oracle Corporation and/or its affiliates. Other names may be trademarks of their respective owners.

This software and related documentation are provided under a license agreement containing restrictions on use and disclosure and are protected by intellectual property laws. Except as expressly permitted in your license agreement or allowed by law, you may not use, copy, reproduce, translate, broadcast, modify, license, transmit, distribute, exhibit, perform, publish or display any part, in any form, or by any means. Reverse engineering, disassembly, or decompilation of this software, unless required by law for interoperability, is prohibited.

The information contained herein is subject to change without notice and is not warranted to be error-free. If you find any errors, please report them to us in writing.

If this software or related documentation is delivered to the U.S. Government or anyone licensing it on behalf of the U.S. Government, the following notice is applicable:

U.S. GOVERNMENT RIGHTS

Programs, software, databases, and related documentation and technical data delivered to U.S. Government customers are "commercial computer software" or "commercial technical data" pursuant to the applicable Federal Acquisition Regulation and agency-specific supplemental regulations. As such, the use, duplication, disclosure, modification, and adaptation shall be subject to the restrictions and license terms set forth in the applicable Government contract, and, to the extent applicable by the terms of the Government contract, the additional rights set forth in FAR 52.227-19, Commercial Computer Software License (December 2007). Oracle USA, Inc., 500 Oracle Parkway, Redwood City, CA 94065.

This software is developed for general use in a variety of information management applications. It is not developed or intended for use in any inherently dangerous applications, including applications which may create a risk of personal injury. If you use this software in dangerous applications, then you shall be responsible to take all appropriate fail-safe, backup, redundancy and other measures to ensure the safe use of this software. Oracle Corporation and its affiliates disclaim any liability for any damages caused by use of this software in dangerous applications.

This software and documentation may provide access to or information on content, products and services from third parties. Oracle Corporation and its affiliates are not responsible for and expressly disclaim all warranties of any kind with respect to third party content, products and services. Oracle Corporation and its affiliates will not be responsible for any loss, costs, or damages incurred due to your access to or use of third party content, products or services.

Contents

Send Us Your Comments

Preface

1 About this Manual

Introduction.....	1-1
Scope.....	1-1
Organization of the Manual.....	1-1

2 Pre-Installation Activities

Introduction.....	2-1
Environment.....	2-1
Control Panel Settings.....	2-1
Infrastructure Architecture.....	2-1

3 Infrastructure Installation Options

Introduction.....	3-1
Single-Tier Installation.....	3-1
Single Tier Installation with Database Engine on Remote Machine.....	3-1
Single Tier Installation with Web Server on Remote Machine	3-2
Multi-Tier Installation.....	3-2
Multi-Tier Installation-Option I.....	3-2
Multi-Tier Installation-Option II.....	3-3
Multi-Tier Installation-Option III.....	3-3
Multi-Tier Installation-Option IV.....	3-3
Distributed Infrastructure Application Server.....	3-4

4	Pre-Installation Infrastructure Activities Checklist	
	Introduction.....	4-1
5	WebSphere Configuration for Infrastructure Application Deployment	
	WebSphere Configuration.....	5-1
	Creation of New Profile in WebSphere.....	5-1
	Deletion of WebSphere Profiles.....	5-18
6	WebLogic Configuration for Infrastructure Application Deployment	
	WebLogic Configuration.....	6-1
	Creation of New Domain in WebLogic	6-1
	Deletion of a Domain in WebLogic	6-11
7	Installing Infrastructure	
	Installation Process.....	7-1
	GUI Installation.....	7-2
	Pre Configured Installation.....	7-26
8	Installing Secondary Application Server	
	Introduction.....	8-1
	Procedure.....	8-1
9	Configuring the Servlet Engine	
	WebSphere Configuration.....	9-1
	WebSphere Enterprise ARchive Files Creation.....	9-1
	WebSphere EAR Files Deployment.....	9-2
	Tomcat Configuration.....	9-9
	WebLogic Configuration.....	9-15
	WebLogic EAR Files Creation.....	9-15
	WebLogic EAR Files Deployment.....	9-16
10	Post Infrastructure Installation Activities	
	Introduction.....	10-1
	Configuring the libcpptripledes.so File.....	10-1
	Infrastructure Server Memory Configuration.....	10-1
	Configuring XVFB.....	10-2
	OLAP Data Server Configuration.....	10-2

Configuration for User Attributes Screen	10-3
Configuration of Infrastructure Ports.....	10-4
Web Server Port Change.....	10-6
Metadata Migration.....	10-7
Infrastructure Configuration for LDAP.....	10-8
IE Settings.....	10-12
SFTP and FTP Configuration.....	10-15
11 Starting Infrastructure	
Introduction.....	11-1
Starting the Infrastructure Server	11-1
Starting Websphere profile.....	11-2
Starting the Tomcat Application	11-2
Starting WebLogic profile.....	11-2
Starting the Information Command Center (ICC) Server	11-2
Starting the Agent Server	11-3
Starting the Infrastructure Server Administrative Console	11-3
Starting the LDAP Server.....	11-3
Logging into Oracle Financial Services Analytical Applications	11-3
12 System Configuration	
Introduction.....	12-1
Configuring Server Details.....	12-1
13 Configuring Database Server Details	
To configure database server.....	13-1
Configuring Database Server Details.....	13-2
Defining Server Details	13-4
14 Configuring Details	
Configuring Application Server Details.....	14-1
Configuring Web Server Details.....	14-2
Configuring Database Details.....	14-7
Adding Database Server Details for DB Server.....	14-14
Configuring an Information Domain.....	14-18
Configuring Password changes.....	14-29
15 Resource Reference Configuration	
Configuration of Resource Reference in Infrastructure Application.....	15-1

Configuration of Resource Reference in Websphere Application Server.....	15-1
Creating the Data Source in Websphere Application Server	15-5
Configuration of Resource Reference in Tomcat Application Server.....	15-12
Creating the Data Source in Tomcat Application Server.....	15-12
Creating the Data Source in WebLogic Application Server.....	15-13
16 Uninstalling Infrastructure Components	
Introduction.....	16-1
Uninstalling Previously Deployed EAR Files.....	16-2
17 Pre-Installation Applications Activities Checklist	
Pre-Installation Applications Activities Checklist	17-1
18 Applications Installation	
Introduction.....	18-1
Machine A – Product App Layer.....	18-2
Machine B – Product Database Layer.....	18-10
Machine C – Product Web Layer.....	18-18
19 Post Application Installation Activities	
Post Application Installation Checklist.....	19-1
Annexure.....	19-4
20 Configuration of OFSAAI	
Configuration for Model Upload Utility.....	20-1
Configuration for Dimension and Hierarchy Management.....	20-4
21 Frequently Asked Questions	
Introduction.....	21-1
OFSAAI Installation FAQ's.....	21-2
OFSAAI Configuration FAQ's	21-4
A Defining Application Sources	
Introduction.....	A-1
Creating an Application Source.....	A-1

Send Us Your Comments

Oracle Financial Services Analytical Applications Infrastructure (OFSAAI) Installation and Configuration Guide, Release 7.1

Part No. E16678-01

Oracle welcomes customers' comments and suggestions on the quality and usefulness of this document. Your feedback is important, and helps us to best meet your needs as a user of our products. For example:

- Are the implementation steps correct and complete?
- Did you understand the context of the procedures?
- Did you find any errors in the information?
- Does the structure of the information help you with your tasks?
- Do you need different information or graphics? If so, where, and in what format?
- Are the examples correct? Do you need more examples?

If you find any errors or have any other suggestions for improvement, then please tell us your name, the name of the company who has licensed our products, the title and part number of the documentation and the chapter, section, and page number (if available).

Note: Before sending us your comments, you might like to check that you have the latest version of the document and if any concerns are already addressed. To do this, access the new Oracle E-Business Suite Release Online Documentation CD available on My Oracle Support and www.oracle.com. It contains the most current Documentation Library plus all documents revised or released recently.

Send your comments to us using the electronic mail address: appsdoc_us@oracle.com

Please give your name, address, electronic mail address, and telephone number (optional).

If you need assistance with Oracle software, then please contact your support representative or Oracle Support Services.

If you require training or instruction in using Oracle software, then please contact your Oracle local office and inquire about our Oracle University offerings. A list of Oracle offices is available on our Web site at www.oracle.com.

Preface

Intended Audience

Welcome to Release 7.1 of the *Oracle Financial Services Analytical Applications Infrastructure (OFSAAI) Installation and Configuration Guide*.

This guide is meant for use by the OFSAInfrastructure Application System Administrator. It provides step-by-step instructions necessary for installing this application.

See Related Information Sources on page x for more Oracle E-Business Suite product information.

Deaf/Hard of Hearing Access to Oracle Support Services

To reach Oracle Support Services, use a telecommunications relay service (TRS) to call Oracle Support at 1.800.223.1711. An Oracle Support Services engineer will handle technical issues and provide customer support according to the Oracle service request process. Information about TRS is available at <http://www.fcc.gov/cgb/consumerfacts/trs.html>, and a list of phone numbers is available at <http://www.fcc.gov/cgb/dro/trsphonebk.html>.

Documentation Accessibility

Our goal is to make Oracle products, services, and supporting documentation accessible to all users, including users that are disabled. To that end, our documentation includes features that make information available to users of assistive technology. This documentation is available in HTML format, and contains markup to facilitate access by the disabled community. Accessibility standards will continue to evolve over time, and Oracle is actively engaged with other market-leading technology vendors to address technical obstacles so that our documentation can be accessible to all of our customers. For more information, visit the Oracle Accessibility Program Web site at

<http://www.oracle.com/accessibility/>.

Accessibility of Code Examples in Documentation

Screen readers may not always correctly read the code examples in this document. The conventions for writing code require that closing braces should appear on an otherwise empty line; however, some screen readers may not always read a line of text that consists solely of a bracket or brace.

Accessibility of Links to External Web Sites in Documentation

This documentation may contain links to Web sites of other companies or organizations that Oracle does not own or control. Oracle neither evaluates nor makes any representations regarding the accessibility of these Web sites.

Structure

- 1 About this Manual**
- 2 Pre-Installation Activities**
- 3 Infrastructure Installation Options**
- 4 Pre-Installation Infrastructure Activities Checklist**
- 5 WebSphere Configuration for Infrastructure Application Deployment**
- 6 WebLogic Configuration for Infrastructure Application Deployment**
- 7 Installing Infrastructure**
- 8 Installing Secondary Application Server**
- 9 Configuring the Servlet Engine**
- 10 Post Infrastructure Installation Activities**
- 11 Starting Infrastructure**
- 12 System Configuration**
- 13 Configuring Database Server Details**
- 14 Configuring Details**
- 15 Resource Reference Configuration**
- 16 Uninstalling Infrastructure Components**
- 17 Pre-Installation Applications Activities Checklist**
- 18 Applications Installation**
- 19 Post Application Installation Activities**
- 20 Configuration of OFSAAI**
- 21 Frequently Asked Questions**
- A Defining Application Sources**

Related Information Sources

Do Not Use Database Tools to Modify Oracle E-Business Suite Data

Oracle **STRONGLY RECOMMENDS** that you never use SQL*Plus, Oracle Data Browser, database triggers, or any other tool to modify Oracle E-Business Suite data

unless otherwise instructed.

Oracle provides powerful tools you can use to create, store, change, retrieve, and maintain information in an Oracle database. But if you use Oracle tools such as SQL*Plus to modify Oracle E-Business Suite data, you risk destroying the integrity of your data and you lose the ability to audit changes to your data.

Because Oracle E-Business Suite tables are interrelated, any change you make using an Oracle E-Business Suite form can update many tables at once. But when you modify Oracle E-Business Suite data using anything other than Oracle E-Business Suite, you may change a row in one table without making corresponding changes in related tables. If your tables get out of synchronization with each other, you risk retrieving erroneous information and you risk unpredictable results throughout Oracle E-Business Suite.

When you use Oracle E-Business Suite to modify your data, Oracle E-Business Suite automatically checks that your changes are valid. Oracle E-Business Suite also keeps track of who changes information. If you enter information into database tables using database tools, you may store invalid information. You also lose the ability to track who has changed your information because SQL*Plus and other database tools do not keep a record of changes.

About this Manual

Introduction

Oracle Financial Services Analytical Applications Infrastructure (OFSAAI) is a business intelligence application, developed by Oracle Financial Services Software Limited. It is a decision-support system that helps deliver information required for strategic, tactical, and operational decision making.

OFSAAI is a data management tool-set that is platform independent, and is designed to meet the needs of small, medium, and enterprise customers. It is also web-enabled and has an n-tiered architecture that provides the required security, scalability, and high availability.

Scope

Infrastructure architecture provides a choice of platforms to the end-user. The available options enable the end-user to choose the environment based on their preference, system performance and cost parameters.

This manual details the steps involved in installing OFSAAI in the released environment.

Organization of the Manual

The Installation Manual is organized into the following chapters.

Pre-Installation Activities section identifies the hardware and base software components that are required for a successful installation and functioning of the Infrastructure application. It also gives information on the Infrastructure Architecture.

Infrastructure Installation Options provides information on the two modes of Infrastructure Installation.

The *Pre-Installation Infrastructure Activities Checklist* outlines the pre-installation

activities that must be completed successfully prior to initiating the Infrastructure Installation Kit run.

WebSphere Configuration for Infrastructure Application Deployment outlines the steps required to create / delete a new profile in Websphere.

Installing Infrastructure section details the steps to be followed during the infrastructure installation.

Installing Secondary Application Server details the procedure to be followed for Secondary Application Server instance.

Configuring the Servlet Engine section outlines the steps required to create and deploy the EAR file in WebSphere and WAR file in Tomcat

Post Infrastructure Installation Activities section details the list of activities to be performed after the installation of the Infrastructure application.

Starting Infrastructure details the sequence and the process of starting this application.

System Configuration provides information on Configuring Server details.

Configuring Database Server Details outlines the procedure to be followed for configuring as well as defining the database server.

Configuring Details chapter provides details on configuring the application server, web server, database as well as on configuring the information domain. This chapter also provides the steps to be followed while adding database server details for DB server.

Resource Reference Configuration chapter provides information regarding Configuration of Resource Reference in Infrastructure Application, Websphere Application Server as well as Tomcat Application Server. This chapter also provides the steps to be followed for Creating the Data Source in Websphere Application Server as well as Tomcat Application Server.

Uninstalling Infrastructure Components section provides step by step instruction to uninstall the Oracle Financial Services Analytical Applications Infrastructure application.

Defining Application Sources chapter provides the steps to create an application source.

The *Pre-Installation Applications Activities Checklist* outlines the pre-installation activities that must be completed successfully prior to initiating the Application Installation Kit run.

Applications Installation chapter describes the installation process where the Three Product setup components are installed on separate machines with the Product installation on separate machines.

The *Post Application Installation Activities* chapter outlines the post-installation activities that must be performed once the installation of the Oracle Financial Services FTP, PFT and ALM Product is completed.

Configuration of OFSAAI chapter outlines the steps involved in Configuring for Model Upload Utility as well as Configuration for Dimension and Hierarchy Management.

Frequently Asked Questions chapter attempts to provide answers in resolving few of the OFSAAI Installation and configuration issues.

Since Infrastructure makes use of the Third Party Freeware, the license agreements for the same are attached in the concluding section of this manual.

Pre-Installation Activities

Introduction

The list of pre-requisite hardware and software required to install and run the OFSAAI application is stated in this section. The installation process requires certain environmental variables to be set prior to starting the installation. Ensure that these requirements are met before performing the installation. You are requested to refer to the Release Notes for any updates on hardware or software requirements.

Environment

Please refer to Support Note 1070591.1 at <https://support.oracle.com>, for information on technology components that are required to install Oracle Financial Service Analytics Infrastructure.

Control Panel Settings

The Infrastructure application is an internationalized application. Therefore, if the user requires the display of the application in the local language, the local settings need to be specified on the client machine. Contact your System Administrator for assistance in installing and configuring the language and regional settings.

Note: The availability of local language support is governed by the application license issued.

Infrastructure Architecture

The Infrastructure application is architected into 3 layers:

- The Application layer that hosts the application's business logic.

- The Database layer that hosts the application's back-end components.
- The Web layer that hosts the applications' General User Interface (GUI) components

Each layer installs its corresponding components. As mentioned earlier in the Hardware Environment section, the components can be installed on a single machine (referred to as the single-tier mode) or on multiple machines (referred to as the multi-tier mode).

Infrastructure Installation Options

Introduction

As explained in the earlier section, OFSAAI supports multiple deployment architectures. You must choose the architecture that best suits your business and technology needs. It is mandatory that you select the scenario (architecture) before proceeding with the installation.

There are two modes of Infrastructure Installation, Single Tier and Multi Tier.

Single-Tier Installation

You can install all the Infrastructure components – Application, Web and Database components –on a single machine. This option further warrants the Servlet Engine to be installed on the same machine.

Single Tier Installation with Database Engine on Remote Machine

You can also choose an option in the single tier architecture where the database engine is pointed to a remote machine. This particular architecture would be as follows:

- Infrastructure Application and Database components and Web components are installed on Machine A
- Database Engine is pointed to Machine B

Note: • Make sure that you have a TNS entry of Machine B in Machine A. In such cases, make sure that the database client of same version is installed in Machine A.

Single Tier Installation with Web Server on Remote Machine

You can also choose an option in the single tier architecture where the servlet engine is installed on a remote machine. This particular architecture would be as follows

- Infrastructure Application and Database components and Web components are installed on Machine A
- Infrastructure Web components are installed on Machine A for the creation of Infrastructure Application files (EAR\WAR files)
- Infrastructure Application files or EAR\WAR files are deployed on the Web server installed on Machine B
 - EAR/WAR files are the Infrastructure Deployed files.
 - The creation and deployment of EAR\ WAR files will have to be done manually. Refer to *WebSphere Configuration* section for instructions on *WebSphere EAR Files Creation and Deployment* and *Tomcat Configuration* section for instructions on Tomcat WAR Files Creation and Deployment..

Multi-Tier Installation

OFSAAI also supports multi-tier installation . Four installation options are described in this section. In each of the options, the assumption is that the servlet engine, Tomcat is installed on the same machine that will be used to install OFSAAI Web components.

In all the cases below where Multi Tier option is selected in the Infrastructure Installation Mode screen, the components (Application, Database or Web), that are being installed in the particular machine must be selected in the Choose Component(s) screen.

Multi-Tier Installation-Option I

You may choose to install the three components on separate machines with the servlet engine on the same machine identified as the infrastructure web server.

This particular architecture would be as follows:

- Infrastructure database components are installed in Machine A
- Infrastructure Application components are installed on Machine B
- Infrastructure web components are installed on Machine C

- Web server is installed in on Machine C

Multi-Tier Installation-Option II

You may choose to collapse the Infrastructure Database and Application layers into one machine and host the Infrastructure web layer along with the servlet engine on a separate machine.

This particular architecture would be as follows:

- Infrastructure database and application components are installed on Machine A
- Infrastructure web components are installed on Machine B
- Web server is installed on Machine B

Multi-Tier Installation-Option III

You can choose to host the Infrastructure database components on a separate machine and collapse the Infrastructure application and web layers along with the servlet engine onto a separate machine.

This particular architecture would be as follows:

- Infrastructure database components are installed on Machine A
- Infrastructure application and web components are installed on Machine B
- Web server is installed on Machine B

Multi-Tier Installation-Option IV

You can also choose to host the Infrastructure Application components on a separate machine and collapse the Infrastructure database and web components along with the servlet engine on a separate machine.

This particular architecture would be as follows:

- Infrastructure database and web components are installed on Machine A
 - Infrastructure application components are installed on Machine B
 - Web server is installed on Machine A
- For all multi-tier installation options stated, the Infrastructure database components must be installed first.

- In all multi tier installations, communication must be established between machines A and B either through IP addresses or hostnames.
- In all the above multi-tier options, you also have the provision to configure the database engine in a Remote machine. This requires a TNS entry of database engine machine in database components machine. In such cases, the machine that has the database components installed on it requires the database client of the same version to be also installed on it.
- In case of multi-tier installation, the tnsname and SID should be same in both the application and database layers.

Distributed Infrastructure Application Server

With the increase in data handled/managed by the Infrastructure server and its various services, it is increasingly becoming apparent that the server needs to be scaled out / distributed across different JVMs (machines). In earlier versions, the server did not have the functionality to distribute the various services. However, the current functionality allows the server for distributing the load based on different information domains. Each of this distributed Infrastructure Application Server known as Oracle Financial Services Analytical Applications Infrastructure application instance.

The main features of Infrastructure Application Instance are:

- Distribution based on both services and information domains.
- Availability of an Administrative Console to monitor the Servers which allows the user to decide the number of application server instances on which the instance needs to be distributed based on different services and information domains. Load balancing is achieved by the distribution of services.

The first Infrastructure application Instance would be termed as the Default Application Instance.

Pre-Installation Infrastructure Activities Checklist

Introduction

Before the OFSAAI installation Kit program is run, ensure that the pre-installation activities mentioned in the checklist below are completed successfully.

√	Tasks
General Configuration	<p>Ensure that the pre-requisite base software as outlined in the Software Environment chapter has been installed and administered on each machine.</p> <p>Make sure that you have approximately 1.4 GB hard disk space in your /tmp mount. This is required for Infrastructure installation and will be released once the installation is complete.</p> <p>Create a separate Unix user administrator account on the released environment machines on which Infrastructure components will be installed. Note that the shell prompt set for these user accounts should be korn shell. These user ids will be used to log on to the machines and initiate the installation process. By default, the home directory would have '755' UNIX permission. Make sure that these newly created user accounts also have '755' UNIX permission. This user should not be the same user used for Oracle database application installations.</p>

Ensure IBM XL V9 runtime compiler is installed on all the machines used for OFSAAI installation if this is on AIX. It can be downloaded from the following link

http://www-1.ibm.com/support/docview.wss?rs=2030&context=SSJT9L&uid=swg24015997&loc=en_US&cs=utf-8&lang=en

Download Package Name is `xlcpp.rte.9.0.0.aix.base.tar.Z`

Hummingbird Exceed 7.0 must be available on all the machines. This is required to run the Installation Kit.

On all machines in which Infrastructure components will be installed, the PATH variable in the user profile of the machines must point to Java Runtime installation. The machine on which the Infrastructure Web components are installed, the PATH variable in the user profile of the machine must point to Java Development Kit installation.

SMTP services must be running on any one of the machines. The machines need not be the ones identified for installation of Infrastructure components. This is required by the Rule Engine modules of Infrastructure. This configuration is optional.

The machines that will be used for the installation of Infrastructure components must be on the network and must be able to resolve each other's hostname. This is required in the event the installation is required to be performed using the hostnames instead of the IP addresses.

If multiple machines are used for the Infrastructure installation, the server date & time set at each machine must be the same. Different date-time settings on each machine will lead to improper functioning of the scheduler in the Infrastructure application.

For optimal performance in Application Server layer of OFSAAI, the RAM size must be around 20 times the size of the Erwin model.

The minimum space required for installing the Infrastructure components is given below. Make sure that the machines in which the Infrastructure components are installed have the following minimum required space.

- Infrastructure Application Layer - 113 MB
- Infrastructure Database Layer - 125 MB
- Infrastructure Web Components - 275 MB
- Infrastructure War file deployment in web layer - 270 MB
- Space used for Tomcat - 270MB

Note: Make sure that /tmp area has a minimum of 1200 MB space.

Oracle Database Configuration

The value of open database cursors need to be set to a minimum of 100
For example, ALTER SYSTEM SET OPEN_CURSORS=100

The Oracle Service and the Oracle TNS listener must be started on the machine which is designated as Infrastructure Database Server.

The Oracle SID that will be used by the application must be specified as an appropriate entry in tnsnames.ora.

In case of multi-tier installation, the tnsname and SID should be the same in both the Application and Database Layers.

The oracle instance must be created with the default NLS_NCHAR_CHARACTERSET as AL16UTF16.

The oracle instance must be created with the default NLS_LENGTH_SEMANTICS as BYTE

The oracle database alias name created for oracle instance and oracle service name should be the same.

It is essential to create a Config Schema user that will be used by Infrastructure with these set of privileges:

grant create session to <Config Schema user>

grant create view to <Config Schema user>

grant create sequence to <Config Schema user>

grant create table to <Config Schema user>

grant create procedure to <Config Schema user>

grant create any index to <Config Schema user>

grant create trigger to <Config Schema user>

The Config schema is the master schema that stores much of the Infrastructure metadata including security mapping and configuration. This Config Schema User will be required when entering the Oracle - Database details during Infrastructure installation.

A separate schema will need to be created for the application installation. This schema, referred to as the Atomic schema, will store all the data and metadata for the application(s) that are installed. Information domains or Infodoms are created within the Atomic schema and not the Config schema.

For more information on Infodoms, Config and Atomic schemas refer to Configuring Details, page 14-1.

On the machine which is designated to be the Infrastructure database server, ensure that the ORACLE_HOME is set pointing to the Oracle 11g installation path. This path should be included in the .profile file of the user installing the application.

Note for Linux platform installation:

ORACLE_HOME should be set to 32-bit Oracle 11g Client installation path. It is required to use the 32-bit Oracle Client libraries even for a 64-bit Linux server.

Make sure that the tnsname and SID are the same in both the Application and Database Layers.

Care should be taken to ensure that at least 512 MB temporary table space and at least 512 MB default table space of the oracle instance created are available in the machine in which Infrastructure Config schema will be installed.

Ensure that 10 MB quota is granted to the user on the default and temporary table space

If the Infrastructure database components and Infrastructure database server engine is designated on two different physical machines:

- Oracle client must be installed in the system where Infrastructure Database Components are being installed.
- The Oracle SID that will be used by the application must be specified as an appropriate entry in tnsnames.ora file in the system where Infrastructure Database Components are being installed and also in the system where Oracle Database Server Engine is installed.
- Make sure that the tnsname and SID are the same in both the Database Components Layer and Database Server Engine.

Ensure that you have the following Oracle details handy before you start the installation:

- Oracle connection string (SID) on the machine that hosts Oracle database.
- Port on which the Oracle service is running is available.
- Oracle Config schema username, password, default tablespace and temporary tablespace of the oracle instance on the machine that hosts the Oracle database.
- Oracle driver Path on the machine in which Infrastructure Database components will be installed.

In case of multi-tier installation of Infrastructure, where the Database server and Application Server are in different machines, the Application Server must have Oracle Database Client installed.

Locale Settings

The following locales must be installed on the machine in which Infrastructure Database components will be installed.

- en_US.UTF-8
- en_US.ISO8859-1

Tomcat related Prerequisites

Ensure that Tomcat is installed in directories where the directory names do not contain spaces. If the directory name contains spaces, then accessing the application may pose problems.

Uninstall any previously deployed applications hosted in Tomcat. This must be done prior to the start of the installation. (Refer: Uninstalling Previously Deployed WAR Files in the chapter Configuring the Servlet Engine in this manual for details).

Ensure that the Tomcat Server is not running.

The user ID that will be used to install the Infrastructure Web components must be given write permissions to the Tomcat installation directory.

Set the CATALINA_HOME environment variable to the Tomcat Installation directory.

You must have the following information about your Tomcat web server available and handy before you start the installation:

- The Tomcat Installation directory on the machine in which Infrastructure Web components will be installed.
- The path in which the Infrastructure Application files will be deployed in the machine that hosts Tomcat.

Example

Example: /home/revcat/apache-tomcat-5.5.17

WebLogic related
Prerequisites

- WebLogic Application Server should be up and running.
- A WebLogic Administration User ID having privileges to deploy an EAR file on the machine that hosts WebLogic must be created.

Have the following
information available
and handy before you
start the installation:

-
- Decide the architecture in which Infrastructure is to be deployed before you start the installation. The architecture options are briefly outlined in the Infrastructure Installation Options section.
 - Identify the machines on which Infrastructure Database, Application, and Web components will be installed.
 - The Infrastructure License Key and alphanumeric Customer Identification Number that has been made available to you..
 - The IP Addresses or Hostnames of the machine(s) in which Infrastructure components will be installed.
 - The Full path where Infrastructure will be installed in each of the machines.
 - The port number on which the servlet engine is running. (The default port for Websphere / Tomcat / Weblogic is 9080 / 8080 / 7001). If you use a port number that is different from the default value, you must configure the port immediately after the installation. Contact your WebSphere / Tomcat/ Weblogic Administrator for more information
 - If Infrastructure Application needs to be configured for HTTPS (SSL),
 - For Websphere the HTTPS port would be configured during Profile creation. Refer to WebSphere Configuration for Infrastructure Application Deployment section in this manual for more details. This needs to be given as the servlet port during Installation.
 - For Tomcat the HTTPS port would be configured in server.xml file under <Tomcat installed directory>/conf. Refer to section SSL Port Configuration in this manual for more details. This needs to be given as the servlet port during Installation.
 - If Oracle Infrastructure Application needs to be configured for HTTPS (SSL), note the HTTPS port that would be configured in Weblogic during Domain creation. This needs to given as the Servlet port during Installation.
 - The path in which the EAR/ WAR file would be deployed in Websphere / Tomcat
 - The java Home Path on all machines.
-

LDAP related Prerequisites

The following steps are required only if you are using LDAP authentication for logging on to Infrastructure:

- Make sure that OPEN LDAP 2.2.29+ is installed and configured.
- The LDAP server should be up and running.
- Keep the following information handy before beginning the installation:

LDAP Server URL

Root Context for the LDAP Directory

Root Designation for LDAP directory

Password for the LDAP Root

SFTP Configuration

For SFTP configuration, OpenSSH-4.3 software should be downloaded and installed in all the Infrastructure Server machines. You can download it from the following URL:
<http://www.openssh.com/openbsd.html>.

Configuration of Infrastructure Ports

The default ports that will be used on the machine in which Infrastructure Application components will be installed are as follows. Make sure that these ports are enabled on the machine before you start the installation.

- Infrastructure Server Java Port – 9999
- Infrastructure Server Native Port – 6666
- ICC Object Server Port – 6507
- ICC Native Server Port – 6509
- Servlet Port – 9080 (The default port for Websphere / Tomcat / Weblogic is 9080 / 8080 / 7001).

The default ports that will be used on the machine in which Infrastructure Database Components will be installed are as follows. Make sure that these ports are enabled on the machine before you start the installation.

- Agent Port – 6510
- Router Port - 6500
- Activation Manager Port - 6505
- Message Server Port - 6501
- Servlet Port should be enabled in the machine on which WebSphere / Tomcat / WebLogic is installed.

Note: The ports mentioned in the above two instances are the default ports. During the installation process, you are allowed to change the port numbers. If you are changing the port numbers, make sure that the ports are enabled on the machine.

The FTP Port (21) or SFTP Port (22) and protocol must be enabled on the machines on which Infrastructure Application and Database components will be installed.

Essbase
Configuration

-
- On the machines in which OFSAAI Database components installed, the HYPERION_HOME and ARBORPATH environment variables in the user profile must point to the location where Hyperion Essbase has been installed and Hyperion Essbase Client Directory respectively.

Example

```
HYPERION_HOME=/oracle/essbase
```

```
export HYPERION_HOME
```

```
ARBORPATH=/oracle/essbase/AnalyticServicesClient
```

```
export ARBORPATH
```

Make sure that the following library paths exist.

```
$ARBORPATH/api/lib
```

```
$ARBORPATH/bin
```

```
$HYPERION_HOME/common/ODBC/Merant/5.2/lib
```

Note: • Hyperion Essbase is required only if you are using the OLAP feature of OFSAAI

WebSphere related
Prerequisites

You must set the timeout value in the soap.client.props file in [WebSphere_Install_Directory>/AppServer/profiles/<profile name>/properties to zero.

Following configuration steps are required to process struts request on WebSphere.

These steps allow processing the struts filter.

- Log in to WebSphere Admin Console.
- Navigate to Application Servers- ><server>->WebContainer Settings ->Web Container->Custom Properties.
- Add the following property-

Property Name:

```
com.ibm.ws.webcontainer.invokefilterscompatibility
```

Value: true

WebSphere Configuration for Infrastructure Application Deployment

WebSphere Configuration

To enable deployment of multiple Infrastructure applications on a single WebSphere, one must create a stand-alone application server. However, you can use the Profile Creation wizard to create additional stand-alone application servers.

A profile is the set of files that define the runtime environment. At least one profile must exist to run WebSphere Application Server. You can create profiles through the Profile Management Tool in WebSphere.

The Profile Management Tool can create an application server profile on the machine where WebSphere application exists.

Creation of New Profile in WebSphere

- Navigate to the <WebSphere_Installation_Directory>/AppServer/bin/Profile Management directory. Execute pmt.sh. The Profile Management Tool screen is displayed. This wizard will take you through the profile creation process.

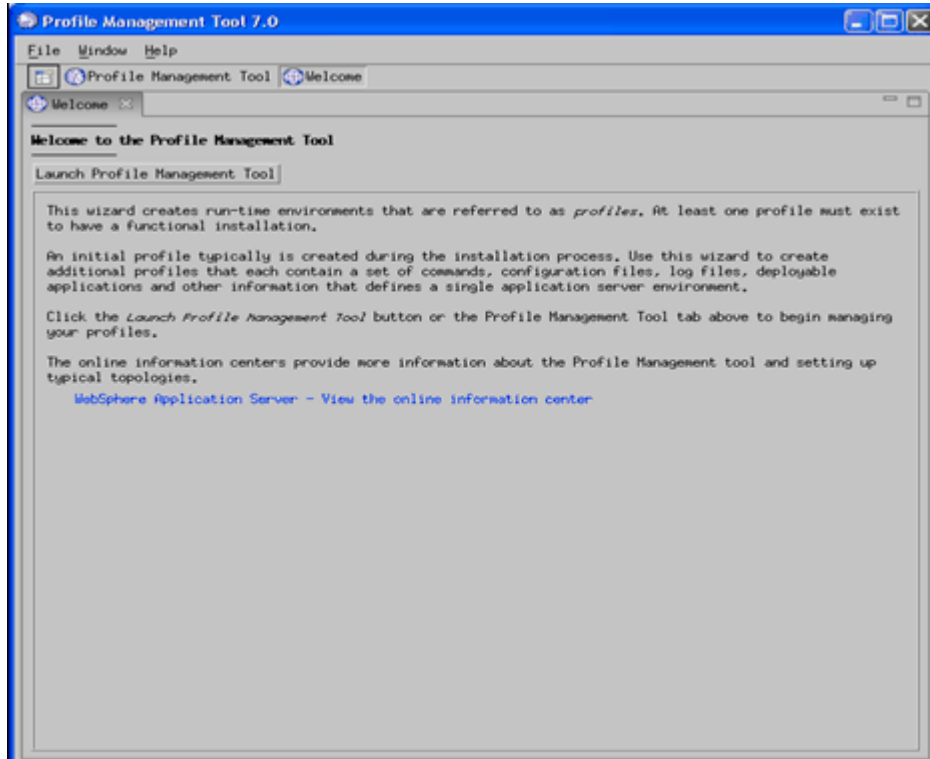

- Click on Launch Profile Management Tool. Environment Selection screen of the Profile Creation Wizard is displayed. Select the type of WebSphere Application Server environment to create from the displayed environments and click Next to continue.

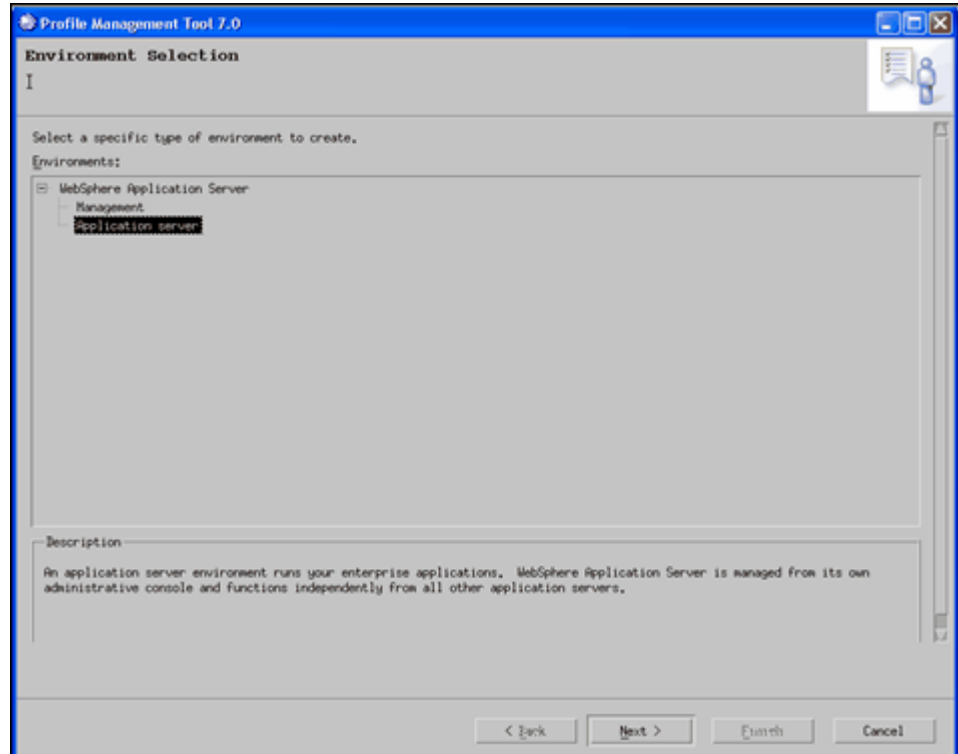

- The Profile Creation Options window is displayed. Choose Typical profile creation to create a profile having default properties and features. If you wish to customize the features, choose Advanced profile creation
Click Next to continue.

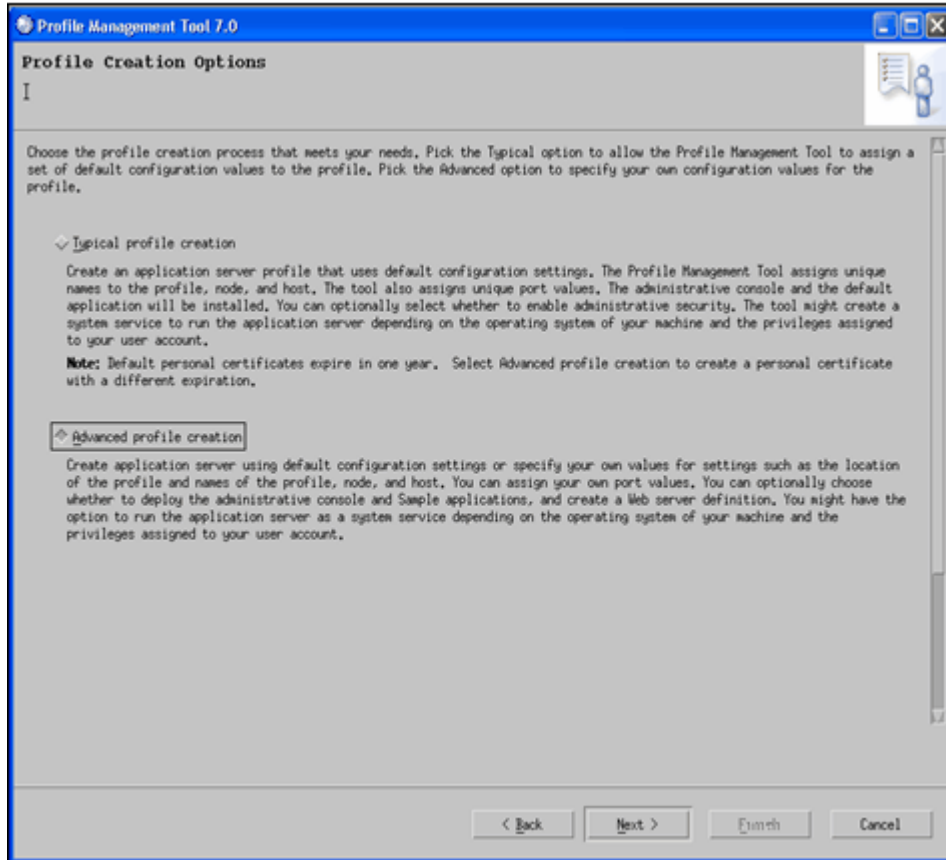

- The Optional Application Deployment screen is displayed. Select Deploy the administrative console and Deploy the default application check boxes and click Next to continue.

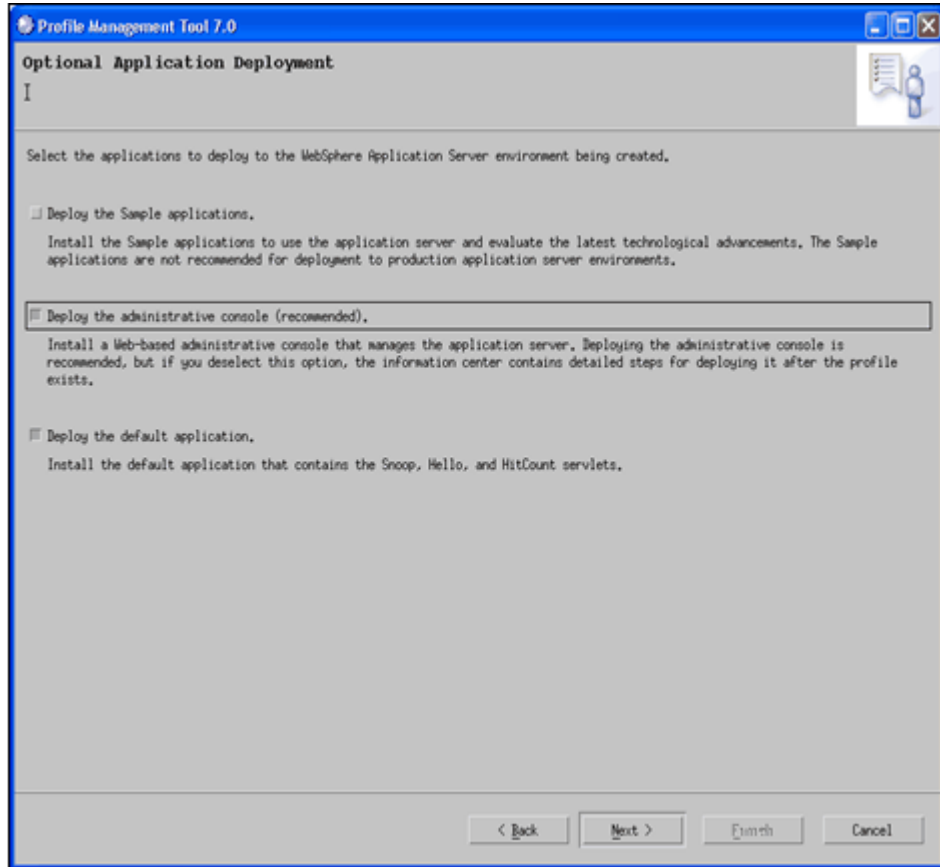

- The Profile Name and Location screen is displayed. Enter the Profile name and Profile directory in the respective fields and click Next to continue.

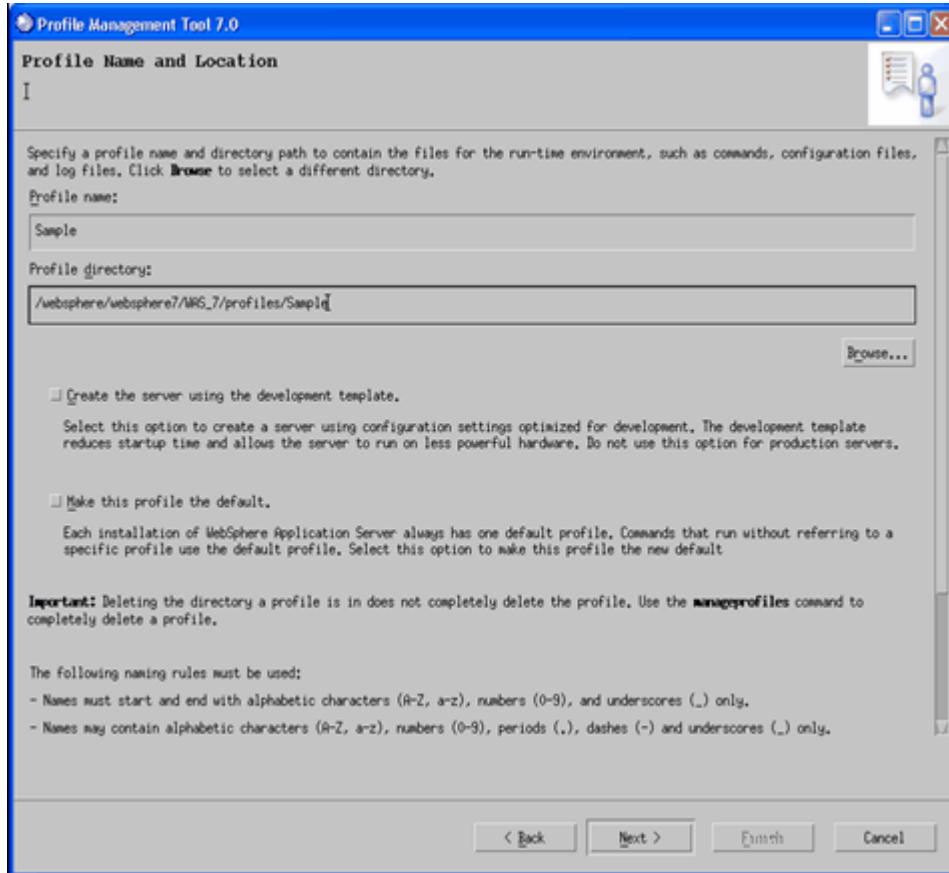

- The Node and Host Names window is displayed. The default values for Node and Host name will be displayed in the respective fields. Click Next to continue.

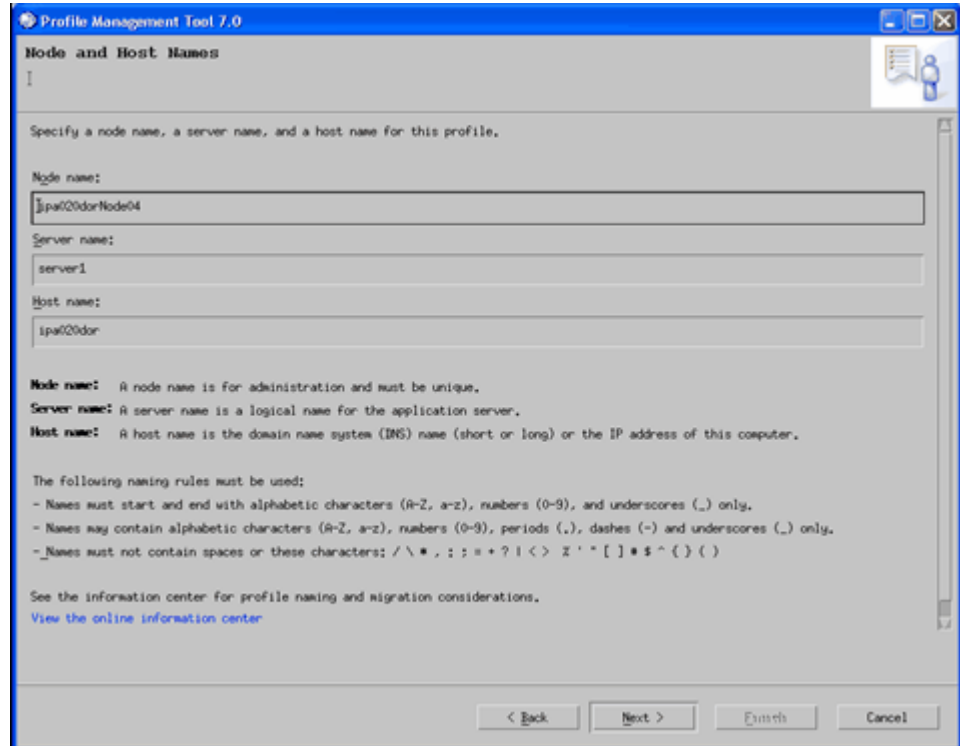

- The Administrative Security screen is displayed. Enable the administrative security, if required, by selecting the check box and providing User name and password in the respective fields. Click Next to continue.

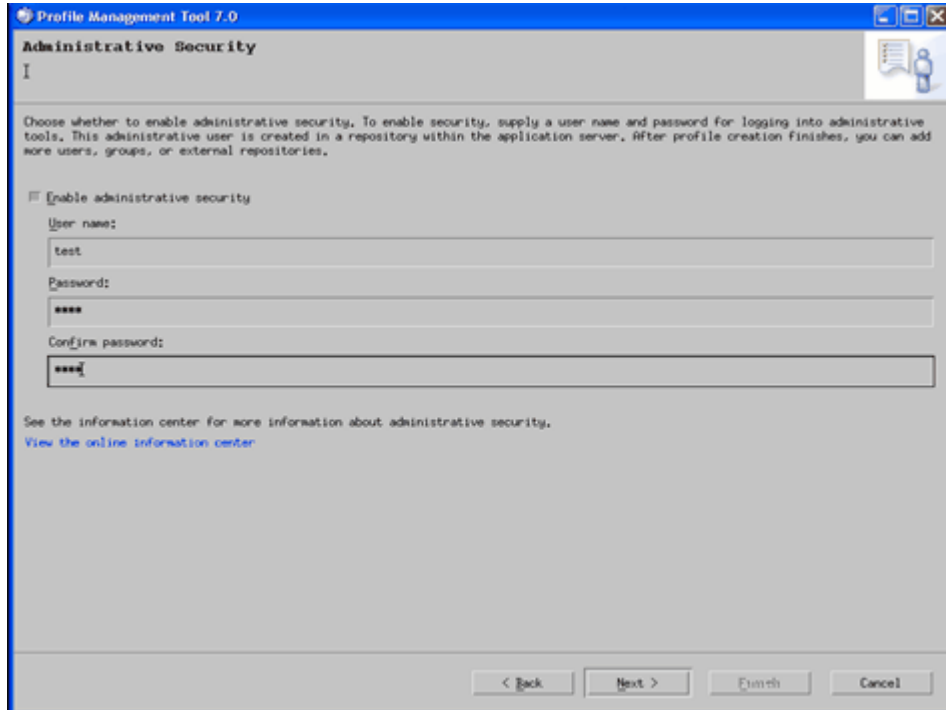

- The Security Certificate screen (part 1) is displayed. Select 'Create a new default personal certificate' and create a new root signing certificate'. Click 'Next'.

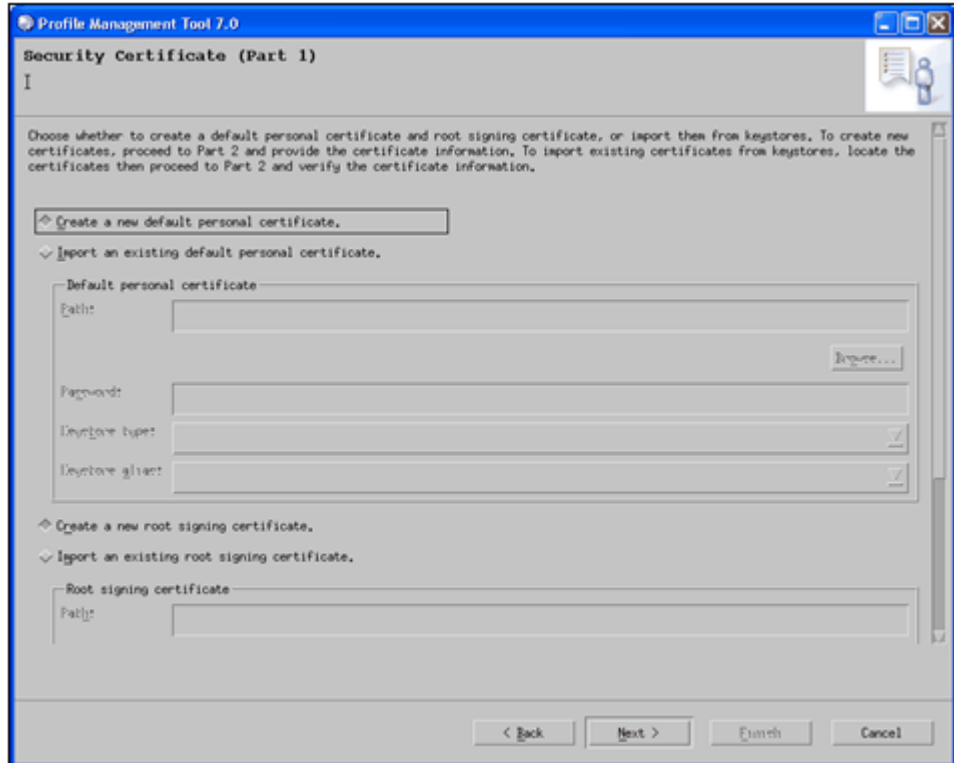

- The Security Certificate screen (part 2) is displayed. Provide password for default keystore. Click 'Next'.

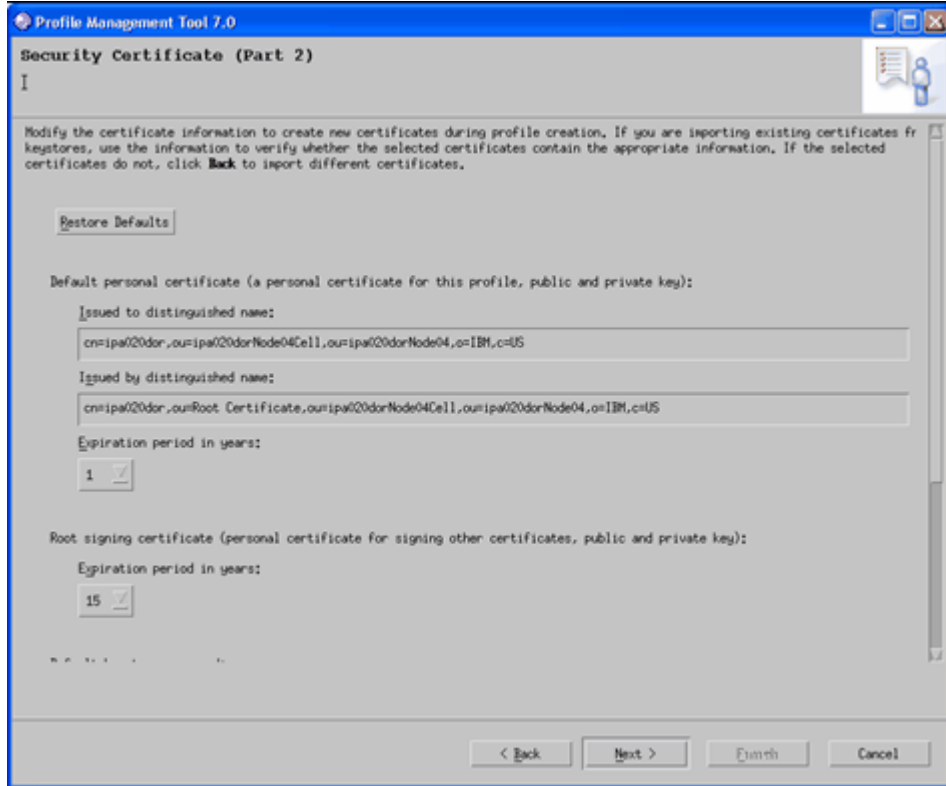

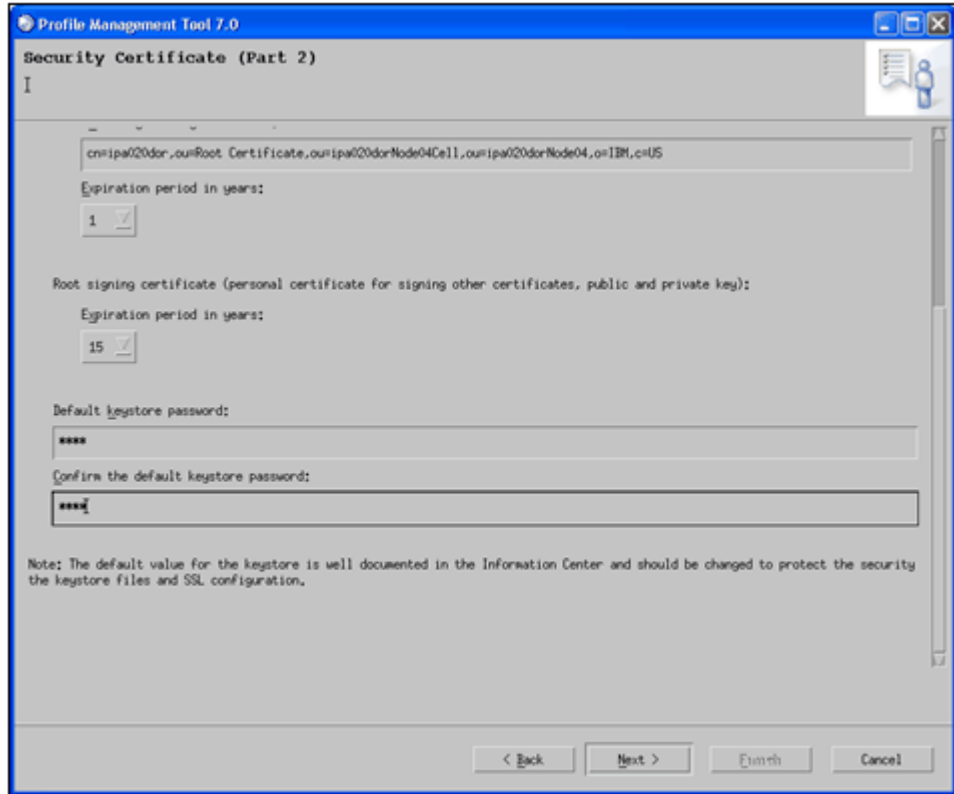

- The Port Values Assignment screen is displayed. Click the Recommended Port Values button to populate the fields with the recommended port values. This will also help in avoiding run-time port conflicts as each port value should be unique and should not conflict with other profiles in this installation. Click Next.

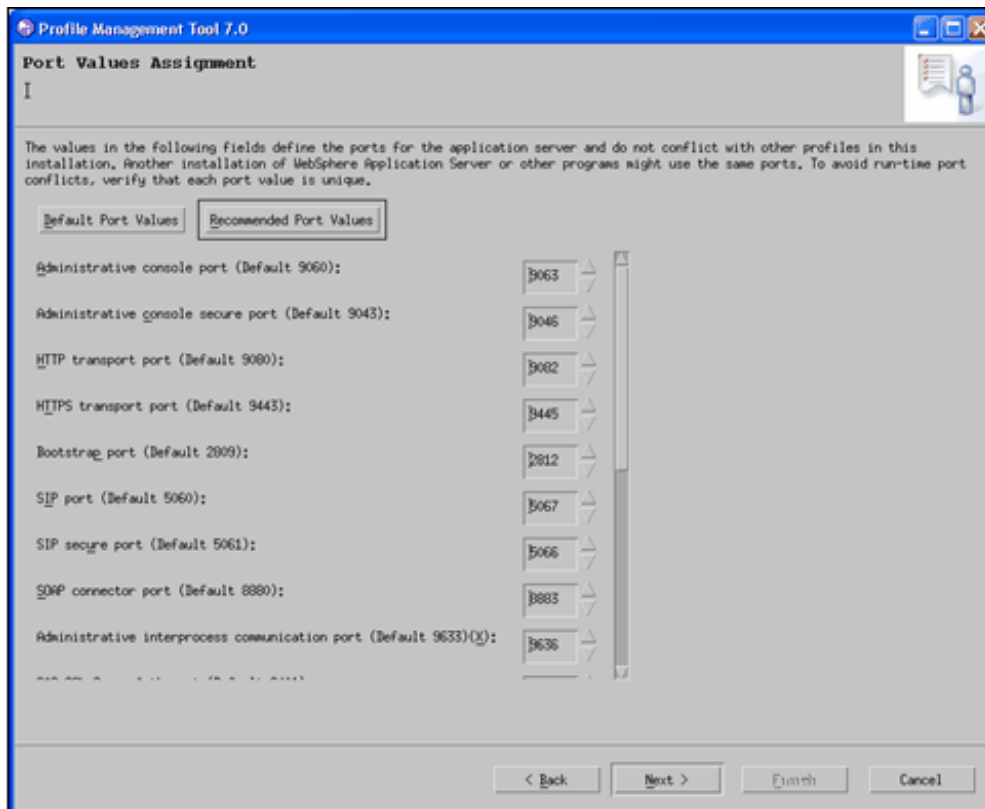

Note: These port values will be stored in <WebSphere Profile Directory>/config/cells/<NodeCell>/nodes/<Node Name>/Serverindex.xml

- The Web Server Definition screen is displayed. Select the Create a web server definition check box if you want to create a customized web server definition. If the check box is selected, the fields below it become active. Enter the required information and click Next to continue.

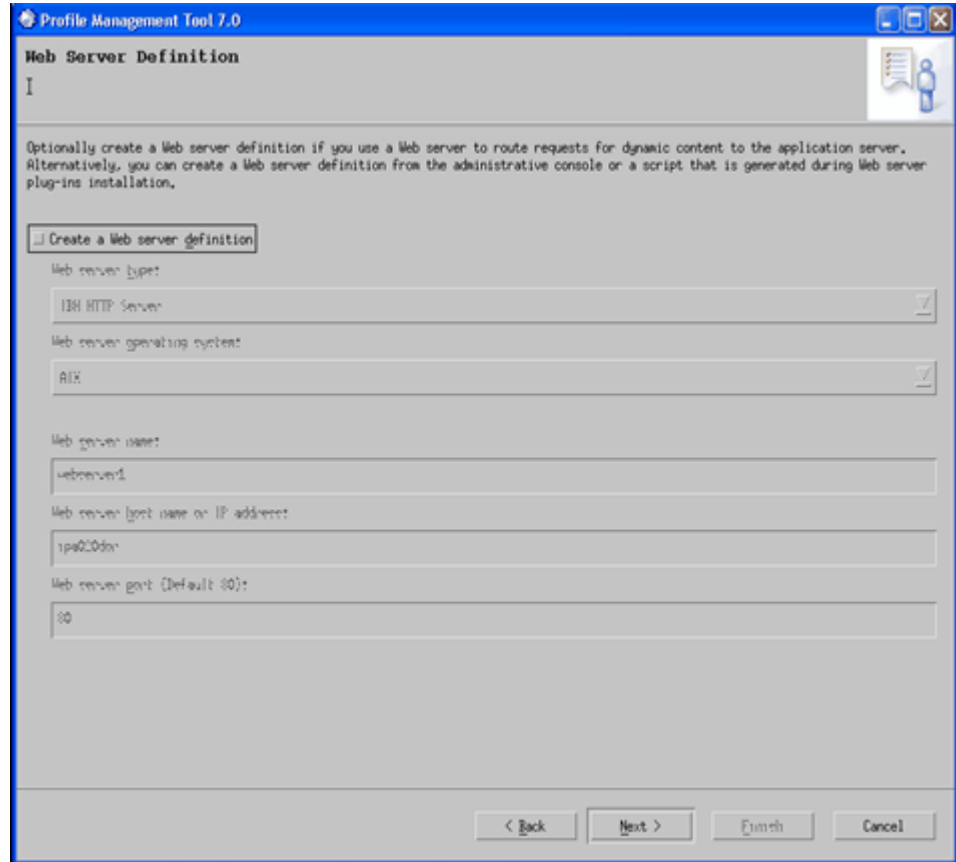

- The Profile Creation Summary screen is displayed. Verify the details displayed in the screen. If any of the information has to be modified, click Back to go to the previous screens and make the required changes. If the information displayed is correct, click Create to continue. This creates an application server profile.

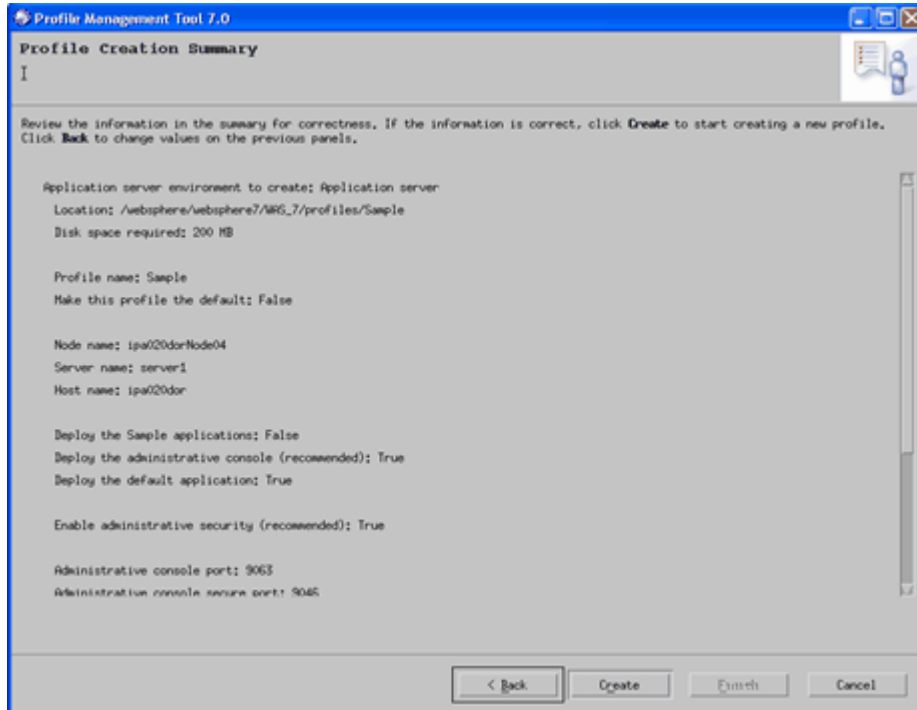

- The Profile Creation Progress window is displayed, which shows the status and progress of the profile creation process.

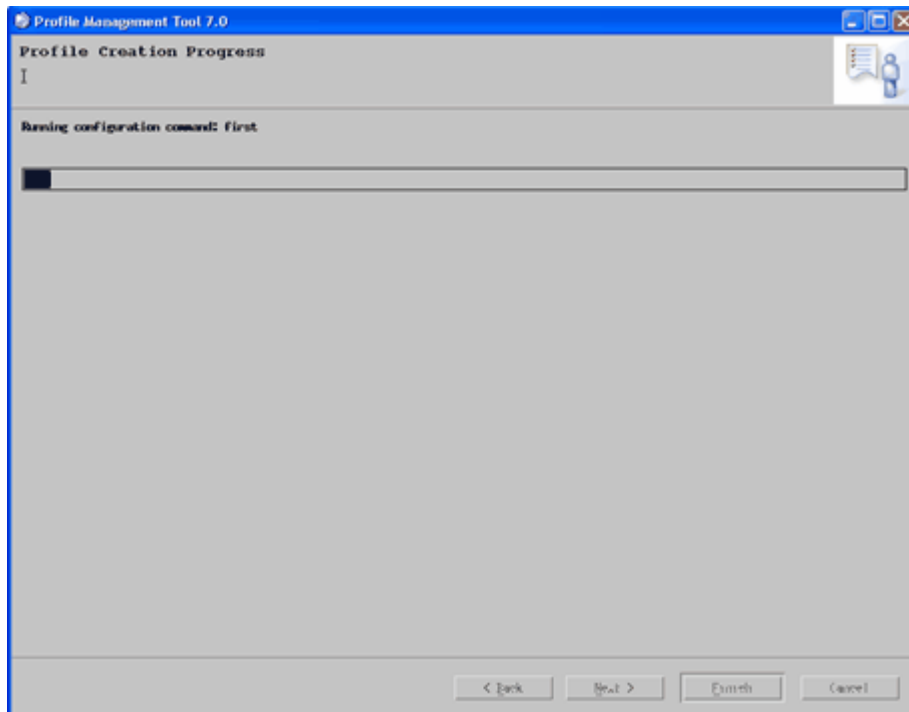

- Once the profile has been created successfully, the Profile Creation Complete window is displayed.

Select the Launch the first steps console check box to run the installation verification test and to start and stop the application server. Click Finish.

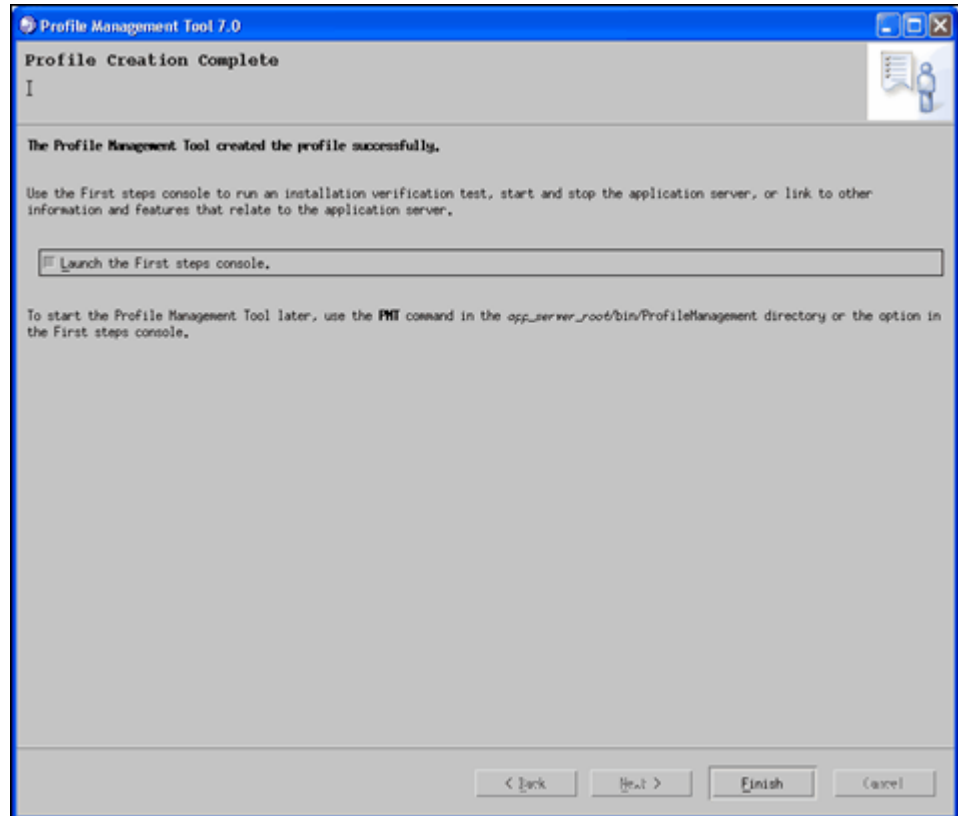

- The WebSphere Application Server – First Steps screen is displayed. Click the Installation verification link to verify that the Profile has been created successfully.



- The First steps output – Installation verification screen is displayed. Verify the details displayed and close the window.

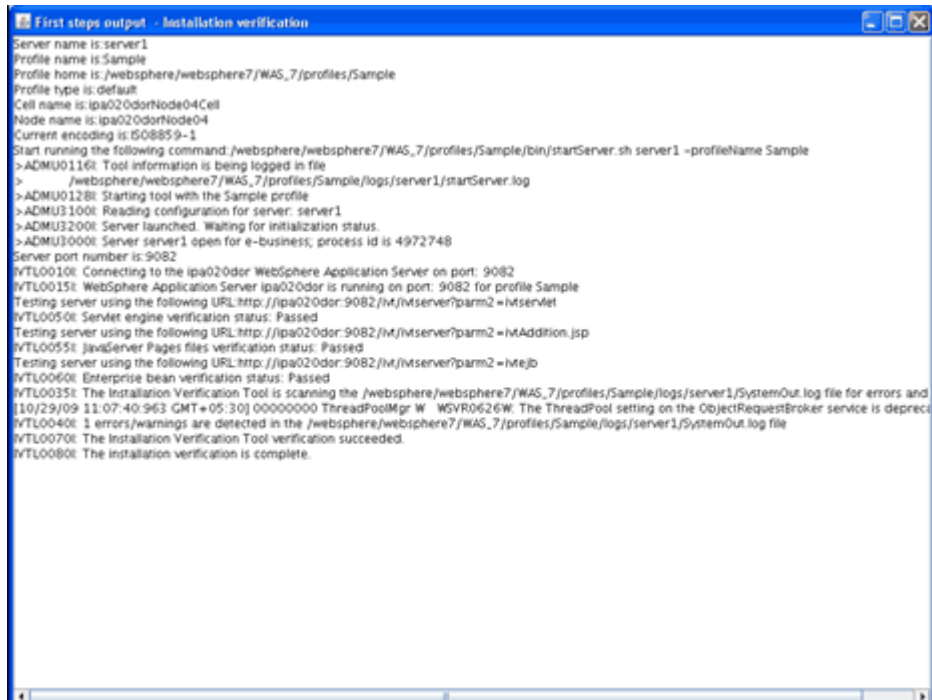

The following steps shows how to manage the installed applications in WebSphere:

Open this URL in the browser window:<http://<ipaddress>:<Administrative Console Port>/ibm/console> [http] .

The Administrative Console Port value can be taken from the serverindex.xml file in <WebSphere Profile Directory>/config/cells/<Node Cell>/nodes/<Node Name> directory.

The Integrated Solutions Console login screen is displayed. Log on with the user id that has admin rights.

Example

<http://10.80.50.53:9003/ibm/console>

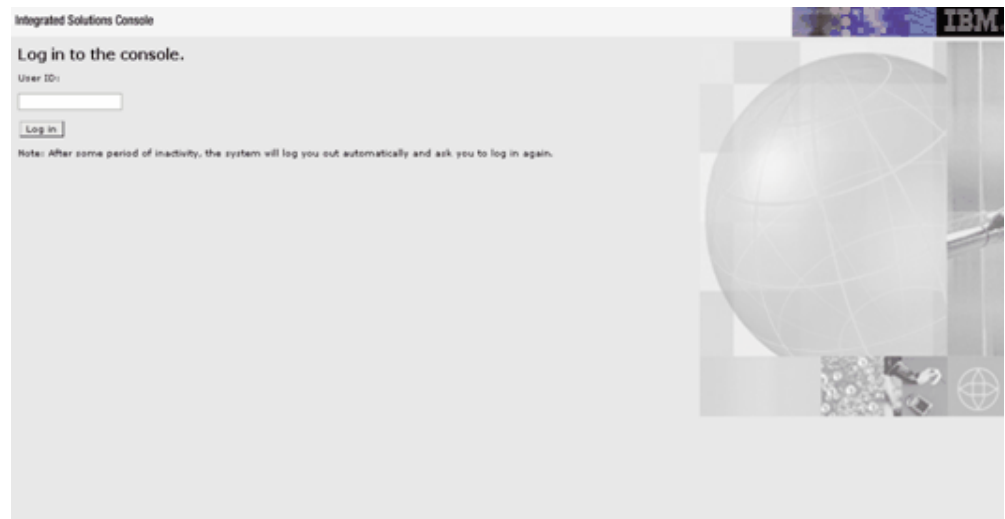

In the left hand menu, expand the Applications > Application Type> WebSphere enterprise Applications. The Enterprise Applications screen is displayed. All the installed applications are displayed in this screen.

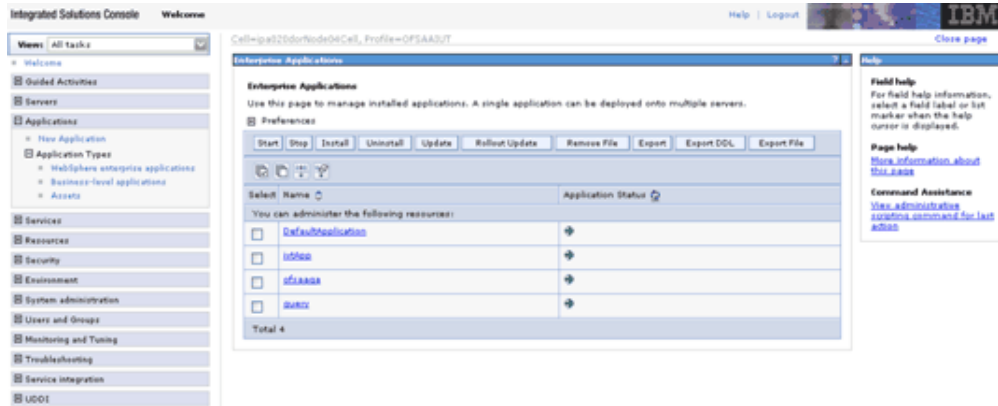

This page helps you in managing the installed applications. You can start or stop the Application Servers from here

Deletion of WebSphere Profiles

The following steps can be done in cases where you need to delete a WebSphere profile:

- Stop the WebSphere profile to be deleted.
- Navigate to the <WebSphere_Installation_Directory>/AppServer/bin/ directory.
- Execute the following commands
- `manageprofiles.sh -delete -profileName <profile_name>`
- Delete the profile folder, for example:
 <WebSphere_Installation_Directory>/AppServer/profiles/profile_name>
- Execute "manageprofiles.sh -validateAndUpdateRegistry".

WebLogic Configuration for Infrastructure Application Deployment

WebLogic Configuration

To enable deployment of multiple Infrastructure applications on a single WebLogic, one must create a stand-alone application server. However, you can use the Domain Creation wizard to create additional stand-alone application servers.

A domain is the set of files that define the runtime environment. At least one domain must exist to run Weblogic Application Server. Steps to create domain in Weblogic is stated below.

Creation of New Domain in WebLogic

Creating New Domain using Configuration Wizard in WebLogic

Navigate to the "<weblogic_Home Directory>/wlserver_10.3/common/bin directory.

1. Execute Config.sh file. The Oracle WebLogic Configuration Wizard is displayed. This wizard will take you through the domain creation process.

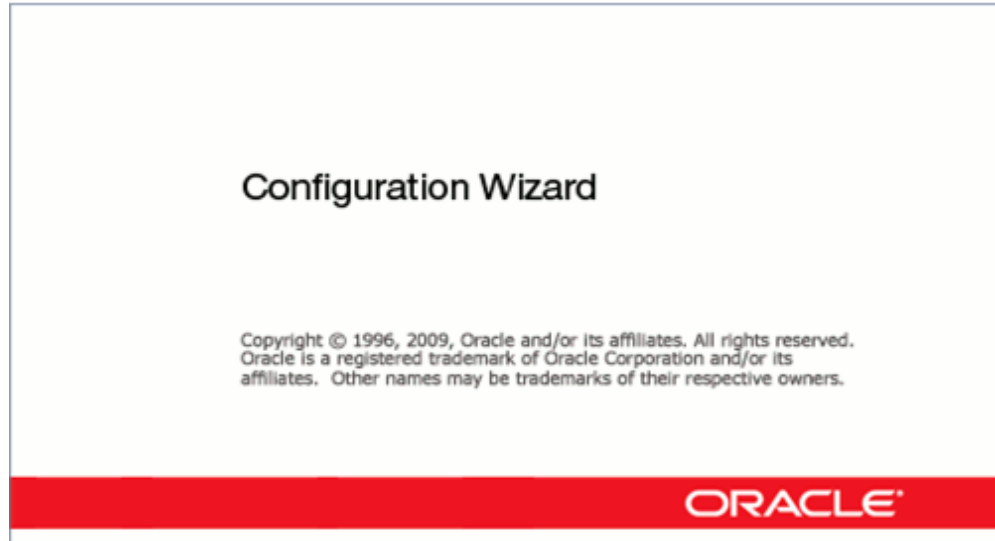

2. In the Welcome screen, to create a Weblogic domain, select the Create a new WebLogic domain option and click Next.

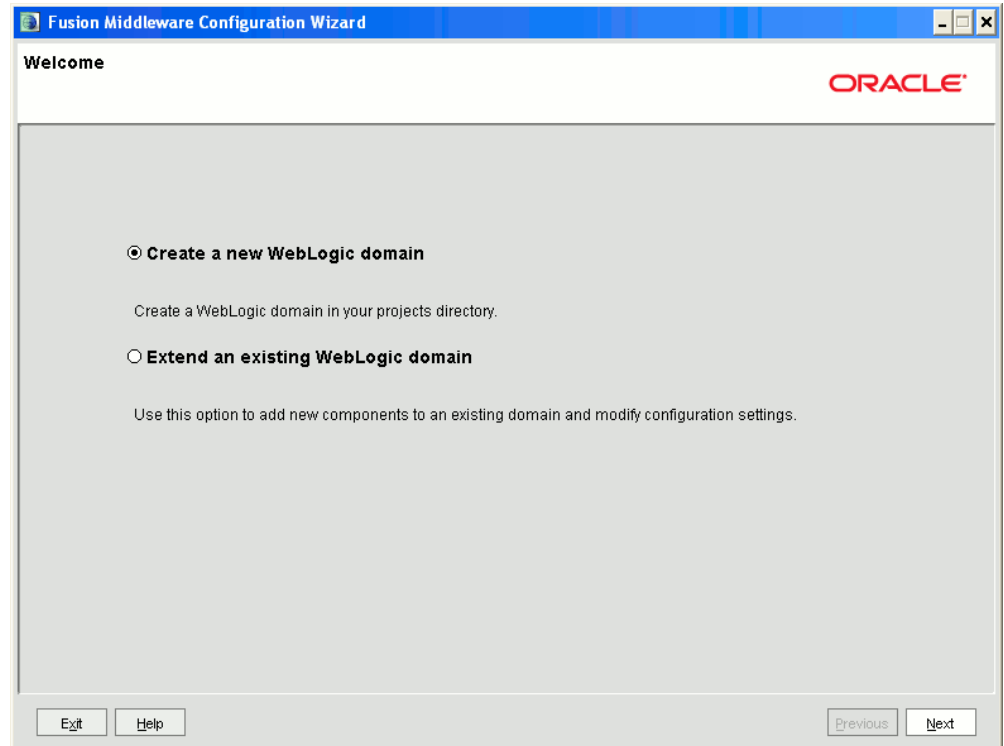

3. The Select Domain Source screen is displayed. Select Generate a domain configured automatically to support the following products option and click Next.

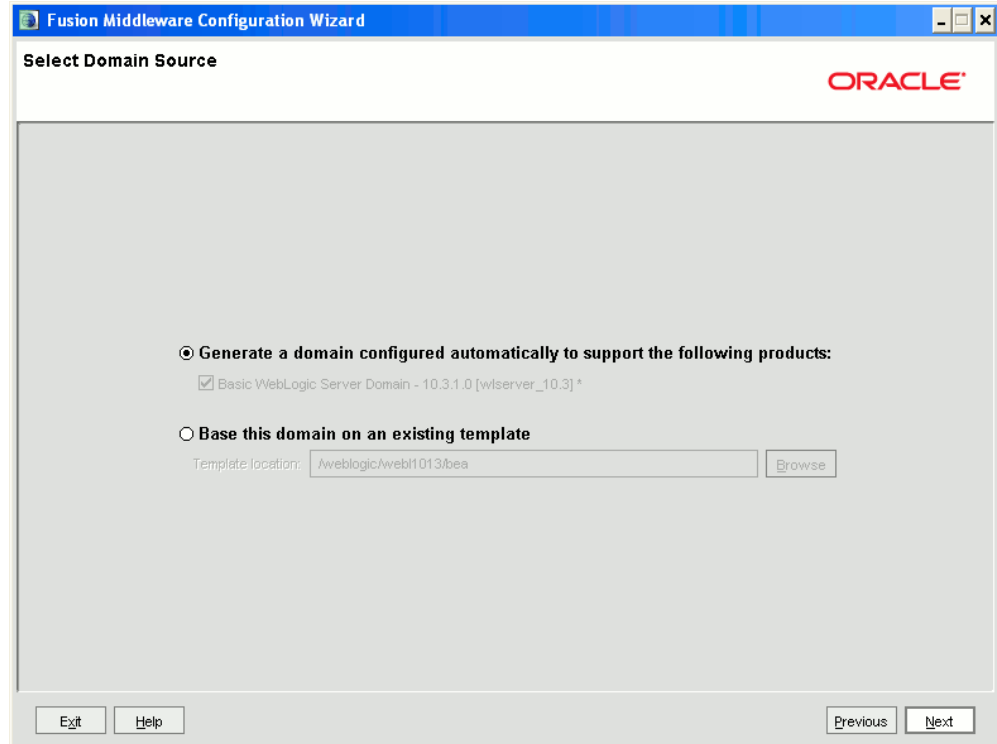

4. Enter the name and location for the domain and click Next. Click Browse to navigate to the WebLogic configuration directory.

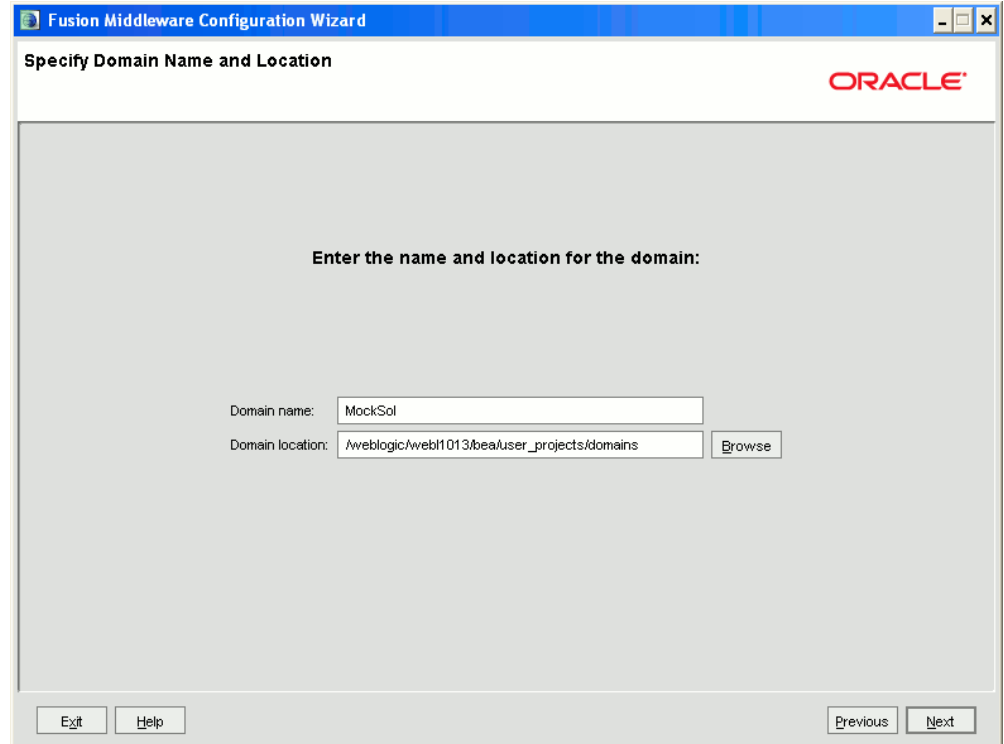

5. The Configure Administrator Username and Password screen is displayed. Enter the username and password to be assigned to the Administrator and click Next. Make sure that the password is of minimum 8 characters.

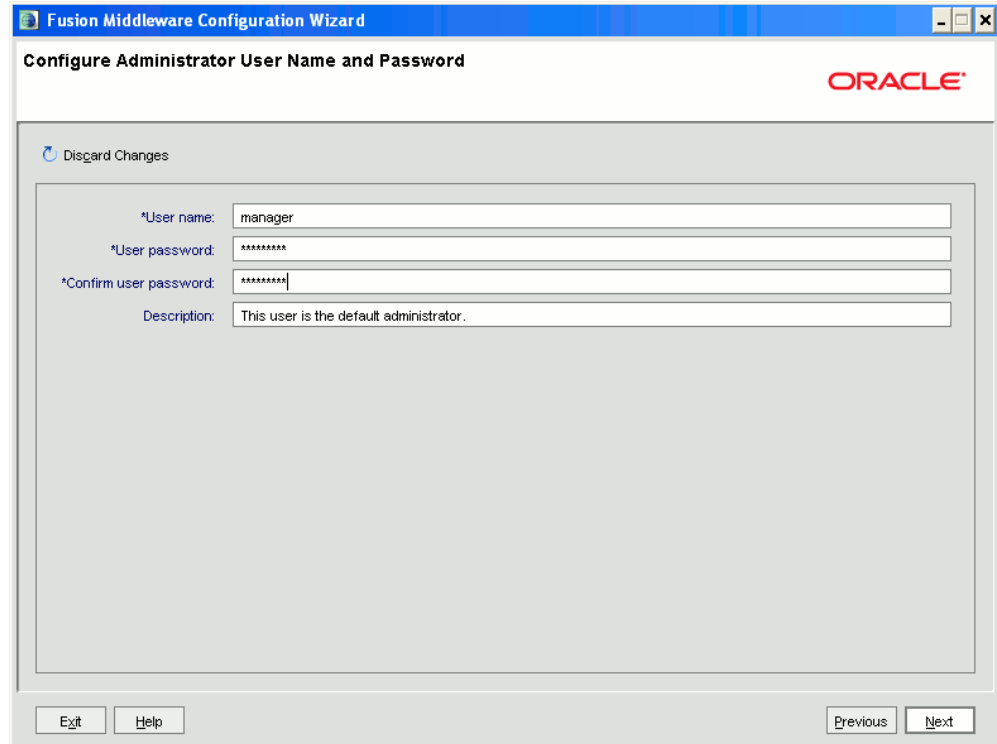

6. The Configure Server Start Mode and JDK screen is displayed. Under WebLogic Domain Startup Mode, select Development Mode. Under JDK Selection, select Other JDK option and Browse the required JDK option. Click Next.

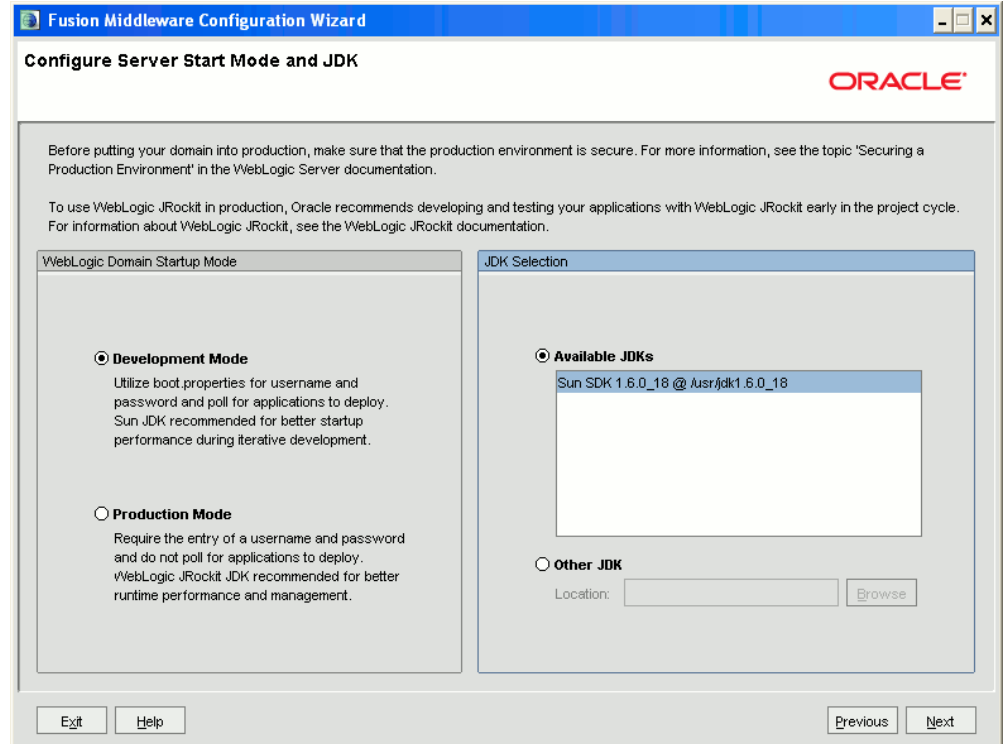

7. The Select Optional Configuration screen is displayed. Select the Administration Server option. The other two options (Manages Servers, Clusters and Machines and RDBMS Security Store) are optional. Click Next to continue.

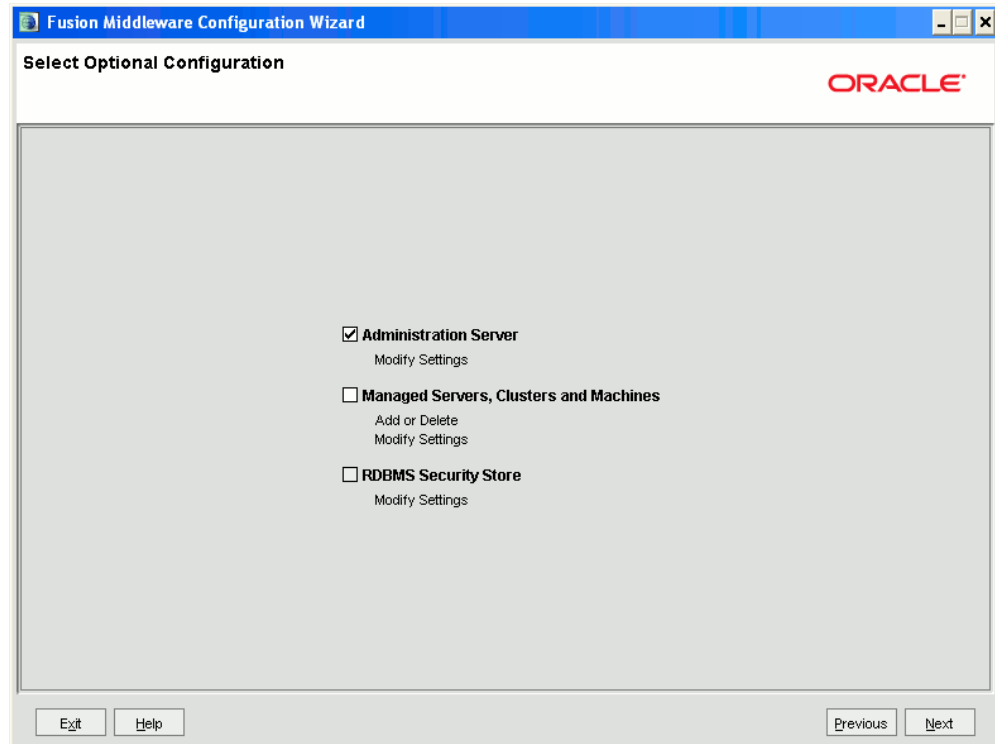

8. The Configure the Administration Server screen is displayed. Each WebLogic Server domain must have an Administration Server. Enter the details of the Administration Server such as the Name, Listen address, and Listen Port in the relevant fields.

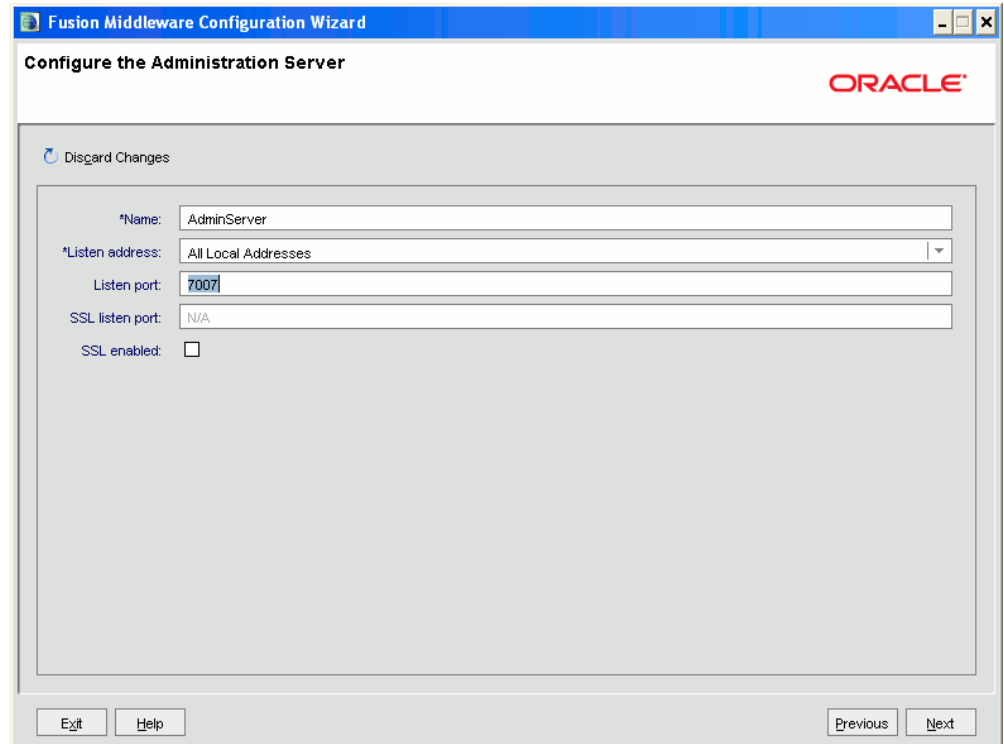

- Make a note of the Listen Port that would be keyed in here. Example: 7005. This port must be given in the servlet port field during Infrastructure installation.
9. The Review WebLogic Domain screen is displayed. Verify the contents of your domain in this screen and click Create to continue. This creates a domain server thereby enabling deployment of multiple Infrastructure applications on a single WebLogic.

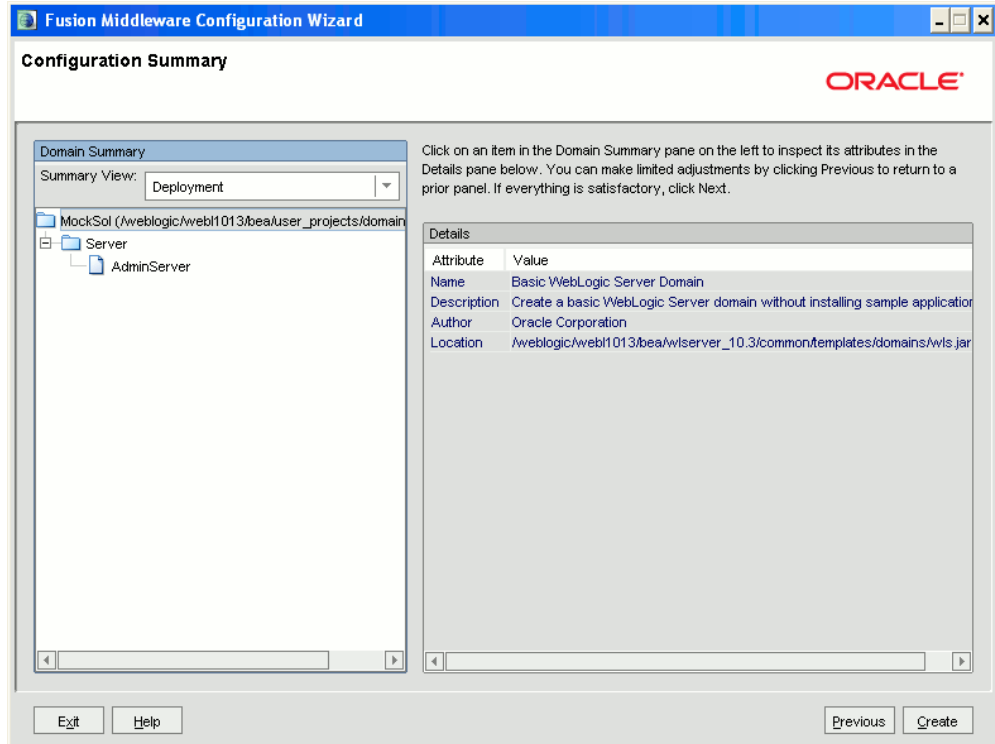

10. The Creating Domain screen displays the progress of the domain creation process. Once the domain is created successfully, click Done.

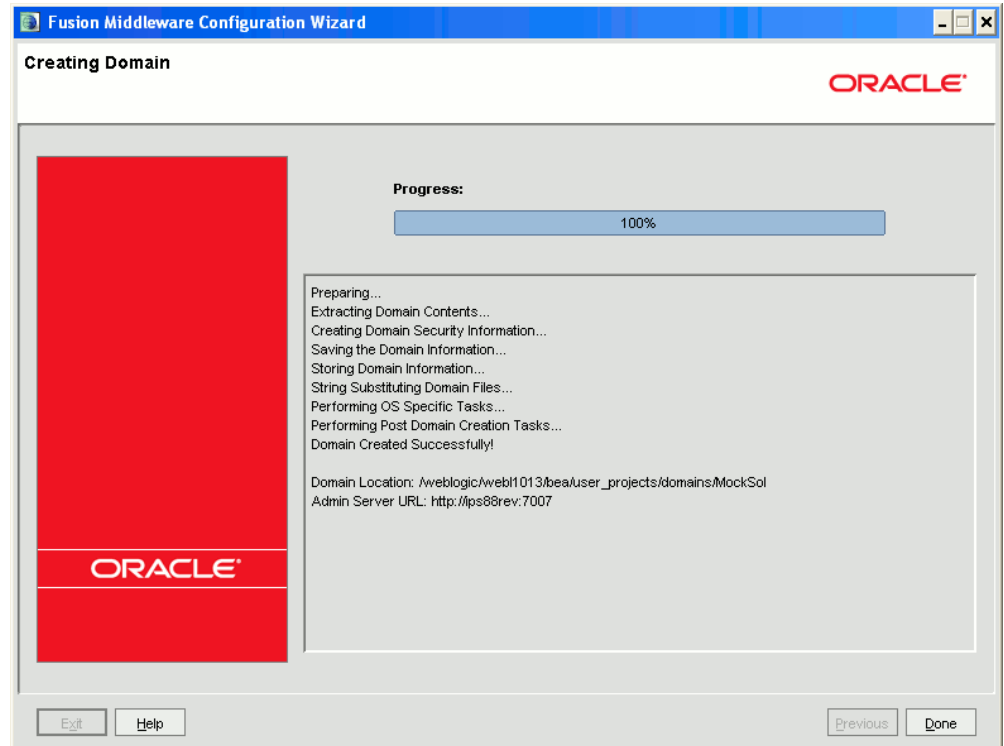

Deletion of a Domain in WebLogic

- Navigate to <WebLogic Installation directory>/user_projects/domains/<domain name to be deleted>/bin Directory.
- Execute stopWebLogic.sh to stop the Weblogic domain.
- Delete the directory<WebLogic Installation directory>/user_projects/domains/<domain name to be deleted>.

Installing Infrastructure

Installation Process

Step by step instructions for installing Infrastructure on a single tier mode is as follows:

Login with the user account that has admin rights on the machine and copy the files Setup.sh, OFSAAInfrastructure.bin, libcpptriplesdes.so and CustReg.DAT from the source (that is: CD / E-delivery) into a particular directory.

Grant execute permission for Setup.sh, OFSAAInfrastructure.bin, libcpptriplesdes.so and CustReg.DAT.

Execute the **.profile**.

On the machine, navigate to the directory where Setup.sh has been copied. To begin the Infrastructure installation, type ./Setup.sh at the command prompt.

Click the Help button in the Infrastructure Installation screens to view the instructions specific to the screens.

- Installation should be done using Hummingbird Exceed 7.0
- The Infrastructure Setup screen is displayed. Click Next to continue.
- At any point during the installation process, if you click on Cancel, an alert window is displayed. Click Quit on the alert window to abort the installation process and exit the setup. Click Resume to continue.
- At any point during the installation process, if you click Previous, you will return to the previous screen.

You have two options for installing Infrastructure. The options are:

1. GUI Installation - If the GUI is selected then you will be requested to key in all the Installation parameters through the wizard.
2. Pre-configured Installation - If the Pre Configured option is selected then you will be able install Infrastructure with the configured OFSAAI_InstallConfig.xml file.

GUI Installation

The Installation process screen appears as shown in the figure



The License Agreement screen displays the License Agreement. Accept the License Agreement and click Next to continue

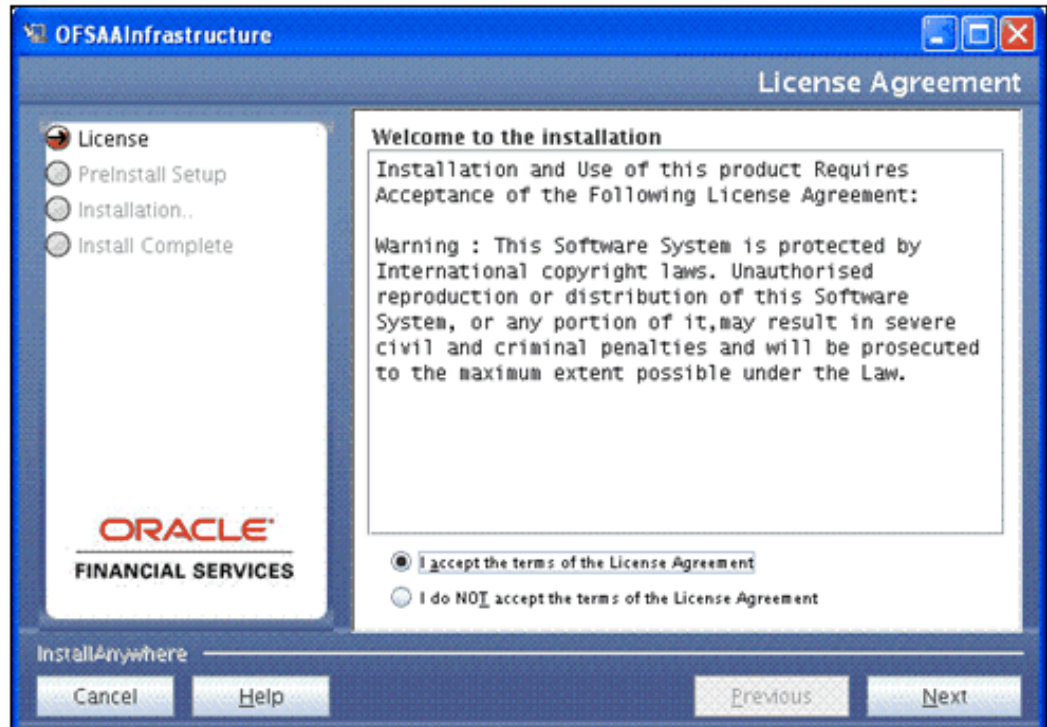

License Key and Customer Code:

Enter the license key in the License key field and 'EDELIVERY' in all caps in the Customer Code text field.

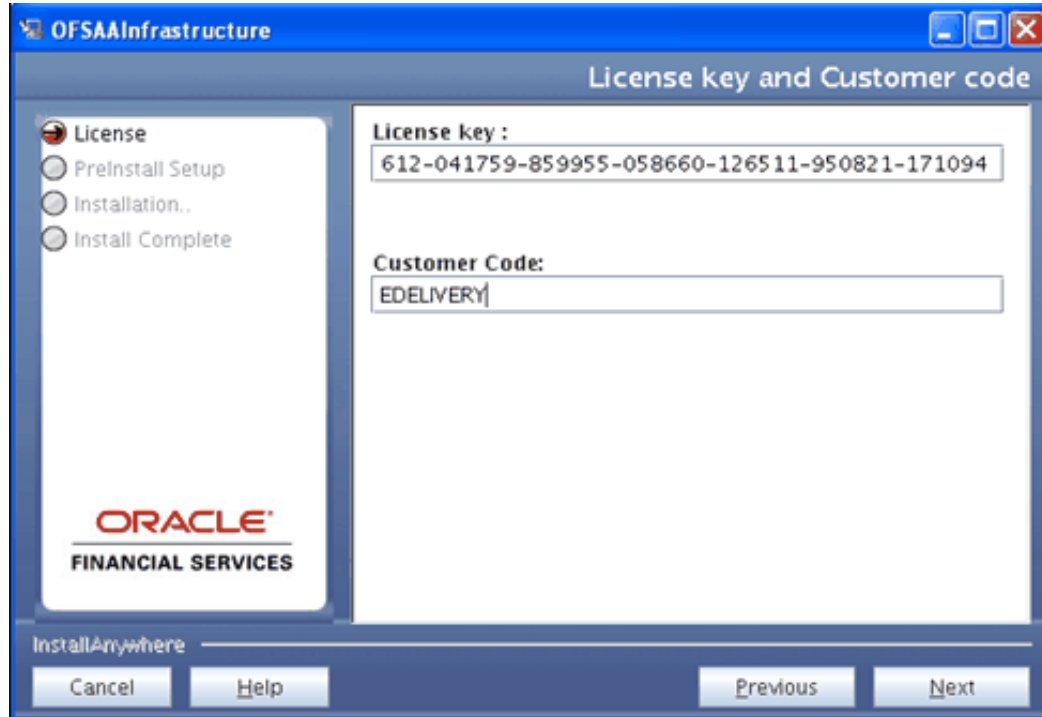

- The License key is dependent upon the Applications to be installed. A different key is required if installing Oracle Funds Transfer Pricing, Oracle Profitability Management and/or Oracle Asset Liability Management. For further information on obtaining the correct key, please contact Oracle Financial Services Support.
- If an invalid license key is entered, an error message appears. Click OK to clear the error message and return to the License key screen to enter the correct license key.

License and Customer Details:

After the successful validation of the OFSAAI license and Customer Code, the License and Customer Details screen appears.

Details regarding the Operating System, Relational database, Number of licensed users, OFSAAI components license for installation, and local language support are displayed along with the customer who has acquired the OFSAAI License.

If the displayed information is different from the purchase order you have placed, exit from the installation and bring the discrepancy to the notice of Oracle Financial Service Support.

Click Next to continue.

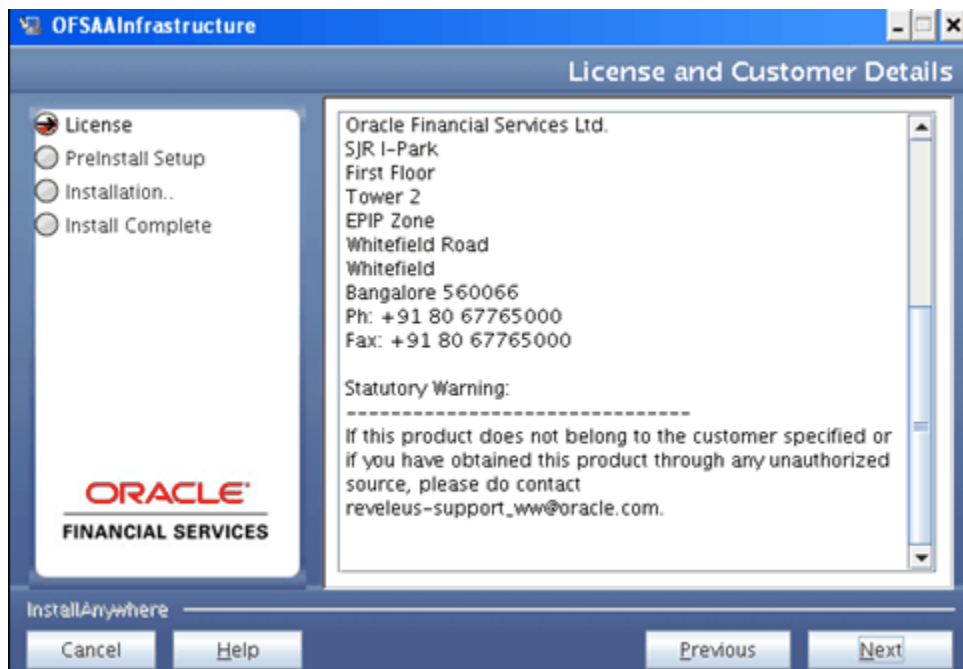

OFSSAI Installation:

The OFSSAI Installation screen provides an option to proceed with the installation.

The Options are:

- GUI

- Pre Configured

If GUI is selected, all the Installation Parameters need to be keyed in through the Installation Wizard. Select Pre Configured if all the Installation Parameters are saved in the OFSSAI_InstallConfig.xml file before proceeding. Refer to the Installation manual for details of Populating OFSSAI_InstallConfig.xml. If Pre Configured is selected, choose the Directory where configured OFSSAI_InstallConfig.xml is located. Click Next to continue.

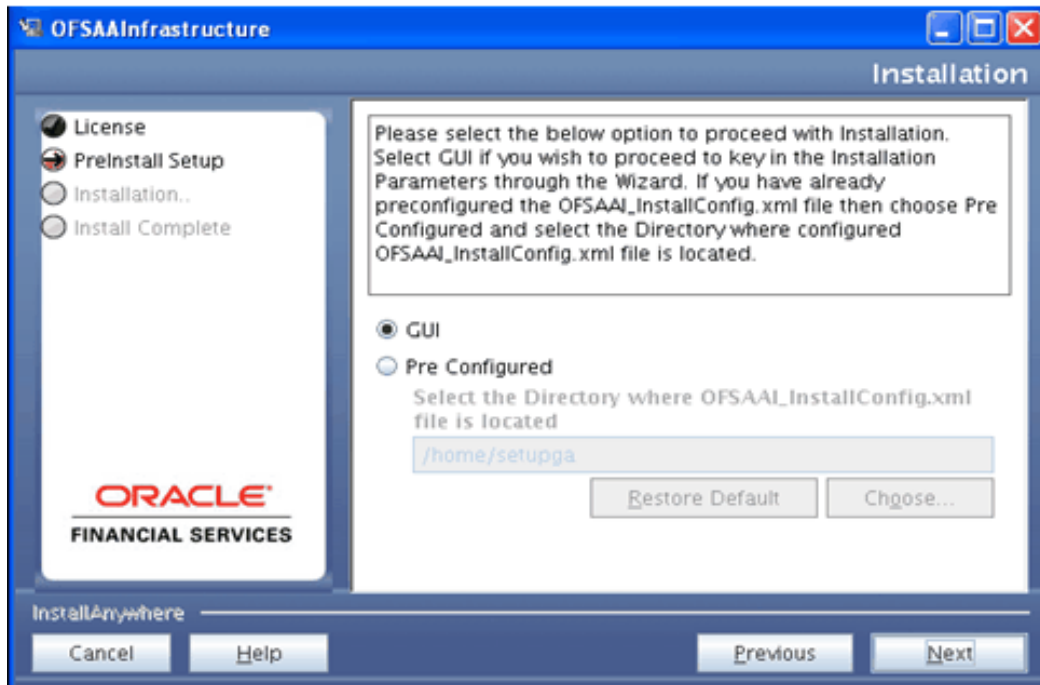

- **OFSSAI Installation Mode:**

The Installation Mode screen requests the mode of installation. Select either Single Tier or Multi Tier depending on the OFSSAI architecture you have decided.

If Single Tier is selected, all the components (OFSSAI Web Components, Application Components, and Database Components) are installed on one server machine.

If Multi Tier is selected, each/all of the OFSSAI components can be installed on different machines and you can choose the component you wish to install in a particular machine.

Click Next to continue.

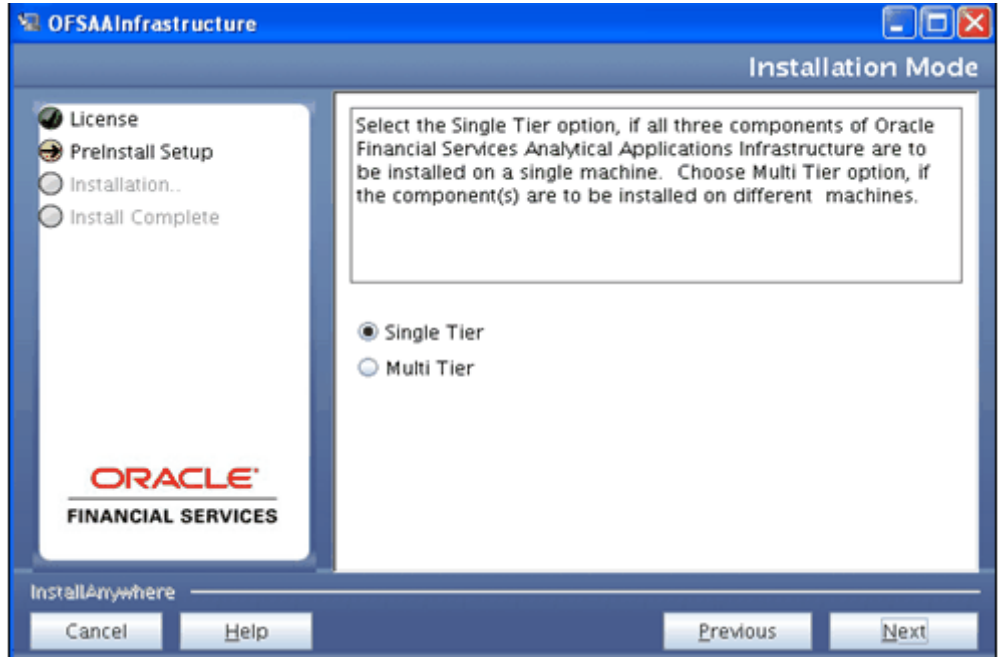

Specify Installation Directory:

The Specify Installation Directory screen asks for the installation directory.

Enter a valid path where OFSAAI components (Web, Application, and Database components) are required to be installed.

Alternatively, click Choose... to browse through the directory structure on the machine to select the path. Click Next to continue.

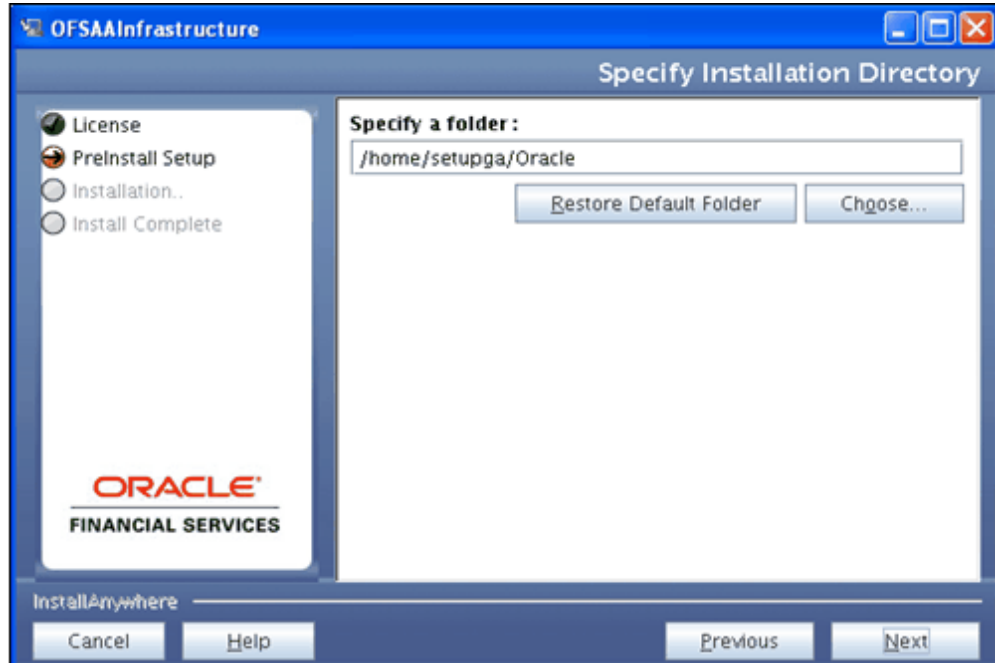

Webserver:

The Webserver screen requests for the type of Servlet engine being configured for the OFSAAI installation. Select a webserver and click Next to continue.

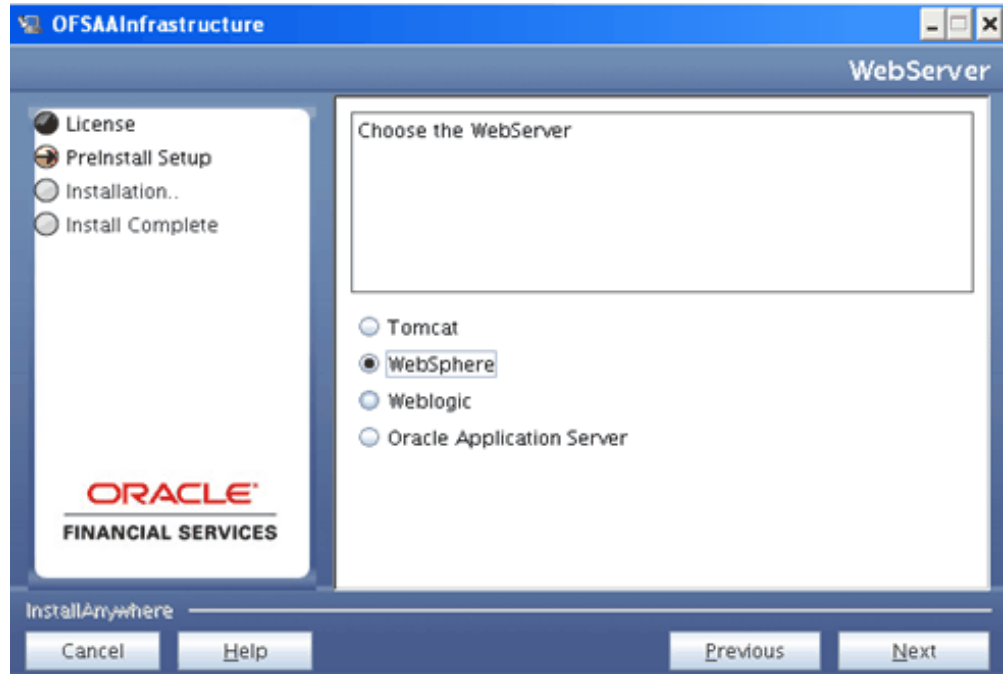

OFSAAI Web Services:

Select YES, if you wish to configure OFSAAI Web Services during OFSAAI Installation. If not, Click No. Click Next to continue

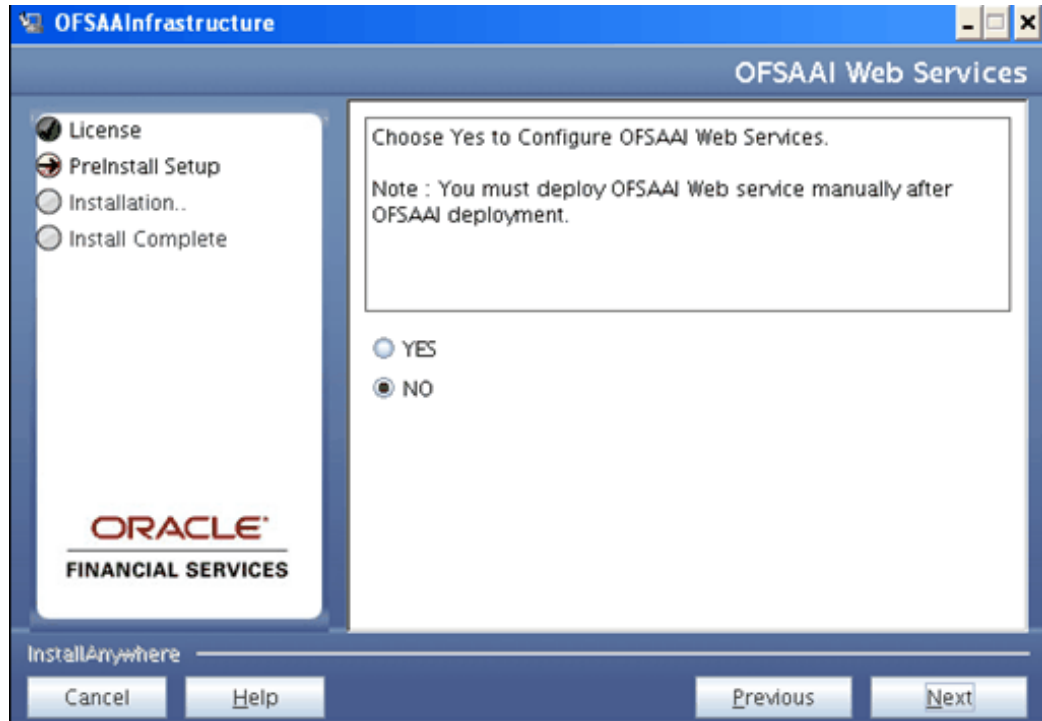

- If you have chosen No, and wish to configure OFSAAI Web Services as a Post Installation Activity, refer to Configuring Web Services and Deploying OFSAAI Web Services sections in the OFSAAI Installation Manual for instructions.
- If you have chosen Yes, only the configuration will be done. The deployment activities have to be carried out manually after the OFSAAI application deployment. Refer to Deploying OFSAAI Web Services section in the OFSAAI Installation Manual for instructions.

Absolute Java Path

Click Choose... to browse through the directory structure on the machines and select the absolute path where the Java executables resides. Enter the valid path in the space provided.

Click Next to continue.

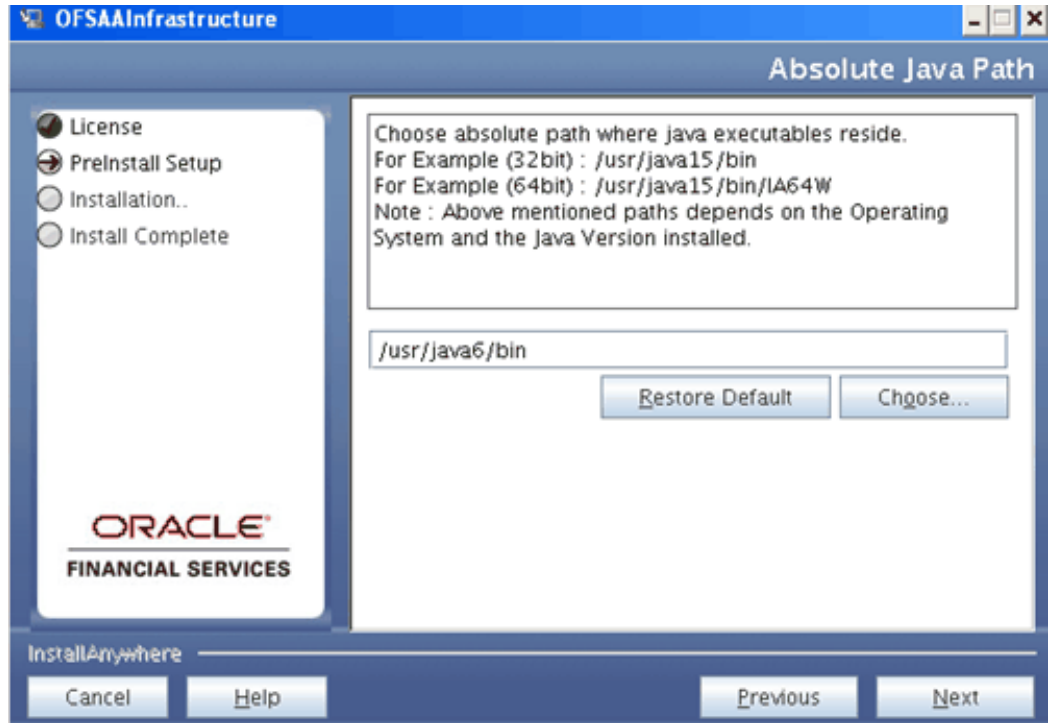

Server Details:

This screen requests for system details.

The IP address of the current machine will be displayed in the space provided under IP address/hostname of server.

Edit the Database Engine IP address that is displayed in the IP address/hostname of Database Engine field, if Database Engine is not in the local machine and is in a remote system.

Enter the IP address of the machine which SMTP service is running in the space provided under 'SMTP Server IP/hostname'. This is optional and is required only for the mail configuration in the Data Entry Forms and Queries module of OFSAAI.

Click Next to continue.

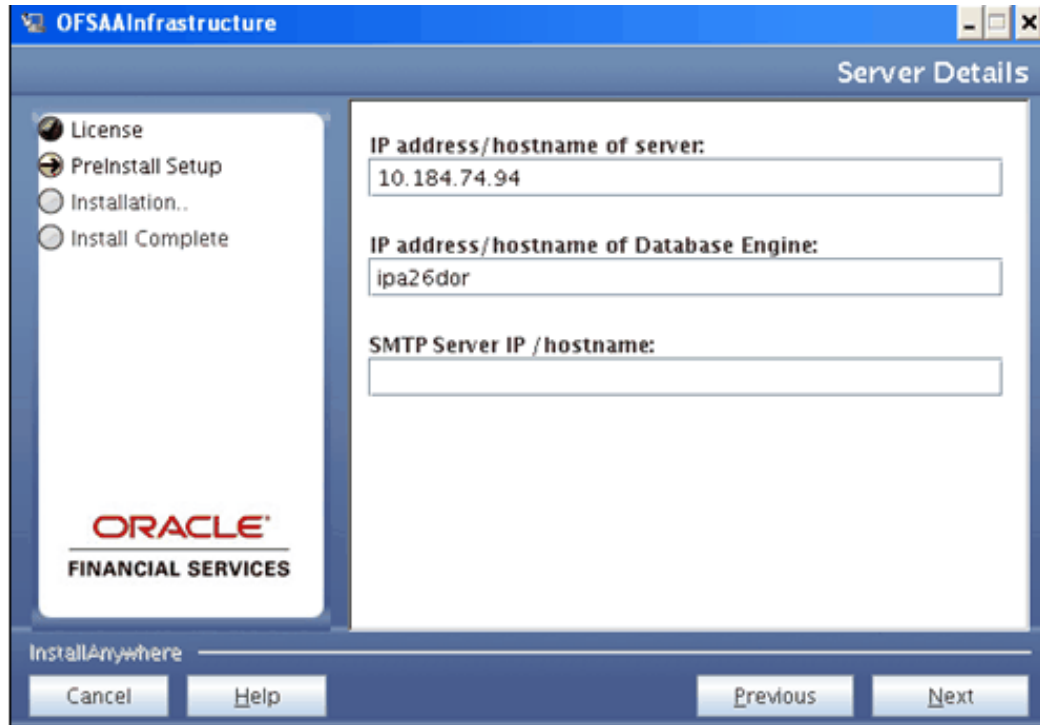

Note: • The Server Details screen will be displayed only if you have selected Single Tier OFSAAI Installation architecture. In case of Multi Tier architecture, the screen displayed would be Application Server Details, Web Server Details or Database Server Details depending on the layer that is being installed in the machine.

Websphere Setup Details:

This screen requests for the Websphere installation directly. Click Choose...to browse through the directory structure on the machine and select the path up to the hostname.

Alternatively, enter the valid path in the space provided . Click Next to continue.

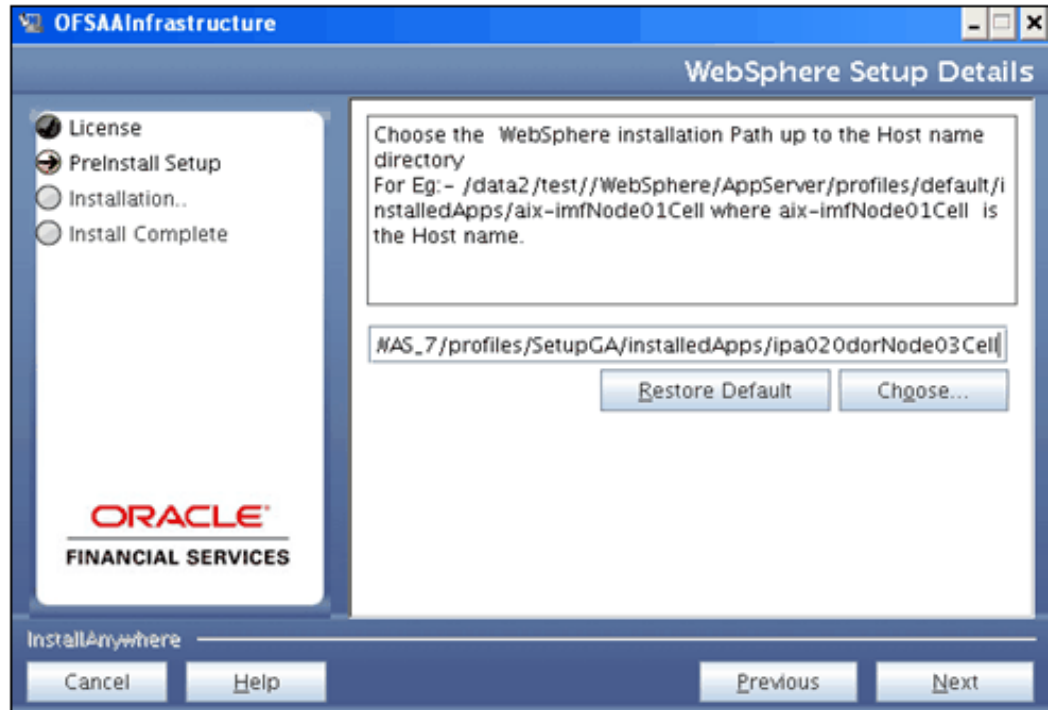

- You must select the path up to <WebSphere Installation directory>/installedApps/<NodeName>.
- Make sure that you have completed the configuration mentioned in the OFSAAI configuration for FUSION section in the OFSAAI manual before proceeding to Creating and Deploying the war files in Tomcat sections.
- If you are entering the Websphere Installation path in the field, make sure that it is verified and correct.

Web Server – Context Root:

This screen requests for the type of Server protocol. Enter a Context name for the deployment in the corresponding field.

Select Enable HTTPS check box to enable https. Leave the box unchecked for default HTTP protocol. Click Next to continue.

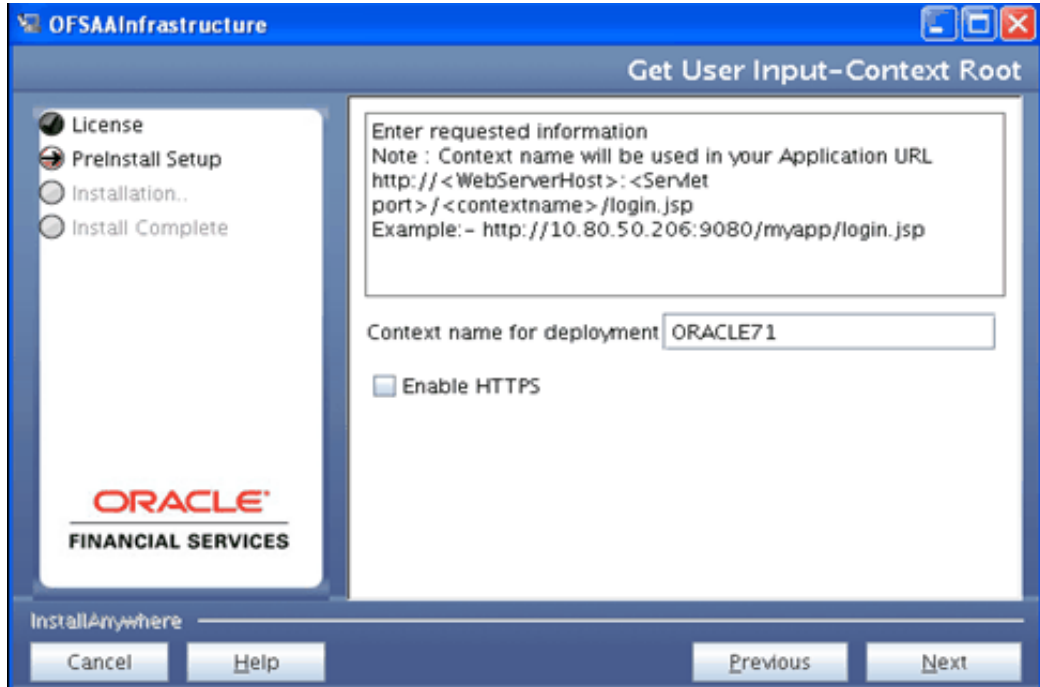

Oracle - Database Details:

Enter the Oracle Config Schema Username, Oracle password, Connect String (SID), Port, and Oracle Driver path.

Click Next to continue.

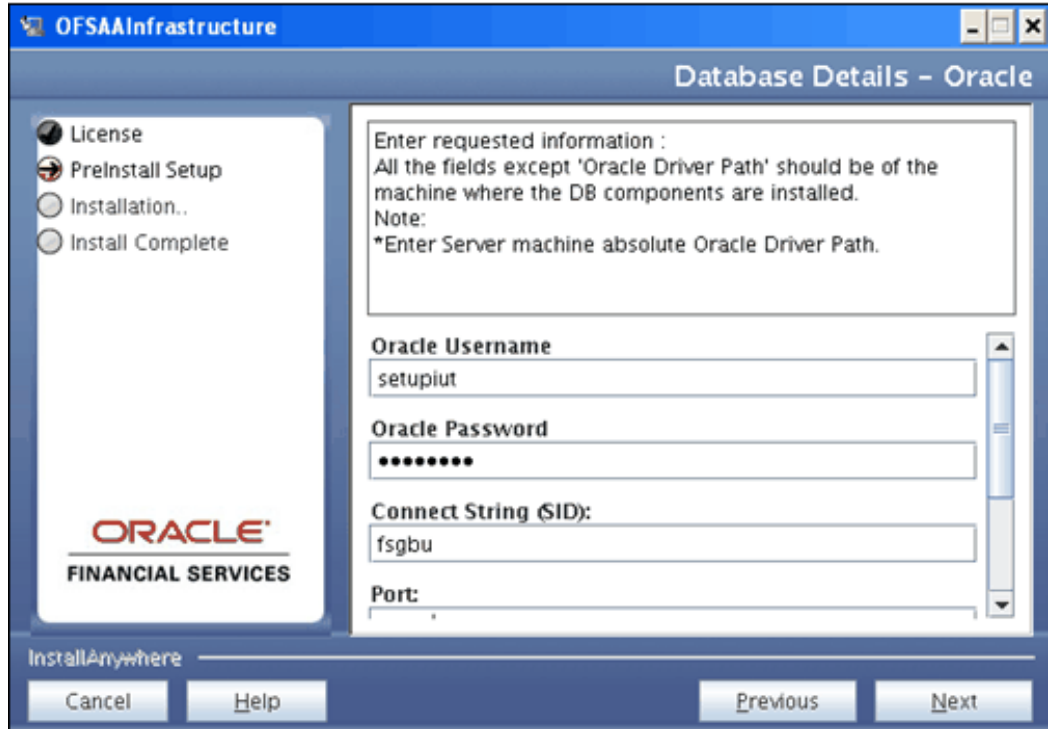

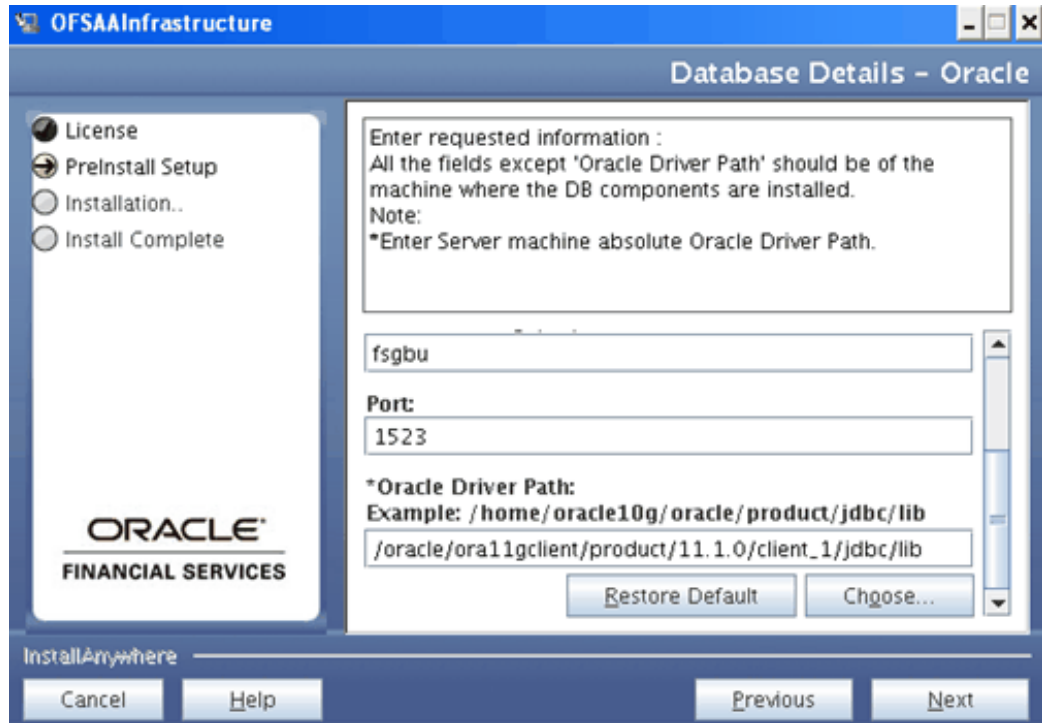

- The Oracle Config schema user must have all the mentioned privileges in the pre-installation section of the installation manual.
- The Oracle driver path refers to the path where Oracle 11g has been installed on the machine. The absolute driver path should be provided here. If Oracle 11g installation path is not shown, you will need to cancel the installer and set the ORACLE_HOME to the Oracle 11g in the .profile file of the user installing the application. Please refer to the Oracle Database Configuration section in the Pre-Installation Activities Checklist chapter.

Note for Linux platform installation:

ORACLE_HOME should be set to 32-bit Oracle 11g Client installation path. It is required to use the 32-bit Oracle Client libraries even for a 64-bit Linux server.

Communicating Ports:

This screen allows you to change the default port numbers to the desired port numbers for various services.

Enter the desired port numbers against the services for which you wish to change the port numbers in the space provided. If port changes are not required for certain services, the corresponding fields can be left blank.

The database details are automatically selected based on user input, earlier during the installation process.

Click Next to continue.

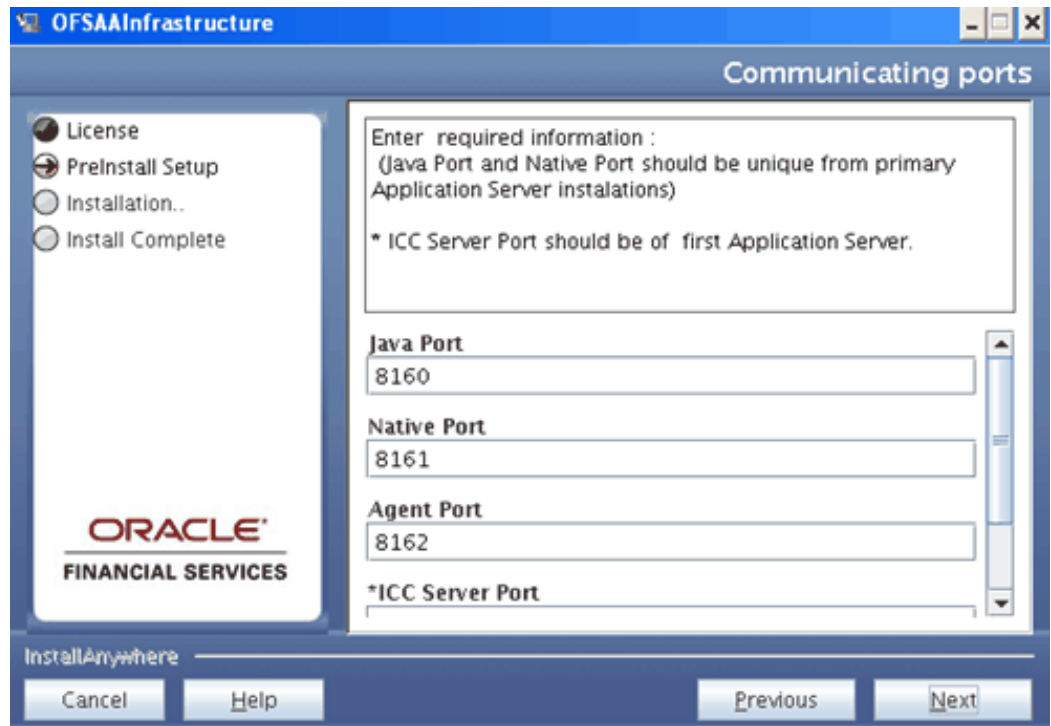

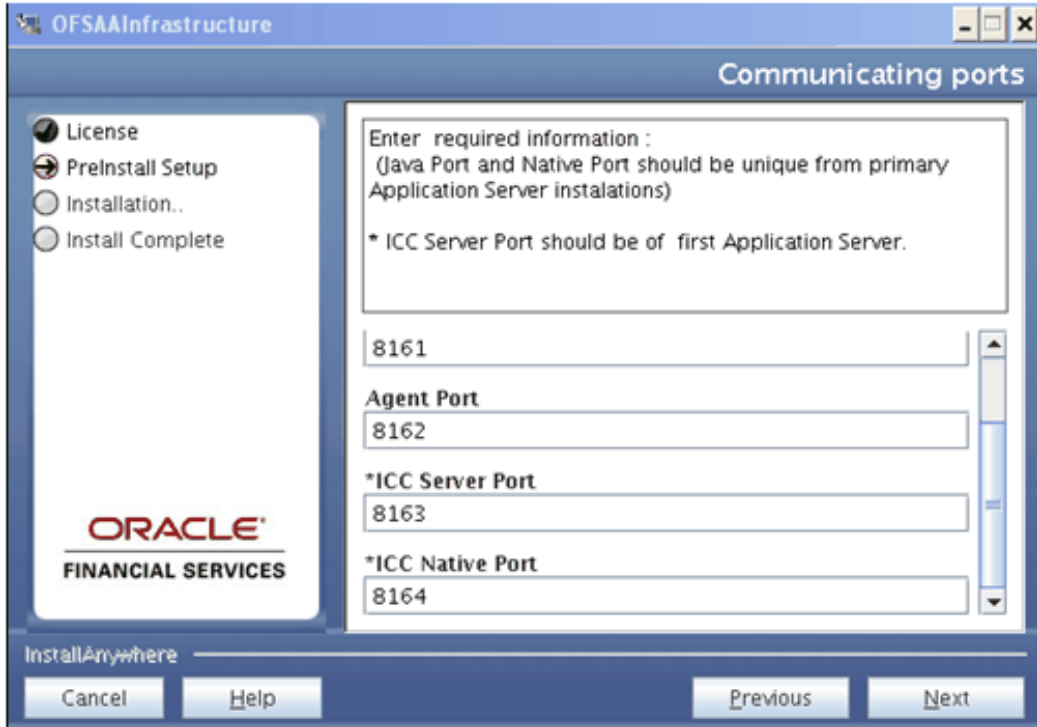

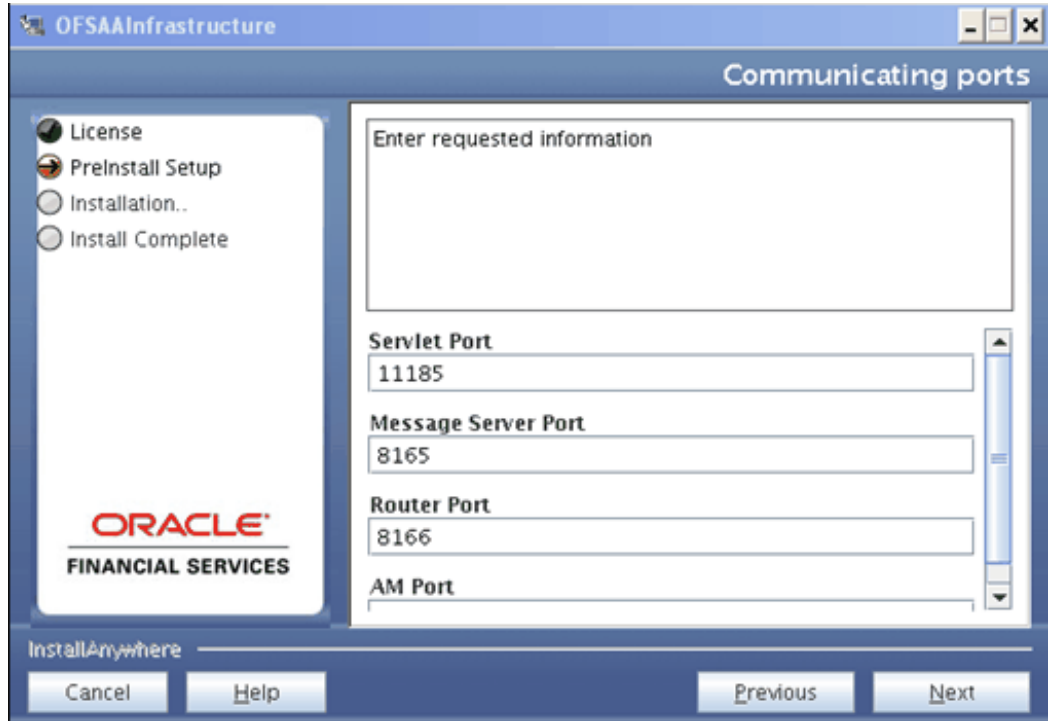

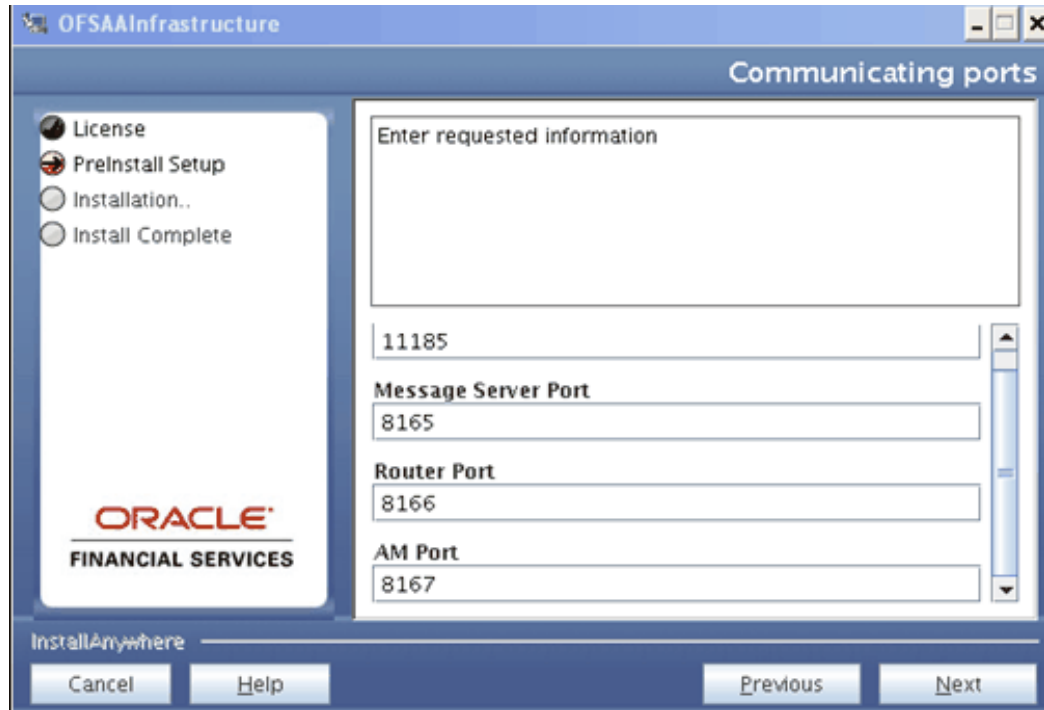

- The port numbers should range from 1025 to 65535.
- This screen will be displayed only on successful validation of your database details provided in the earlier screen. In case the database details are not validated, appropriate error messages or information will be displayed.
- You can choose to perform port changes at a post installation activity. Refer the Post- Installation Steps section in the OFSAAI Installation Manual for more details.
- In a Multi-tier setup, the port details have to be entered only for the installation of the first component/components. For the subsequent installations of the OFSAAI components, the ports information will be automatically populated.

Locale Configuration:

Select the locale installed on the OFSAAI database Server from the drop-down list and click Next.

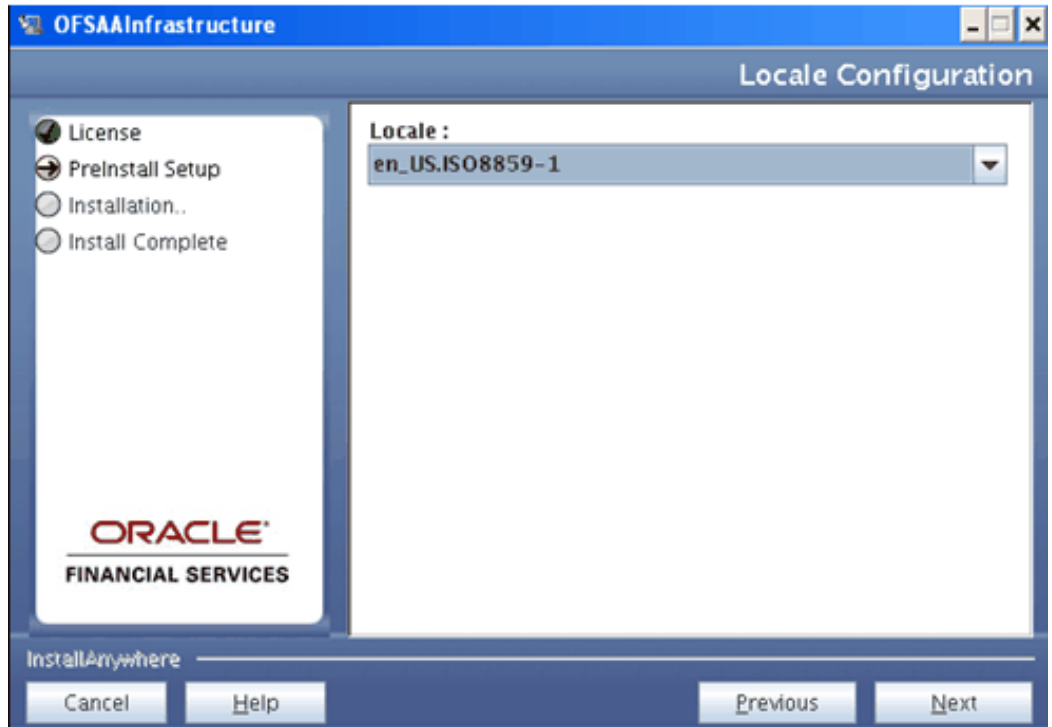

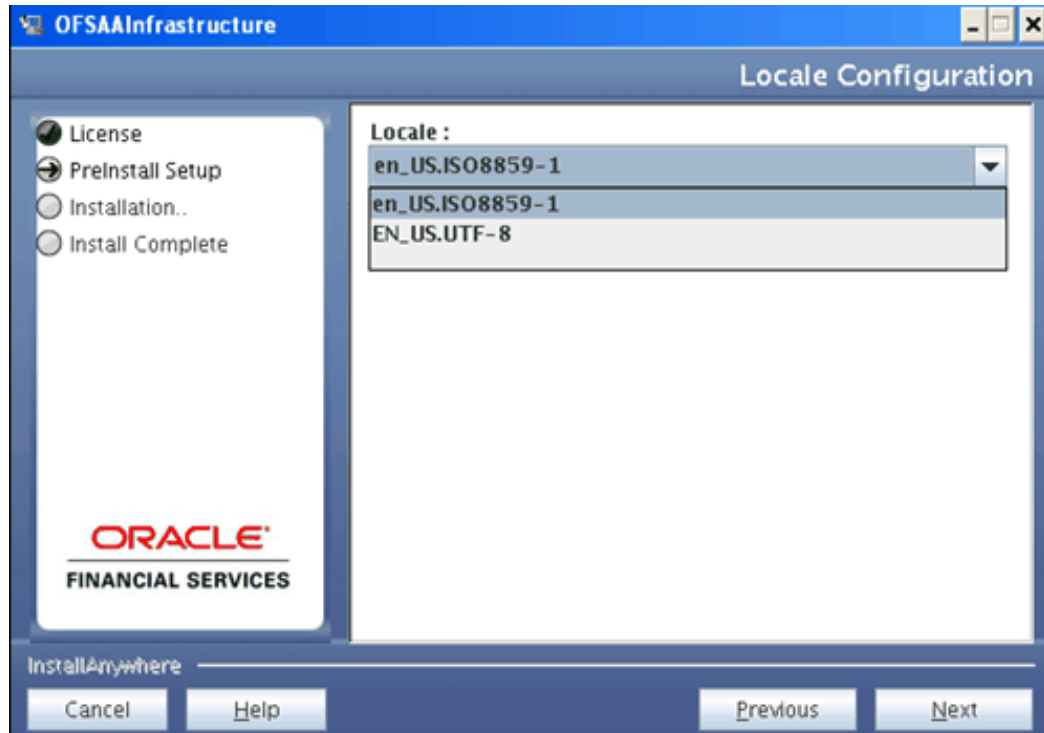

User Configuration:

OFSAAI provides you with the option of using LDAP (Lightweight Directory Access Protocol) authentication or OFSAAI authentication for logging on to OFSAAI. If you wish to use LDAP, make sure that the LDAP server is installed and configured. For more information refer to Installation Manual.

Choose the type of OFSAAI you wish to configure. Select the LDAP Users option if you wish to use the LDAP authentication for logging on.

If you wish to use the OFSAAI authentication provided by the SMS module of OFSAAI, select the SMS Users option.

Click Next to continue.

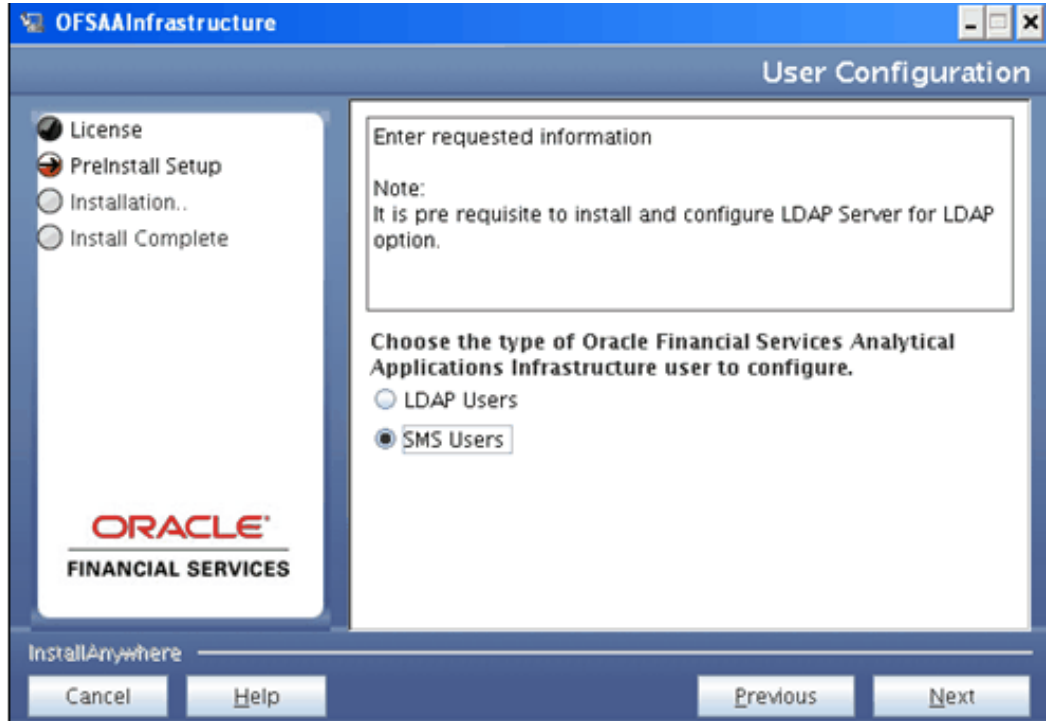

Pre Installation Summary

Review the Product Name, Version, Installation Folder, Required Space, Available Space, Selected Locale, and Warnings before continuing.



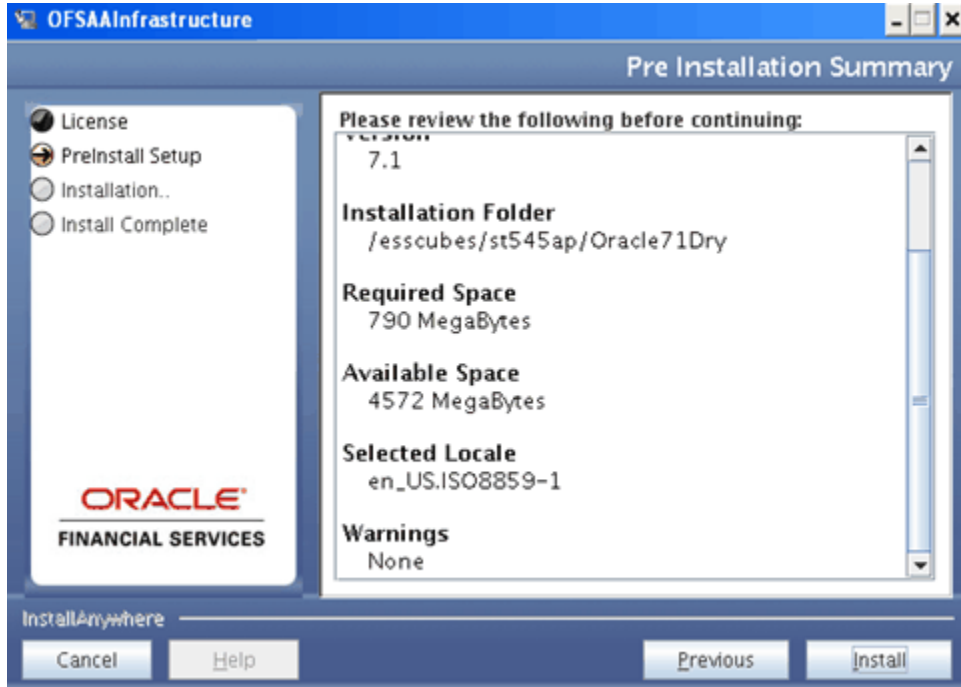

Installing OFSAAI

The installation process begins. This may take several minutes.

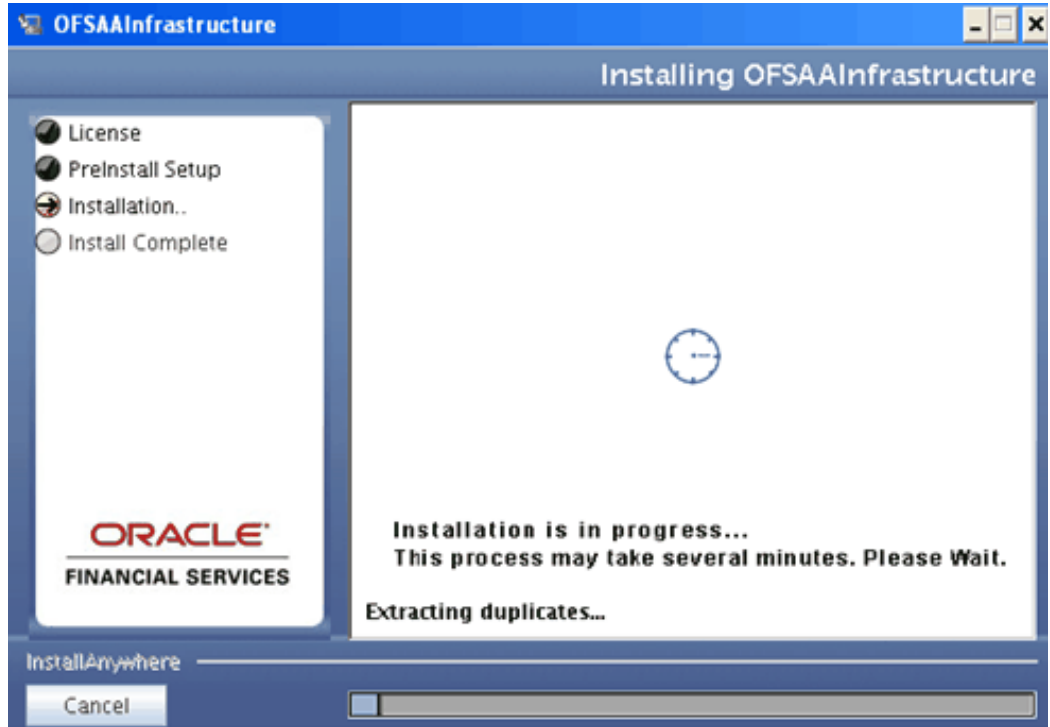

Installation Complete:

After OFSAAI has been installed, click 'Done' to exit the installer.

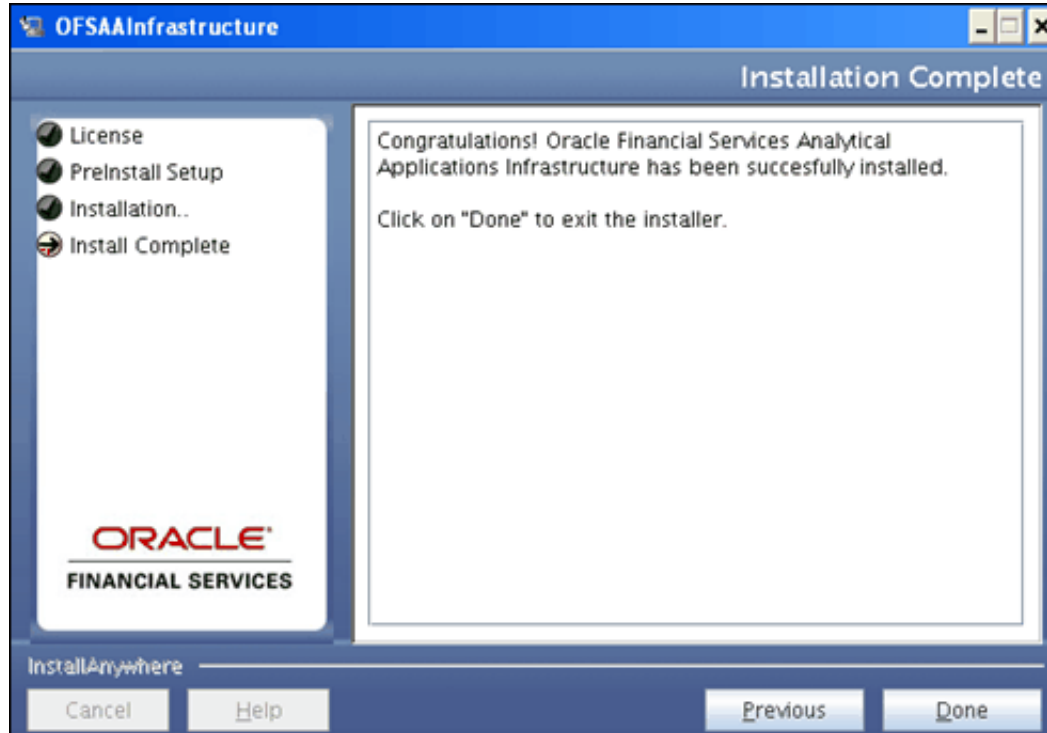

Pre Configured Installation

The OFSAAI_InstallConfig.xml must be populated for pre-configuring the Infrastructure installation. This file contains the following four layers.

- ALL
- APPLICATION
- DATABASE
- WEB

Layers are divided into different Interaction Groups. The Interaction Group defines the type of Interaction Variables. Interaction Variables contains the Interaction Parameters required for the installation of Infrastructure.

Layer - ALL

The Layer, ALL (<Layer name = "ALL">) contains the following nodes which enable to define the parameters for the following Interaction groups.

- Infrastructure Installation Mode – Specifying the Installation Mode as Single Tier or Multi Tier

- Choose Component(s) – Choosing the Infrastructure components to be installed.
- Specify Installation Directory – Specifying the path where Infrastructure components must be installed.
- WebServer Type – Specifying the servlet engine as Tomcat, Websphere, Weblogic or OAS
- Absolute Java Path – Specifying the Java path where the Java executables resides.
- Infrastructure Server Details – Specifying the IP addresses of Application server, Web server, Database components, Database server and SMTP server.
- Database Details – Oracle – Specifying the Config Schema user name, connect string (SID), port and oracle driver path.

The variables under the Layer, ALL needs to be configured mandatorily for all types of installations. All the nodes for this layer are listed in the following sections.

Infrastructure Installation Mode

This node is for the Installation Mode. This can be as Single Tier or Multi Tier.

Following is the code for this node.

```
<InteractionGroup name="Infrastructure Installation Mode">
<!-- Single tier=1 | Multi tier=2 -->
<InteractionVariable name="INSTALLMODE">1</InteractionVariable>
<InteractionGroup>
```

INSTALLMODE variable requests the Installation Mode. You can select either Single Tier or Multi Tier depending on the Infrastructure application architecture you have decided.

For Single Tier, give 1 as parameter.

For Multi Tier, give 2 as parameter.

If Single Tier is selected, all the Infrastructure components (Infrastructure Web components, Infrastructure Application components, and Infrastructure Database components) are installed on one server machine. If Multi Tier is selected, each of the Infrastructure component(s) can be installed on different machines and you can choose the component which you want to install in a particular machine.

Choose Components

This node allows choosing the Infrastructure components to be installed.

Following is the code for this node.

```
<InteractionGroup name="Choose Component(s)">
```

```
<InteractionVariable name="ISAPPSERVER">1</InteractionVariable>
<InteractionVariable name="ISDBSERVER">1</InteractionVariable>
<InteractionVariable name="ISWEBSERVER">1</InteractionVariable>
</InteractionGroup>
```

Select the Infrastructure components that you want to install on the current machine. For Single Tier select all the components.

To select a component enter 1 as the parameter, else enter 0.

Specify Installation Directory

This node allows specifying the path where Infrastructure components must be installed.

Following is the code for this node.

```
<InteractionGroup name="Specify Installation Directory">
<InteractionVariable name=
"User_Install_Dir">/oradata6/revwb7/Oracle</InteractionVariable>
</InteractionGroup>
```

Enter a valid path where all Infrastructure components (Web, Application, and Database Components) are required to be installed.

WebServerType

This node allows specifying the servlet engine as Tomcat, Websphere, Weblogic or Oracle Application Server.

Following is the code for this node.

```
<InteractionGroup name="WebServerType">
<!--TOMCAT = 1 | WEBSHERE = 2 | WEBLOGIC = 3 | OAS = 4 -->
<InteractionVariable name="WEBSERVERTYPE">1</InteractionVariable>
</InteractionGroup>
```

For TOMCAT, give 1 as parameter.

For WEBSHERE, give 2 as parameter.

For WEBLOGIC, give 3 as parameter.

For OAS, give 4 as parameter.

Absolute Java Path

This node allows specifying the Java path where the Java executable files reside.

Following is the code for this node.

```
<InteractionGroup name="Absolute Java Path">
```

```
<InteractionVariable
name="JAVA_BIN">/usr/jdk/instances/jdk1.6.0/bin>1</InteractionVariable>
</InteractionGroup>
```

Enter the absolute path where the Java executable files reside.

Example

For java 32 bit, enter the following `usr/jdk/instances/jdk1.6.0/bin`

Infrastructure Server Details

This node allows specifying the IP addresses of Infrastructure Application server, Web server, Database components, Database server and SMTP server. Following is the code for this node.

```
<InteractionGroup name="Infrastructure Server Details">
<InteractionVariable name="APPSEVER">10.184.74.110</InteractionVariable>
<InteractionVariable name="WEBSERVER">10.184.74.110</InteractionVariable>
<InteractionVariable name="DBCOMP_IP">10.184.74.110</InteractionVariable>
<InteractionVariable name="DBSERVER">10.184.74.61</InteractionVariable>
<InteractionVariable name="SMTPSERVER"></InteractionVariable>
</InteractionGroup>
```

1. Enter the IP Address/hostname of the server under InteractionVariable name APPSEVER, in which the Infrastructure Application components is to be installed.
2. Enter the IP Address/hostname of the server under InteractionVariable name WEBSERVER, in which the Infrastructure WEB components is to be installed.
3. Enter the IP Address/hostname of the server under InteractionVariable name DBCOMP_IP, in which the Infrastructure Database components is to be installed.
4. Enter the IP Address/hostname of the server under InteractionVariable name DBSERVER, in which the Infrastructure Database Server is to be installed.
5. Enter the IP address of the machine on which SMTP service is running in the space provided under InteractionVariable name SMTPSERVER. This is optional and is required only for the mail configuration in the Data Entry Forms and Queries module of Oracle Financial Services Analytical Applications Infrastructure

Database Details – Oracle

This node allows specifying the Oracle user name to be configured as Config Schema, Oracle Instance ID (SID), Port on which database is listening and Oracle JDBC driver path.

Following is the code for this node.

```

<InteractionGroup name="Database Details - Oracle">
<InteractionVariable name="DBUSER">configuser</InteractionVariable>
<InteractionVariable name="SID">OracleSID</InteractionVariable>
<InteractionVariable name="DBPORT">1521</InteractionVariable>
<InteractionVariable
name="ABS_DRIVER_PATH">/<<ORACLE_HOME>>/jdbc/lib</InteractionVariable>
</InteractionGroup>

```

The ABS_DRIVER_PATH refers to the Oracle JDBC driver installed path.

Note: • The absolute driver path should be mentioned.

ORACLE_HOME should point to the Oracle 11g installation path.

Note for Linux platform installation:

ORACLE_HOME should be set to 32-bit Oracle 11g Client installation path. It is required to use the 32-bit Oracle Client libraries even for a 64-bit Linux server.

The Oracle Config Schema user must have all the mentioned privileges in the Pre-installation checklist section of the installation manual.

Layer - APPLICATION

The variables under this layer (LAYER name="APPLICATION") consists of the following nodes which must be configured for installations of Application layer as one of its component.

- Type of Application Server – Specifying the application server as Primary or Secondary server
- Secondary Application Server Details – If secondary application server is selected then javaport and native port details must be specified.
- Infrastructure User Configuration – Specifying the LDAP or SMS authentication.
- Infrastructure LDAP User Configuration – If LDAP is selected then the Root Context and Domain Component elements must be specified.

Type of Application Server

This node allows specify whether the application server is primary or secondary.

Following is the code for this node.

```

<InteractionGroup name="Type of Application Server">
<!-- FIRST_SERVER = 1 | SECONDARY_SERVER = 2 -->

```



```
<InteractionVariable name="APP_SERVER_TYPE">1</InteractionVariable>
</InteractionGroup>
```

If you have already installed an Application Server and this is your secondary Application instance, select the Secondary Application Server Installation option by providing 2 as the value for APP_SERVER_TYPE.

Secondary Application Server Details

If the Secondary application server is selected then you must specify the Javaport and the Native port details.

Following is the code for this node.

```
<InteractionGroup name="Secondary Application Server Details">
<InteractionVariable name="JAVAPORT">13410</InteractionVariable>
<InteractionVariable name="JAVAPORT">13411</InteractionVariable>
</InteractionGroup>
```

Enter the Java Port and Native Port for the Secondary Application Server Instance. The Port Numbers should range from 1025 to 65535.

Infrastructure User Configuration

This node allows specifying the LDAP or SMS user authentication.

Following is the code for this node.

```
<InteractionGroup name="Infrastructure User Configuration">
<!-- USER_LDAP = 1 | USER_SMS = 2 -->
<InteractionVariable name="USERCONFIGURATION">2</InteractionVariable>
</InteractionGroup>
```

This provides you with the option of using LDAP authentication or Infrastructure application authentication for logging on to Oracle Financial Services Analytical Applications Infrastructure.

Choose the type of Infrastructure application user you want to configure. Select the LDAP Users option if you want to use the LDAP authentication for logging on. If LDAP is selected, make sure that the LDAP server is installed and configured.

Refer to Oracle Financial Services Analytical Applications Infrastructure Installation Manual for more information.

If you want to use the Infrastructure application authentication provided by the SMS module, select the Infrastructure application SMS Users option.

For LDAP Users, enter 1 as parameter.

For Infrastructure SMS Users, enter 2 as parameter.

Infrastructure LDAP User Configuration

If the LDAP is selected in the Infrastructure application User Configuration then the Root Context and Domain Component elements in the LDAP user configuration must be specified.

Following is the code for this node.

```
<InteractionGroup name="Infrastructure LDAP User Configuration">
<InteractionVariable
name="LDAP_CONTEXT">dc=OFSAAI,dc=com</InteractionVariable>
<InteractionVariable name="LDAP_DC_NAME">OFSAAI</InteractionVariable>
</InteractionGroup>
```

Enter the Root Context for the LDAP directory in the LDAP Root Context field.

Example

dc=OFSAAI,dc=com

Enter the part of the binding string composed of Domain Component elements which is the DNS domain name (My-Company-Name) in the LDAP DC field.

Example

OFSAAI

Layer - DATABASE

The variables under this layer (LAYER name=" DATABASE") consists of the following nodes which must be configured for installations of DATABASE layer as one of its component

- Infrastructure Universal Content Management – Specifying if Universal Content Management is required for Documentation management.
- WebServer-Context Root - Specifying the Context name for deployment.
- Infrastructure Communicating ports – Specifying the Infrastructure Java port, Infrastructure Native port, Agent port, ICC Object Server port, ICC Native Server port, Servlet port, Message Server port, Router port and the Activation Manager port.
- Infrastructure User Configuration - Specifying the LDAP or SMS authentication.
- Infrastructure LDAP User Configuration - If LDAP is selected then the Root Context and Domain Component elements must be specified.

WebServer-Context Root

Specifies the Context name for deployment. Following is the code for this node.

```

<InteractionGroup name="WebServer-Context Root">
<!-- HTTPS_ENABLE No=0 Yes=1 -->
<InteractionVariable name="CONTEXT_PATH">OFSAAI</InteractionVariable>
<InteractionVariable name="HTTPS_ENABLE">0</InteractionVariable>
</InteractionGroup>

```

Context name will be used in your Application URL.

Example

Context name will be used in your Application URL.

To select HTTPS as Server Protocol provide 1 as the parameter in variable HTTPS_ENABLE, else give 0

Infrastructure Universal Content Management

Applicable if the Oracle Financial Services Analytical Applications Infrastructure license you have acquired includes the Forms Framework module. Following is the code for this node.

```

<InteractionGroup name="Oracle Financial Services Analytical Applications
Infrastructure Universal Content Management">
<!-- Configure Universal Content Management Yes=1 | No=0 -->
<InteractionVariable name="UCM">1</InteractionVariable>
</InteractionGroup>

```

Provide 1 as the parameter in variable UCM (Universal Content Management), if you wish to use Universal Content Server (Oracle Content Server) 10gR3 for Documentation Management, else give 0.

Infrastructure communicating ports

The Infrastructure Java port (JAVAPORT), Infrastructure Native port (NATIVEPORT), Agent port (AGENTPORT), ICC Object port (ICCPORT), ICC Native Server port (ICCNATIVEPORT), Servlet port(SERVLETPORT), Message Server port (MSGPORT), Router port (ROUTERPORT)and the AM port (AMPORT) must be specified. Following is the code for this node.

```

<InteractionGroup name="Infrastructure Communicating ports">
<InteractionVariable name="JAVAPORT">9999</InteractionVariable>
<InteractionVariable name="NATIVEPORT">6666</InteractionVariable>
<InteractionVariable name="AGENTPORT">6510</InteractionVariable>
<InteractionVariable name="ICCPORT">6507</InteractionVariable>
<InteractionVariable name="ICCNATIVEPORTTT">6509</InteractionVariable>
<InteractionVariable name="SERVLETPORT">9080</InteractionVariable>

```

```

<InteractionVariable name="MSGPORT">6501</InteractionVariable>
<InteractionVariable name="ROUTERPORT">6500</InteractionVariable>
<InteractionVariable name="AMPORT">6505</InteractionVariable>
</InteractionGroup>

```

Enter the desired port numbers against the InteractionVariable for which you want to change the port numbers.

The Port Numbers should range from 1025 to 65535. (The default port for Websphere / Tomcat / Weblogic is 9080 / 8080 / 7001).

You can choose to perform port changes as a post installation activity. Refer the Configuration of Ports section in the Oracle Financial Services Analytical Applications Infrastructure Installation Manual for more details.

Infrastructure User Configuration

This node is to specify the LDAP or SMS configuration.

Following is the code for this node.

```

<InteractionGroup name="Infrastructure User Configuration">
<!-- USER_LDAP = 1 | USER_SMS = 2 -->
<InteractionVariable name="USERCONFIGURATION">2</InteractionVariable>
</InteractionGroup>

```

OFSAAI provides you with the option of using LDAP authentication or OFSAAI authentication for logging on to OFSAAI.

Choose the type of OFSAAI user you want to configure. Select the LDAP Users option if you want to use the LDAP authentication for logging on. If LDAP is selected, make sure that the LDAP server is installed and configured. Refer to the Installation Manual for more information.

If you want to use the OFSAAI authentication provided by the SMS module of Oracle Financial Services Analytical Applications Infrastructure, select the OFSAAI SMS Users option.

For LDAP Users, enter 1 as parameter.

For Infrastructure SMS Users, enter 2 as parameter.

Infrastructure LDAP User Configuration

If the LDAP is selected in the Oracle Financial Services Analytical Applications Infrastructure User Configuration then the Root Context and Domain Component elements in the LDAP user configuration must be specified. Following is the code for this node.

```

<InteractionGroup name="Infrastructure LDAP User Configuration">
<InteractionVariable

```

```
name="LDAP_CONTEXT">dc=OFSAAI,dc=com</InteractionVariable>
<InteractionVariable name="LDAP_DC_NAME">OFSAAI</InteractionVariable>
</InteractionGroup>
```

Enter the Root Context for the LDAP directory in the LDAP Root Context field.

Example

```
dc=OFSAAI,dc=com
```

Enter the part of the binding string composed of Domain Component elements which is the DNS domain name (My-Company-Name) in the LDAP DC field.

Example

```
OFSAAI
```

Layer - WEB

The variables under this layer (LAYER name=" WEB") consists of following nodes which must be configured for installations of WEB layer as one of its component.

- Infrastructure Universal Content Management – Specifying if Universal Content Management is required for Documentation management.
- Infrastructure Web Services – Specify if the web services needs to be configured.
- Explorer Proxy Details - If Yes option is selected in the Oracle Financial Services Analytical Applications Infrastructure Web Services, then configure the explorer proxy details.
- Infrastructure Content Management Settings - Required to be configured with Oracle Financial Services Analytical Applications Infrastructure Content Management details if the OFSAAI license does not include the Forms Framework module.
- Universal Content Management Settings - Required to be configured if the OFSAAI license includes the Forms Framework module. Make sure that Apache Web Server 2.2.4 and Universal Content Server (Oracle Content Server) 10gR3 is installed in the same Windows server.
- Infrastructure Setup - WEBSERVER PATH – Specifying the Application Deployment Path under the selected Webserver.
- Weblogic Setup Details – Specifying the WebLogic Domain Home Path.

Installing Secondary Application Server

Introduction

Since Infrastructure Application Server instances can be distributed across different machines, it is possible to install a Secondary Application Server instance.

Refer to the Distributed Infrastructure Application Server section for more information about the distributed application server instances.

Procedure

1. For installing a Secondary Application Server instance, start the Infrastructure installation and in the Infrastructure Installation Mode screen, select the Multi Tier option.
2. Select the Application Components option in the Choose Component(s) screen.
3. The Type of Application Server screen is displayed. If you have already installed an Application Server and this is your secondary Application instance, select the Secondary Application Server Installation option and click Next to continue.
4. Click the Help button in the Infrastructure Installation screens to view the instructions specific to the screens.
5. On successful installation of Infrastructure Application component, the Installation Complete screen is displayed. Click Done to close the installer window.

Configuring the Servlet Engine

WebSphere Configuration

The servlet engine required by the Infrastructure application is WebSphere 7.0.0.5. As stated in the section Software Environment earlier, the servlet engine is expected to be installed on the machine identified as the Infrastructure Web Server. Instructions on configuring WebSphere are given in this section.

WebSphere Enterprise ARchive Files Creation

File Creation

The Enterprise ARchive (EAR) files is required to assemble servlets, .jsp files, web pages and other static content into a deployable unit. This EAR file creation is required to reflect the changes made to the web.xml file.

Following are the outlined steps:

1. On the machine in which Infrastructure Web components have been installed, navigate to the \$FIC_WEB_HOME directory. At the prompt type ./ant.sh. This will trigger the creation of EAR file - <contextname>.ear.

Note: <contextname> is the context name given during installation.

2. On completion of the EAR files creation, the following message will be displayed and you will be returned to the prompt.

BUILD SUCCESSFUL

Time taken

3. The EAR file - <contextname>.ear - is created on the machine on which Infrastructure Web components are installed under \$FIC_WEB_HOME directory.

Note: This process overwrites any existing version of EAR file that exists in the path.

WebSphere EAR Files Deployment

This step is for deploying Infrastructure application in WebSphere.

Files Deployment

1. Open the URL in the browser window: `http://<ipaddress>:<Administrative Console Port>/ibm/console`. The login screen is displayed. Login with the user id that has admin rights.

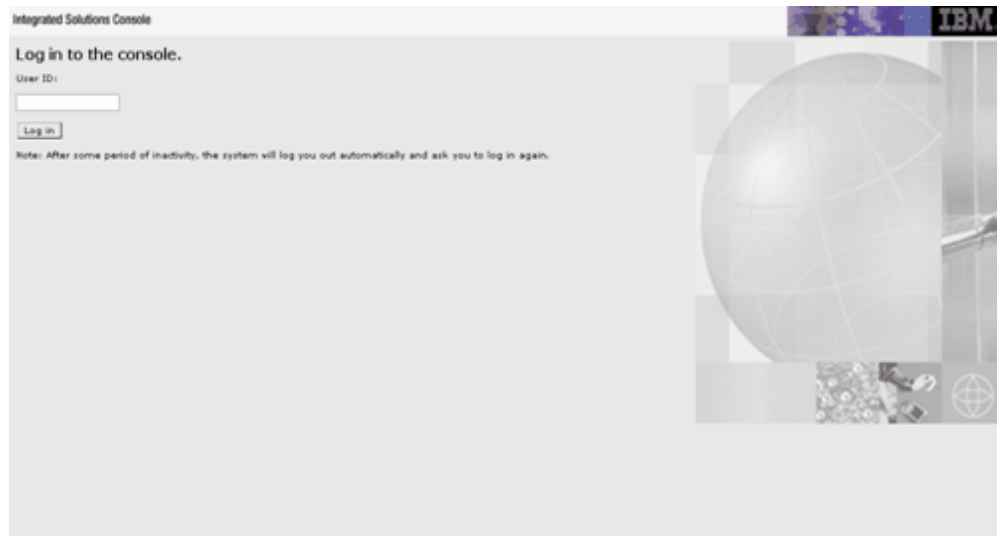

2. Expand Applications > New Application > The New Applications window opens. Select New Enterprise Application option.



3. It will take you to the Preparing for the application installation page as shown in the following figure.

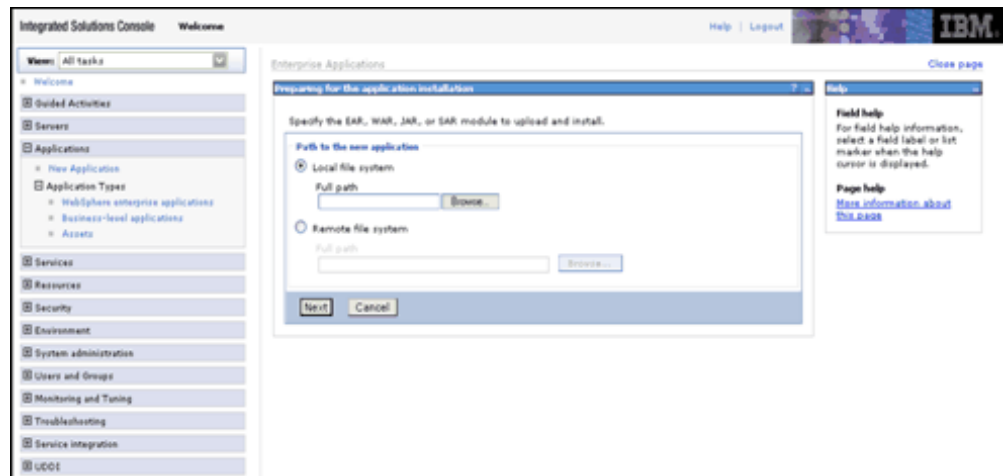

4. Select the remote file system and Click Browse to select the EAR file which is generated for OFSAAI to upload and install. This file name will be displayed in the Specify Path box provided. Click Next.

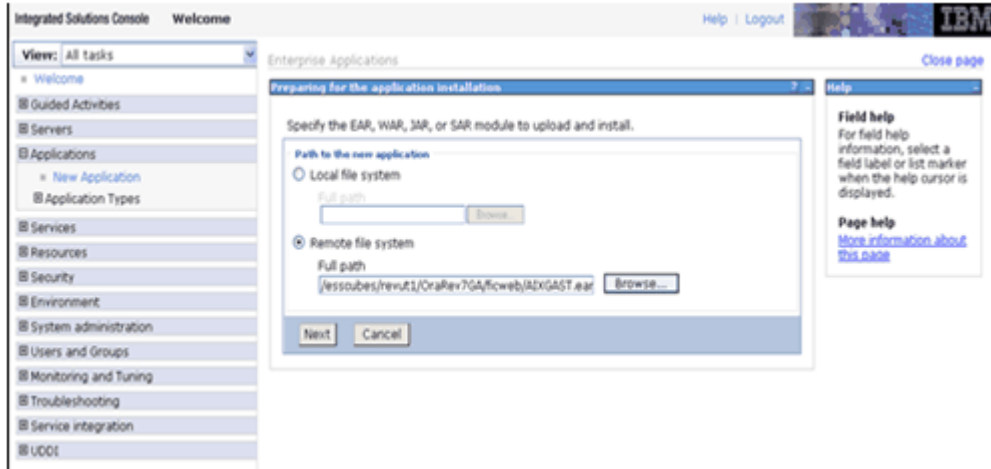

5. Chose the Fast path from the options available and click Next.

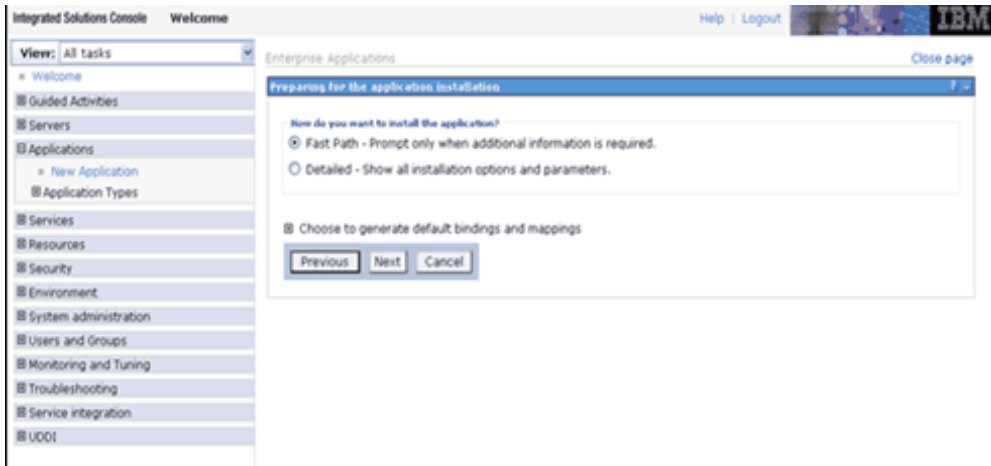

6. The select Installation page is displayed. Click Next

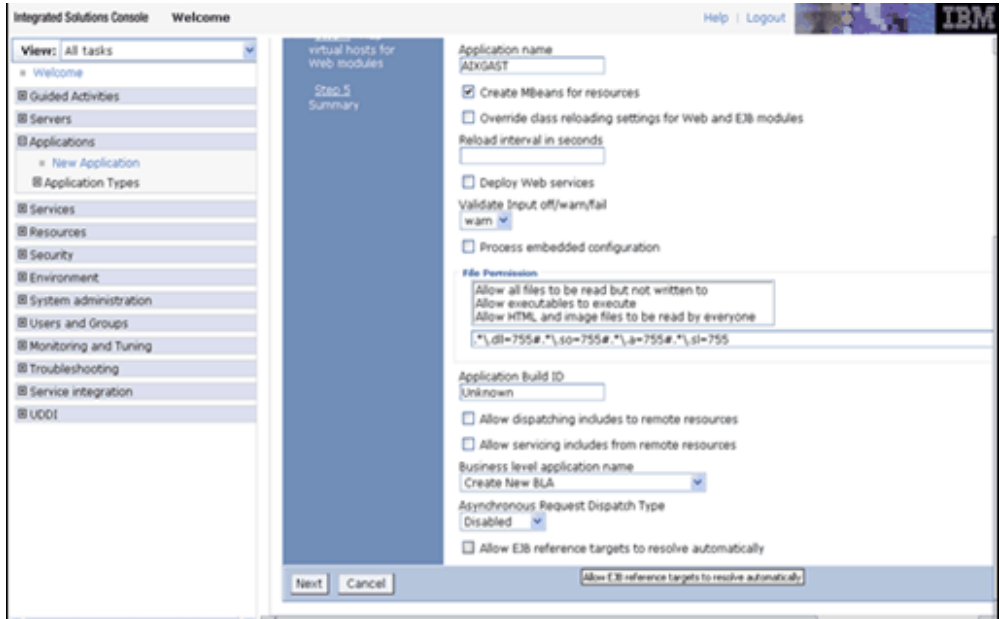

7. In the Map the modules to servers page select the Web Application and click Next

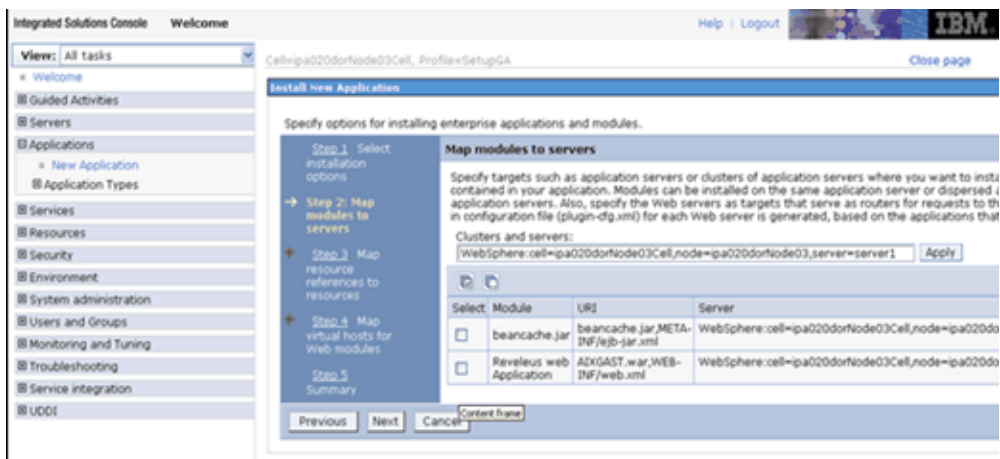

8. The Map resource references to resources page are displayed. Map each resource defined in your application to a resource JNDI name defined earlier.

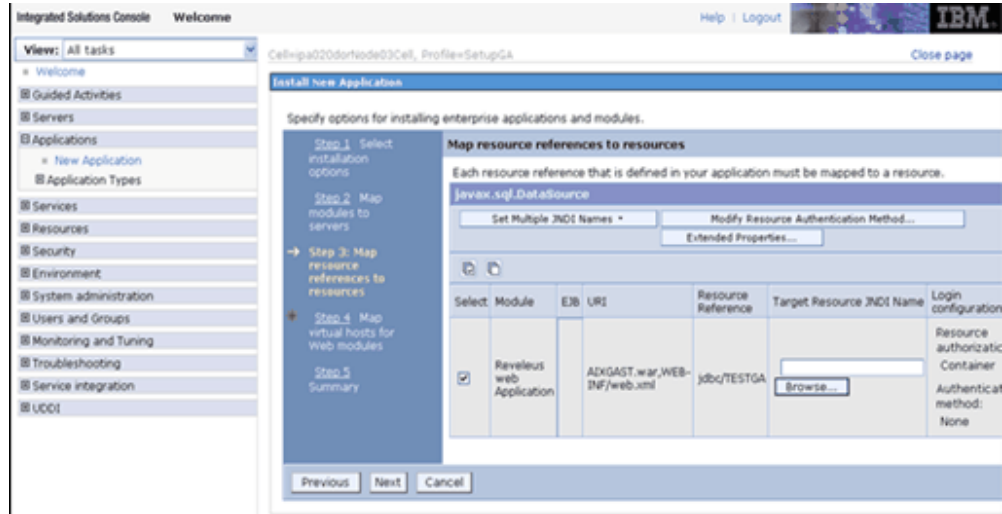

- After mapping the resource reference, click on "Modify Resource Authentication Method" option available. Specify the authentication method created earlier.

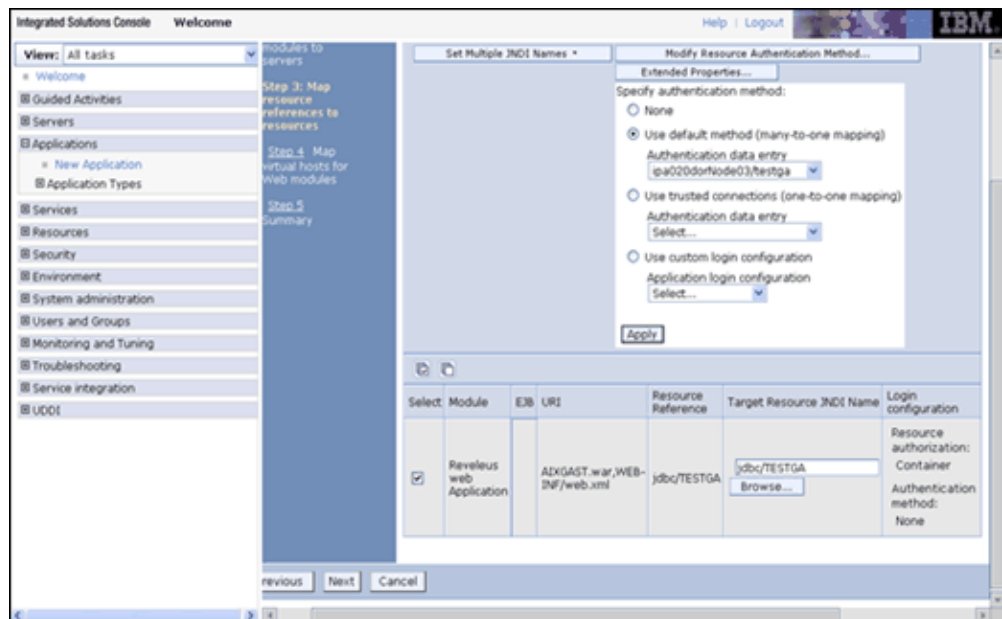

- Select the Web Application check box and Click Next

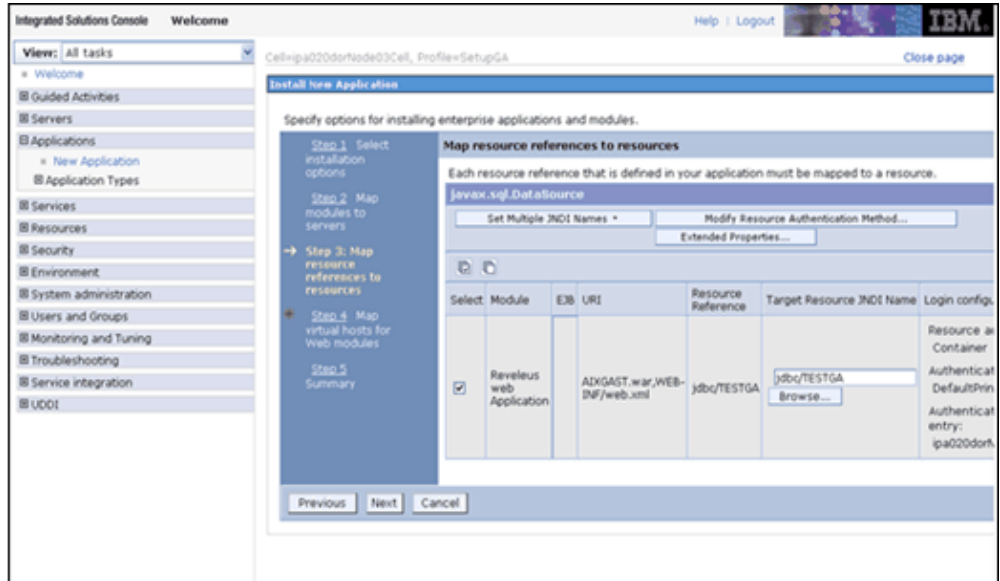

11. The Map Virtual hosts for Web Modules screen is displayed. Select the Web Application check box and Click Next

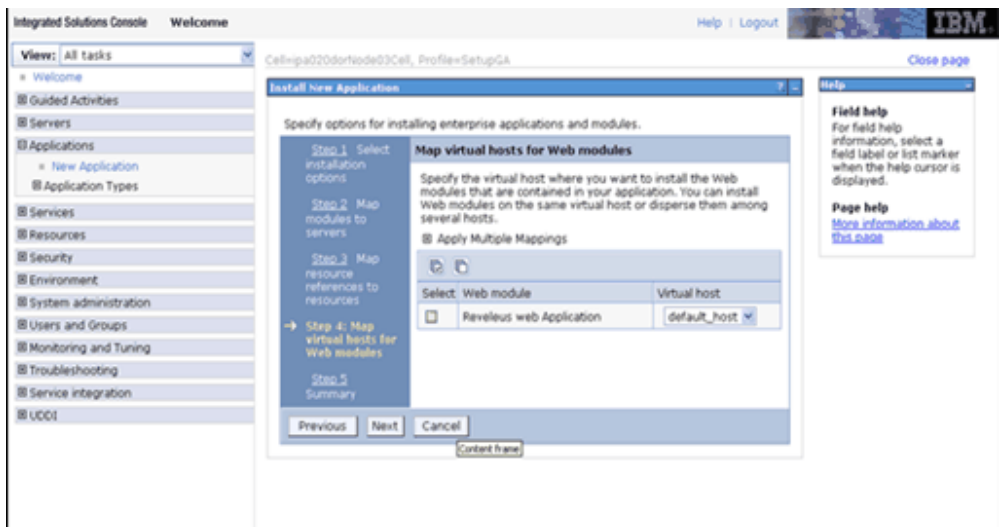

12. The summary page is displayed. Check the same and Click Finish.

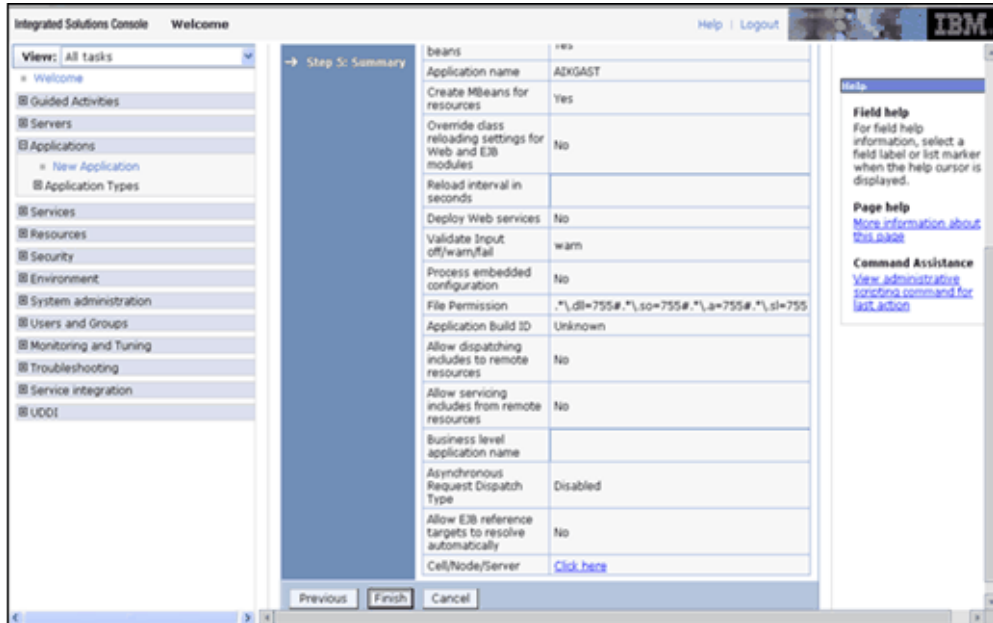

- This will deploy the Infrastructure Application on WebSphere. Once the installation is successful message appears, Click Save to save the master file configuration.



- To start the application, Expand Applications > Application Type > WebSphere enterprise applications. The Enterprise Applications window opens. Select the application installed and click on Start.

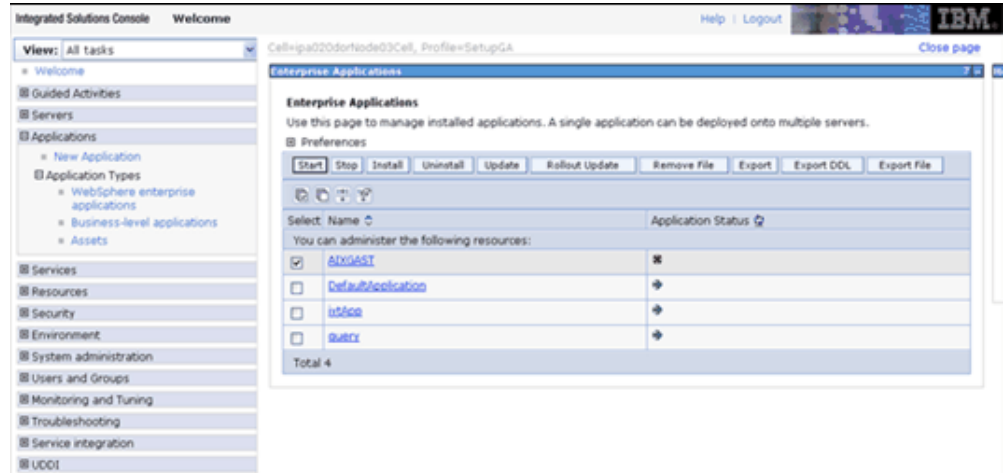

- <profile name> is the profile name given while creating the WebSphere profile. Refer to WebSphere Configuration for Infrastructure Application Deployment section for details.
- <cell name > is the cell name given during profile creation
- <contextname> is the context name given during installation.

WebSphere HTTPS Configuration

Ensure the below steps for Configuring an HTTPS Transport on Websphere.

1. Create a profile using the Profile Creation Wizard in WebSphere.
2. Note down the https port specified during this process and use the same as servlet port or web server port during OFSAAI Installation.
3. Enable the checkbox for https during OFSAAI installation to enable https configuration on Infrastructure.

Tomcat Configuration

Tomcat Configuration

Note: This section is applicable if the web container is Tomcat

The servlet engine required by the Infrastructure application is Tomcat. As stated in the section Software Environment under chapter Pre-Installation, the servlet engine is expected to be installed on the machine identified as the Infrastructure Web Server.

Instructions on configuring Tomcat are given in this section.

Tomcat User Administration

The Tomcat administration and manager application does not provide a default login. You are required to edit `$CATALINA_HOME/conf/tomcat-users.xml` as instructed below.

This file contains an XML `<user>` for each individual user, which will display the username and password used by admin to log into Tomcat, and the role names admin user is associated with.

Example

```
<user name="admin" password="admin" roles="standard,manager" >
```

Add the manager role to any one of the existing username/password combination as shown in the example above.

Use the same username/password to which the manager role has been assigned to access the Tomcat Application Manager.

If the Tomcat server is already running, it requires a re-start after the above configuration is done.

Configuring Tomcat to use the JAVA 32 bit Executables

The section is only required if installing on a 64-bit OS. If the 32 bit JDK was used for a 32-bit OS, this step is not required.

Navigate to the `$CATALINA_HOME/bin` folder.

Edit the `setclasspath.sh` as explained below:

Under 'Set standard commands for invoking Java', change `"$JAVA_HOME"/bin` to `"$JAVA_BIN"`.

Example

Edit the following block of text:

```
# Set standard commands for invoking Java.
```

```
_RUNJAVA="$JAVA_HOME"/bin/java
```

```
_RUNJDB="$JAVA_HOME"/bin/jdb
```

```
_RUNJAVAC="$JAVA_HOME"/bin/javac
```

Change it to:

```
_RUNJAVA="$JAVA_BIN"/java
```

```
_RUNJDB="$JAVA_BIN"/jdb
```

```
_RUNJAVAC="$JAVA_BIN"/javac
```

If the Tomcat server is already running, it requires a re-start after the above configuration is done.

Servlet Port Configuration

The Servlet Port specified during the Infrastructure installation process must be configured in Tomcat if your web server is Tomcat. If you are using the default port (8080), then you are not required to configure the same since it is already configured.

If you are using a different port number, you must first configure the port in the server.xml in the conf directory of Tomcat Installation directory. The following steps guide you through the configuration process.

Navigate to \$CATALINA_HOME/conf. Open server.xml and locate the tag:

"Define a non-SSL HTTP/1.1 Connector on port 8080"

Against this tag, a parameter is specified 'Connector port = "8080"'. Edit this value to the new port number that was used during the Infrastructure installation process.

Save your changes in server.xml.

Tomcat WAR Files Creation

The WAR files is required to assemble servlets, .jsp files, web pages and other static content into a deployable unit.

The steps given below will guide you through the WAR files creation process.

1. On the machine in which Infrastructure Web components have been installed, navigate to the path \$FIC_WEB_HOME.
2. At the prompt, execute ant.sh. This will trigger the creation of WAR file - <context-name>.war

Note: <context-name> is the context name given during installation.

3. On completion of the WAR files creation, a confirmation message will be displayed and you will be returned to the prompt.
4. The WAR file - <context-name>.war. - is created on the machine on which Infrastructure Web components are installed under \$FIC_WEB_HOME directory.

Note: • This process overwrites any existing version of WAR file that exists in the path. Proceed with the following steps for Tomcat WAR Files Deployment.

- Log on to the server in which Tomcat is installed.

Now, proceed to the Tomcat WAR Files Deployment section.

Tomcat WAR Files Deployment

Before deploying the WAR files, ensure that the previously deployed applications of Infrastructure are uninstalled.

Refer to Uninstalling Previously Deployed WAR Files in Tomcat for the procedure to uninstall the previously deployed Infrastructure war files

On the machine that hosts Tomcat, follow the steps outlined to deploy Infrastructure application.

1. Open the URL in Browser window: `http://<IP address>:<Tomcat server port>`. The Tomcat home page is displayed. Click the 'Tomcat Manager' link on the LHS menu. Login with the user id that has admin rights. (For user creation in tomcat, refer to the section Tomcat User Administration
2. This takes you to the Tomcat Web Application Manager. This displays all the applications deployed in Tomcat.
3. Enter the context name given during the installation under Deploy Context Path field as `/<context-name>`.
4. Enter the Path where the `<context-name>.war` file resides (by default `$FIC_WEB_HOME/<context-name>.war`) in the WAR or Directory URL and click on Deploy

<code>/docs</code>	Tomcat Documentation	true	0	Expire sessions with idle > 30 minutes
<code>/examples</code>	Servlet and JSP Examples	true	0	Start Stop Reload Undeploy Expire sessions with idle > 30 minutes
<code>/host-manager</code>	Tomcat Manager Application	true	0	Start Stop Reload Undeploy Expire sessions with idle > 30 minutes
<code>/manager</code>	Tomcat Manager Application	true	0	Start Stop Reload Undeploy Expire sessions with idle > 30 minutes
<code>/ofsaapq</code>	Revelex web Application	true	1	Start Stop Reload Undeploy

Deploy

Deploy directory or WAR file located on server

Context Path (required):

XML Configuration file URL:

WAR or Directory URL:

WAR file to deploy

Select WAR file to upload

Server Information

Tomcat Version	JVM Version	JVM Vendor	OS Name	OS Version	OS Architecture
Apache Tomcat/8.0.28	ppc3260wrs-20090629_04 (SR6)	IBM Corporation	AIX	5.3	ppc

Copyright © 1999-2005, Apache Software Foundation

5. Upon successful deployment of the application the following confirmation message is displayed.

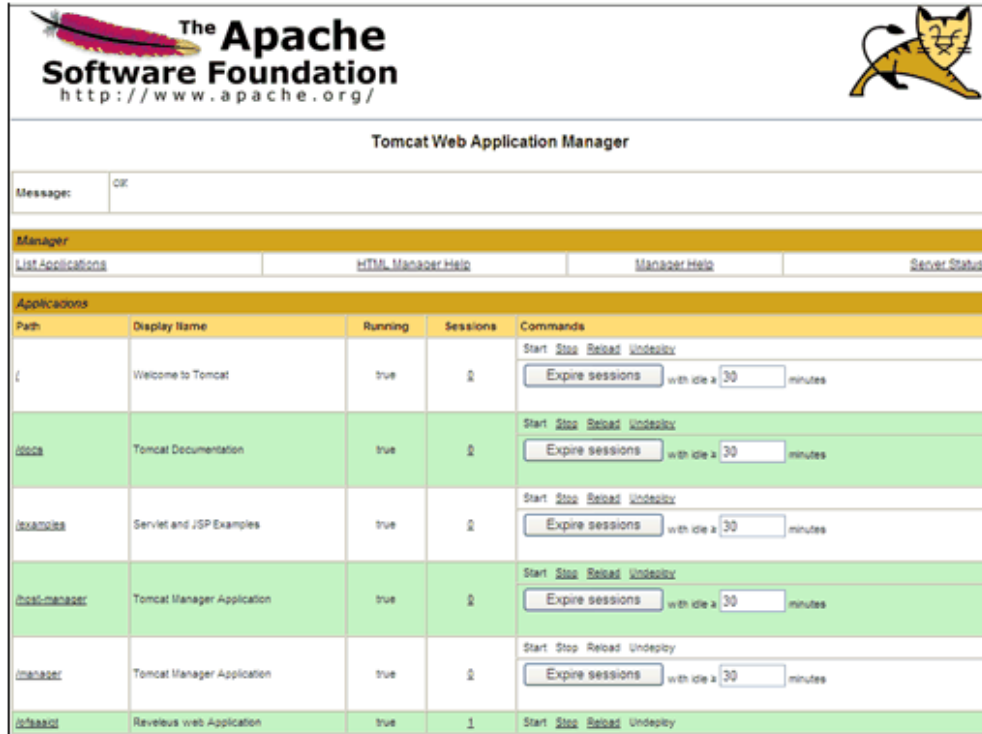

Refer to the Starting Infrastructure section for information on starting the Tomcat server.

Non SSL Port Configuration

Ensure that the following connect tag under "Define a non-SSL HTTP/1.1 Connector on port 8080" in <Tomcat_installation_folder>/conf/server.xml file is uncommented for Non-SSL Configuration. (By default, it is uncommented.)

```
<Connector port="8080" protocol="HTTP/1.1"
connectionTimeout="20000"
redirectPort="8443" />
```

<! Note: To disable connection timeouts, set connectionTimeout value to -1-->

Note: • The port mentioned as connector port is the Web server port or servlet port in Infrastructure.

SSL Port Configuration

Ensure that the following connect tag under "Define a SSL HTTP/1/1 Connector on port 8443" in <Tomcat_installation_folder>/conf/server.xml file is uncommented for SSL Configuration. (By default, it is commented.)

```
<Connector port="8443" protocol="HTTP/1.1" SSLEnabled="true"
maxThreads="150" scheme="https" secure="true"
clientAuth="false" sslProtocol="TLS"
```

Note: • The port mentioned as connector port is the Web server port or servlet port in Infrastructure.

• For more information related to SSL Configuration on Tomcat, please see <http://tomcat.apache.org/>

WebLogic Configuration

The servlet engine is expected to be installed on the machine identified as the Infrastructure Web Server. Instructions on configuring WebLogic are given in this section.

Note: If WebLogic is installed on a remote machine, then you must perform certain post-installation steps manually as stated in WebLogic EAR Files Deployment, page 9-16.

WebLogic EAR Files Creation

File Creation

The Enterprise ARchive (EAR) files is required to assemble servlets, .jsp files, web pages and other static content into a deployable unit. This EAR file creation is required to reflect the changes made to the web.xml file.

Following are the outlined steps:

1. On the machine in which Infrastructure Web components have been installed, navigate to the \$FIC_WEB_HOME directory. At the prompt type `./ant.sh`. This will trigger the creation of EAR file - `<contextname>.ear`.

Note: `<contextname>` is the context name given during installation.

2. On completion of the EAR files creation, the following message will be displayed and you will be returned to the prompt.

BUILD SUCCESSFUL

Time taken

3. The EAR file - `<contextname>.ear` - is created on the machine on which

Infrastructure Web components are installed under \$FIC_WEB_HOME directory.

Note: This process overwrites any existing version of EAR file that exists in the path.

WebLogic EAR Files Deployment

The steps for deploying Infrastructure application in WebLogic is given below.

On the machine in which WebLogic is installed, navigate to <WebLogic Installation directory>/user_projects/domains/<domain name>/</bin and execute startWebLogic.sh -d64 file to start WebLogic.

Open the URL in the browser window: http://<ipaddress>:<admin server port>/console. The Sign in screen of the WebLogic Server Administration Console is displayed.

Sign on with the WebLogic user name and password having privileges to deploy the EAR file.

From the left hand screen menu, under Domain Structure, click Deployments.

The '**Summary of Deployments**' screen appears. Click Install.

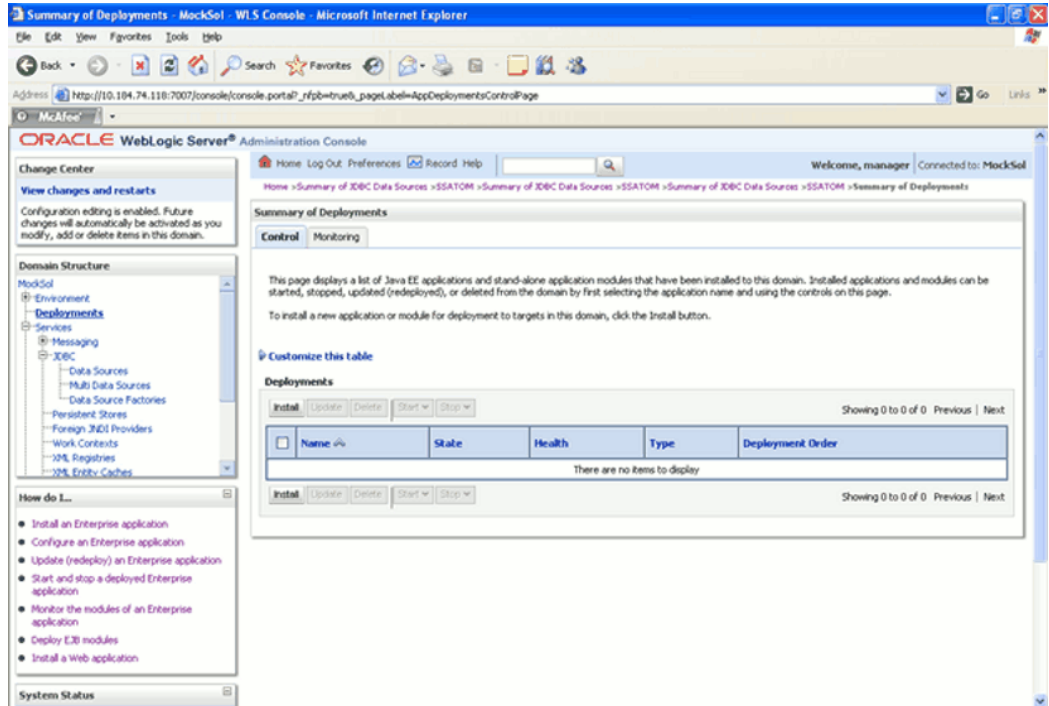

1. The Install Application Assistant screen is displayed. Select the 'exploded EAR' directory after browsing to the directory where it is saved. Click Next.

To explode EAR, follow the below steps.

- Create the 'applications' folder under domain name.
/Bea/user_projects/domains/<Domain_name>/applications.
- Create <context_name>.ear file under 'applications' folder. Copy the <\$FIC_WEB_HOME/<context_name>.ear file to <WEBLOGIC_INSTALL_DIR>/Bea/user_projects/domains/<DOMAIN_NAME>/applications/<context_name>.ear
- Explode the <context_name>.ear file using the command `jar -xvf <context_name>.ear`
- Delete the <context>.ear and <context>.war file(recently created).
- Create a directory <context_name>.war under <WEBLOGIC_INSTALL_DIR>/Bea/user_projects/domains/<DOMAIN_NAME>/applications/<context_name>.ear
- Copy <\$FIC_WEB_HOME/<context_name>.war file to <WEBLOGIC_INSTALL_DIR>/Bea/user_projects/domains/<DOMAIN_NAME>/applications/<context_name>.ear/<context_name>.war

- Explode the <context_name>.war file using the command `jar -xvf <context_name>.war` to get the directory structure.

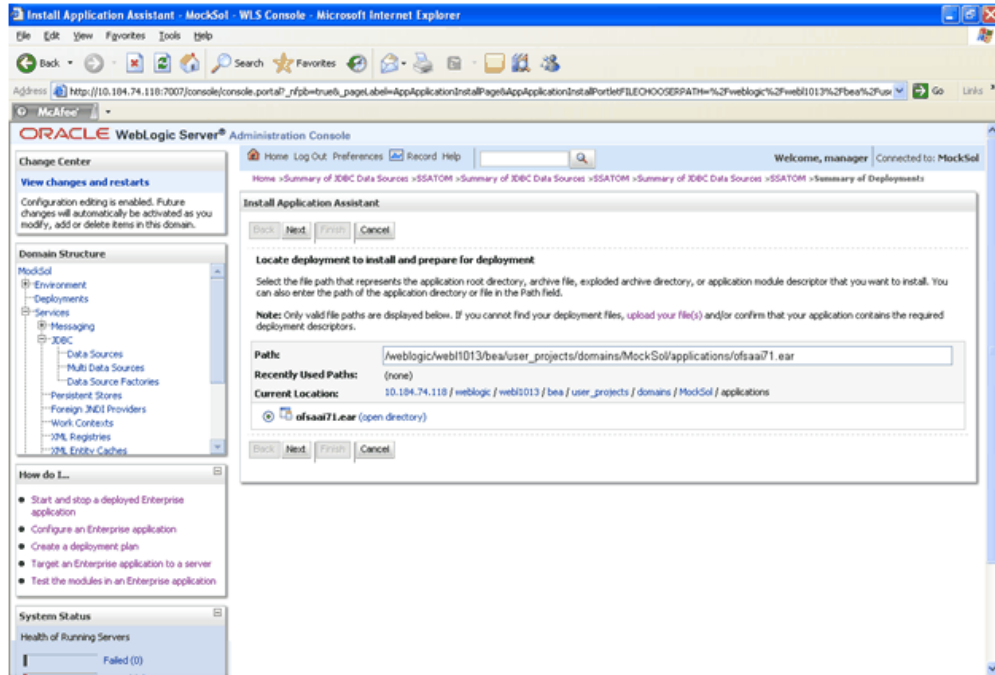

2. In the 'Choose targeting style' screen, select the 'Install this deployment as an application' and click Next.

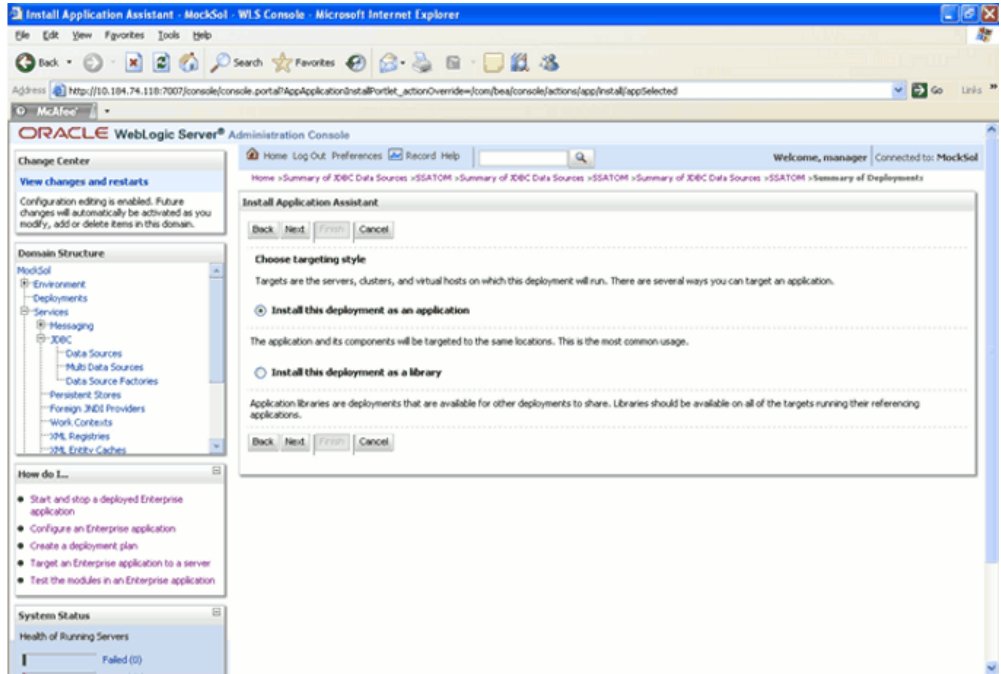

3. The 'Optional Settings' screen is displayed. If required, enter a name for the deployment in the Name field. Select the 'DD only' option to specify that only roles and policies that are defined in the deployment descriptors should be used. Also, select the 'I will make the deployment available from the following location' option under Source accessibility. Click Next to continue.

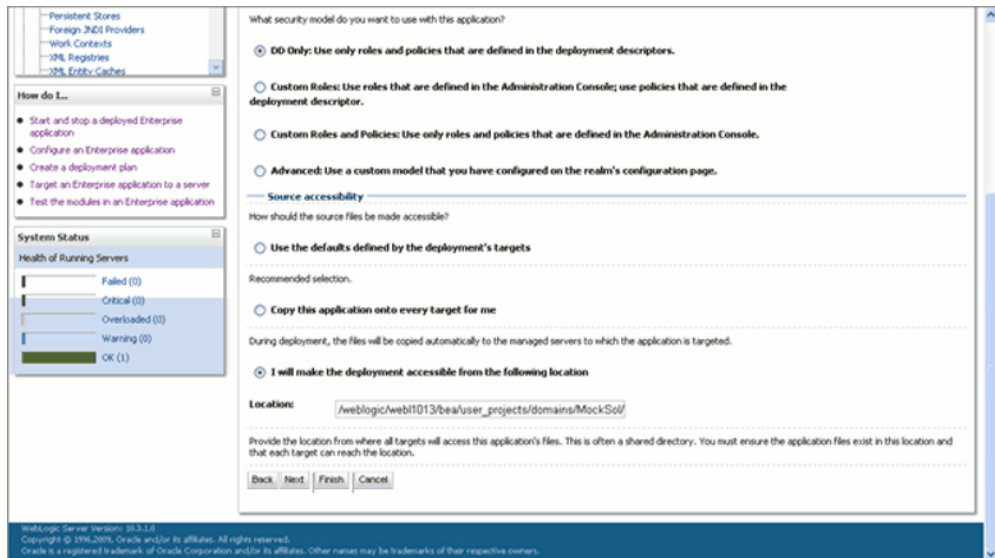
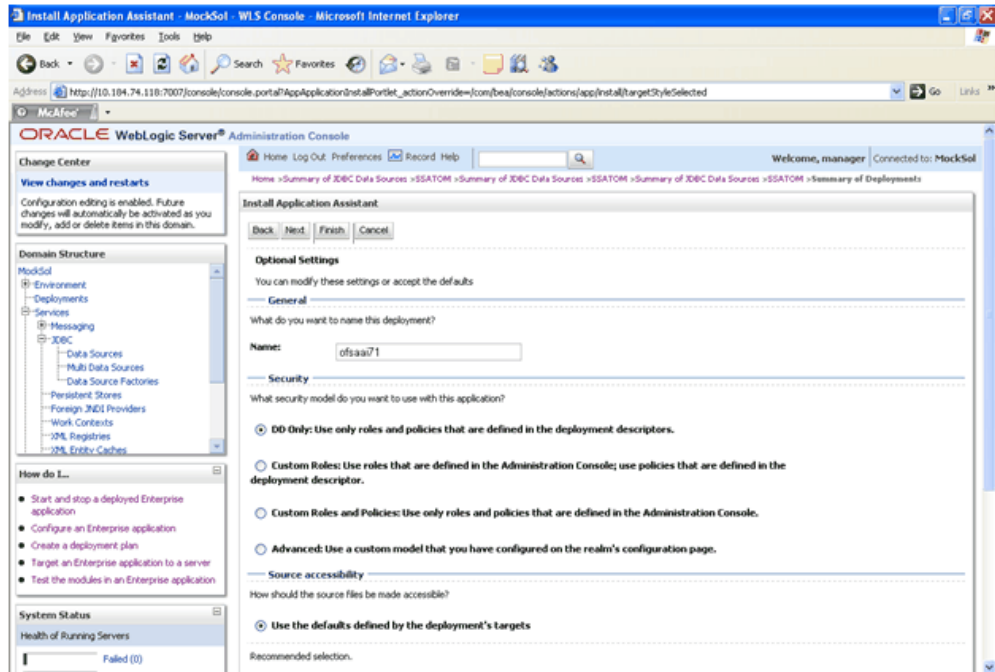

4. The 'deployment summary' is displayed. Select the 'Yes, take me to the deployment's configuration screen' option and click Finish.

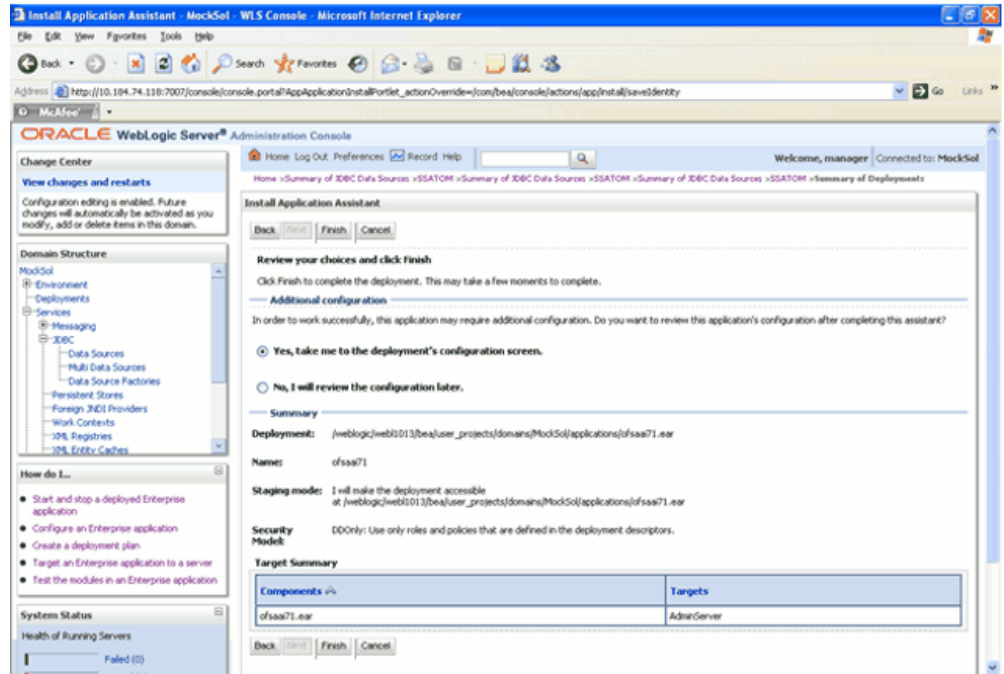

5. In the Settings for <Deployment Name> screen, review the general configuration details of the deployment. You can update the configuration of the deployment in this screen. Click Save to save the updates, if any.

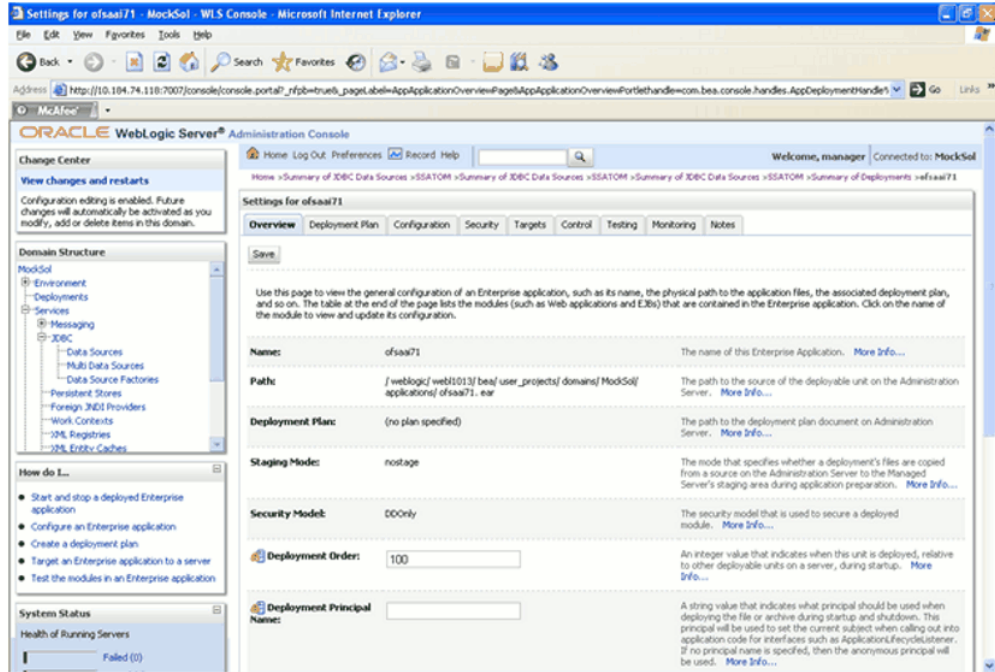

6. Click the 'Overview' tab to view the complete configuration of the deployment.

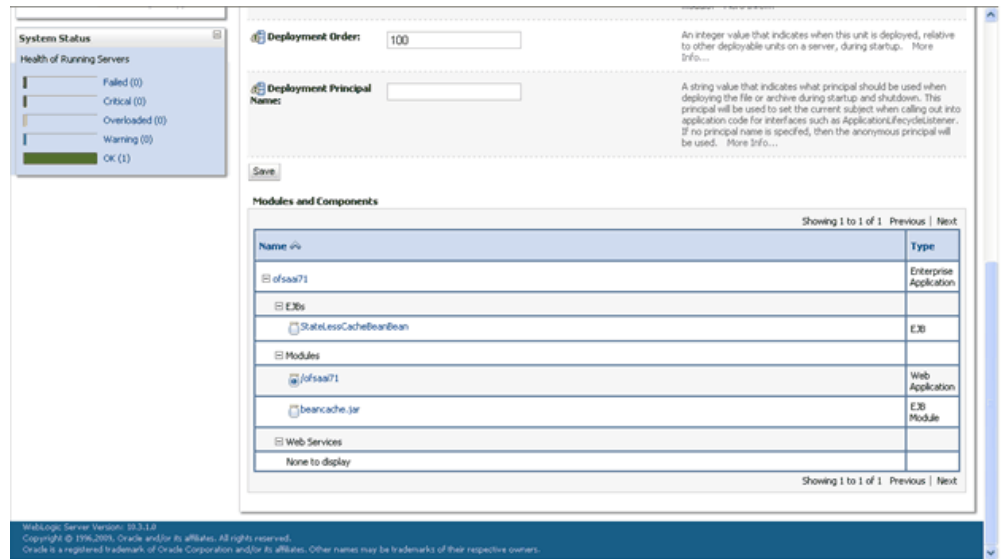
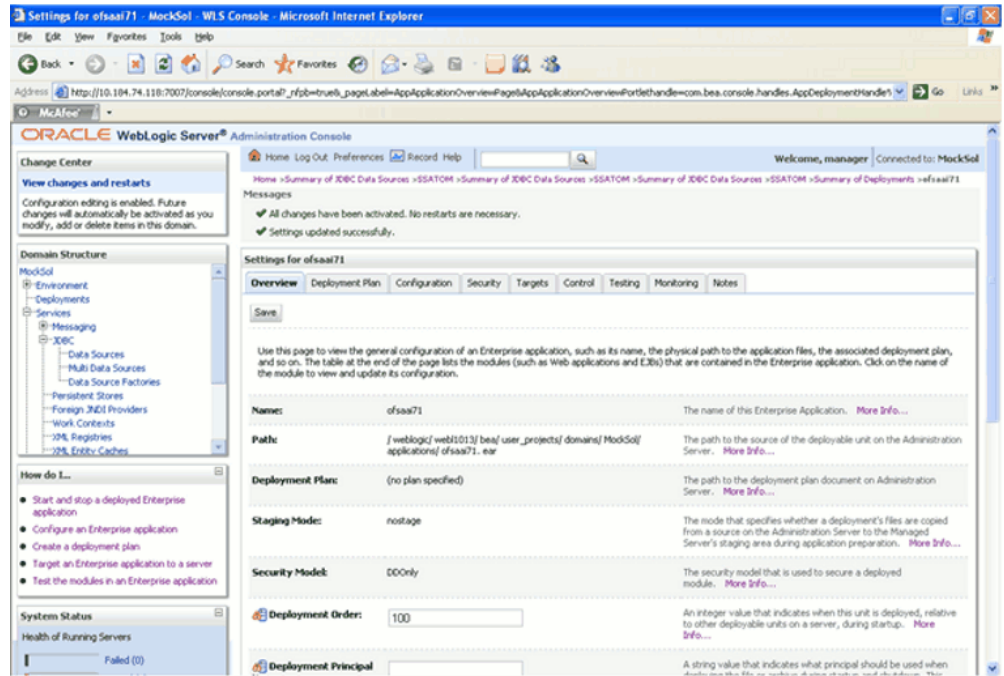

- In the LHS menu, click Deployments. Select the newly deployed Infrastructure application and click Start > Servicing all requests (The Infrastructure server should be up and running).

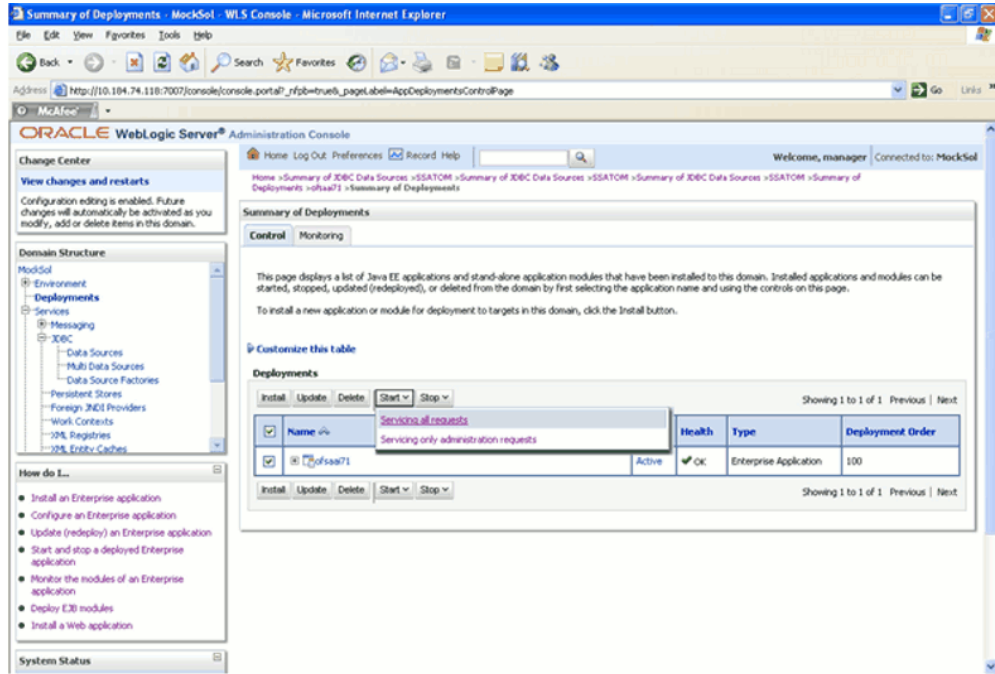

- The following screen will confirm that the application has been started. The State of the deployed application will be displayed as Active if started successfully.

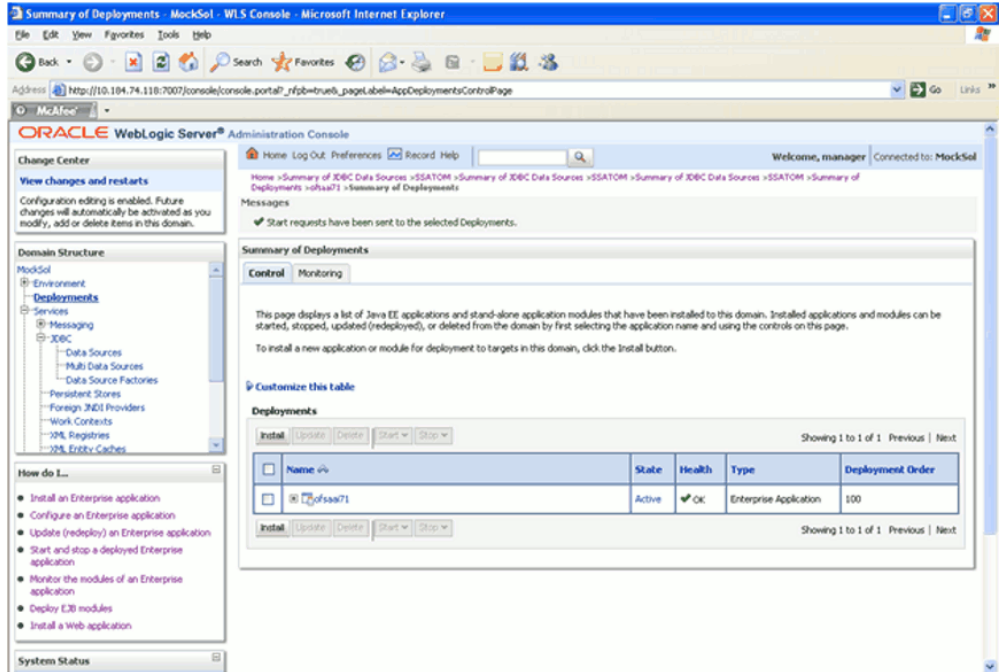

For more information on Deploying WebLogic Server Applications, refer to <http://e-docs.bea.com/wls/docs81/deployment/overview.html>.

Post Infrastructure Installation Activities

Introduction

Once the Infrastructure installation is completed successfully, certain post-installation steps are required to set configuration parameters. These configuration parameters are distributed across the machines on which Infrastructure Web; Application and Database components have been installed.

Configuring the libcpptriples.so File

For WebSphere

Copy the libcpptriples.so file from \$FIC_WEB_HOME/bin to <WebSphere installation path>/AppServer/bin.

Example: /websphere/ibm/AppServer/bin

For WebLogic

Copy libcpptriples.so and libstlport.so.1 files from \$FIC_WEB_HOME/bin to <WebLogic Server Home>/server/native/solaris/sparc64

Example: /weblogic/web11013/bea/wlserver_10.3/server/native/solaris/sparc64

Note: libcpptriples.so configuration is required only if the web container is websphere/weblogic.

Infrastructure Server Memory Configuration

The Infrastructure Application Server is started using revevusstartup.sh. This file can be edited for setting customized memory settings, garbage collector settings depending on the available hardware configuration. You are requested to contact Infrastructure Support for guidance in altering the memory settings.

Configuring XVFB

XVFB is an OS level file set which gets installed during the installation of the AIX Operating System. XVFB is required for the functioning of the Export option in OFSAAI.

Steps for configuring XVFB on AIX:

1. Log on to the server as a user with administrative privileges.
2. Start the XVFB service from the /user/bin/X11 directory.
3. Execute the following command from the /user/bin/X11 directory.

```
X -force -vfb -x abx -x dbe -x GLX :n &
```

In the above command, the value of 'n' can be given as 0 or 1.
4. In startServer.sh file of WebSphere in <WebSphere Installation Directory>/AppServer/bin, set the Display variable 'export DISPLAY' as "IP Address of the AIX machine where the servlet engine is hosted" and save the .profile.

Example

```
export DISPLAY="10.2.221.196:0.0"
```

5. In OFSAAI Application server .profile of the user, set the DISPLAY Variable as the "IP Address of the AIX machine where the OFSAAI Application Server is hosted" and save and run the .profile file.

Example

```
export DISPLAY="10.2.221.196:0.0"
```

6. Restart the WebSphere default profile by executing in <WebSphere Installation Directory>/AppServer/bin/startServer.sh and execute the .profile of the OFSAAI Application Server.
7. Verify that the DISPLAY Variable is set to the IP address of the AIX machines respectively.

Example

```
/home/<user> echo $DISPLAY
```

```
10.2.221.196:0.0
```

10.2.221.196:0.0 is the IP Address of the respective AIX machine.

OLAP Data Server Configuration

The following parameters must be set so as to ensure that the system limitations are not

exceeded at any stage during the life of an instance of OLAP Data Server. The values for these OS parameters should be specified based on the expected load at each implementation site.

Example

Process Memory Limit

Max Thread Stack Size

Max Number of Threads per Process

You are requested to contact OFSAAI Support for guidance in altering the above settings.

Sort Buffer setting must be set at the Essbase application level appropriate to the anticipated load.

Note: Hyperion Essbase is required only if you are using the OLAP feature of OFSAAI.

Configuration for User Attributes Screen

The User Attributes feature of Infrastructure allows you to enter additional attributes for a user. The CSSMS_ATTRIB_MAST table in the Config schema should be loaded with data based on the additional attributes that are required to be captured for a user. The field labels in the User Attributes screen of Infrastructure will be dependent on the values that are entered in this table.

The Infrastructure User Attributes screen asks for these details during Infrastructure installation. If you wish to do these activities as a post installation steps, use the following details for your reference.

Following is an example of the data to be loaded in the CSSMS_ATTRIB_MAST table:

CSSMS_ATTRIB_MAST table

ATTRIBUTE_ID	ATTRIBUTE_DESC	ALLOWED_VALUES	TYPE
PH	Phone Number		0
HT	Home town	Bangalore, Mumbai,Delhi,Chennai	1
MGR	Manager	select case when v_usr_id =' [<USER>]' then 'null' else v_usr_id end,v_usr_name from cssms_usr_profile	2

Here, ALLOWED_VALUES column holds the values that can be specified for the

attribute and TYPE specifies how to get the allowed values.

The values that can be specified in the TYPE column are as follows:

- 0 – USER INPUT
- 1 – Comma Separated Values
- 2 – Execute the SQL select query in ALLOWED_VALUES column to get the list of allowed values. The query should select two columns, the first of which will be the actual values and the second, the description which will be displayed in the select list.

[<USER>] should be replaced with a valid Infrastructure user id.

Configuration of Infrastructure Ports

This step is applicable only in the event you wish to change any of the ports used by Infrastructure services after the installation process. The ports that are used by the Infrastructure application are distributed across the machines on which Infrastructure Web; Application and Database components have been installed. Therefore you must perform the port changes on all the machines on which Infrastructure components have been installed. On each machine, navigate to the path \$FIC_HOME. Enter the command `java -jar PortC.jar`.

The current Ports Definition can be found in the \$FIC_HOME/PortsDef.log.

Note: Java JDK Standard Edition 1.6.0 (SR5)- 32 bit must be set in the path variable.

The Configure OFSAAInfrastructure Port Numbers screen will be displayed.

Configure OFSAAInfrastructure Port Numbers

Configure port numbers used by OFSAAInfrastructure.

Please choose your OFSAAInfrastructure install directory:

/fesscubes/revut1/Oracle71

Application Layer

Database Layer

Web Layer

OFSAAInfrastructure Java Port 8121

ICC Server Port 8124

ICC Native Port 8125

OFSAAInfrastructure Native Port 8122

OFSAAInfrastructure Agent Port 8123

OLAP Data Server Port 8126

Message Server Port 8127

Router Port 8128

AM Port 8129

Web Server Port 11185

Enter Database Details

Select your Database Oracle

IP Address 10.184.62.108

Port Number 1521

SID revkor

OFSAAInfrastructure username ofsaconf

OFSAAInfrastructure password

Refer the pre-installation activities check list section for more details about the Ports used in Infrastructure.

Click the Select button and select the path in which Infrastructure components have been installed. Alternatively you may enter the path in the space provided. Enable the corresponding check-boxes Application Layer, Database Layer or Web Layer based on the components that are installed on the current machine.

In the event you have performed a single-tier installation on the current machine, enable the check-boxes for all three components.

If you have installed more than one category of components on the current machine, enable the corresponding check-boxes for the respective components you have installed.

If you have installed only a single layer on the current machine, enable the corresponding check-box for the component you have installed.

To edit the port value, simply enter the new port value. User has the option to change

the required ports and leave the other ports unchanged. Only the ports for which values are modified will change and the ports that are unchanged will retain its default value.

Note: • All ports on a machine must be unique.

- The range of port numbers that are given should preferably be between 1025 and 65535.

Select the Database Type as Oracle from the options provided in the dropdown.

Enter the IP Address of the machine on which the corresponding database is installed.

Enter the Port Number on which the database is listening.

Enter the SID details.

Enter the Config Schema username password.

Click the Change button to initiate the port changes. Click Cancel to exit the program.

Once the port numbers are changed in the Infrastructure configuration, a message is displayed confirming the changes. The log Portchanger.log in the Infrastructure installation path provides the status of port changes performed.

For the above port changes to take effect, a re-start of all Infrastructure servers is required.

Note: These port changes are done only on the Infrastructure web components and not in the WebSphere installation directory (Infrastructure Application deployed directory) where EAR files are deployed. Thus, after the port changes on the Infrastructure web components are done, you will need to re-create the EAR files and re-deploy the EAR files. (Refer to Configuring the Servlet Engine chapter for more details.)

Web Server Port Change

The Web Server Port is the same as the Servlet Port. In the event you wish to change the servlet port after the installation process, you must follow the same process as above in the Port Changes section. This will change the servlet port in the Infrastructure application.

Stop and start Infrastructure Server following the steps given in Starting Infrastructure, page 11-1

Re-start WebSphere / Tomcat / WebLogic server.

Check the connectivity from Servlet URL

<http://<IPaddress>:<PortNumber>/<context-name>/servlet/com.iflex.fic.ficml.FICMaster>. The status should be successful for all the services.

Metadata Migration

The metadata created in the previous versions of OFSAAI cannot be used directly in current version of OFSAAI. It is required to a migration of metadata if you wish to use the older metadata.

Ensure that the following files are present in the \$FIC_HOME/MigrationUtilities /MetadataMigration_544/lib directory.

ummentities.jar

ojdbc6.jar

migration.jar

Navigate to \$FIC_HOME/MigrationUtilities/MetadataMigration_544/conf directory and edit Migration.conf file with the following parameters:

A) MIGRATE_UMM

This property specifies if the metadata needs to be migrated. Set this parameter value to 'YES'.

Example

MIGRATE_UMM=YES

B) [FICMASTER_DB]

Details to Connect to FICMASTER Schema

i) DBType

Type of database

Example

ORACLE

ii) DriverManager

The Driver Class name for connecting to type of database

Example

oracle.jdbc.driver.OracleDriver

iii) URL

The URL to connect to Database.

Example

jdbc:oracle:thin:@< Infrastructure Database server IP> :< oracle port>:<oracle SID>

iv) UserName

User Name to connect to Database

v) Password

Password of the user used to connect to database

C) [INFODOM_DB]

Details to Connect to Atomic Schema

i) DBType

Type of database

Example

ORACLE

ii) DriverManager

The Driver Class name for connecting to type of Database

Example

oracle.jdbc.driver.OracleDriver

iii) URL

The URL to connect to Database.

Example

jdbc:oracle:thin:@<Infrastructure Database server IP> :< oracle port>:<oracle SID>

iv) UserName

User Name to connect to Database

v) Password

Password of the user used to connect to database

Navigate to \$FIC_HOME/MigrationUtilities/MetadataMigration_544/bin. Edit Migration.sh file and specify the following properties as startup parameter:

\$INFODOM - Give the Information Domain name for which migration has to be done.

\$FTPSHARE_DIRECTORY

\$JAVA_HOME

\$MIGRATION_HOME

Run Migration.sh.

After the migration process is complete, grant full permissions to the ftpshare directory and its sub folders and files. This is done so that the new log files generated inherits the permissions granted to the ftpshare directory.

To do this, navigate to the ftpshare directory and execute the following command:
umask 0000

Infrastructure Configuration for LDAP

This provides you with the option of using LDAP (Lightweight Directory Access Protocol) authentication or Infrastructure SMS authentication for logging on to

Infrastructure.

If you are using the Infrastructure authentication, the user and user group details, profile creation, function and role maintenance and other mappings can be done through the Infrastructure Administration module under Security Management. The data, in this case, will be updated in the CSSMS table.

However, if you wish to use LDAP for user authentication, then you have to ensure that the LDAP server is installed and configured. The Infrastructure Installation wizard provides the option to select LDAP authentication for logging on to Infrastructure. If you select the LDAP Users option in the User Configuration screen during Infrastructure installation, application will be configured for using LDAP authentication.

If you have selected the LDAP option during Infrastructure installation, you will have to manually do the following configuration.

Note: Before doing the following configuration, it is required to select the Authentication type as LDAP in the Configuration screen of Infrastructure. This screen can be accessed by selecting System Configuration > Configuration in the left hand screen menu of Infrastructure.

Configuring Infrastructure Config Schema

In the Infrastructure Config schema make sure that the following entries are present in Configuration Table:

PARAMNAME	DESCRIPTION	PARAMVALUE EXAMPLES
AUTHENTICATION TYPE	AUTHENTICATION TYPE	2 (AUTHENTICATIONTYPE value must be 2 for LDAP)
ROOTCONTEXT	The Root Context for the LDAP Directory	dc=<Reveleus>,dc=<com>
ROOTDN	The Root dn for LDAP directory	cn=<Manager>,dc=<Reveleus> ,dc=<com>
ROOTPASS	Password for the Root	<secret>
LDAPURL	LDAP URL.	<ldap://10.80.193.35:389/>

Note: ROOTCONTEXT, ROOTDN, and ROOTPASS entries should be same as slapd.conf file.

Configuration of Openldap Files

1. Copy the reveleusSchema.schema from <Infrastructure Installation Directory>/ficapp/common/ficserver/conf/LDAP_ldif folder to LDAPServer Schema folder.
2. Copy the Domains.ldif and Reveleus.ldif files from <Infrastructure Installation Directory>/ficapp/common/ficserver/conf/LDAP_ldif folder to OpenLDAPServer folder.

Note: • Make sure that the ROOTCONTEXT in the Domains.ldif and Reveleus.ldif files are the same as slapd.conf file.

3. Make the appropriate entries for rootdn, rootpass and rootcontext in slapd.conf file in the OpenLDAPServer folder.
4. Add the following text as the first line of the slapd.conf file include schema/reveleusSchema.schema

Note: • The above configuration is for OpenLDAP Server only. If you need to configure Infrastructure for ApacheDS Server or any other LDAP Server, you will have to make the changes appropriately. Contact Infrastructure Support for more clarifications.

5. In the command prompt, navigate to the LDAP installation directory and execute the following command:

```
ldapadd -D"ROOTDN" -w ROOTPASS -f/data/Reveleus.ldif
```

This is for creating the entries for Users, User Groups, Functions, Profiles, Segments, Domains, Roles, and HolidayMaster in the Data information Tree of LDAP.

6. For each information domain that is created through the Infrastructure UI, it is required to make an entry in the Domains.ldif file. To add an entry corresponding to the new information domain to the Domains.ldif file, add the following block of text with the appropriate values:
 - dn: DSNID=<DSN ID>,ou=Domains,@LDAP_DIRECTORY_ROOTCONTEXT@

- changetype: add
- mappedsegments: <Mapped segments/~>
- dsnid: <DSN ID>
- infodomname: <Information Domain Name>
- objectClass: Infodom
- objectClass: top
- infodomdescription: <Information Domain Description>

Example

- dn: DSNID=FUSIONMOCK, ou=Domains, dc=FTP1,dc=com
- mappedsegments: ~
- dsnid: FUSIONMOCK
- infodomname: FUSIONMOCK
- objectClass: Infodom
- objectClass: top
- infodomdescription: FUSIONMOCK

Then, navigate to the LDAP installation directory and execute the following command:

```
ldapmodify -D"ROOTDN" -w ROOTPASS -f/data/Domains.ldif
```

Note: You can add entries for multiple information domains at the same time.

Migration of Data from CSSMS tables to LDAP server

If you are using LDAP authentication, it is required to migrate all the details from the CSSMS table, which contains the information entered using the Infrastructure Administration module under Security Management to the LDAP Server.

1. In the command prompt, navigate to \$FIC_HOME/MigrationUtilities/Migration_LDAP/bin and invoke the LDAP_Migration.sh file.
2. The Select Source & Destination for Migration window is displayed.

This screen provides you the option to migrate the data from CSSMS to LDAP or vice versa. Select the SMS to LDAP option to migrate all the user information from the CSSMS table to the LDAP server.

3. The Select Entities to Migrate window will be displayed. You can select the data that you wish to migrate such as Users, User Groups, Functions, Roles, Segment, Profiles, Holiday Master, Function Role Maps, User – User Group Maps, User Group Role Map, and User Group- Domain Map.

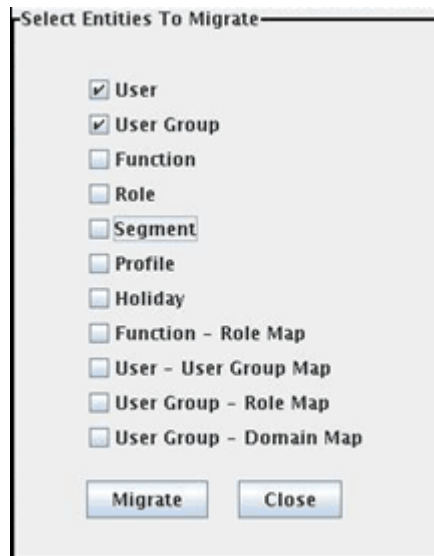

Select the entities that you wish to migrate and click Migrate. The migration will take place and a confirmation window will be displayed. You can verify the data migrated to LDAP server through the LDAP Browser.

4. You should also enter the passwords for all the users as passwords are not migrated in migration process.

Kindly contact Infrastructure support for more information on Infrastructure Configuration for LDAP.

IE Settings

The following browser settings have to be specified at every client machine prior to

accessing the Infrastructure application.

Open Internet Explorer. Select Tools > Internet Options. The Internet Options window is displayed. Click the Settings button. The Settings window is displayed. Select the Every Visit to the page option. Click OK.

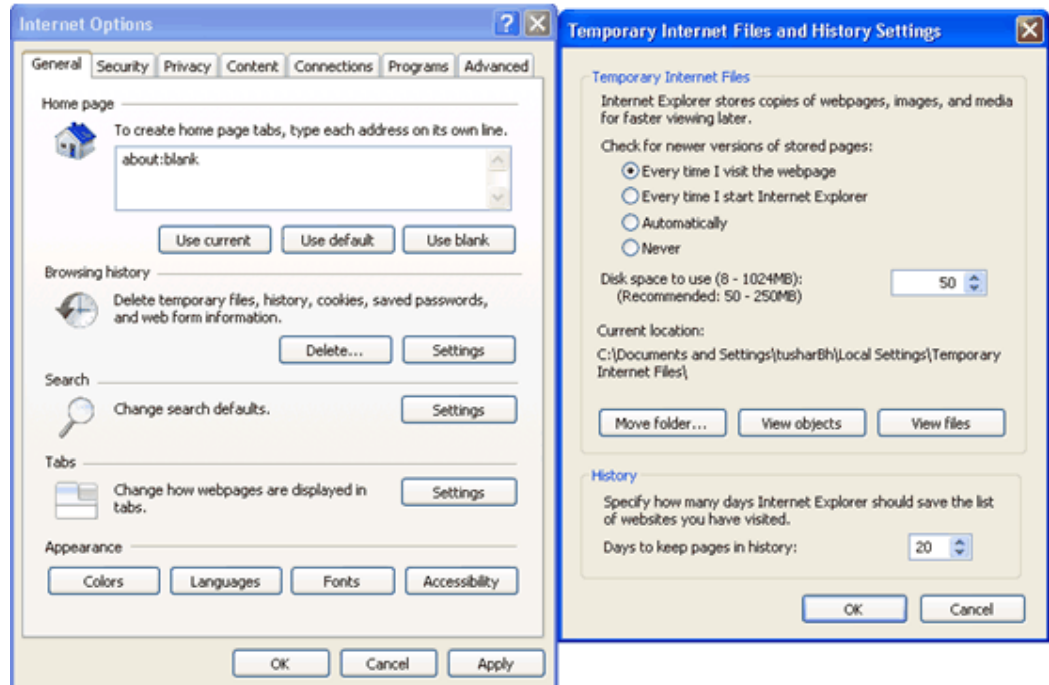

In the Internet Options window, select the Security tab and select the Internet option under Select the Web content zone to specify its security settings.

Click Default Level under Security level for this zone.

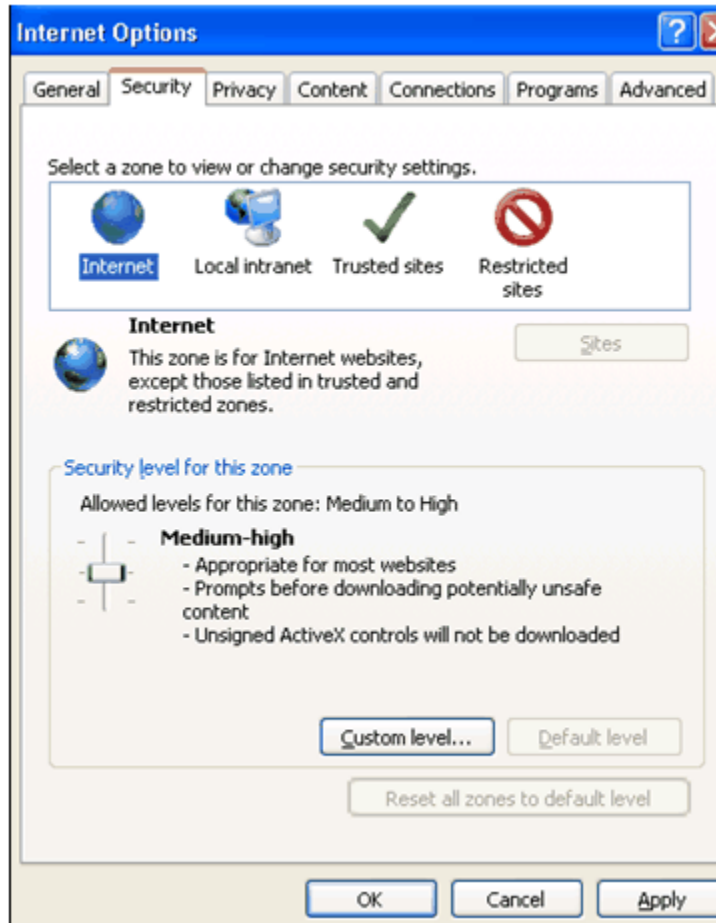

If the browser is accessed through Windows XP, this Infrastructure installation site needs to be added to the list of trusted sites. This can be done from the Internet Options window.

Select the Security tab and select the Trusted Sites option. Click the Sites... button. In the Trusted Sites window that is displayed, enter the Infrastructure URL in the Add this Web site to the zone box. Click OK.

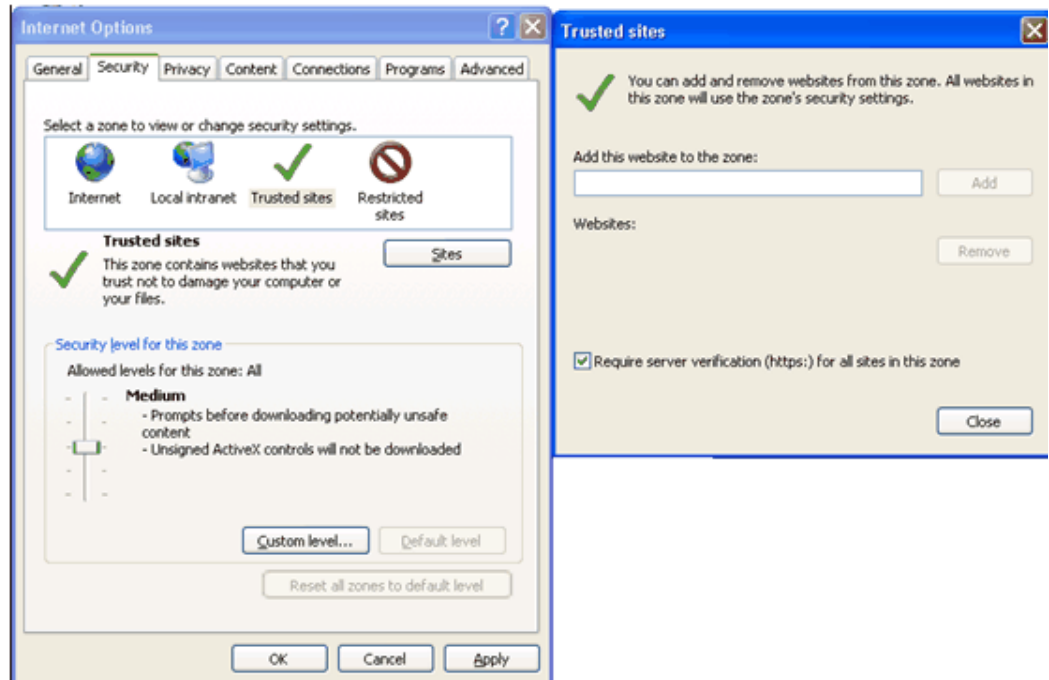

Click OK in the Internet Options window to save the settings.

SFTP and FTP Configuration

The user can choose the type of FTP configuration required. The user can choose to have either Secure FTP or FTP. Based on the choices made, the users used for installation of each of the Infrastructure components should be configured appropriately.

The SFTP/FTP services should be enabled and the respective ports should be open for connection.

In case of multi-tier installation of Infrastructure, when choosing FTP or SFTP configuration, make sure that the same configuration is done for Database, Application and Web Servers.

Note: For SFTP configuration, openssh-4.3 software should be downloaded and installed in all the Infrastructure Server machines. You can download it from <http://www.openssh.com/openbsd.html>

FTP/SFTP services are required when configuring all Server Details for the Database Server and Application Server as documented in Configuring Database Server Details, page 13-1.

The command below can be used on either the Database Server, Application Server or Web Server to verify the availability and connectivity of ftp/sftp services:

ftp/sftp <<IP address or HOSTNAME>>

Starting Infrastructure

Introduction

Once the installation of Infrastructure has been completed successfully and the post-installation steps are completed, the servers must be started. Log on to each machine and run the .profile file. All servers mentioned must be started from the same shell encoding. The servers mentioned below are dependent on each other. It is mandatory to maintain the order in which the servers are started. Allow each of the servers to initialize completely before starting the next server.

Starting the Infrastructure Server

On the machine in which Infrastructure Application components have been installed, navigate to `$FIC_APP_HOME/common/FICServer/bin` and execute the following command to start the Infrastructure Server:

```
./reveleusstartup.sh
```

- When starting the server the first time, it must be done in the foreground to answer prompts. Enter the password of the Oracle Config schema, when it prompts for a system password. This password is asked only the first time of starting Infrastructure server.
- If the Oracle Config schema password is changed, delete the Reveleus.SEC file under `$FIC_HOME/conf` and start the server.
- When saving Database Server Details during Infrastructure Configuration, the Infrastructure server must also be started in the foreground to answer the following prompt on save:

The host 10.123.45.678 is currently unknown to the system

The host key fingerprint is: 1023: 1e 35 46 7f 81 e7 16 6b 33 e8 59 f7 d cf 5b b1

Do you want to allow this host key? [Yes|No|Always]:

Always should be entered when prompted.

- After the initial startup of the Infrastructure server and completion of Infrastructure configuration, the server may be started as a background process using the following:

```
nohup ./reveusstartup.sh
```

- Any router connection errors in the revappserver.log may be ignored.

Starting Websphere profile

On the machine where Websphere is installed, navigate to [Webshpere_Install_Directory] / AppServer/<profiles>/<profile name>/bin and execute the following command to start the Websphere server:

```
startServer.sh server1
```

Starting the Tomcat Application

On the machine in which Tomcat is installed, go to the <Tomcat_Install_Directory>/bin and execute the following command to start the Tomcat server:

```
./catalina.sh run
```

Starting WebLogic profile

On the machine in which Weblogic is installed, navigate to <WebLogic Installation directory>/user_projects/domains/<domain name>/bin and execute the following command to start the Weblogic server

```
startWebLogic.sh -d64
```

Note: If WebLogic is already running, access the WebLogic Admin Console. Stop & start the application <context name>.ear

Starting the Information Command Center (ICC) Server

On the machine in which Infrastructure default Application components have been installed, navigate to \$FIC_HOME/ficapp/icc/bin and execute the following command to start the ICC server:

```
./iccservlet.sh
```

Note: Only the Infrastructure Default Application Server would hold the ICC components.

Starting the Agent Server

On the machine on which Infrastructure Database components have been installed, navigate to \$FIC_DB_HOME/bin and execute the command to start agent server:

```
./agentstartup.sh
```

Note: This agent will internally start the Router, Message Server, OLAP data server and AM servers.

Starting the Infrastructure Server Administrative Console

Under default Application Instance, navigate to \$FIC_HOME/ficapp/common/FICServer/bin and execute the following command to start the Infrastructure Server Administrative Console:

```
./AdminConsole.sh
```

Note: The Administrative Console must be started either directly on the server or via X-Windows software as a GUI window will appear once started.

Starting the LDAP Server

On the machine in which LDAP Server is installed, go to the OpenLDAP installation directory through the command prompt and execute the following command to start the LDAP server:

```
slapd -d 1
```

Note: Enter any user-defined password when prompted.

Logging into Oracle Financial Services Analytical Applications

All applications services have now been started. The application can be accessed from a client machine. From a client workstation, open the client browser and provide the URL as `http://<IP address>:<servlet port>/<context-name>/login.jsp`.

Example

<http://10.80.122.228:8888/reveleus/login.jsp>

Note: If https configuration is enabled, the client browser will need to disable the proxy servers through the client browser's internet options.

This displays the login screen of Infrastructure.

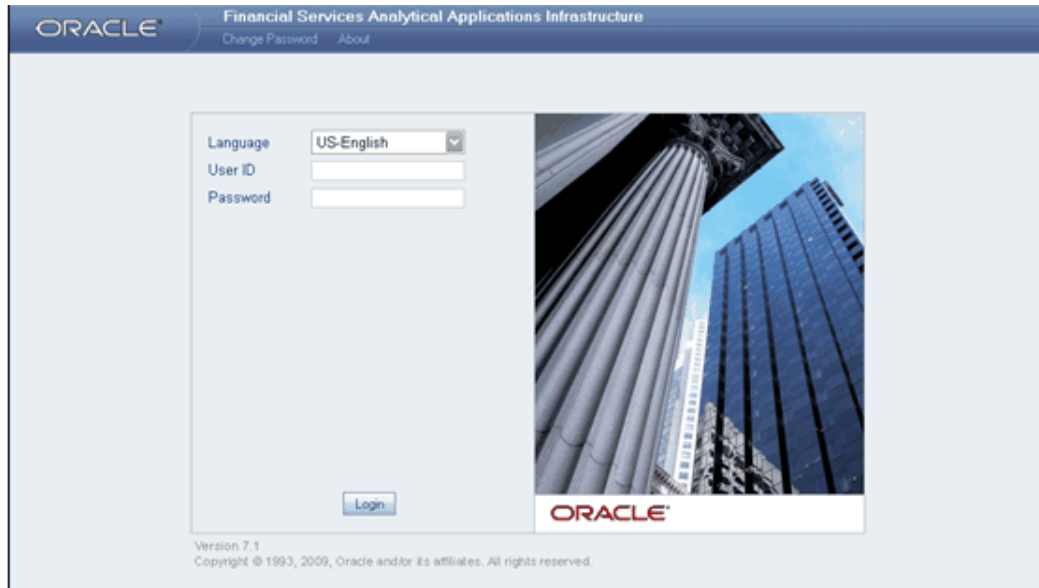

There are two in-built system administration users provided by the system:

- SYSADMN: <no password>
- SYSAUTH: <no password>

Log on to the application using "SYSADMN" as the User Id. The first time you log in, you will be prompted to change the password. **Note:** There is no "I" in the "SYSADMN" login.

Note: Several configuration activities are to be carried out before starting working on Infrastructure. Refer to the following configuration chapters in this guide for more details.

System Configuration

Introduction

The **System Configuration** function enables you to define Server, Database, Information Domain and Configuration.

System Configuration activities should be performed by the system administrator using a System Administrator User Id.

Click + to access the list of System Configuration options.

System Configuration activities can be categorized into three logical groups.

Group I assists the administrator while configuring various server components and miscellaneous activities. This needs to be done in the following order:

- Server Details
- Database Details
- Configuration

Group II assists the system administrator while configuring activities relating to setting up of the warehouse for various information analytics.

- Information Domain

Configuring Server Details

This feature helps the administrator to configure the various server setup details in Infrastructure .

Prerequisites

- Successful completion of Infrastructure Installation.

- Infrastructure System Administration User Id / Password.
- Availability of FTP/SFTP services, User Id with appropriate rights and Password information in the Application Server, Database Server(s) and Web Server(s).

FTP/SFTP services are required when configuring all Server Details for the Database Server and Application Server as documented in 'Configuring Database Server Details'.

See System Configuration, page 12-1, Configuring Database Server Details, page 13-1 and Configuring Details, page 14-1 (contains Information Domain creation information)

The command below can be used on either the Database Server, Application Server or Web Server to verify the availability and connectivity of ftp/sftp services:

```
ftp/sftp <<IP address or HOSTNAME>>
```

Configuring Database Server Details

To configure database server

Click Server Details to expand its sub-options, namely Database Server, Application Server and Web Server.

The database layer of Infrastructure can be represented by a single database server. This option helps the user to capture the database server(s) set-up details.

Click the **Database Server** option to open the **Server Master** screen.

Note: Several information domains can reside on the same database server; however one information domain can be mapped to only one database layer.

The screenshot displays the Oracle Financial Services Analytical Applications Infrastructure (FAAI) Server Master configuration window. The interface is titled "Server Master" and shows the "DataBase Server Details" section. The IP Address is set to 172.20.81.114, and the Socket Server Port is 10101. The OS type is Linux, and the FTP and SFTP options are checked. Below this, the "FTP Details" section is visible, with the "Technical Metadata" tab selected. The fields in this tab include Drive (F:\oracle\user\qshard), Port Number (22), User Id (puser), and Password. At the bottom of the window, there are buttons for "Add", "Modify", "Next", "Cancel", and "Help".

Using the **Server Master** wizard, you can specify details of the machines on which Infrastructure Database, Application and Web components have been installed. You can use the **Add** and **Edit** modes in the Server Master screen.

Configuring Database Server Details

The Add option in the DataBase Server Details screen enables the user to provide set-up details for a database server and add multiple servers. The IP addresses of all the three Infrastructure servers entered during setup cannot be modified. The first screen accepts the Database server information like Database FTP/SFTP drive details, user Id and password.

The user should create the FTP/SFTP information manually, prior to entering the details.

The application will check if the details provided are correct. Apart from the FTP information, the screen also considers the socket server port in the database machine by default. Be sure to have the Infrastructure server started in the foreground to answer the following prompt which will appear in the Unix server command window when saving Database Server Details:

The host 10.123.45.678 is currently unknown to the system

The host key fingerprint is: 1023: 1e 35 46 7f 81 e7 16 6b 33 e8 59 f7 d cf 5b b1

Do you want to allow this host key? [Yes|No|Always]:

Always should be entered when prompted.

The FTP/SFTP information is accepted based on the following details in the Database Server:

Technical Metadata: Information related to the Entities and Attributes are stored in this path.

Business Metadata: Business Logic XML's are stored in this path.

Staging Area: The raw data files are moved or transferred into this folder. The system also transfers the extracted data file into this folder.

Note: In UNIX, you will not require an FTP/SFTP share name. The drive name is captured as share name.

Validations

- FTP/SFTP information cannot be blank.
- The Host DB type cannot be blank.

Modifications

The system allows modifications of the PATH and other related FTP/SFTP information. However the old files should be physically moved to the new path. The system ensures that all new files are generated / transferred into the new path.

In the second screen the user is required to enter the security details for the server settings. For each of the entries there will be single line help on the same screen. The **Information Command Center (ICC)** will use this information for judiciously using the system resources.

In the third and fourth screens the user is required to enter Web server and Application server details.

- This feature cannot be used as a migration tool. It is usable only in cases where the user has changed the IP address of the physical machine in use as the Database Server.
- Changing the IP address of the physical machine in use will have no impact on the activities being performed on that machine.
- However, if the user chooses to move the DB server from one machine to another machine, the IP address of the machine will definitely be different. In this case it is mandatory to setup/install the DB server on the new machine. The following example illustrates the point.

Web IP Address	App IP Address	DB IP Address
14.16.1.1	14.16.1.2	14.16.1.3
14.16.1.1	14.16.1.2	14.16.1.4

Scenario 1

- The IP Address of the machine on which the DB server is installed is 14.16.1.3. For some reason you change this IP Address to 14.16.1. 4. The system will handle this scenario, by modifying the address in relevant places. Since there is no need for a migration in this case, the system will work with the changed IP address. This is possible because the activities being performed on the machine will continue on the same physical machine with the only change being that of the IP address.

Scenario 2

- There is a change in the Physical DB Machine from 14.16.1.3 to 14.16.1.4. In this case, the User should run the DB Server setup utility and the Migration utility to change the Db server information.

- Unlike scenario 1 where only the IP address of the physical DB machine had undergone a change, scenario 2 explains a situation where the DB server is moved to another physical machine, hence the system processes will not be able to function till the DB server is setup and configured on the new physical machine.

Defining Server Details

Click Server Details to expand the options within it, namely Database Server, Application Server and Web Server. Select Database Server to view the Database Server Details screen.

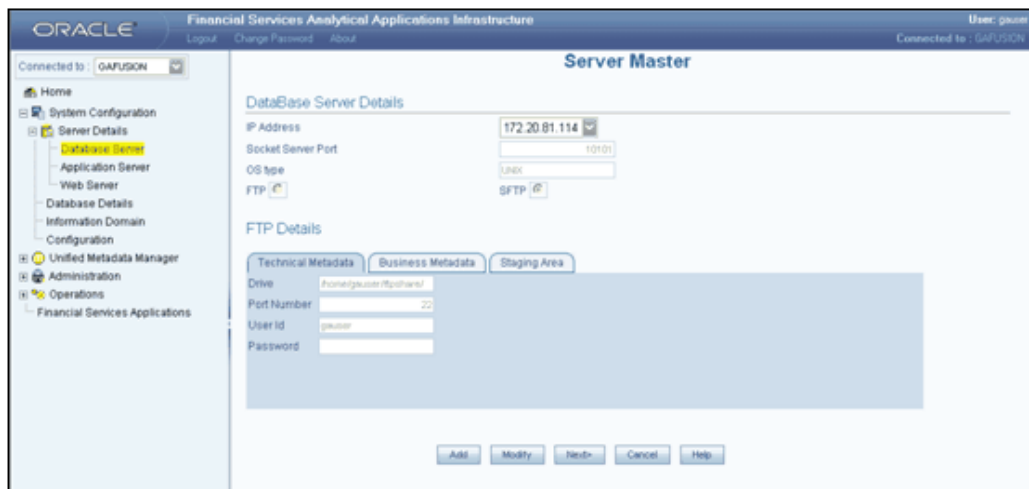

- FTP/SFTP service should be installed on the Web/Application and DB Server.
- The FTP/SFTP ID for Web/App and DB server needs to be created through the Computer Management option under Administrative Tools for all the installations other than UNIX installations. This user should belong to the administrator group.
- The FTP/SFTP password for Web/App and DB server needs to be specified in the Computer Management option under Administrative Tools. Select the Password Never Expires option.

Entering Database Server Details

Click **Database Server** option to open the Database Server Details screen.

In the first screen of the wizard, you are required to specify the database details. To define database details, click **Add**, which will cause the screen to refresh and display blank fields.

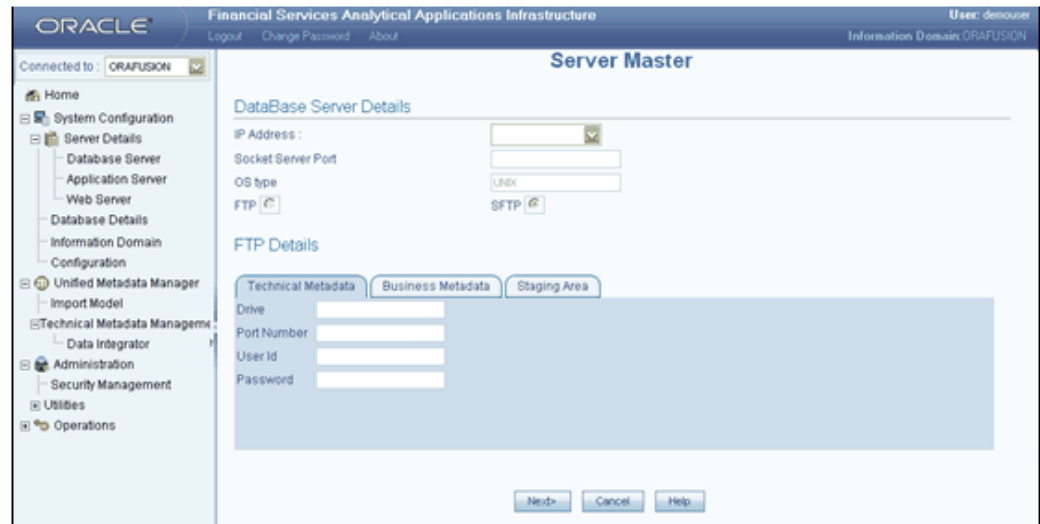

The screenshot shows the Oracle Financial Services Analytical Applications Infrastructure (FSAAI) Server Master interface. The main window is titled "Server Master" and displays the "DataBase Server Details" configuration screen. The interface includes a navigation tree on the left with options like Home, System Configuration, Server Details, Database Server, Application Server, Web Server, Database Details, Information Domain, Configuration, Unified Metadata Manager, Import Model, Technical Metadata Management, Data Integrator, Administration, Security Management, Utilities, and Operations. The main content area has the following fields:

- IP Address:** A dropdown menu.
- Socket Server Port:** A text input field.
- OS type:** A dropdown menu with "UNIX" selected.
- FTP:** Two checkboxes, "FTP" and "SFTP", both of which are checked.
- FTP Details:** A section with three tabs: "Technical Metadata", "Business Metadata", and "Staging Area". Under "Technical Metadata", there are input fields for "Drive", "Port Number", "User Id", and "Password".

At the bottom of the screen, there are three buttons: "Next>", "Cancel", and "Help".

Specifying the IP Address

The IP Address refers to the IP configuration of the machine where the database server is installed. This should be the same IP Address that the systems administrator had specified during the Infrastructure (Database Layer) Installation.

Specifying the Socket Server Port

As the Socket Server Port is already fetched by default, this field should be left with the default port number.

Specifying the OS Type

The **OS type** (Operating System) of the database is detected by the Infrastructure Application and cannot be edited.

Example

NT

- The current system supports only similar OS types in a single implementation, i.e. all database servers should be installed in

machines with same OS types. In case of UNIX implementations, all the database servers can be of type UNIX (same version).

- Infrastructure does not support UNIX and NT combination.

Entering FTP/SFTP Details for the Database Server

FTP refers to the transfer of files from one server to another. Database servers, Application server and Web servers of Infrastructure need to transfer files such as metadata and staging files between each other.

SFTP refers to secure FTP for transfer of files from one server to another database server. For each database server, the FTP or SFTP path for receiving and sending files, user id / password details need to be defined for Technical Metadata, Business Metadata and Staging Area related files transfer.

Select the FTP or SFTP option button based on your requirements.

Infrastructure allows users to maintain the paths on the servers where metadata is expected to reside based on their machine configuration. The paths include Scripts or Business Metadata, Log, Erwin or Technical Metadata and Stage. Infrastructure creates files into these paths that include the following:

- Erwin Path, currently referred to as path for Technical Metadata, stores
- TFM and Database Model XML files
- Table Creation scripts
- SCRIPTS Path, currently referred to as path for Business Metadata, stores
- Log Path, stores the Log files for all the Backend and Front-end components.
- Stage that stores the FLAT file to be loaded through Data Integrator. This is the only path that is not tagged to any Information Domain.

Users can individually maintain the above-mentioned paths in different drives based on the machine configuration.

Example

Erwin Path (Technical Metadata) can be in (Windows) - c:\Infrastructure \Erwin (or) (UNIX) - /usr/Infrastructure /Erwin

Scripts Path (Business Metadata) can be in (Windows) - f:\Infrastructure \scripts (or) (UNIX) - /usr/Infrastructure /scripts

Log Path can be in (Windows) - d:\Infrastructure \Logs (or) UNIX - /usr/Infrastructure /logs

Example

Erwin Path (Technical Metadata) can be in (Windows) - c:\Infrastructure \Erwin (or) (UNIX) - /usr/Infrastructure /Erwin

Scripts Path (Business Metadata) can be in (Windows) - c:\Infrastructure \scripts (or) (UNIX) - /usr/Infrastructure /scripts

Stage Path can be in (Windows) – c:\Infrastructure \Stage\ or (UNIX) - /usr/Infrastructure /Stage/

Defining Technical Metadata

The Technical Metadata tab is selected by default.



The screenshot shows a configuration window with three tabs: 'Technical Metadata', 'Business Metadata', and 'Staging Area'. The 'Technical Metadata' tab is active. Below the tabs are four input fields: 'Drive' with the value '/home/gauser/ftpshare/', 'Port Number' with '22', 'User Id' with 'gauser', and 'Password' which is empty.

Infrastructure creates the following set of files under this category.

The ERWin path, currently referred to as the path for Technical Metadata, stores the following:

- TFM and Database Model XML files
- Table Creation scripts

The Information entered in this screen is automatically copied to Business metadata and staging area as default values.

Specifying Drive Information

Specify the physical path of the FTP/SFTP shared directory/drive of the database in the Drive field.

Example

e:/dbftp/

Specifying the Share Name

Enter the Share Name of the folder. The share name has to be created as a virtual directory under the 'FTP/SFTP default sites', and should point to the directory specified

in the above step.

Example

Db ftp

Specifying the Port Number

The port number refers to the database FTP/SFTP port number. Enter the Port Number.

Note: The default SFTP port number is 22. This can be changed by the user as required provided the port is enabled for the same.

Specifying the User Id

The User Id refers to the user Id that will be used to perform an FTP/SFTP in the machine where the database server is located. It is mandatory that you enter an FTP/SFTP User Id.

Note: The FTP/SFTP ID for Web, Application and Database server needs to be created through the Computer Management option under Administrative tools for all installations other than UNIX installations. This user should belong to the administrator group.

Specifying the Password

The FTP/SFTP Password is the password for the FTP/SFTP user Id that the administrator has specified. Enter the FTP/SFTP Password. The password is represented by asterisk (*) to prevent others from knowing the password.

While specifying the password certain characters are restricted. The only characters which are allowed are listed below.

"@", "-", "_", "\", "/", ":", "."

- The FTP/SFTP password for Web, Application and Database server must be specified in the Computer Management option under Administrative Tools. Select the Password Never Expires option.
- The accessibility to the Database, Application and Web servers using the Id / password will be confirmed before saving.

Defining Business Metadata

Select the Business Metadata tab.

Technical Metadata	Business Metadata	Staging Area
Drive	/home/gauser/ftpshare/	
Port Number		22
User Id	gauser	
Password		

Infrastructure creates the following set of files under this category Scripts Path, currently referred to as path for Business Metadata. It stores basically the business logic XMLs.

- Cube Configuration files
- Hierarchy Parentage files

By default, it displays the details entered in the Technical Metadata screen and can be edited. The data input is similar to the Technical Metadata screen for data entry.

Specifying Staging Information

Select the Staging Area tab.

Technical Metadata	Business Metadata	Staging Area
Drive	/home/gauser/ftpshare/	
Port Number		22
User Id	gauser	
Password		

The Infrastructure Stage area stores the FLAT files (data files) to be loaded through Data Integrator. This is the only path that is not tagged to any Information Domain. These flat files could be created or transferred by the user by some Infrastructure process.

By default, it displays the details entered in the Technical metadata screen and can be edited. The data input is similar to the Technical Metadata tab.

Click **Next>** to go to the next screen. If you wish to clear the fields, click Cancel. Click Help to open help for the **Server Master** screen.

Adding Security Details

In the Security Details screen you are required to enter Security Details for the Database Server.

In this screen, the administrator can define the Security User Id, the Security Password and the Security Share Name.

Specifying the Security User Id

The Security User Id that is specified in this screen should be assigned the same rights as the user who installed Infrastructure.

The Application server needs to pass the database user Id / Password to the database server(s) for connection purposes. These details can be transferred using the same FTP share area / user id and password used for transferring the Technical / Business/Stage area related files.

Alternatively for secure FTP, a different User Id and Password can also be used.

Example

secuser

Note: Ensure that the user using this user Id has been provided rights to perform an FTP/SFTP in the database server.

Specifying the Security Password

The Security Password is the password of the user who will be accessing the security share name. The password is represented by asterisk (*) to prevent others from knowing the password.

Specifying the Security Share Name

During the Infrastructure Installation the user would have identified the path where DB components would be stored. The Security Share Name that the System Administrator provides in the Security Details screen should point to the DB components installation folder.

Example

D:/Infrastructure

For the UNIX setup

The security Id should be the Id of the user who has the same user right as the User who installed Infrastructure. This user should have write permissions on the DB Components Installation folder like /usr/users/user1/Infrastructure

The security password is the user password of the user who will be accessing the security share name.

The security share name that you provide in the security details screen should point to the DB components installation folder. Enter the Security Share Name in the field provided for security share name.

Example

/usr/users/user1/Infrastructure

Click <Back> to go to the previous screen. Click Save to save the server details. Click Cancel to reset the definition and return to the first screen. Click Help to open help for the Security Details screen.

Be sure to have the Infrastructure server started in the foreground to answer the following prompt which will appear in the Unix server command window when saving Database Server Details:

The host 10.123.45.678 is currently unknown to the system

The host key fingerprint is: 1023: 1e 35 46 7f 81 e7 16 6b 33 e8 59 f7 d cf 5b b1

Do you want to allow this host key? [Yes|No|Always]:

Always should be entered when prompted.

Configuring Details

Configuring Application Server Details

The Application layer of the Infrastructure system is maintained by the Application server. The Application layer houses shared services, sub system services, ICC server etc to manage the warehouse operations.

This feature helps the user to capture the Application Server set-up details. Click the Application Server option in the function menu list to open the Application Server Details screen.

The screenshot displays the Oracle Financial Services Analytical Applications Infrastructure (FAAI) Server Master interface. The window title is "ORACLE Financial Services Analytical Applications Infrastructure" and the user is "gaur". The interface shows a navigation tree on the left with "Application Server" selected. The main area is titled "Server Master" and contains "Application Server Details" and "FTP Details" sections. The "Application Server Details" section has fields for "IP Address" (172.20.81.114) and "FTP" (SFTP). The "FTP Details" section has tabs for "Technical Metadata", "Business Metadata", and "Staging Area". The "Technical Metadata" tab is active, showing fields for "Drive" (Home/gaur/ftpshare/), "Port Number" (22), "User Id" (gaur), and "Password". At the bottom are "Modify", "Cancel", and "Help" buttons.

In this screen you are required to enter **Application Server Details** and **FTP/SFTP Details**.

- Once the Infrastructure installation is complete and while entering the Application Server set-up details for the first time, the Server

Master screen opens in the Add mode.

- On having added application server information, the next time the administrator accesses the application server screen it will be displayed in the View mode.

The Server Master screen accepts the Application server information. Application server details can be viewed or modified after the first time definition.

The three tabs available for FTP/SFTP Share details are the **Technical Metadata**, **Business Metadata** and **Staging Area**.

By default the IP Address of the Application Server is displayed in the IP Address field in the Application Server Details section.

The **Add** option enables the user to provide set-up details for an application server.

Enter the details accordingly.

Click **Save** to save the Application server details. Click **Cancel** to reset the definition.

Click **Help** to open help for the Application Server Details screen.

Modifying Application Server Details

The system administrators can modify FTP/SFTP details.

Note: When there is a change to the FTP/SFTP path, the old files should be physically moved to the new path. The system ensures that all new files are generated /transferred into the new path.

How to handle Change in IP Address

There could be two scenarios where the IP Address of the Application server could change.

- Change in IP Address of the Application server machine in use.
- Application server is physically moved from one machine to another.

Please contact Infrastructure Support for further details.

Configuring Web Server Details

The Infrastructure presentation layer could be implemented in two ways:

- Installation of Single Web Server.
- Installation of Primary Web Server and one more secondary servers.

This option helps the user to capture the Primary and Secondary Web Server set-up details. Click the Web Server option under Server Details in the function menu to open the Web Server Details screen.

The screenshot displays the Oracle FSAAI Server Master interface. The top navigation bar includes 'ORACLE', 'Financial Services Analytical Applications Infrastructure', and 'User: demouser'. The left sidebar shows a tree view with 'Web Server' selected under 'Server Details'. The main content area is titled 'Web Server Details' and contains the following fields:

Field	Value
IP Address	172.20.81.116:7001
Servlet Port	7001
Is Primary	<input checked="" type="checkbox"/>
Local Path (*Please enter a valid path)	/export/home/Rev7webtp
Shared Storage Enabled	<input checked="" type="checkbox"/>
Reveleus Content	reveleus
Protocol	http
FTP Enabled	<input checked="" type="checkbox"/>
FTP Details	SFTP
Drive	/export/home/Rev7webtp
Port Number	22
User Id	Rev7web
Password	

Buttons at the bottom: Add, Modify, Cancel, Help.

In this screen, you are required to enter **Web Server Details** and **FTP/SFTP Details**. The Server Master screen accepts the web server information. Web server details can be viewed, added or modified.

Shared storage: In this option, files will be written and read from the web server as local. No transfer or copy of the files is done. This option is to be used when there is SAN available or folders of different web servers can be shared. SAN is storage area network designed to attach computer storage devices such as disk array controllers and tape libraries to servers.

Is Primary (Primary Web Server): In this option all the static files are transferred to the primary web server.

Infrastructure supports FTP/SFTP into Web Server and streaming of files. There may be cases where FTP/SFTP is not allowed into a Web Server due to security reasons. In those circumstances, Infrastructure can stream data across the Web Servers, so that the Client need not compromise on their Security policy. Infrastructure supports both HTTP and HTTPS protocols for this reason.

Adding Web Server Details

Infrastructure allows the creation of one or more Web Servers. However, one Web server needs to be defined as primary server.

An example, to why there is a need for two or more web servers, is to route users through different web servers. There could be a need of routing internal users through one web server and other users through another Web server.

Click **Add** to enter the web server details.

Specifying the IP Address

To enter Web Server details, click the **IP Address** drop-down list and select the IP address. The IP addresses that are displayed are those that were created during the Infrastructure installation.

Example

10.80.50.226

Specifying the Servlet Port Number

The port number is the web server port number. Enter the **Servlet Port number**.

Example

21

Selecting the Primary Web Server

If the administrator selects the Is Primary check box; all static files will be placed in the primary web server.

Specifying the Local Path

In the Local Path field, the administrator needs to mention the location for the static files in the primary server. The web server contains files copied from Infrastructure Insight and Portal, which serve as static pages.

Example

e:/revftp/

The file reference between web servers is possible through three methods:

1. Shared storage.
2. Copying and transferring files across Web servers using the FTP/SFTP option.
3. Streaming of data across Web servers using HTTP or HTTPS protocols.

Enabling Shared Storage

Shared storage files will be written and read from the web server as local. It is not possible to transfer or copy these files. This option can be used when a shared area network is available or folders of different web servers can be shared. Select the Shared Storage Enabled checkbox to enable this option.

Enabling FTP

Click to select the FTP Enabled field. Infrastructure supports FTP/SFTP into web server

and streaming of files.

- There is an option to configure more than one web server details with the Add option. Click Add to add the new web server details.
- The user can configure the web server installed in the other machine as the current web server for the existing set up by selecting the Is Primary option, while defining the web server details.

FTP/SFTP Details of the Web Server

Based on whether FTP/SFTP is allowed on a Web Server, Infrastructure will accept the Servlet Port. The Drive, Share Name, Port Number, User Id and Password fields become available when you select the FTP Enabled check box.

For each database server, the FTP or SFTP path for receiving and sending files, user id / password details need to be defined for **Technical Metadata**, **Business Metadata** and **Staging Area** related files transfer.

Select the **FTP** or **SFTP** option button based on your requirements.

The screenshot displays the Oracle Financial Services Analytical Applications Infrastructure Server Master configuration interface. The left sidebar shows a navigation tree with 'Web Server' selected under 'Server Details'. The main content area is titled 'Web Server Details' and contains the following fields:

- IP Address: 172.20.81.114:13212
- Servlet Port: 13212
- Is Primary:
- Local Path ("Please enter a valid path"): F:\oracle\user\ftps\share/
- Shared Storage Enabled:
- Reveals Content:
- Protocol: http
- FTP Enabled:

Below the 'FTP Enabled' section, there are two tabs: 'FTP' (selected) and 'SFTP'. The 'FTP' tab contains the following fields:

- Drive: F:\ftps\share/
- Port Number: 22
- User Id: guest
- Password: (empty)

At the bottom of the form, there are buttons for 'Add', 'Modify', 'Cancel', and 'Help'.

Specifying the FTP Drive

When FTP/SFTP is allowed for web servers to communicate with each other, the FTP/SFTP drive needs to be identified. Enter the FTP/SFTP drive in the Drive field.

Example

D:/ftps\share/

Specifying the Share Name

Enter the Share Name of the folder. The share name has to be created as a virtual directory under the 'FTP/SFTP default sites', and should point to the directory specified in the above step.

Example

ftpshare

Specifying the Port Number

The port number refers to the database FTP/SFTP port number. Enter the Port Number.

Example

22

Specifying the FTP User Id

The FTP/SFTP User Id refers to the user Id that will be used to perform an FTP/SFTP in the machine where the web server is located.

Example

revtest

Note: The FTP/SFTP ID for Web/App and DB server needs to be created through the Computer Management option under Administrative tools. This user should belong to the administrator group.

The Password is the password for the FTP/SFTP User Id the administrator has specified. The password is represented by asterisk (*) to prevent others from knowing the password.

Example

- The FTP/SFTP password for Web, Application and Database servers needs to be specified in the Computer Management option under Administrative Tools. Select the Password Never Expires option.
- The accessibility to the Database, Application and WEB server using the Id / password will be confirmed before saving.

Adding Servlet Port /FTP/SFTP Details – FTP Not Enabled

There may be cases where FTP/SFTP is not allowed into a web server due to security reasons. In those circumstances, Infrastructure can stream data across web servers, so

that the client does not compromise on his/her security policy. To achieve this, Infrastructure supports both HTTP and HTTPS protocols.

If FTP/SFTP is not allowed into the web server, do not select the FTP Enabled checkbox. In this case, the fields that will be displayed are **Protocol** and **Infrastructure Context**.

Specifying the Protocol

Choose the protocol **HTTP** or **HTTPS** from the list down box.

Specifying the Infrastructure Context

Enter the context in the **Infrastructure Context** field.

Click **Add** to define a new Web server details. Click **Modify** to edit the existing Web server details. Click **Cancel** to reset the definition in case you are defining details of a new Web server. In case you are modifying the details of an existing Web server, Cancel resets the fields to its original settings. Click Help to open help for the **Web Server Details** screen.

Modifying Web Server Details

The administrator can modify any of the following servlet options:

- Primary WEB Server Selection / De-Selection
- Local Path
- Enabling or Disabling Shared Storage
- Enabling or Disabling FTP/SFTP
- FTP Drive
 - Changes to any of the above would require all the old files to be manually transferred to the new location.
 - The accessibility to the WEB server using the Id / password will be confirmed before saving.

Configuring Database Details

Currently Distributed Data warehouse is also supported with the Application server being in a single machine. Only Atomic Databases can be distributed across machines, not the Infrastructure Config schema. Multiple Atomic databases on a single machine (i.e., multiple SID's) are also supported. The Infrastructure DB components are however

installed only on the DB server and are not distributed across machines.

1. Single tier Infrastructure Install with multiple Information domains hosted on different machines

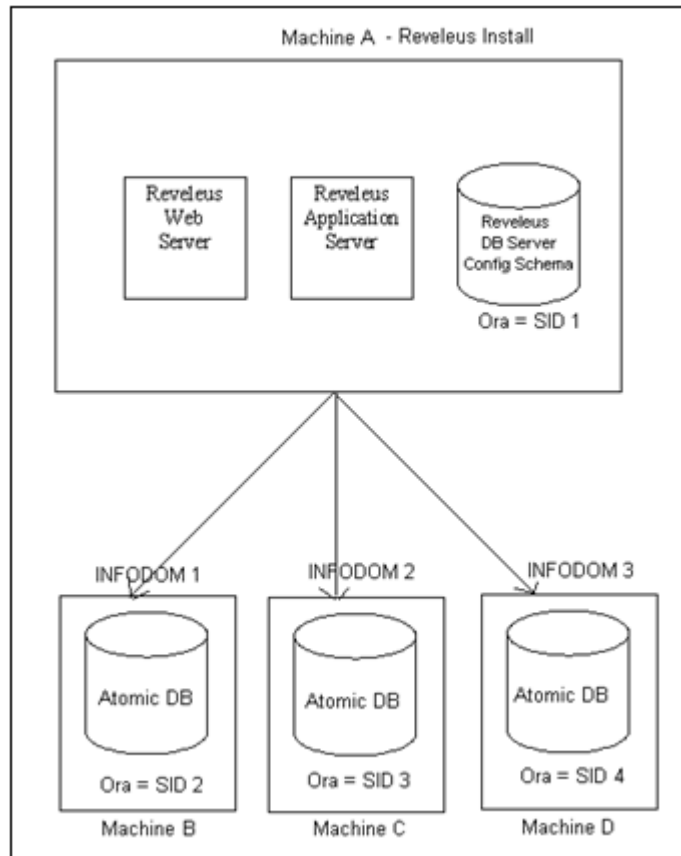

2. Multi-tier Infrastructure Install with Multiple Information domains hosted on different machines.

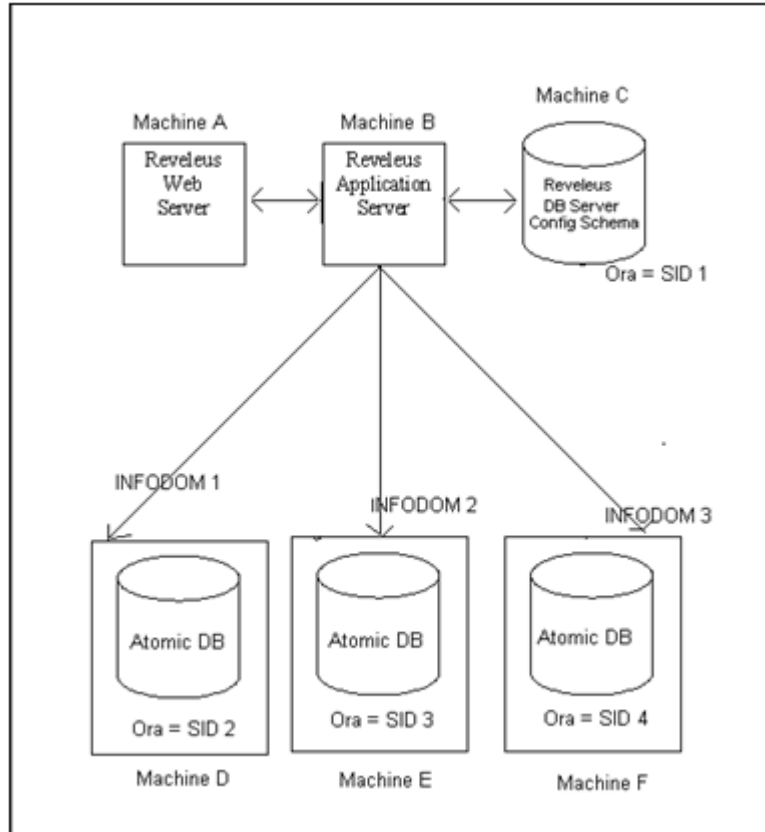

3. Single tier Infrastructure Install with single Information domain on the same machine.

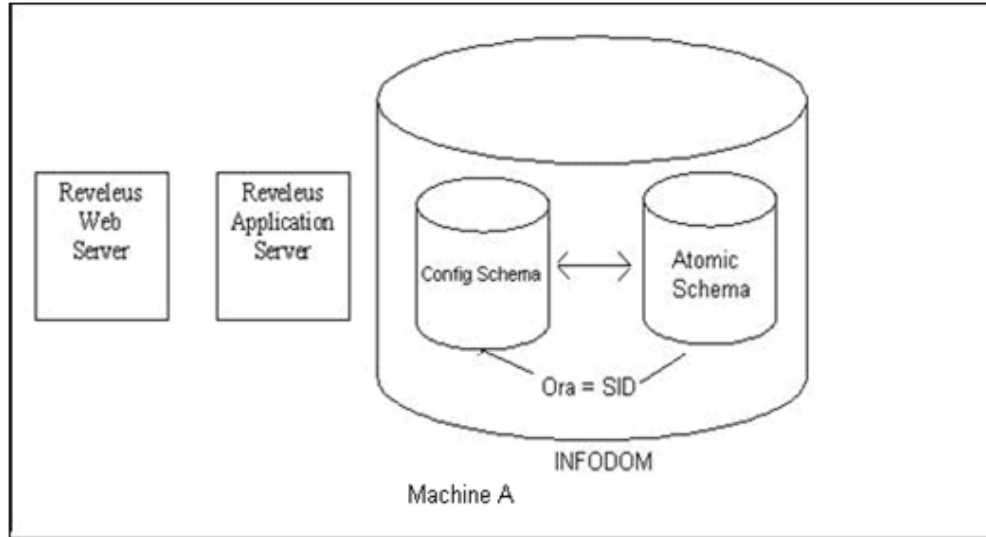

- The Config Schema & Atomic Schema is created under the same SID in Infrastructure DB Server.

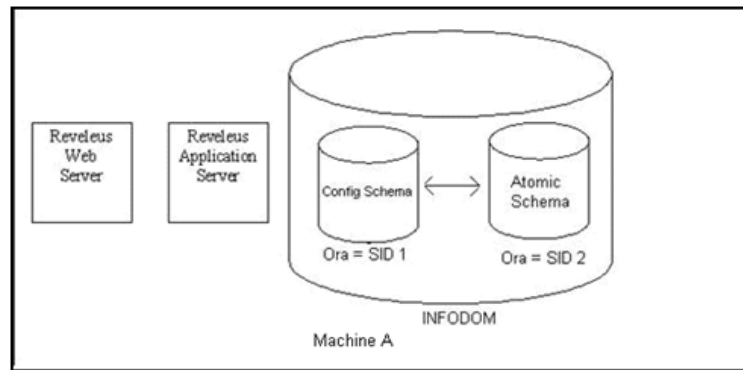

- There are two Oracle instances on the machine. Config Schema is installed under one of the SID where as Atomic Schema is created under the 2nd SID in Infrastructure DB Server.
4. Multi tier Infrastructure Install with single Information domain on the same machine as Infrastructure DB Server.

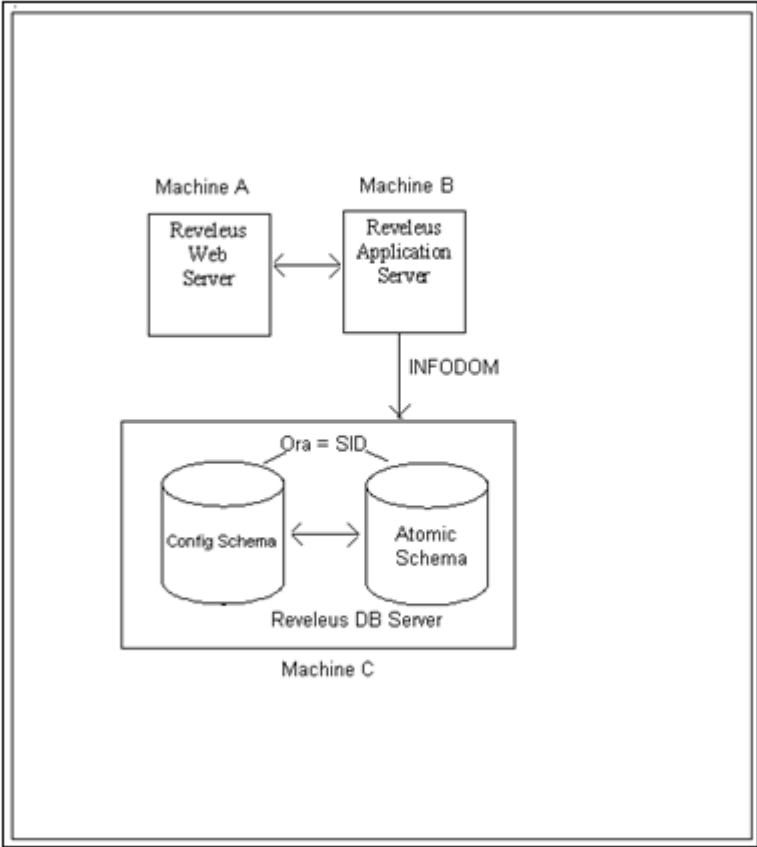

- The Config Schema & Atomic Schema is created under the same SID in Infrastructure DB Server.

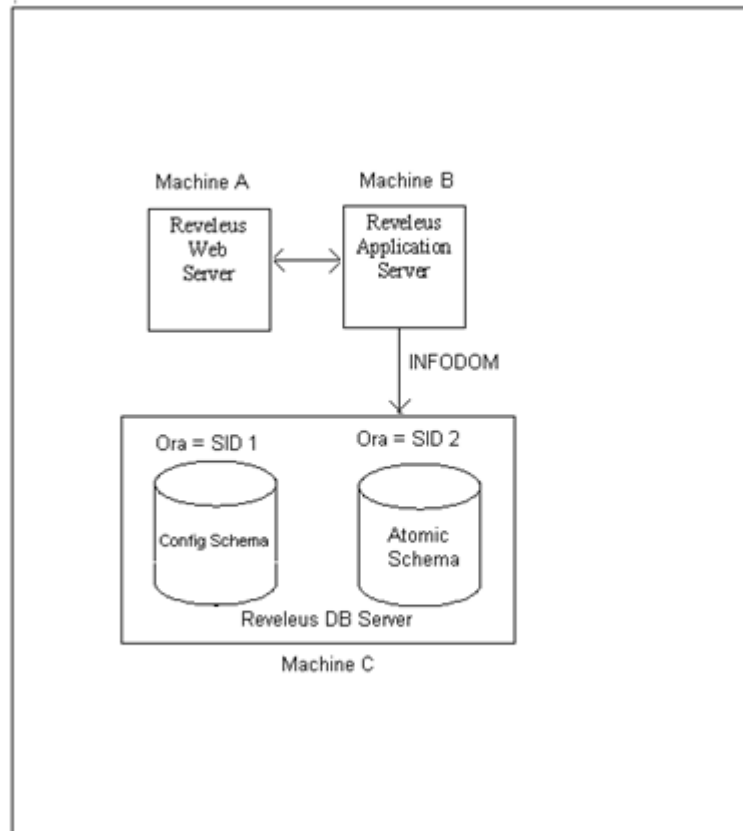

- There are two Oracle instances on the machine. Config Schema is installed under one of the SID where as Atomic Schema is created under the 2nd SID in Infrastructure DB Server.

OFSAA Tablespaces

A tablespace consists of one or more datafiles. OFSAA installation requires a minimum of two tablespaces with the naming conventions listed in the following table:

Tablespace Name	Contents and Usage
DATA_TS	Location of the OFSAA tables.
INDEX_TS	Location of the OFSAA indexes.

You also need to define a temporary tablespace and a rollback tablespace. The

recommended naming convention for these tablespaces is TEMP_TS and ROLLBACK_TS respectively.

Instrument tables such as FSI_D_MORTGAGES, FSI_D_TERM_DEPOSITS, FSI_D_LOAN_CONTRACTS or LEDGER_STAT can be moved from the DATA_TS to different tablespaces, depending on performance requirements. User can use table partitioning as a method of placing segments of a table's data into different tablespaces.

Indexes on the above tables can be created in INDEX_TS tablespace.

- The DATA_TS tablespace is currently only required by the Asset Liability Management (ALM) application.
- The DATA_TS tablespace is only used to create new output tables for ALM process execution. Atomic schema tables created prior to installation of ALM application need not be moved to DATA_TS tablespace.
- The DATA_TS tablespace should not be created as locally managed.
- Atomic schema user needs to have adequate quota on DATA_TS to create output tables for ALM process execution.

OFSAA Datafiles

Examples of the naming conventions for datafiles associated with each of the required tablespaces are provided in the following table:

Tablespace Name	Naming Convention Example
DATA_TS	<dbname>_DATA_01.DBF
	<dbname>_DATA_02.DBF
INDEX_TS	<dbname>_INDEX_01.DBF
	<dbname>_INDEX_02.DBF

Follow the numbering convention in this example for multiple datafiles within tablespaces. The number of datafiles for a tablespace can vary from database to database.

Datafile Location

The location of the datafiles for your tablespaces varies based on many factors, including whether your database is on raw devices or file systems.

If the database is on raw devices the datafiles are defined by a logical volume management program such as Volume Manager and must be mapped into logical

volumes.

If the database is on file systems, the datafiles are located in directories that can use the following naming conventions: /db/d02/oradata/<dbname>, /db/d03/oradata/<dbname>, /db/d04/oradata/<dbname>, and so forth. The datafiles are located in the **oradata/<dbname>**subdirectory.

Adding Database Server Details for DB Server

After you have specified server details, you will have to provide database details for the database(s) configured on the machine. Click the Database Details sub-function from the function menu. The Database Details for DB Server screen is displayed. By default, the database server name defined during set-up is displayed.

The fields that the administrator defines in this screen are described below.

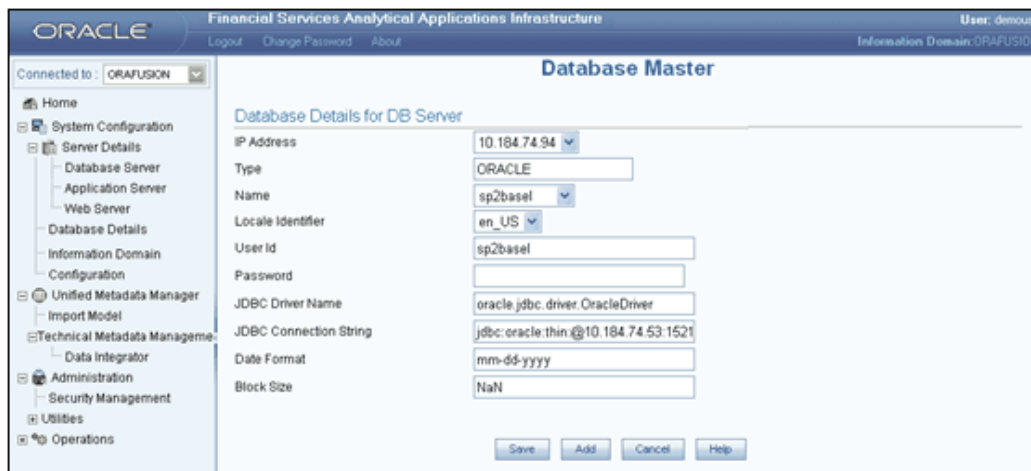

The screenshot shows the Oracle Financial Services Analytical Applications Infrastructure (OFSAAI) Database Master interface. The main window is titled "Database Master" and displays the "Database Details for DB Server" configuration form. The form includes the following fields:

Field	Value
IP Address	10.184.74.94
Type	ORACLE
Name	sp2basel
Locale Identifier	en_US
User Id	sp2basel
Password	
JDBC Driver Name	oracle.jdbc.driver.OracleDriver
JDBC Connection String	jdbc:oracle:thin:@10.184.74.53:1521
Date Format	mm-dd-yyyy
Block Size	NaN

At the bottom of the form, there are four buttons: Save, Add, Cancel, and Help.

In the Add mode, the database machine name or the IP address will be displayed in the drop-down list. The database type will be the same for an installation and therefore this field cannot be edited. The database name, user id and password should be entered in the respective areas. The Database Administrator should ensure that there is a TNS entry for the Database name provided. The Database name provided should be the name of the Atomic Schema. The TNS entry should be added to the \$ORACLE_HOME/network/admin/tnsnames.ora file, located in the machine where Oracle database server is installed.

For example:

```

Atomic Schema: OFSAAATOMIC
SID: OFSAA

tnsnames.ora entry to add:

OFSAAATOMIC =
  (DESCRIPTION =
    (ADDRESS = (PROTOCOL = TCP) (HOST = ofsasupport-1xn4) (PORT = 1521))
    (CONNECT_DATA =
      (SERVICE_NAME = OFSAA)
    )
  )

```

Specifying the IP Address

Select the Database IP Address from the IP Address drop-down list. This list will display the database server IP address defined during the set-up.

Example

10.80.50.226

Selecting the Database Type

The Database Type will be the same for an installation and is populated automatically based on the IP address selection. This field cannot be modified.

Specifying the Database Name

The name entered should match the Atomic Schema User from the database. This should be in-line with the database created by the user in the database server.

Enter the Database name in the Name field or select it from the drop-down list.

Example

ofsaaatomic

Specifying the Locale Identifier

The **Locale Identifier** value is identified at the localization set-up. The user simply has to select the value.

Example

en_US

Specifying the User Id

In the User Id field, enter the User Id that will authenticate the access to the database.

Example

pqatest

Specifying the JDBC Driver Name

The default JDBC Driver Name and the connection string are provided by the application depending on the database type in the fields provided for JDBC driver/JDBC connection string.

If the database type is **Oracle** then the JDBC Driver Name will be `oracle.jdbc.driver.OracleDriver`.

If the database type is **SQLServer** then the JDBC Driver Name will be `com.merant.sequelink.jdbc.SequeLinkDriver`.

If the database type is **DB2UDB** then the JDBC Driver Name will be `com.ibm.db2.jdbc.net.DB2Driver`.

Note: The user can modify the same. No validations will be performed.

The JDBC Connection string

If the database type were Oracle, then the Connection string will be:
`jdbc:oracle:thin:@<<DB Server IP Address>>:<<Oracle PortNumber>>:<<SID>>`

The user would have to provide the Port number where Oracle is running like 1521 and the SID like ORCL.

If the database type is **SQL Server**, then the Connection string will be
`jdbc:sequelink://<<DB Server IP Address>>:<<Port>>; databaseName=<<DBName>>`

If the database type is **DB2UDB** then the Connection string will be
`jdbc:db2://<<DB IP Address>>/<<dbname>>`

The user will have to fill in the details of the fields within << >>

Specifying the Date Format

Enter the Date Format of the database in the **Date Format field**.

Example

`mm-dd-yyyy`

Specifying the Block Size

If the selected database type is Oracle, then the user has to provide the Block Size. This would be set in the INIT.ORA for that instance.

Grants to be given to the Infodom schema user before creating Infodom

Each Information Domain will be created in a separate Atomic Schema. The Oracle database Atomic Schema User should have the following grants:

```
grant create session to <Atomic Schema user>;
grant select on sys.v_$parameter to <Atomic Schema user>;
grant select on sys.dba_free_space to <Atomic Schema user>;
grant select on sys.dba_tables to <Atomic Schema user>;
grant select on sys.Dba_tab_columns to <Atomic Schema user>;
grant select any INDEX to <Atomic Schema user>;
grant create any PROCEDURE to<Atomic Schema user>;
grant create any RULE to <Atomic Schema user>;
grant create any SEQUENCE to <Atomic Schema user>;
grant create any SYNONYM to <Atomic Schema user>;
grant create any TABLE to <Atomic Schema user>;
grant create any TRIGGER to <Atomic Schema user>;
grant create any VIEW to <Atomic Schema user>;
grant create any TYPE to <Atomic Schema user>;
grant create SYNONYM to <Atomic Schema user>;
grant create TABLE to <Atomic Schema user>;
grant create TRIGGER to <Atomic Schema user>;
grant create TYPE to <Atomic Schema user>;
grant create VIEW to <Atomic Schema user>;
grant drop any INDEX to <Atomic Schema user>;
grant drop any PROCEDURE to <Atomic Schema user>;
grant drop any RULE to <Atomic Schema user>;
grant drop any SEQUENCE to <Atomic Schema user>;
grant drop any SYNONYM to <Atomic Schema user>;
grant drop any TRIGGER to<Atomic Schema user>;
grant drop any TYPE to <Atomic Schema user>;
grant drop any VIEW to <Atomic Schema user>;
grant drop any TABLE to <Atomic Schema user>;
```

In addition, as the Information Domain Schema or Atomic Schema uses some of the

tables from the Config schema, ensure to provide the below grants to the Atomic Schema user from the Config Schema user before the Information Domain is created. This will ensure the capability to view the "Security" based Analytics reports from the Administrative Reports.

Execute the following grants from the Config Schema user:

```
grant select on CSSMS_USR_PROFILE to <Atomic Schema user>;
grant select on CSSMS_ROLE_MAST to <Atomic Schema user>;
grant select on CSSMS_GROUP_MAST to <Atomic Schema user>;
grant select on CSSMS_FUNCTION_MAST to <Atomic Schema user>;
grant select on CSSMS_USR_GROUP_MAP to <Atomic Schema user>;
grant select on CSSMS_USR_GROUP_DSN_SEG_MAP to <Atomic Schema user>;
grant select on CSSMS_ROLE_FUNCTION_MAP to <Atomic Schema user>;
grant select on CSSMS_GROUP_ROLE_MAP to <Atomic Schema user>;
grant select on CSSMS_SEGMENT_MAST to <Atomic Schema user>;
```

Modifying Database Details for DB Server

In the Edit mode the user can change/edit all the details except the database type and the database name.

A change in date format does not have any impact on the following:

- Database date format need to be changed manually. (The NLS_DATE_FORMAT of the database need to be changed manually in the database parameters. For e.g. for the Oracle DB, the Init.ora file needs to be changed and the Oracle database needs to be restarted).
- If this value matches the data format in the excel format to_date function translation will not be performed at the time of data loading.

Click Save to save the database details for the DB server that you have defined. Click Cancel to exit the screen without saving the database server details.

Configuring an Information Domain

An Information Domain is the area of analysis. It forms the backbone for all the analysis inside Infrastructure . It is the knowledge domain where information is stored, which consists of specific data models, Technical and Business definition of data to help in processing data for analysis.

This option helps the user to define an Information domain and related maintenance details.

Click the Information Domain sub-function within the System Configuration function menu to display the Information Domain Maintenance screen, which displays details of defined information domains.

The screenshot shows the 'Information Domain Maintenance' interface. At the top, the title 'Information Domain Maintenance' is displayed in blue. Below it, the section 'Information Domain Details' is shown. The 'Name' field is a dropdown menu with 'FSGBUQQA' selected. The 'Description' field contains the text 'fsgbupqa'. There are two checkboxes: 'Is authorization required for Business Metadata?' which is checked, and 'Is this a Staging Information Domain?' which is unchecked. At the bottom of the form, there are six buttons: 'Add', 'Next>', 'Save', 'Delete', 'Cancel', and 'Help'. Below the buttons, there is a table with two rows of metadata:

Created By : SYSADMIN	Date : July 8, 2009 11:44:10 AM
Last Saved By : DEMOUSER	Date : July 8, 2009 3:24:30 PM

This screen is displayed in two modes - Add and/or Edit.

- The Information Domain screen cannot be accessed until the Server details are complete and at least one database has been created.
- One information domain can be mapped to only one database and one database can have only one information domain mapped to it.
- When the user accesses the screen for the first time, the screen will open in the add mode.

Adding Information Domain Details

The **Add** option is enabled only when a database is defined and not mapped to any information domain. Click Add to create a new Information Domain.

Specifying the Information Domain Name

Enter the name of the information domain that you are creating in the **Name** field.

Example

BASELSOL

Specifying the Description

Enter the description of the Information Domain you are creating in the Description field. This should be the full name or the detailed description about the Short name given for the Information Domain.

Example

baselsol

Authorizing Business Metadata, Specifying Staging Details, Replicating the existing Information Domain

There is no specific functionality attached for these features in the present release and it should be the same as default selection.

Click **Next>** to go to the next screen. You are required to enter Database Details in this screen.

Adding Database Details

In the **Database Details for DB Server** screen, two sets of drop-down lists will be displayed. The first lists all the database servers configured for the application and the second will display the databases contained in the machine. The mapping between the databases and the information domain is created.

Selecting the Database Server

Select the name of the **Database Server**, from the drop-down list containing all the available database server names.

Example

10.80.50.226

Selecting the Database Name

Select the **Database Name** from the drop-down list that contains all the available databases defined under database details option.

Example

Basel2

Selecting the OLAP Server, Type and Defining BI Hierarchy Details

There is no specific functionality attached for these features in the present release and it should be the same as default selection.

Click **Next>** to display the next screen of the wizard. In the next screen, the user is required to define paths in the APP Server / DB Server

Paths on the APP Server / DB Server

One information domain should be mapped to one database. The details provided for the database and the machine details will be mapped to the information domain. A consolidated data would be stored in the DSNMASTER table in the Config schema database.

Note: On saving an Information Domain the following tables will be created in the Atomic database, mapped to this information domain.

- bp_meas_map
- cubedetails
- exceptions
- fsi_data_type_desc
- fsi_db_info
- fsi_engine_lookup
- fsi_message_log
- fsi_m_auto_balancing
- fsi_m_lookup_b
- fsi_m_lookup_master
- fsi_m_lookup_tl
- fsi_m_object_definition_b
- fsi_m_object_definition_tl
- fsi_m_object_defn_comments
- fsi_process_errors
- fsi_signage_cd
- fsi_signage_mls
- rev_app_preferences_metadata
- rev_app_user_preferences

- rev_bihier
- rev_column_properties
- rev_column_property_cd
- rev_column_property_mls
- rev_column_requirements
- rev_cube
- rev_data_filter
- rev_description_tables
- rev_dimensions_b
- rev_dimensions_tl
- rev_dimension_type_code_cd
- rev_dimension_type_code_mls
- rev_dim_attributes_b
- rev_dim_attributes_tl
- rev_dim_mgmt_comments
- rev_expression_details
- rev_fusion_macros
- rev_glbl_preferences_metadata
- rev_glbl_user_preferences
- rev_group_filter
- rev_hierarchies
- rev_hierarchy_filter
- rev_hierarchy_levels

- rev_hier_definitions
- rev_hier_maintanance
- rev_locale_hier
- rev_member_dependencies
- rev_mf_process_output_details
- rev_mf_process_output_master
- rev_model_output_details
- rev_model_output_master
- rev_object_dependencies
- rev_property_columns
- rev_property_stp
- rev_tables_b
- rev_tables_tl
- rev_table_classification_b
- rev_table_classification_tl
- rev_table_class_assignment
- rev_table_class_properties
- rev_table_properties
- rev_tab_columns
- rev_tab_columns_mls
- rev_user_bihier
- rev_user_cube
- rev_virtual_tables
- rev_virtual_tables_mls

- sys_stg_join_master
- sys_tbl_master

If these tables have not been created, there could be a problem in connecting to the database or there may not be enough space in the database. Ensure that there is enough space allocated and then save the information domain.

Adding Paths for APP Server, DB Server and Web Server

The requisite paths for Infrastructure will be created in the database machine on saving it. Based on the FTP/SFTP drive defined by the user in the server detail screen, the path creation will take place.

- Erwin Path, currently referred to as path for Technical Metadata, stores
- TFM and Database Model XML files
- Table Creation scripts
- Log Path, stores the Log files for all the Backend and Front-end components.
- Stage that stores the FLAT file to be loaded through Data Integrator. This is the only path that is not tagged to any Information Domain.

ERWIN and Script Paths are derived from the information given at the time of App Server and DB Server Definition and displayed as default values. This path information can not be modified.

Specifying the Log File Path for APP Server and DB Server

Enter the Log file path in the Application Server and Database Server.

The following paths will be created in the Application server:

- Erwin Path, Scripts Path.

The following paths will be created in the database server:

- Erwin Path, Scripts Path
- The paths are created in the FTP Drive of the respective machines.

Note: On Save Operation, The following paths will be created in the Application server: Erwin Path, Scripts Path, Log File Path and MDB Path.

Example

If the FTP drive were provided as "d:/FICFTP" then the erwin path would be "d:/FICFTP/⟨InformationDomainName⟩/erwin"

The User can specify a complete Log path for the Information domain. This Path can be anywhere in the Database Server. The application should have write rights on that folder. By default the Log path will be NULL.

The requisite paths for Infrastructure will be created in the database machine on saving it.

- The log path will not be created by the Infrastructure . Hence the path should be present in the server before mapping it in the Information Domain screen.
- The user can specify a complete log path for the information domain. This path can be anywhere in the database server. The application should have write rights on that folder. By default the log path will be null.

Click **<Back** to return to the previous screen.

Click **Save** to save the changes entered in the screen or click **Cancel** to refresh the screen without saving the changes made in the screen.

Modifying Information Domain Details

In the Edit mode, the user can change only the information domain description. The Scripts / ERWIN path information cannot be changed; however, it will be changed by the system if the server details have been changed. For the Log and MDB path change, the old files need to be moved manually to the new path.

In this mode, the user can change the following:

- Information Domain Description
- Log File Path

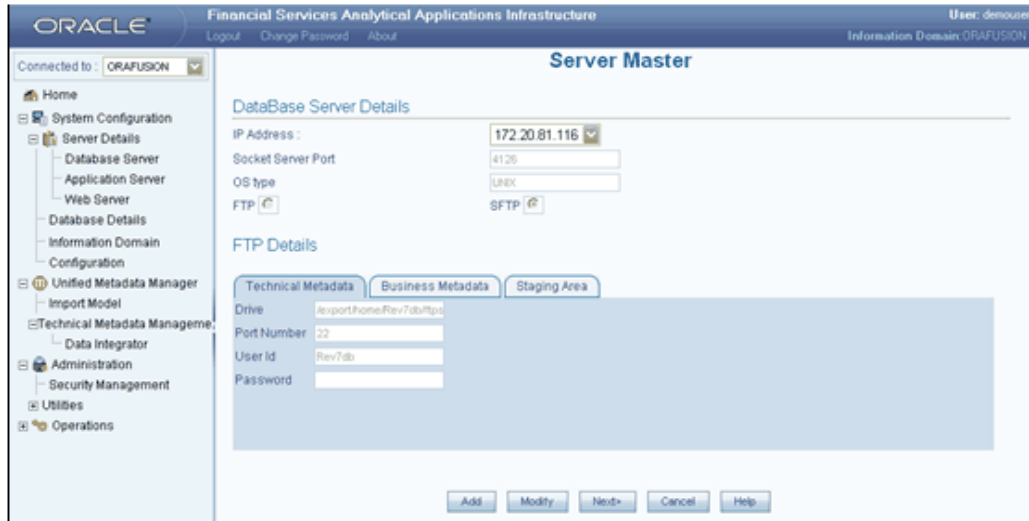

- The Information in this screen cannot be edited. The information is provided only for viewing purposes.
- In a windows distributed architecture, log folder should be created manually in the DB server (i.e. if the APP server and DB server are in two different machines).
- During information domain creation, if the Application server and the DB server are in two different machines the log folder path for the DB server should hold only /ftpshare/ <infodomname>/logpath

Saving Information Domain Details

Consolidated information about the information domain and database mapping would be stored in DSNMASTER table in the ficmaster database.

On saving an Information Domain the following tables will be created in the Atomic database, mapped to this information domain:

- bp_meas_map
- cubedetails
- exceptions
- fsi_data_type_desc
- fsi_db_info

- fsi_engine_lookup
- fsi_message_log
- fsi_m_auto_balancing
- fsi_m_lookup_b
- fsi_m_lookup_master
- fsi_m_lookup_tl
- fsi_m_object_definition_b
- fsi_m_object_definition_tl
- fsi_m_object_defn_comments
- fsi_process_errors
- fsi_signage_cd
- fsi_signage_mls
- rev_app_preferences_metadata
- rev_app_user_preferences
- rev_bihier
- rev_column_properties
- rev_column_property_cd
- rev_column_property_mls
- rev_column_requirements
- rev_cube
- rev_data_filter
- rev_description_tables
- rev_dimensions_b
- rev_dimensions_tl

- rev_dimension_type_code_cd
- rev_dimension_type_code_mls
- rev_dim_attributes_b
- rev_dim_attributes_tl
- rev_dim_mgmt_comments
- rev_expression_details
- rev_fusion_macros
- rev_glbl_preferences_metadata
- rev_glbl_user_preferences
- rev_group_filter
- rev_hierarchies
- rev_hierarchy_filter
- rev_hierarchy_levels
- rev_hier_definitions
- rev_hier_maintanance
- rev_locale_hier
- rev_member_dependencies
- rev_mf_process_output_details
- rev_mf_process_output_master
- rev_model_output_details
- rev_model_output_master
- rev_object_dependencies
- rev_property_columns
- rev_property_stp

- rev_tables_b
- rev_tables_tl
- rev_table_classification_b
- rev_table_classification_tl
- rev_table_class_assignment
- rev_table_class_properties
- rev_table_properties
- rev_tab_columns
- rev_tab_columns_mls
- rev_user_bihier
- rev_user_cube
- rev_virtual_tables
- rev_virtual_tables_mls
- sys_stg_join_master
- sys_tbl_master

If these tables have not been created, there could be a problem in connecting to the database or there may not be enough space in the database. Ensure that there is enough space allocated and then save the information domain.

Important: An Information Domain can be deleted from Infrastructure system, provided there are no users mapped to it and using it.

Configuring Password changes

OFSAA Infrastructure Config Schema password modification in Post Installation

To change the Config Schema password, perform the following steps:

1. Change the "Config" schema user password in the database.
2. Delete the \$FIC_HOME/conf/Reveleus.SEC file.

3. Shutdown the OFSAAI App service:

```
cd $FIC_APP_HOME/common/FICServer/bin
./reveusshutdown.sh
```
4. Start the Infrastructure Server in foreground directly on the server or through X-Windows software using the command:

```
./reveusstartup.sh
```
5. A pop-up window will appear with a prompt "Enter System Password". Enter the new Config schema password. The service will start and initialize itself if it was able to successfully connect to the DB.
6. Post successful startup of the service, if wanted, the Infrastructure server may be shutdown and restarted in the background using nohup mode.

OFSAI Infrastructure Atomic Schema password modification in Post Installation

To change the Atomic Schema password perform the following steps:

1. Login to the application from the browser using "SYSADMIN" account or any user-id which has "System Administrator" role mapped.
2. Change the "Atomic" schema user password in the database.
3. Login to OFSAA.
4. Navigate to "System Configuration -> Database Details" screen. Select the appropriate connection and edit the password.
5. Navigate to "Unified Metadata Manager" -> "Technical Metadata" -> "Data Integrator" -> "Define Sources" screen. Update the appropriate "Source" details.
6. If using Apache Tomcat as Web server, update the "<Context>" -> "Resource" tag details in "Server.xml" file from the "\$CATALINA_HOME/conf" folder. (In case of Tomcat only "Atomic" "<Resource>" will exist.

If using Websphere as Web server, Login to the "Web sphere Administration Console", from the LHS Menu, navigate to "Resources -> JDBC -> Data Sources" . A list of data sources will be populated on the RHS. Select the appropriate "Data Source" and edit the connection details. (In this case both "Config" and "Atomic" data sources will need to be modified.)

If using Weblogic as Web server, Login to the "Weblogic Administration Console", from the LHS Menu, under "Domain Structure" list box, expand the appropriate "Domain" and navigate to "Services -> JDBC -> Data Sources" . A list of data sources will be populated on the RHS. Select the appropriate "Data Source" and edit the

connection details. (In this case both "Config" and "Atomic" data sources will need to be modified.)

7. Restart the OFSAAI services.

Resource Reference Configuration

Configuration of Resource Reference in Infrastructure Application

The web.xml file has to be updated with the Information Domain name as the resource reference name. This is required for connection pooling with the Atomic database schema.

Navigate to \$FIC_WEB_HOME/webroot/WEB-INF.

Add the Information Domain name in the following block of text at the end of the web.xml file.

```
<resource-ref>
<res-ref-name>jdbc/<INFORMATION DOMAIN NAME></res-ref-name>
<res-type>javax.sql.DataSource</res-type>
<res-auth>Container</res-auth>
</resource-ref>
```

Here, <INFORMATION DOMAIN NAME> is the name of the Information Domain you have created.

Note: This block of text must be repeated for each of the information domains that are created.

Configuration of Resource Reference in Websphere Application Server

Creating the JDBC Provider

1. Open this URL in the browser window: `http://<ipaddress>:<administrative console port>/ibm/console`. The login screen is displayed. Login with the user id that has admin rights.

- Expand the Resources option in the left hand screen menu. Click on JDBC > JDBC Providers option. This will display the JDBC Providers page.



- Click New to add new JDBC Provider. The Create a new JDBC Provider screen contains the following. Enter the following mentioned options.

Database Type - Oracle

Provider Type – Oracle JDBC Driver

Implementation Type – Connection pool data source

Name – The required display name for the resource.

Description – The optional description for the resource

Click Next

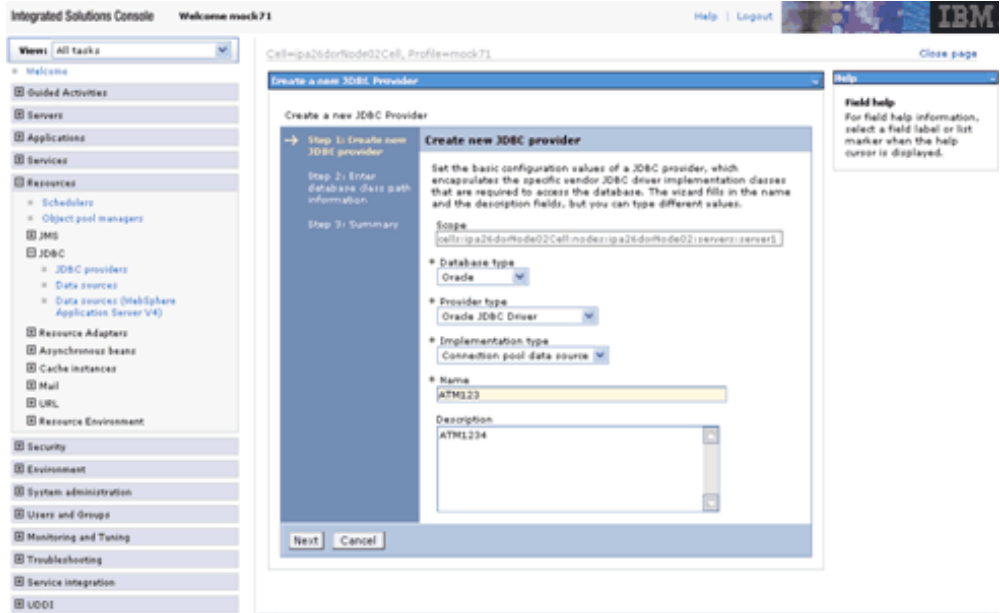

- Specify the directory location for ojdbc6.jar file. Do not use trailing slash file separators. Click Next.

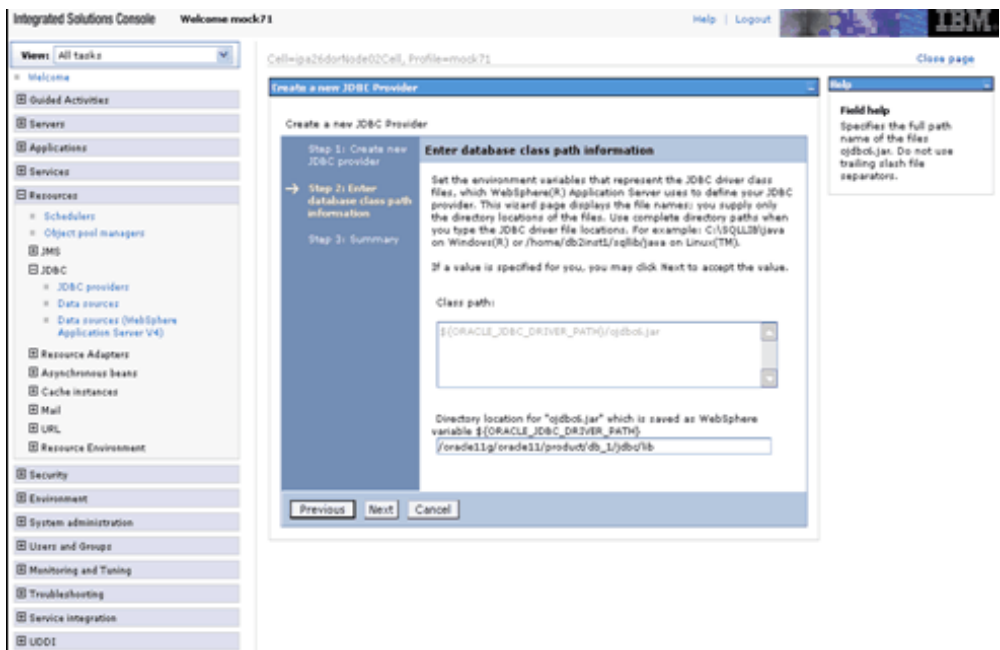

Note: The ojdbc6.jar file can be downloaded from the following URL
http://www.oracle.com/technology/software/tech/java/sqlj_jdbc/htd

ocs/jdbc_111060.html This file can be downloaded and placed in any folder in your system. Make sure that the path to the jar file in this folder is given in the Class path field in the Enter database class path information screen while creating the JDBC Provider.

5. Check the details you have entered and click Finish to create the JDBC Provider.

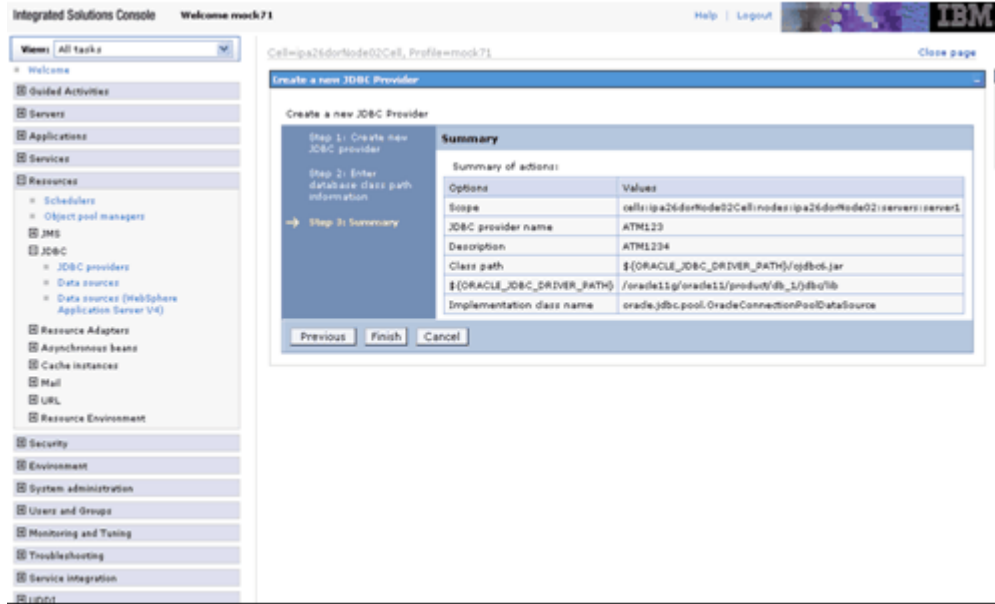

6. The option of Save and Review is displayed. Click Save before proceeding.

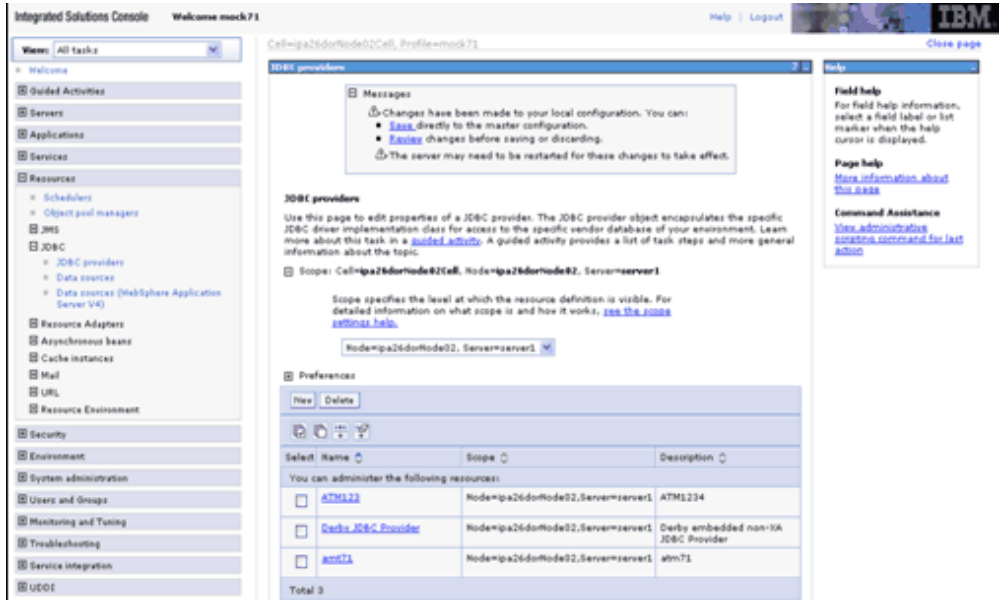

Creating the Data Source in Websphere Application Server

Creating the Data Source

1. Expand the Resources option in the left hand screen menu. Click JDBC > Data sources option. This will display the Data sources page.

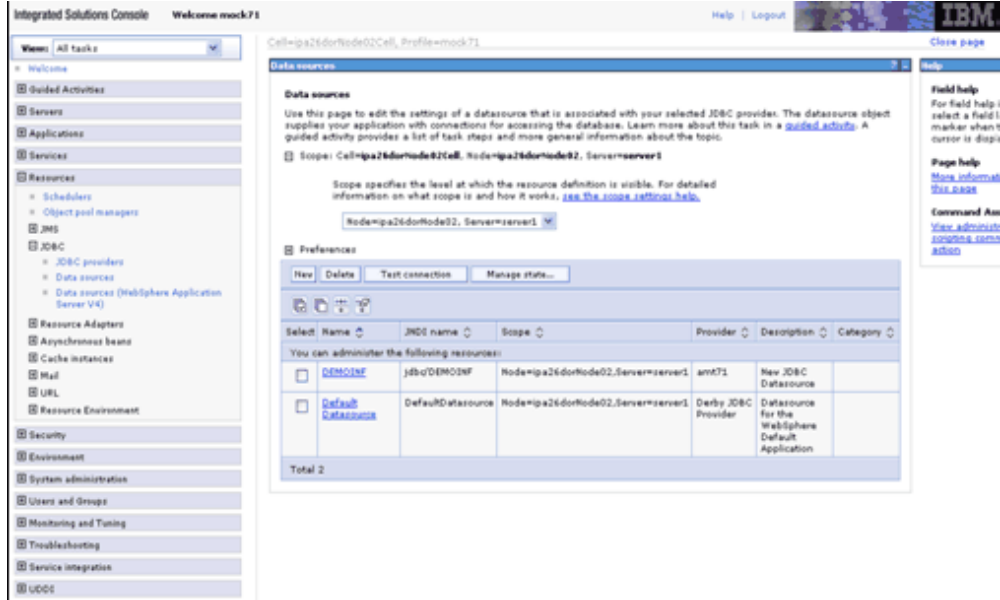

- Specify the Data Source name and the JNDI name for the new data source (the JNDI and Data Source name is case sensitive. JNDI Name should be same as the Infodomain name).

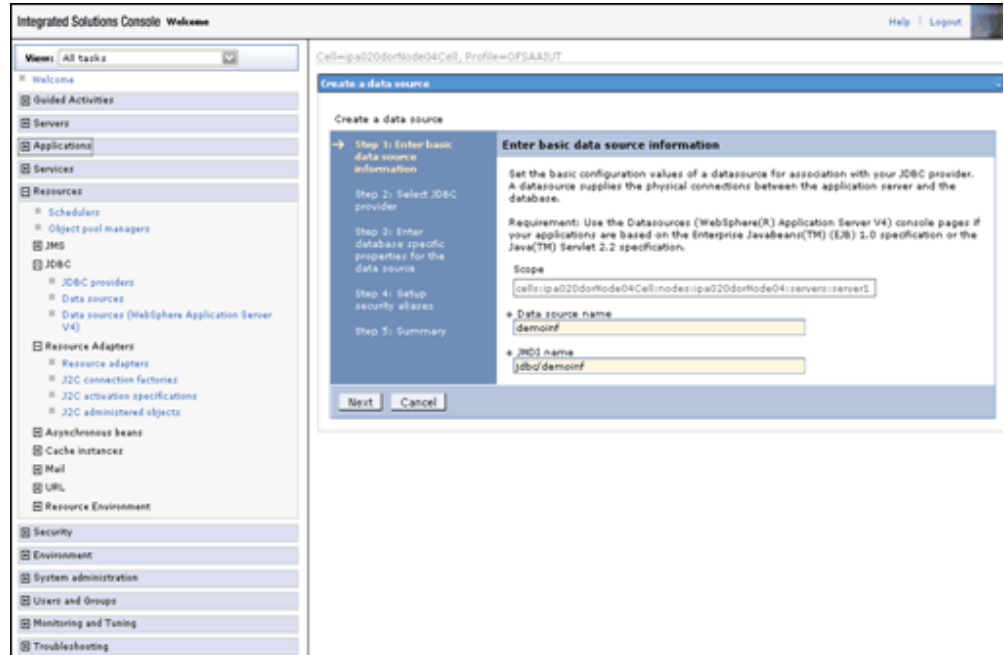

3. Select an existing JDBC provider from a drop-down list which is been created already.

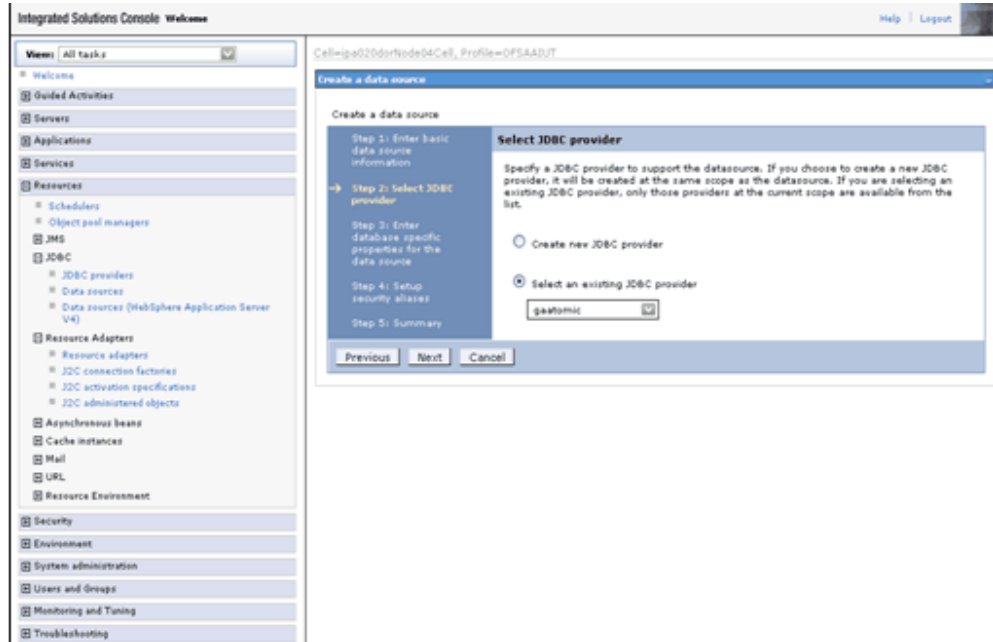

4. Specify the URL of the database from which the data source obtains connections. The connection URI is of the type
jdbc:oracle:thin:@<DB_SERVER_IP>:<DB_SERVER_PORT>:<SID>

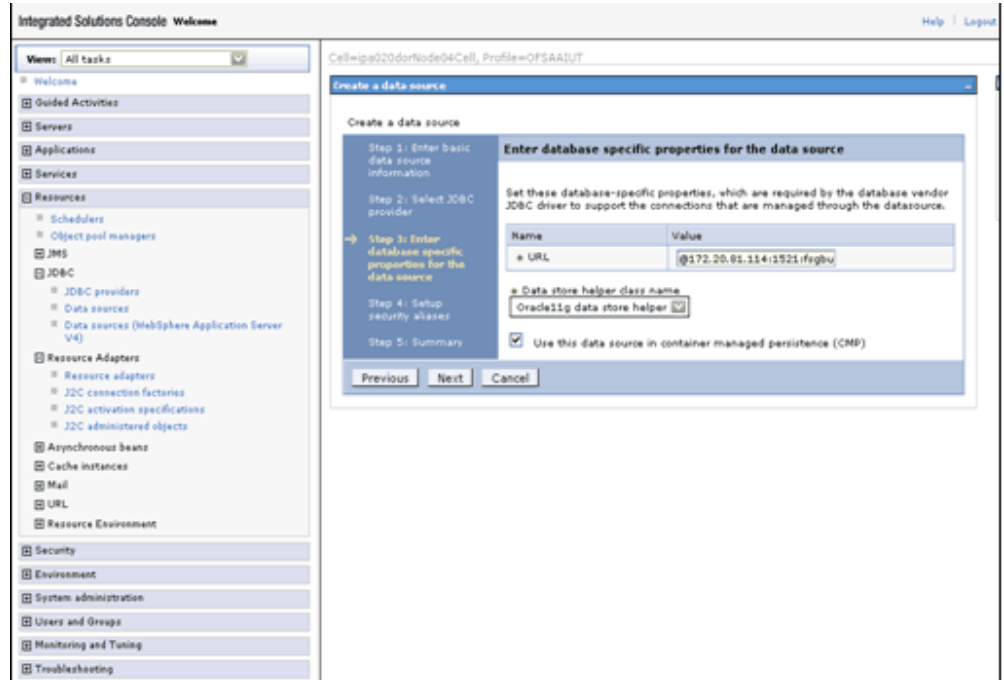

5. Map the J2C- authentication alias, if already created. You can create a new J2C authentication alias by accessing the link given (Global J2C authentication alias) or you can continue with the data source creation by clicking on Next and then Finish.

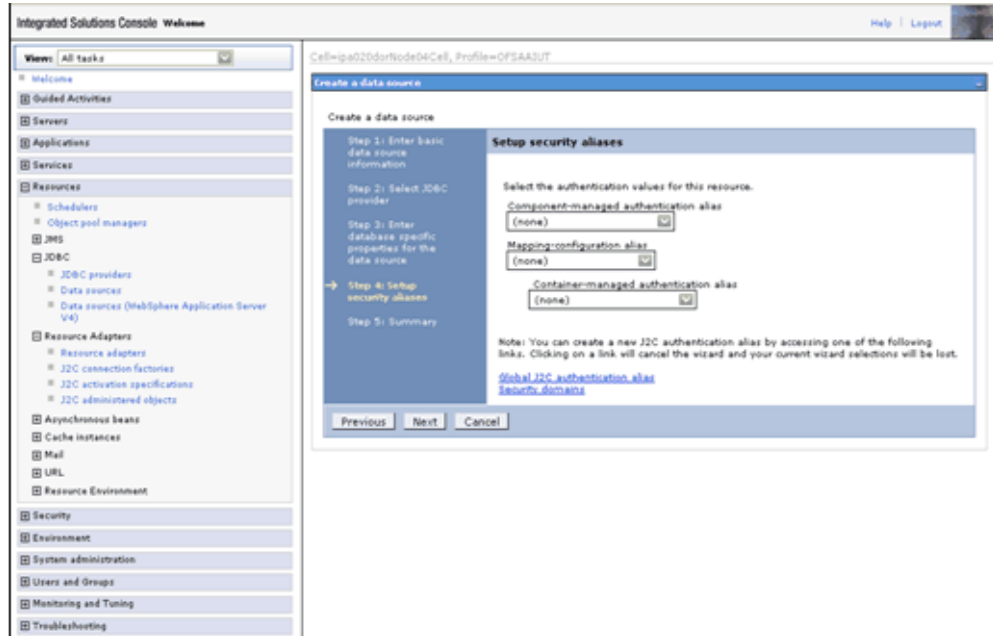

The creation and mapping of J2C authentication alias can be done after the data source creation as well

J2C Authentication Details

Click the newly created Data Source and click the JAAS – J2C authentication data link under Related Items. Click New to specify a list of User IDs and passwords for Java 2 Connector Security to use. Save the input information.

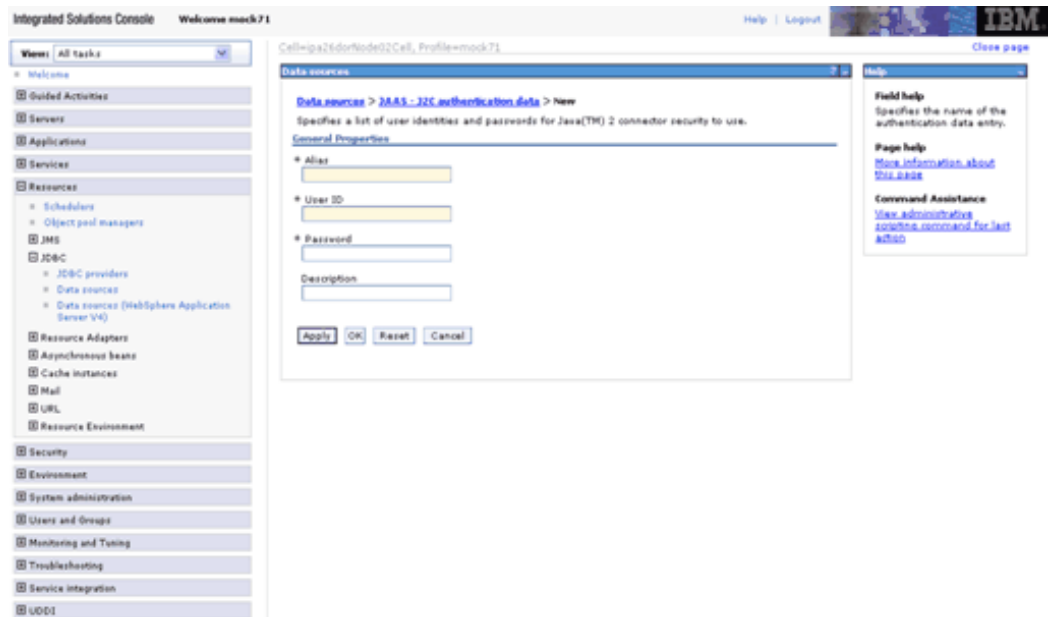
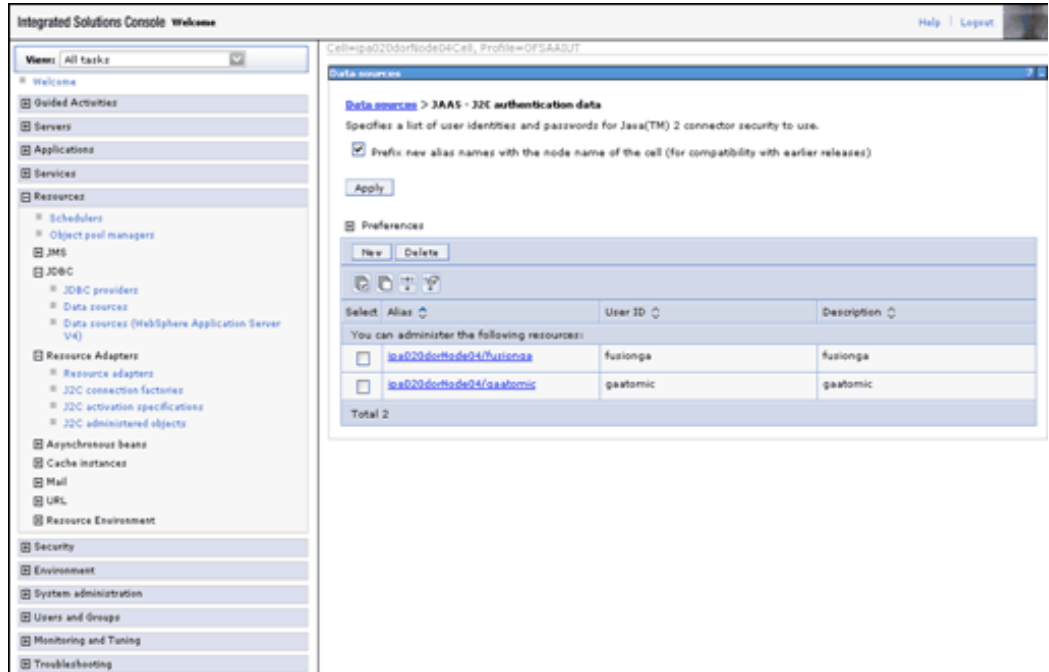

- The User ID to be specified is the Atomic user ID that is created for the respective Information Domain.
- Refer the WebSphere online help (Page Help – More Information about this page link) in the right side of the same screen for more information.

Configuration of Resource Reference in Tomcat Application Server

Copy the ojdbc6.jar from <Oracle Home>/jdbc/lib and place it in <Tomcat Home>/lib.

Configuration of web.xml

The web.xml file has to be updated with the Information Domain name as the resource reference name.

Navigate to \$FIC_WEB_HOME/webroot/WEB-INF.

Add the Information Domain name in the following block of text at the end of the web.xml file.

```
<resource-ref>
<res-ref-name>jdbc/<INFORMATION DOMAIN NAME></res-ref-name>
<res-type>javax.sql.DataSource</res-type>
<res-auth>Container</res-auth>
</resource-ref>
```

Here<INFORMATION DOMAIN NAME>,is the name of the Information Domain name you have created.

Note: • This block of text must be repeated for each of the information domains that are created.

Creating the Data Source in Tomcat Application Server

Navigate to <Tomcat Home>/conf and edit the following block of text in server.xml by replacing the actual values of the text given in bold. This is for creating a data source for the Infrastructure application.

```
<Context path ="/<context name>" docBase="<Tomcat Installation
Directory>/webapps/<context name>" debug="0" reloadable="true" crossContext="true">
<Resource auth="Container"
name="jdbc/< INFORMATION DOMAIN NAME >"
type="javax.sql.DataSource"
driverClassName="oracle.jdbc.driver.OracleDriver"
username="<user id for the database>"
password="<password for the above user id>"
url="jdbc:oracle:thin:@<DB engine IP address>:<DB Port>:<SID>"
maxActive="100"
```

```
maxIdle="30"  
maxWait="10000"/>  
</Context>
```

Note: • The <Resource> tag must be repeated for each of the information domains that are created.

- After the above configuration, the WAR file has to be created and deployed in Tomcat. Refer the Tomcat WAR Files Creation and Tomcat WAR Files Deployment sections for more instructions.

Creating the Data Source in WebLogic Application Server

1. Open this URL in the browser window: `http://<ipaddress>:<administrative console port>/console`. The login screen is displayed. Login with the user id that has admin rights.



2. From the left hand screen menu, under Domain Structure, click Services > JDBC > Data Sources.

The **Summary of JDBC Data Sources** screen is displayed.

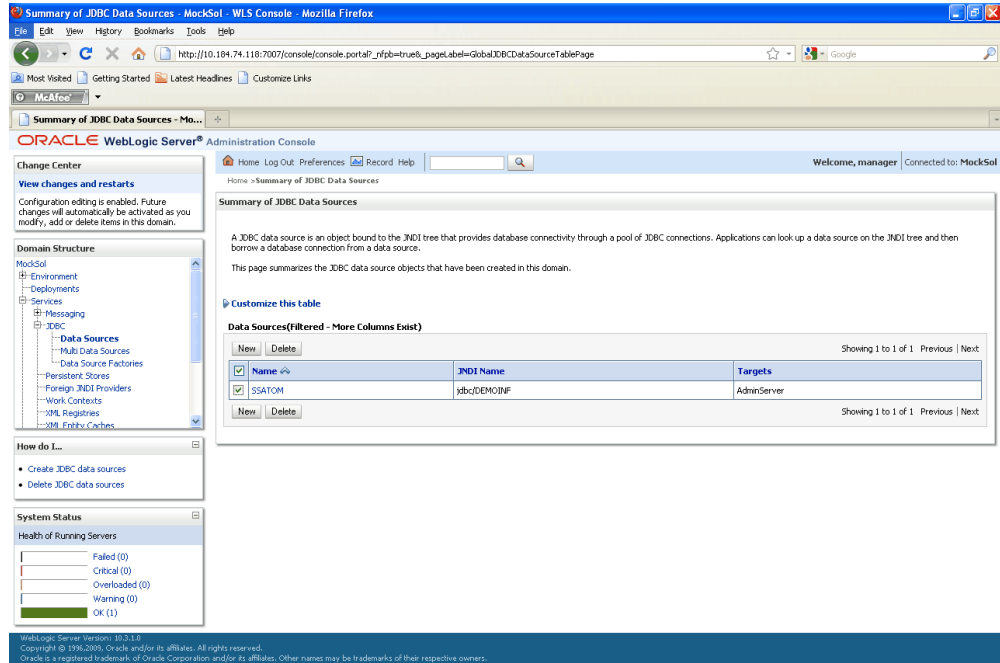

- Click the New button on the right hand side of the screen. The Create a New JDBC Data Source screen is displayed.

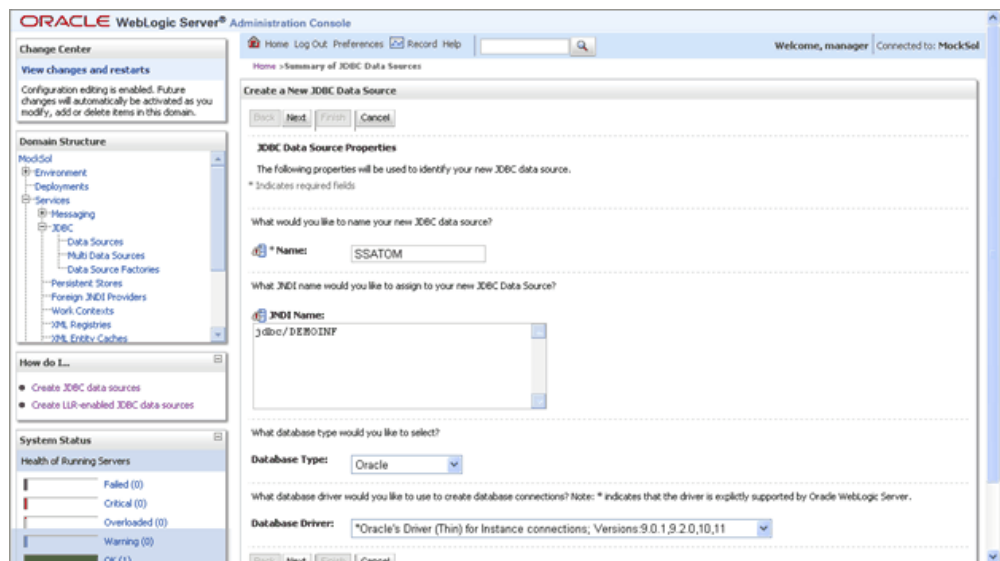

Enter the JDBC source name, JNDI name, Database type and the Database driver name in the respective fields. Click Next.

- The data source name needs to be provided in the Name field.

- In the JNDI Name field, provide the jdbc/infodomainname
4. In the next screen, select the Supports Global Transactions check box and select the One-Phase Commit option.

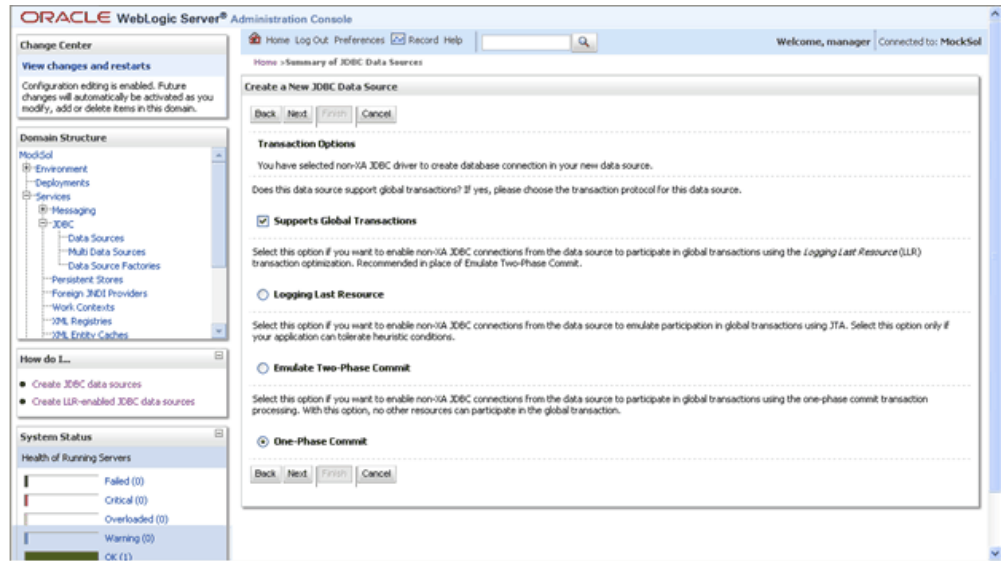

5. Click Next to continue. The Connection Properties screen is displayed.

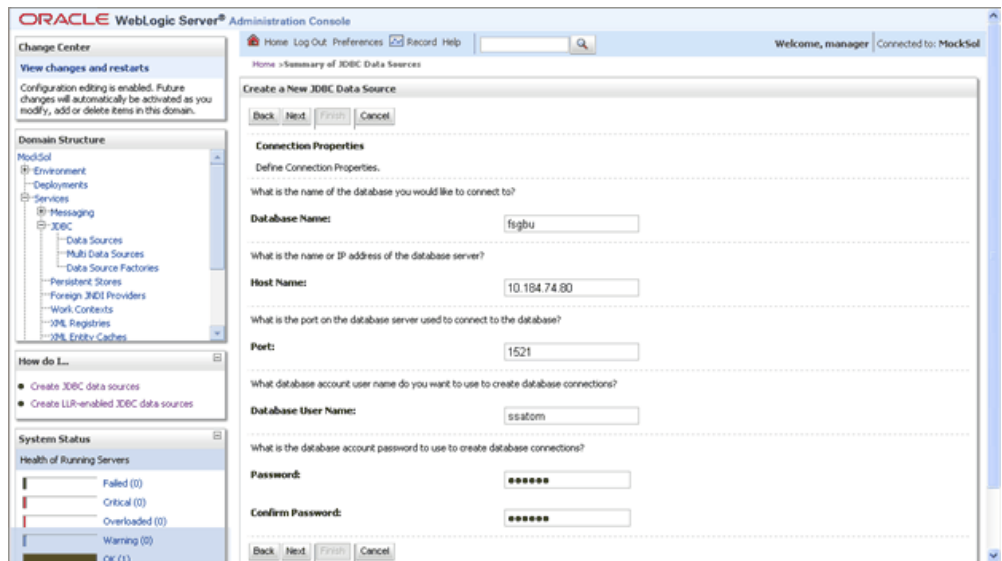

Enter the required details such as the Database Name, Host Name, Port, Oracle User Name and Password and click Next.

6. The Test Database Connection screen is displayed.

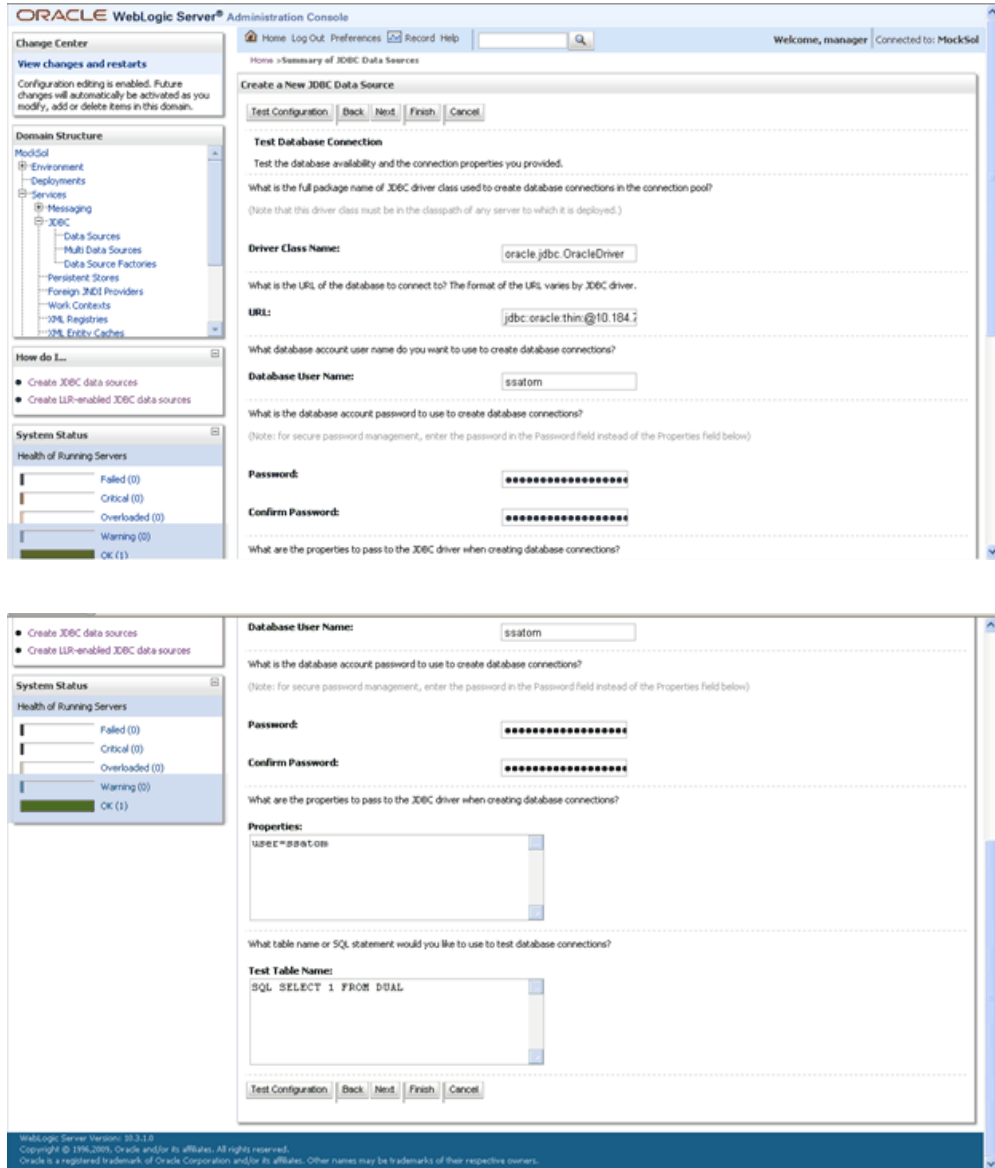

Verify the details displayed and ensure that they are correct. Click Test Configuration to test the configuration settings.

A confirmation message will be displayed stating "Connection test succeeded."

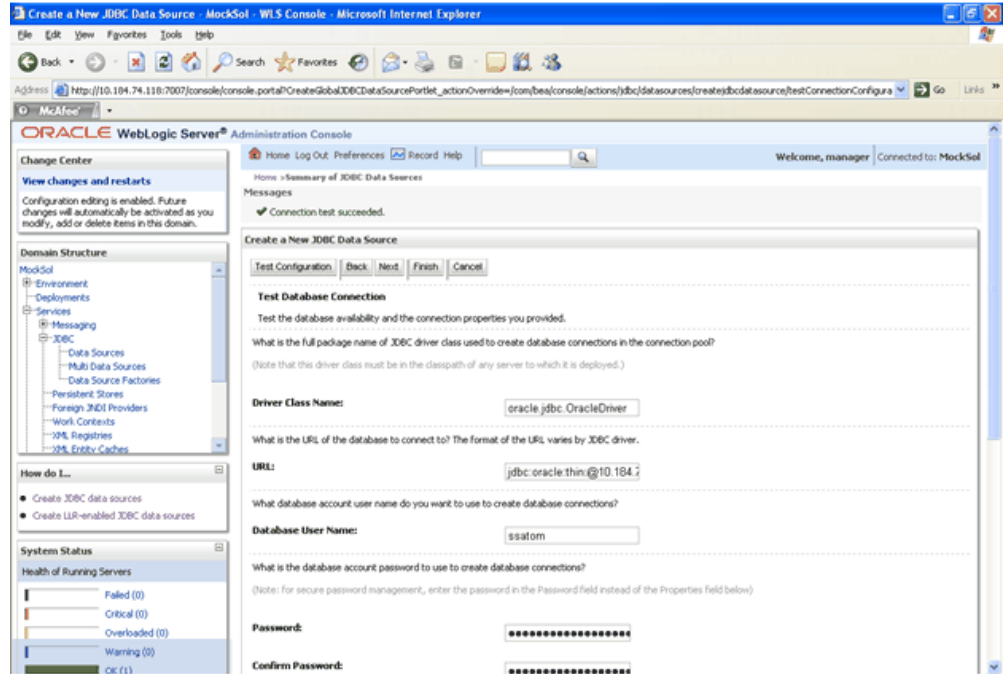

Click Finish. The newly created Data Source will be displayed under the list of Data Sources.

- The User ID to be specified is the Oracle user ID that is created for the respective infodomain.
- Refer the Weblogic online help (Page Help – More Information about this page link) in the right side of the same screen for more information.
- Click on the Data Source created. The Settings for <Data Source Name> screen is displayed.

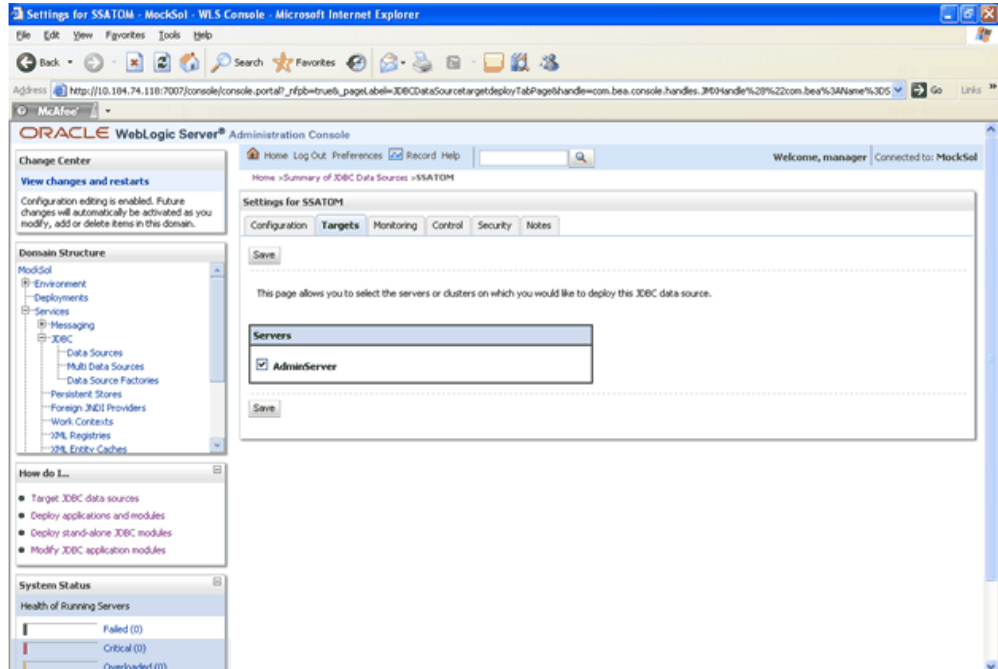

Click the Targets tab and check the AdminServer option.

Click Save.

- Advanced Settings for Data Source.** Click on the Data Source created. The Settings for <Data Source Name> screen is displayed. Select Connection Pooling tab given under Configuration. Go to the Advanced option at the bottom of the page, and check the Test Connection of Reserve checkbox (Enables WebLogic Server to test a connection before giving it to a client).
- To check whether the data source is valid, select the Data Source name (For example 'bdcror').

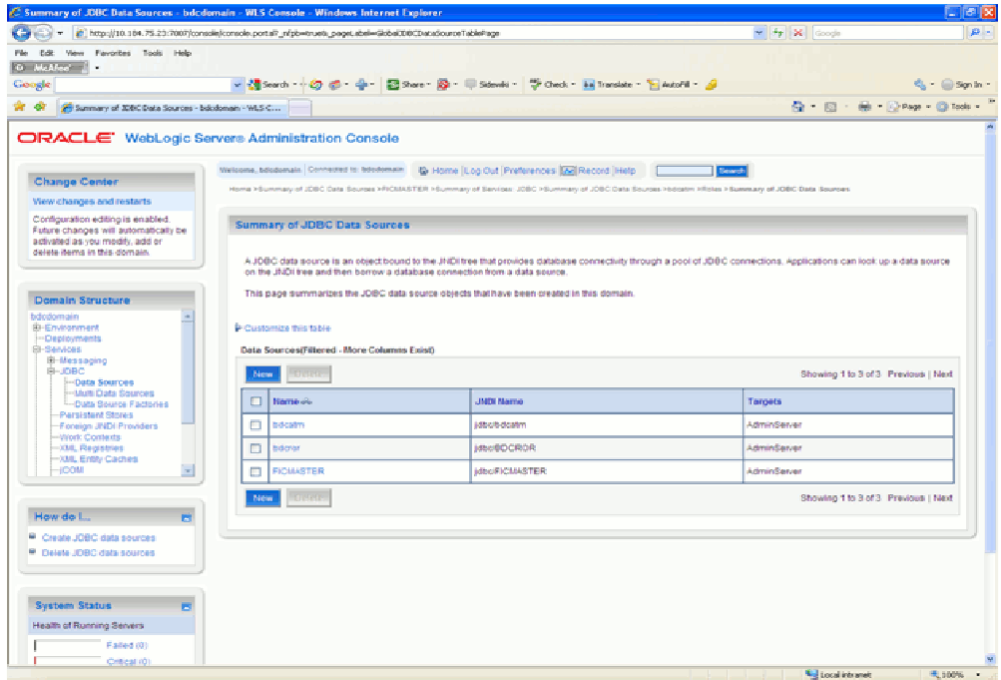

Select the server and click 'Test Data Source'.

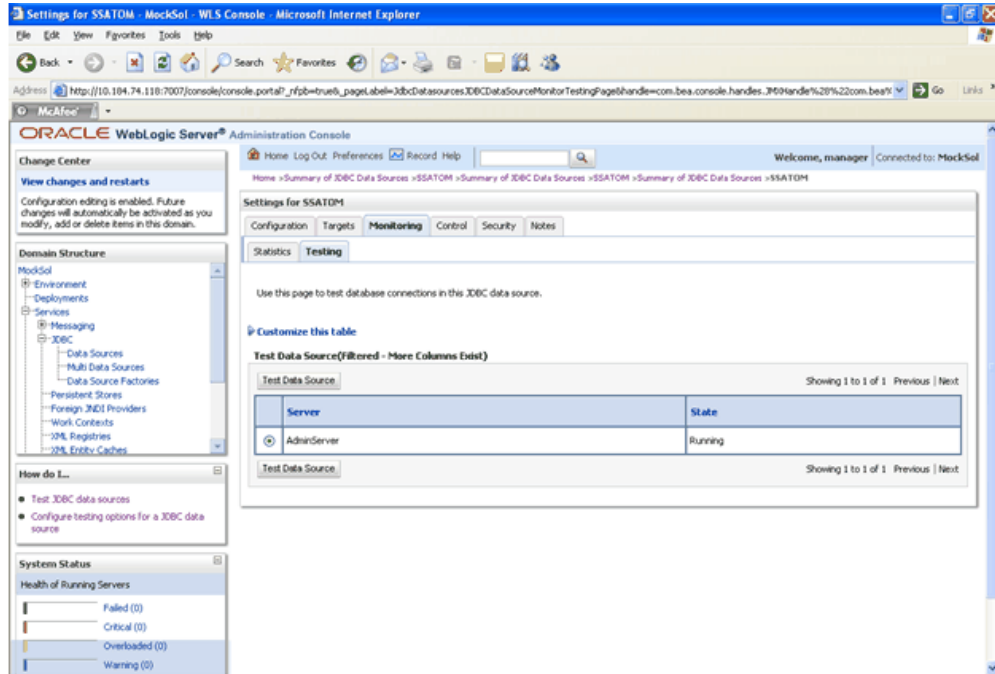

A message comes up stating that the test was successful.

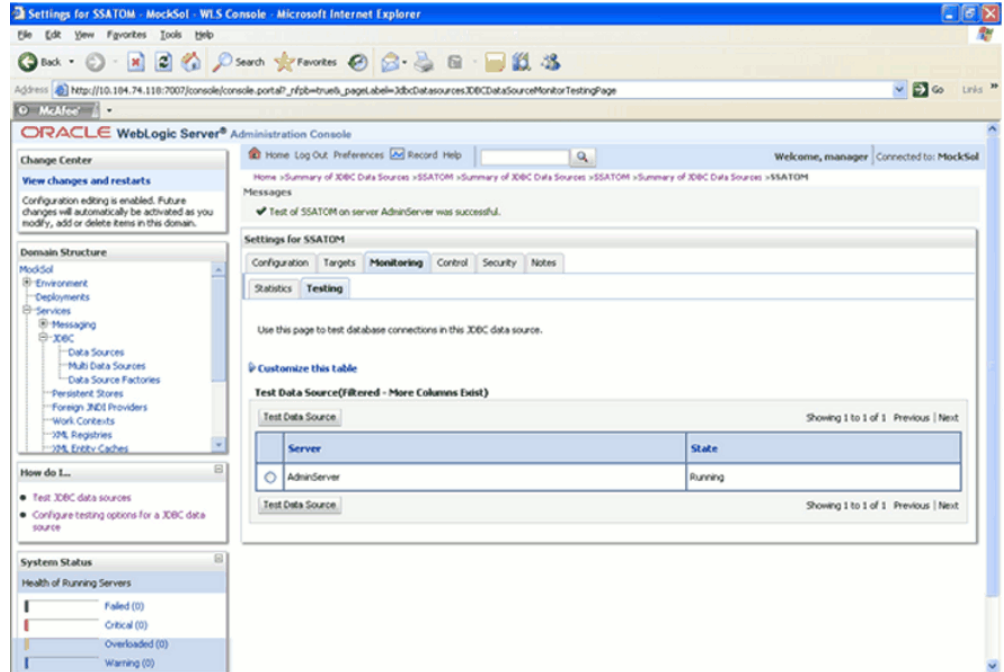

- Two messages appear, "All changes have been activated. No restart is necessary" and "Settings updated successfully". This shows that the Data Source has been created successfully.

If not, follow the steps given above to recreate the data source.

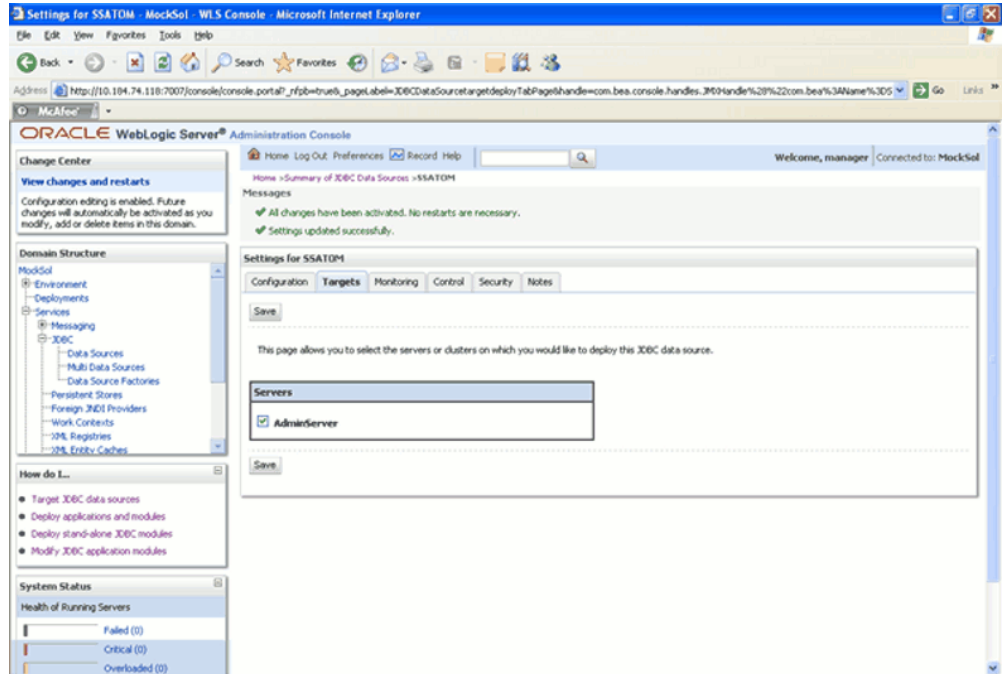

Uninstalling Infrastructure Components

Introduction

The uninstallation process will uninstall all Infrastructure and FS Application related files from the installed directory. Before you start the uninstallation process, ensure that no open connections exist to the Config schema and Infrastructure servers are shutdown.

To uninstall Infrastructure, run the .profile.

Navigate to \$FIC_HOME directory and grant execute permission to UnInstall.sh file.

Execute UnInstall.sh and follow the instructions.

- Uninstallation will not un-deploy the Infrastructure application from Web Server. This has to be done manually.
- The entries in the .profile file will have to be removed manually.
- In case of multi-tier architecture, uninstallation must be performed on all the machines in which Infrastructure components are installed.
- Make sure that no user is connected to the database while uninstalling the Infrastructure Database Layer.
- The Atomic Schema user objects need to be manually dropped (or the entire Atomic Schema) after executing the uninstall.sh file.
- The ftpshare directory and all files need to be manually deleted after executing the uninstall.sh file.

Uninstalling Previously Deployed EAR Files

Following are the steps outlined to uninstall any previously deployed application.

1. Open the URL in the browser window: `http://<ipaddress>:<Administrative Console Port>/ibm/console`. The login screen is displayed. Login with the user id that has admin rights.
2. Expand Applications > Application Types > WebSphere enterprise applications from the left hand screen. The Enterprise Applications screen displays all the deployed applications.

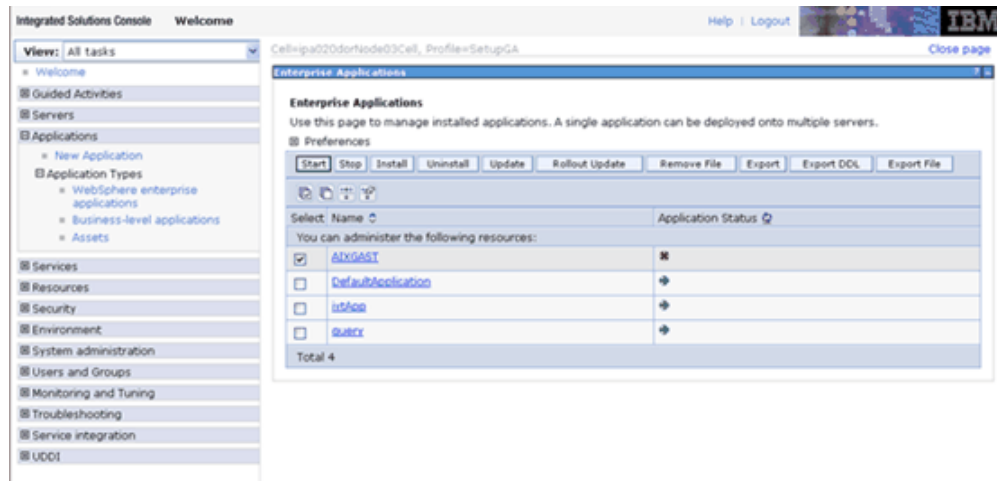

3. Select the application to be uninstalled and click Stop and Uninstall. Click OK to confirm uninstall.



4. Click Save to save the master file configuration.

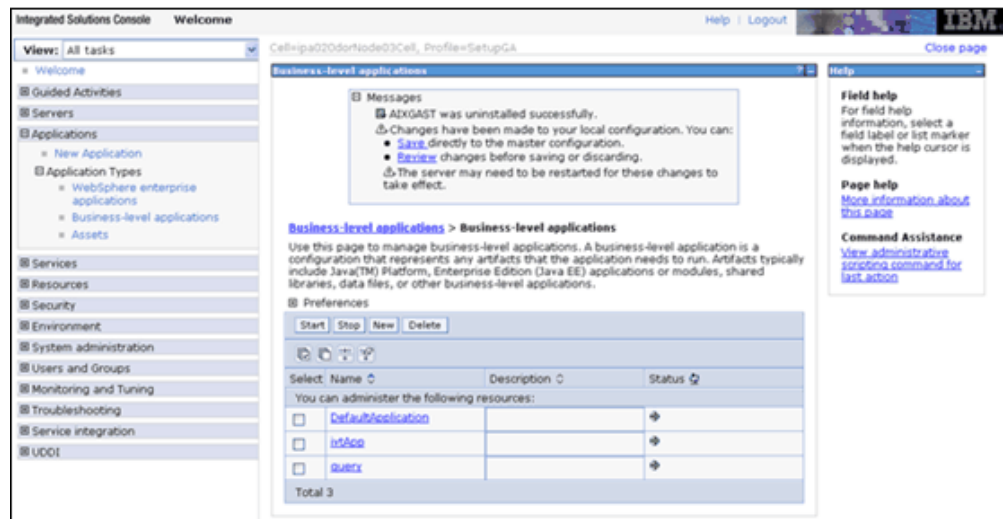

Uninstalling Previously Deployed WAR Files in Tomcat

On the machine that hosts Tomcat, follow the steps outlined to uninstall any previously deployed application.

1. Comment out Context path section from server.xml file in \$CATALINA_HOME/conf directory to avoid conflict during undeploy and re-deploy of the WAR file.

Place comment `<!-- -->` in between the context path section.

For example:

```

<!--
<Context path="/ofsaatom"
docBase="/home/ofsasupport/OFSAA/tomcat/apache-tomcat-6.0.20/webapps/ofsaatom"

debug="0" reloadable="true" crossContext="true">
  <Resource auth="Container"
    name="jdbc/INFODOMNAME"
    type="javax.sql.DataSource"
    driverClassName="oracle.jdbc.driver.OracleDriver"
    username="atomic user"
    password="password"
    url="jdbc:oracle:thin:@10.123.92.19:1521:ofsa"
    maxActive="100"
    maxIdle="30"
    maxWait="10000"/>
  </Context>
-->

```

2. Open the URL in Browser window: <http://<IP address>:<Tomcat server port>>. The Tomcat home page is displayed. Click the 'Tomcat Manager' link on the LHS menu. Login with the user id that has admin rights. (For user creation in tomcat, refer to the section Tomcat User Administration.)
3. This takes you to the Tomcat Web Application Manager. This displays all the applications deployed in Tomcat. Click the Undeploy link against the deployed Infrastructure application. This removes the Infrastructure application deployed.
4. The following screen gives the confirmation message on the application /Infrastructure being undeployed.

Uninstalling Previously Deployed EAR Files in WebLogic

On the machine that hosts Weblogic, follow the steps outlined to uninstall any previously deployed application.

Open the URL in the browser window: `http://<ipaddress>:<admin server port>/console`. The login screen of the WebLogic Server Administration Console is displayed. Login with the WebLogic user id and password having administration privileges. The WebLogic Server Administration Console is displayed.

Click the 'Deployments' link on the LHS menu. The **Summary of Deployments** screen is displayed. To do a new deployment, click Install.

1. To deploy an application on an existing EAR file, stop the service first by clicking Stop > Force Stop Now.

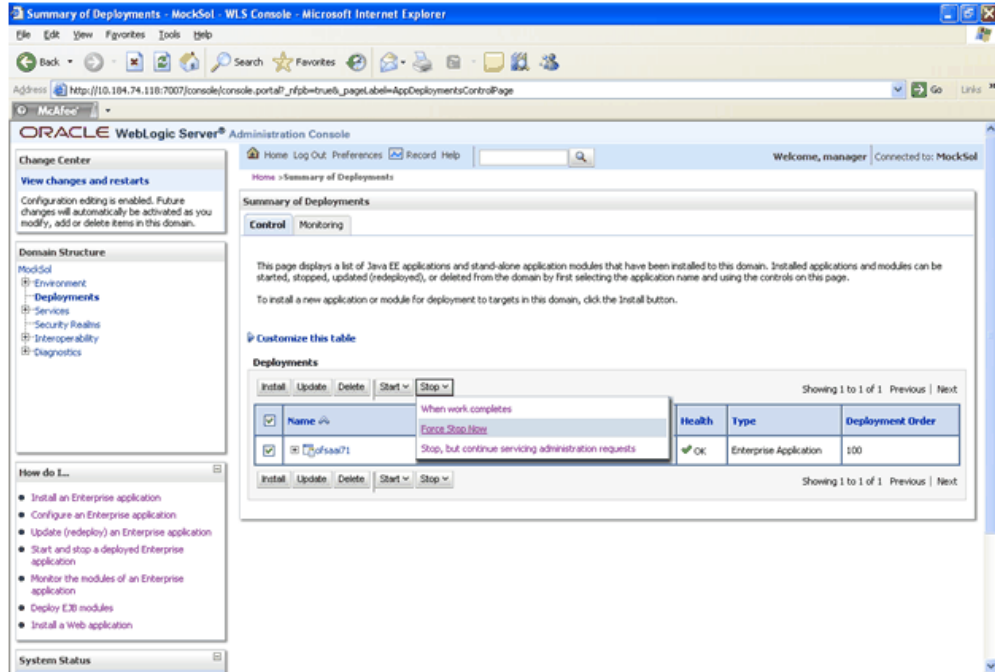

2. A confirmation message will be displayed asking to click **Yes** to stop the selected deployment. Click **Yes** to continue. A confirmation message will be displayed and the state of the deployment will change from Active to Prepared.

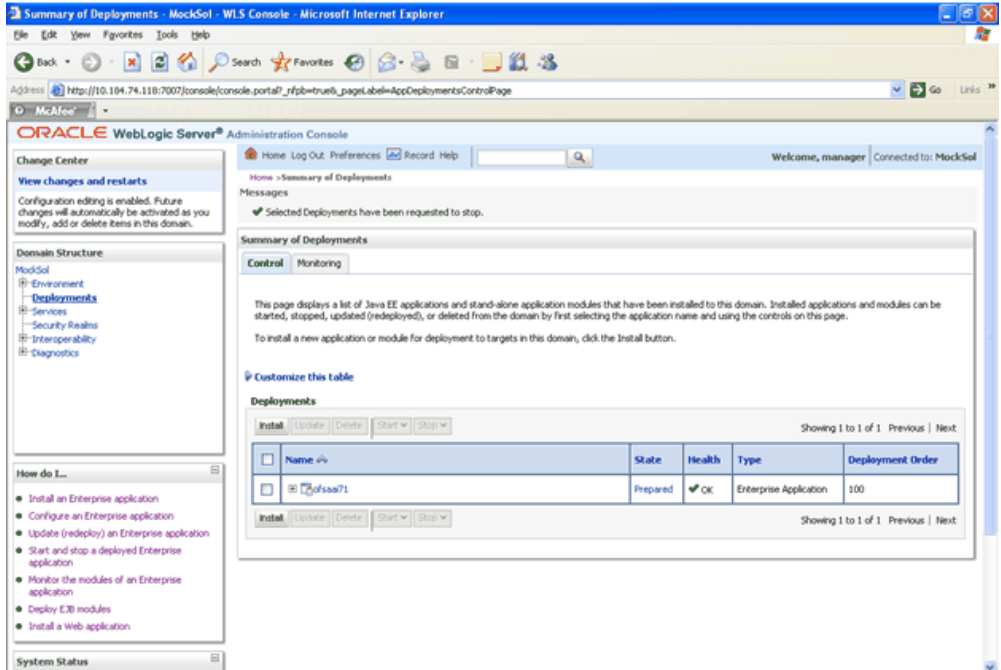

3. The **Delete** button will be enabled. Click Delete, to delete the selected Deployment.

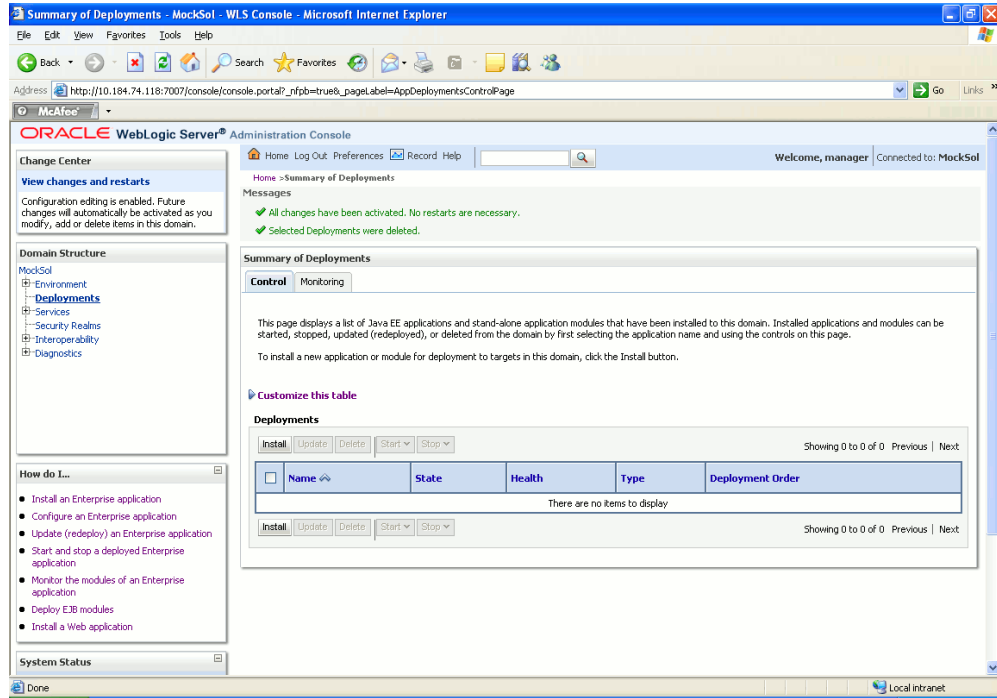

A message will be displayed to confirm the removal of the selected deployment from the domain configuration. Click **Yes** to continue.

The deployment will be deleted and a message will be displayed confirming the removal. A message will be displayed confirming that all the changes have been activated and no restart of the server is required.

Pre-Installation Applications Activities Checklist

Pre-Installation Applications Activities Checklist

Before any Financial Services Application Installation Kit programs are run, ensure that the pre-installation activities mentioned in the checklist below are all completed successfully. The Financial Services Application Installation Kits include the following applications:

- Oracle Financial Services Asset Liability Management
- Oracle Financial Services Profitability Management
- Oracle Financial Services Funds Transfer Pricing
- Oracle Financial Services Pricing Management, Transfer Pricing Component
- Oracle Financial Services Profitability Management Analytics
- Oracle Financial Services Asset Liability Management Analytics

The Tasks are as follows.

- Oracle Financial Services Analytical Applications Infrastructure must be successfully installed on a certified environment.
- Oracle Financial Services Profitability Management Analytics can be installed after installing Oracle Financial Services Profitability Management on the infodm.
- Oracle Financial Services Asset Liability Management Analytics can be installed after installing Oracle Financial Services Asset Liability on the infodm.
- It is implicit that all base software versions and patch levels required by the

operating system of Oracle Financial Services Analytical Applications Infrastructure v7.1 is available and adhered to.

- If Infrastructure installation is on multitier environment, Execute the following commands in the DB Layer terminal

```
chmod -R 777 < ftpshare folder >
```

Navigate to ftpshare folder and set the *umask* shown as below, this will make sure all the new files created will have 666 file permission.

```
cd < ftpshare folder >  
umask 0000
```

- The correct Financial Services Applications License Key should have been provided during installation of OFSAAI. This license key number is unique to the combination of Financial Services applications being installed. For example, the License Key if only installing Oracle Profitability Management is different than if installing Oracle Financial Services Profitability Management in conjunction with Oracle Financial Services Asset Liability Management. For information on updating your License Key once Infrastructure has already been installed, please contact Oracle Financial Services Support.
- The Config and Atomic schema should be two distinct oracle database users.
- The correct database privileges and tablespace quota should have been granted to the Config Schema user prior to OFSAAI installation. The correct database privileges and tablespace quota should have been granted to the Atomic Schema user prior to Information Domain (or Infodom) creation. For more information on Information Domain creation, see Configuring Details, page 14-1.
- All Infrastructure Configuration Steps should have been completed including:
 - Configuring the Database Server
 - Configuring the Application Server
 - Configuring the Web server
 - Configuring Database Details
 - Creating the Information Domain
- The Database Administrator should ensure that there is a TNS entry for the Database name provided. The Database name provided should be the name of the Atomic Schema. The TNS entry should be added to the `$ORACLE_HOME/network/admin/tnsnames.ora` file, located in the machine where the Oracle database server is installed.

- The Information Domain name is required during the application installation. A new Information Domain must be created pointing to the Atomic schema. Alternately, an existing Information Domain may also be used.
- There must be at least one segment mapped to this Information Domain. For more information on System Administration, Defining Segment Maintenance Details, see *Oracle Financial Services Analytical Applications Infrastructure User Guide*.
- An OFSAAI Administrator user must be created. This User ID will be required during application installation. For more information on Maintaining User Administrator Details, see *Oracle Financial Services Analytical Applications Infrastructure User Guide*. This Administrative user should be created after the above checklist items are complete using the following steps. The privileges documented below are the minimum required.
 1. Create a new Oracle Financial Services Analytical Applications Administrator user.
 2. Assign the new Oracle Financial Services Analytical Applications user to the User Groups 'ADMIN' and 'AUTH'.
 3. Map the new Oracle Financial Services Analytical Applications user's User Group to the Information Domain.
 4. Assign the following roles to the new OFSAAI user's User Group.
 - System Administrator
 - System Authorizer
 - ETL Analyst
 5. Authorize the new Oracle Financial Services Analytical Applications Administrator while logged in as 'sysauth'.
- Web Server Resource Reference Configuration must be complete. Refer to Resource Reference Configuration , page 15-1 for further information.

Check the \$FIC_WEB_HOME/webroot/WEB-INF/web.xml for the correct Resource tag. If not present add the tag to the end of the file and replace ORDEMO with the Infodomain name.

```
<resource-ref>
  <description>DB Connection ORDEMO</description>
  <res-ref-name>jdbc/ORDEMO</res-ref-name>
  <res-type>javax.sql.DataSource</res-type>
  <res-auth>Container</res-auth>
</resource-ref>
```

For example:

```

<resource-ref>
  <description>DB Connection OFSAAINFOD</description>
  <res-ref-name>jdbc/OFSAAINFOD</res-ref-name>
  <res-type>javax.sql.DataSource</res-type>
  <res-auth>Container</res-auth>
</resource-ref>

```

Additionally, if using Apache Tomcat, check the following two items:

1. Check that the \$CATALINA_HOME/lib/ojdbc6.jar file has been copied from the \$ORACLE_HOME/jdbc/lib.
2. Check the \$CATALINA_HOME/conf/server.xml for the correct data source tag.

The following should be included at the end of the file:

```

<Context path="/"<context name>" docBase="/"<Tomcat Installation
Directory>/webapps/<context name>" debug="0" reloadable="true"
crossContext="true">
  <Resource auth="Container"
    name="jdbc/<ORDEMO>"
    type="javax.sql.DataSource"
    driverClassName="oracle.jdbc.driver.OracleDriver"
    username="<Atomic Schema>"
    password="<Atomic Schema password>"
    url="jdbc:oracle:thin:@<DB engine IP address>:<DB Port>:<SID>"
    maxActive="100"
    maxIdle="30"
    maxWait="10000"/>
</Context>

```

For example:

```

<Context path="/ofsaa"
docBase="/OFSAA/tomcat/apache-tomcat-6.0.20/webapps/ofsaaom" debug="0"
reloadable="true" crossContext="true">
  <Resource auth="Container"
    name="jdbc/OFSAAINFOD"
    type="javax.sql.DataSource"
    driverClassName="oracle.jdbc.driver.OracleDriver"
    username="ofsaaatomic"
    password="ofsaaatomic"
    url="jdbc:oracle:thin:@10.123.18.22:1521:ofsaa"
    maxActive="100"
    maxIdle="30"
    maxWait="10000"/>
</Context>

```

- The Oracle Financial Services Funds Transfer Pricing / Asset Liability Management / Profitability Management Data Model must be successfully uploaded to the Information Domain.

Note: For more information on uploading the data model into the Information Domain, see *Oracle Financial Services Analytical Applications Infrastructure User Guide*.

For uploading the model, pick up the following XML file from installation folder.

- For Asset Liability Management installation, choose ALM_Datamodel.xml
- For Funds Transfer Pricing installation, choose FTP_Datamodel.xml
- For Profitability Management installation, choose PFT_Datamodel.xml

The Pricing Management, Transfer Pricing Component Data Model is a subset of the Funds Transfer Pricing Data Model. No model upload is required for this application. However, it must be installed into the same Information Domain as the Funds Transfer Pricing Application.

If installing multiple applications into the Infodomain, the data models for the applications must first be merged using CA Erwin. For assistance with merging data models, please contact Oracle Financial Services Support.

If any other solution is already installed in an Infodomain (atomic schema), then we need to perform Incremental Model Upload by merging the new model with already uploaded model.

- The Application Sources 'FSAPP_T2T' and 'FUSION_APPS' must be created, defined and models generated as documented in Appendix A: Defining Application Sources, page A-1.
- For the Application and Source creation of PFT BI AND ALM BI, perform the following steps.
 1. Create Applications –FUSION_APPS
 2. Create the following data source:
 3. RESULT_AREA_T2T - a RDBMS Source - pointing to the atomic database and date format should be set as mm/dd/yyyy.
 4. Map the Source RESULT_AREA_T2T to the application FUSION_APPS and generate source model
- All Oracle Financial Services Analytical Applications Infrastructure Servers must be shut down and Oracle 11g database must be running.

Have the following information available and handy before starting the Application Installation:

- Information Domain name
- The ftpshare path as configured in the Configuring Database Server Details
- TNS Name for the Atomic Schema
- OFSAAI Administrator user ID

Applications Installation

Introduction

The Oracle Financial Services Analytical Applications Infrastructure Product comprises of components that are installed in Web, Application & Database layer. Hence if you have installed Oracle Financial Services Analytical Applications Infrastructure in a multi-tier architecture, the Oracle Financial Services Applications installer must be invoked on each of the machines that host the Oracle Financial Services Analytical Applications Infrastructure tier. This chapter is applicable for the following products:

- Oracle Financial Services Asset Liability Management
- Oracle Financial Services Profitability Management
- Oracle Financial Services Funds Transfer Pricing
- Oracle Financial Services Pricing Management, Transfer Pricing Component

For a Single-tier installation, the installer is required to be invoked only once on the machine that hosts all the Oracle Financial Services Analytical Applications Infrastructure tiers.

This section describes the installation process where the Three Product setup components are installed on separate machines with the Product installation on separate machines. Machine A will be used to install Product Application Layer components, Machine B will be used to install Product Database Layer components and Machine C will be used to install Product Web Layer components

Note: This section holds applicable if Oracle Financial Services Analytical Applications Infrastructure is installed on separate machines A, B and C respectively.

Machine A – Product App Layer

Procedure

1. Copy the Setup.bin, Setup.sh and libcpptripdes.so from the installation CD on to a folder on the machine that hosts the Oracle Financial Services Analytical Applications Infrastructure application. To begin Oracle Financial Services Analytical Applications installation, execute Setup.sh.



2. Upon invoking the installer, the Introduction screen will display the pre-requisites for installation. Ensure that the pre-requisites are satisfied before you proceed.

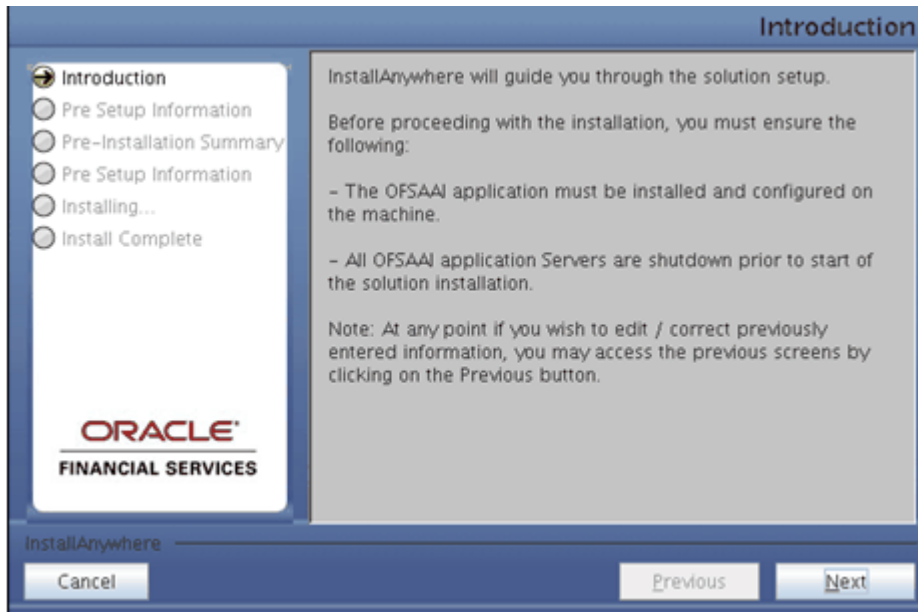

3. Choose the log mode for this installer. In case the Debug is selected, the Passwords will be printed in the Log File (\$FIC_HOME/SolutionsLog.log).

Note: SolutionsLOG.log name format will be Application Name_<INFODOM_NAME>_SolutionsLOG-<DATE>-<TIME>.log.

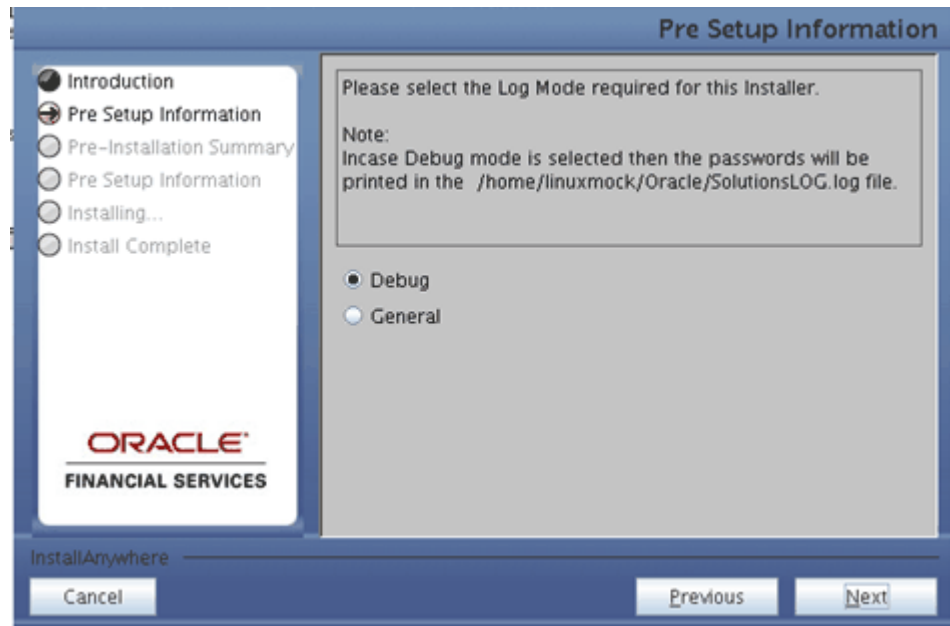

4. Provide 'EDELIVERY' in all caps when prompted for the 9 digit Customer Identification number.

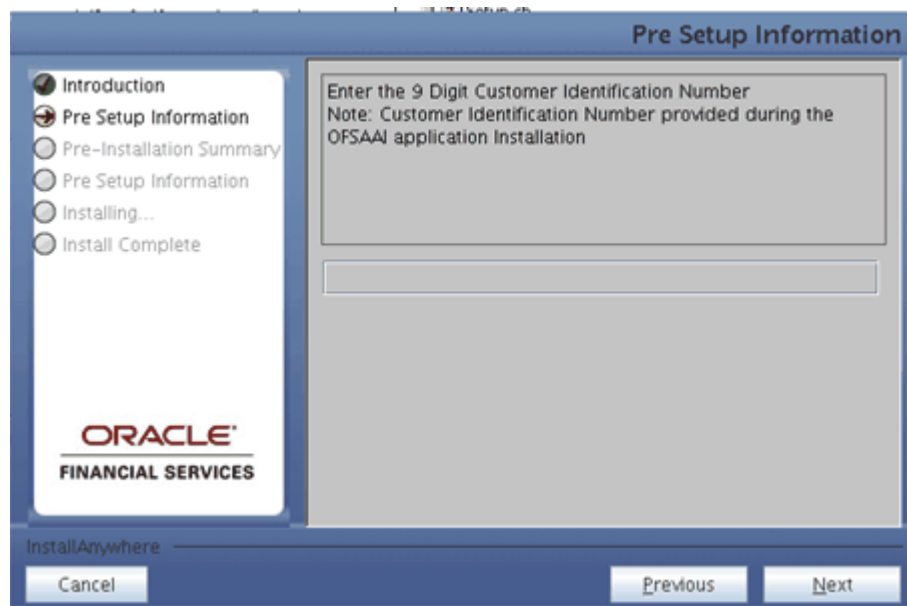

5. The Pre Setup Information screen requests for setup information.

Select the appropriate Oracle Financial Services Analytical Applications Infrastructure layer that has been installed on the machine.

Example

AppLayer

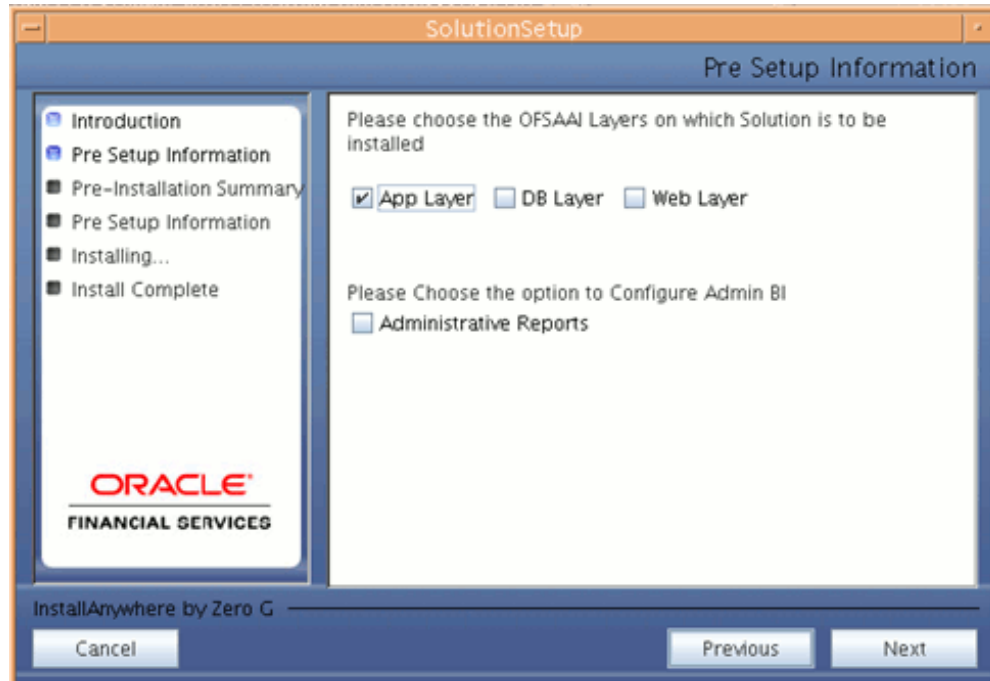

Along with appropriate Oracle Financial Services Analytical Applications Infrastructure layer choose Administrative Reports to configure the Administrative Reports application.

Note:

- For a single-tier Oracle Financial Services Analytical Applications Infrastructure 7.1 installation, you must select App Layer, DB Layer and Web layer. For a multi-tier Oracle Financial Services Analytical Applications Infrastructure 7.1 installation, select the corresponding layer installed on the machine.
- In the case of ALM BI and PFT BI solutions the above screen would look as shown below.



6. Enter the Information Domain in which the Oracle Financial Services Analytical Applications data model has been successfully uploaded and Segment name which is mapped with the infodom.

Enter the valid path that has been configured as the FTPshare Path in Oracle Financial Services Analytical Applications Infrastructure. You may click Choose to select the path. Click Restore Default to reset the path in case of erroneous entry.

Enter the TNS name for the Atomic schema (Same as what you've given in Database Master while creating the infodom)

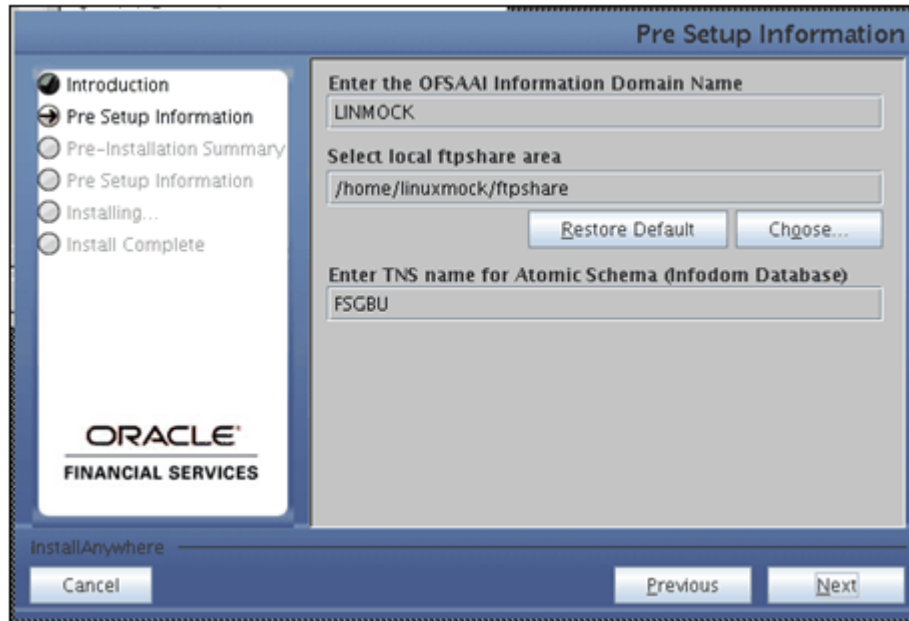

Click Next to continue.

7. The Pre Setup Information screen requests for the Oracle Financial Services Analytical Applications Infrastructure user ID.

Enter the Oracle Financial Services Analytical Applications Infrastructure user ID that has been mapped to the Information Domains provided earlier.



Click Next to continue.

8. The Pre-Installation Summary screen outlines the general information about the set up

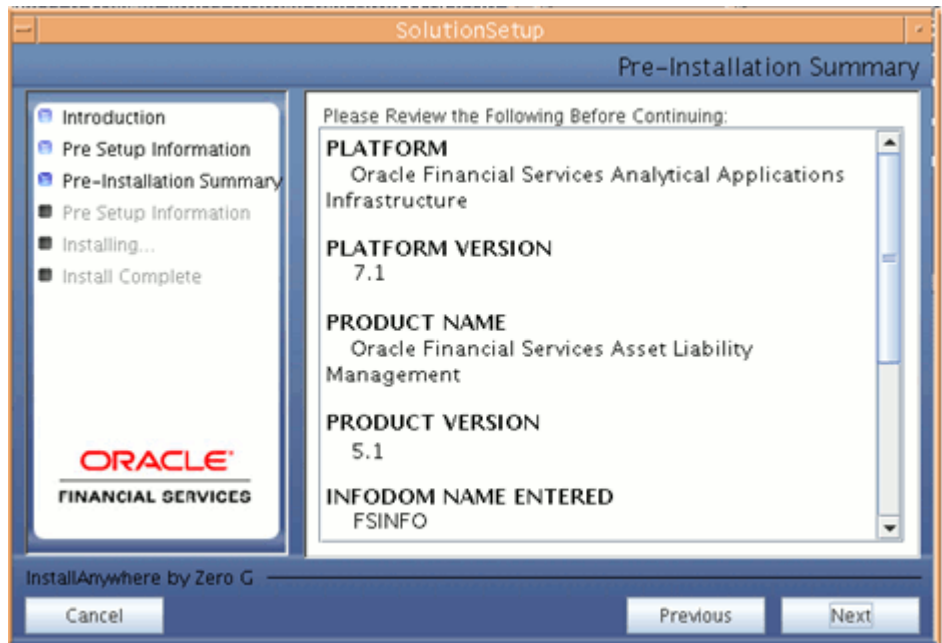

Pre Installation Summary screen will display the Oracle Financial Services Analytical Applications Infrastructure name, Oracle Financial Services Analytical

Applications Infrastructure Version, Product name, Product Version, Infodomain name, Segment name and so on. If you want to edit the input values like Infodomain name, Segment name you can do the same by clicking Back Otherwise

Click Next to continue

9. The following screen indicates the start of the installation. If you have entered the right information click Install to begin the installation process.

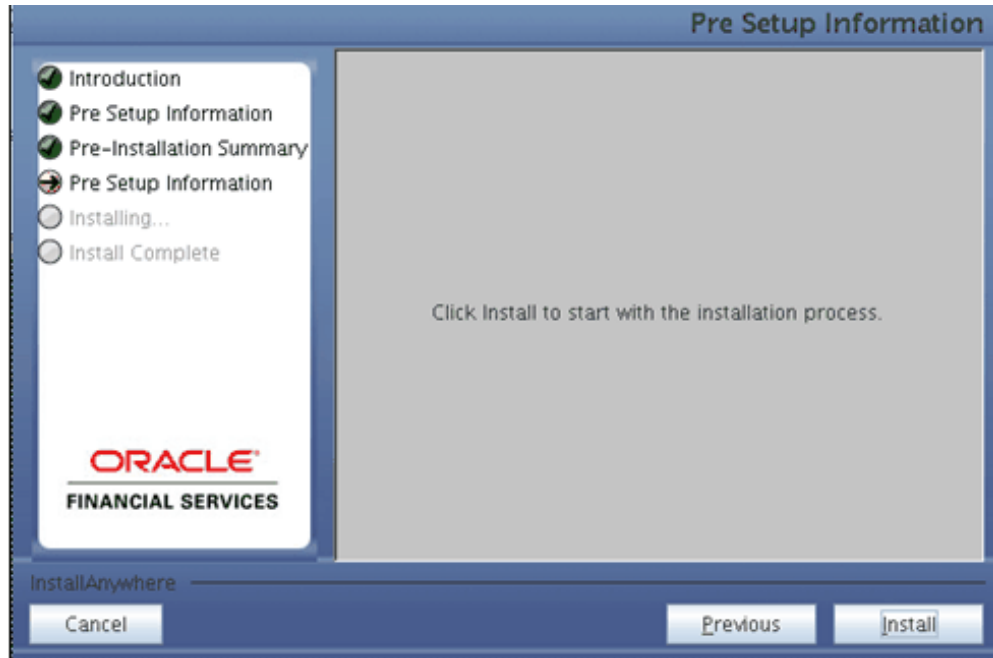

10. The following screen displays the progress of the installation. Upon completion of the process, the installation status is published on the screen.

You must access the file SolutionLOG.log in the path \$FIC_HOME to check for errors if any.

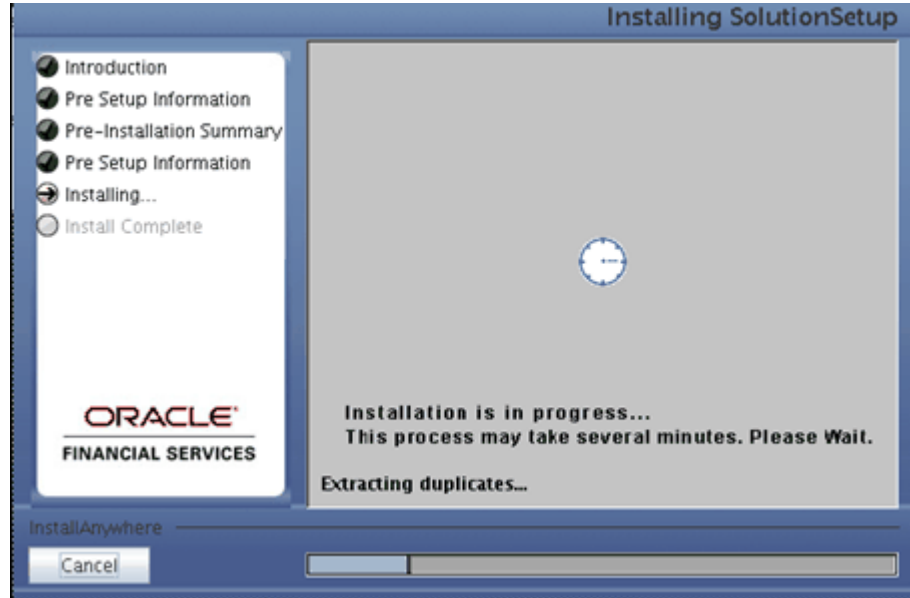

Note: • FIC_HOME is the environment variable set during the Oracle Financial Services Analytical Applications Infrastructure installation; it refers to the Installation directory.

11. The following screen displays the successful installation of the Oracle Financial Services Analytical Applications Setup.

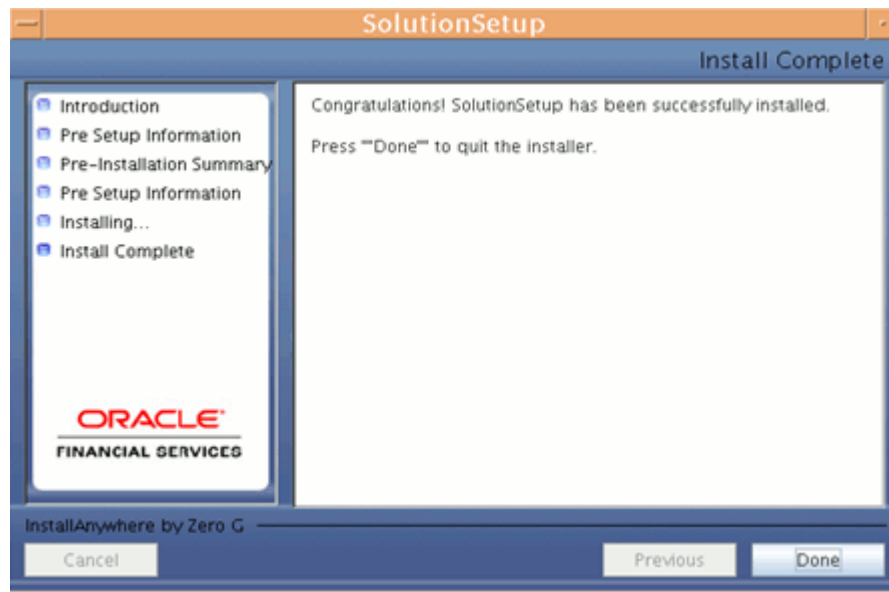

Click Done to quit the installer.

Machine B – Product Database Layer

Procedure

1. Copy the Setup.bin, Setup.sh and libcpptripides.so and from the installation CD on to a folder on the machine that hosts the Oracle Financial Services Analytical Applications Infrastructure application. To begin Oracle Financial Services Analytics Applications installation, execute Setup.sh

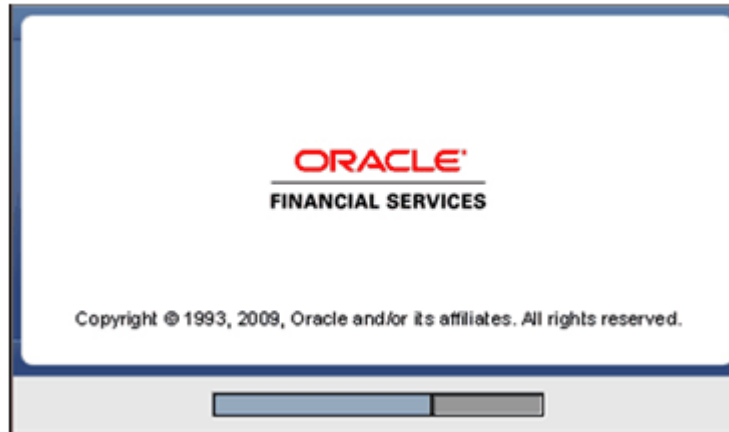

2. Upon invoking the installer, the Introduction screen will display the pre-requisites for installation. Ensure that the pre-requisites are satisfied before you proceed.

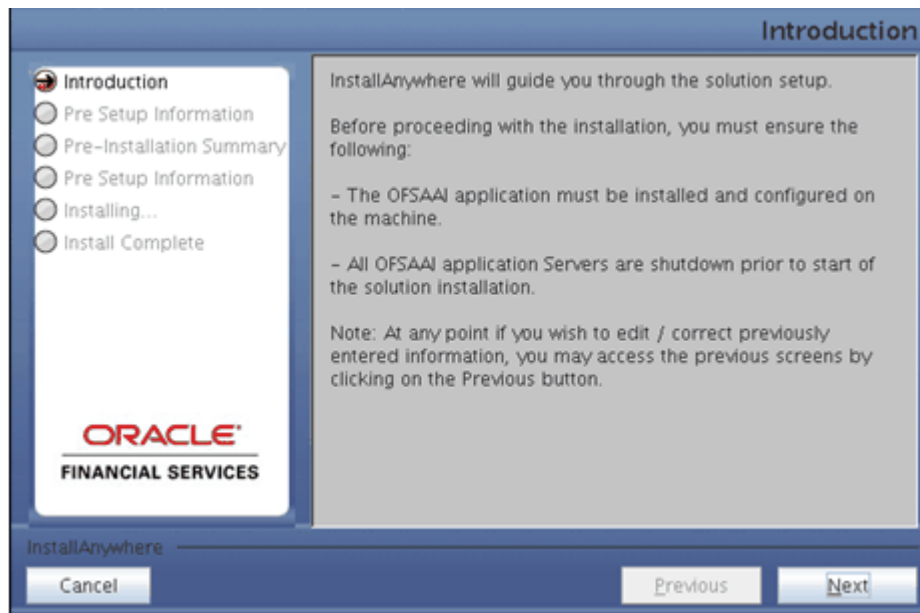

3. Choose the log mode for this installer. In case if the Debug is selected, the Passwords will be printed in the Log File (\$FIC_HOME/SolutionsLog.log).

Note: SolutionsLOG.log name format will be Application Name_<INFODOM_NAME>_SolutionsLOG-<DATE>-<TIME>.log.

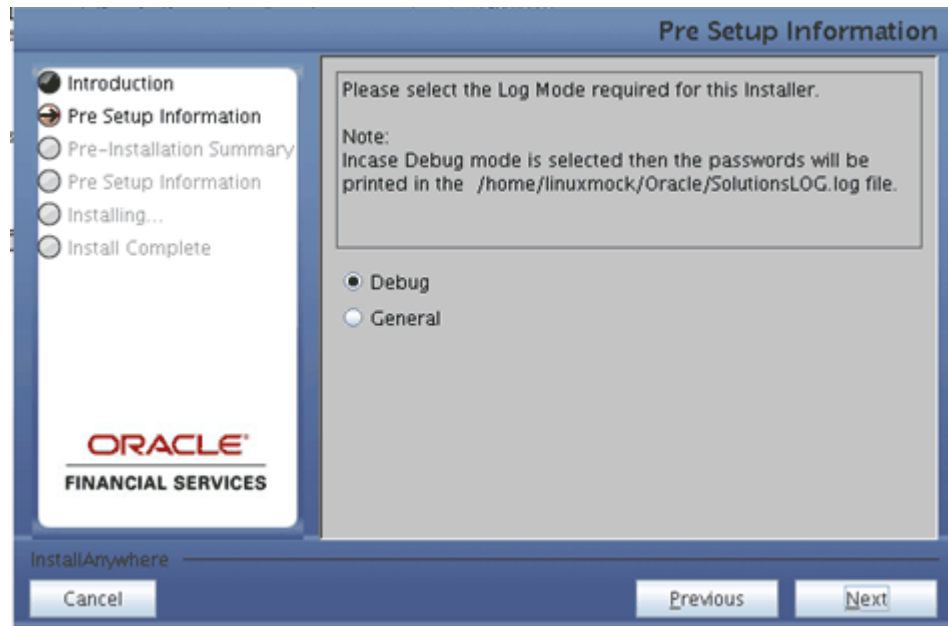

4. Provide 'EDELIVERY' in all caps when prompted for the 9 digit Customer Identification number.

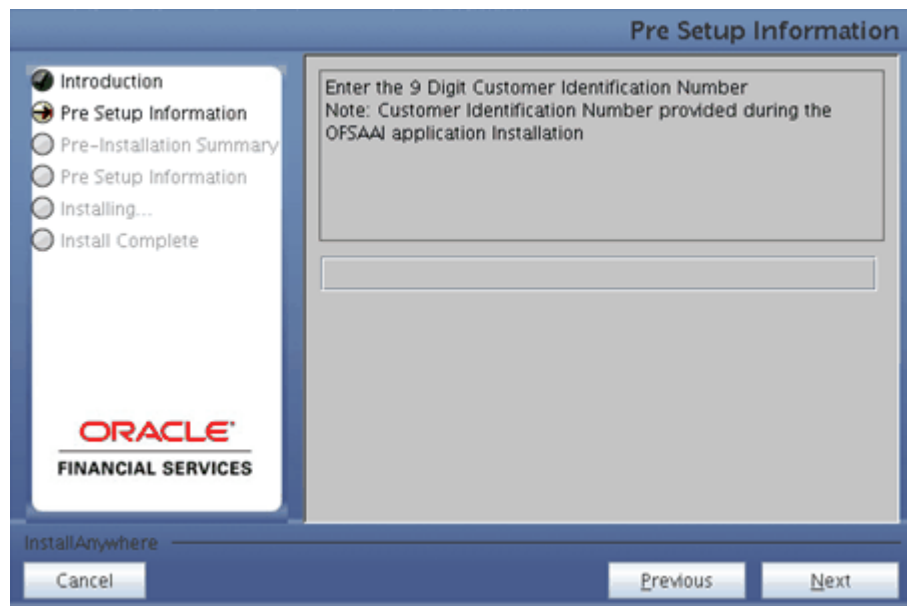

5. The Pre Setup Information screen requests for setup information.

Select the appropriate Oracle Financial Services Analytical Applications Infrastructure layer that has been installed on the machine.

Example

DB Layer



Along with appropriate Oracle Financial Services Analytical Applications Infrastructure layer choose Administrative Reports to configure the Administrative Reports application.

Note:

- For a single-tier Oracle Financial Services Analytical Applications Infrastructure 7.1 installation, you must select App Layer, Web Layer and DB Layer. For a multi-tier Oracle Financial Services Analytical Applications Infrastructure 7.1 installation, select the corresponding layer installed on the machine.
- In the case of ALM BI and PFT BI solutions the above screen would look as shown below.

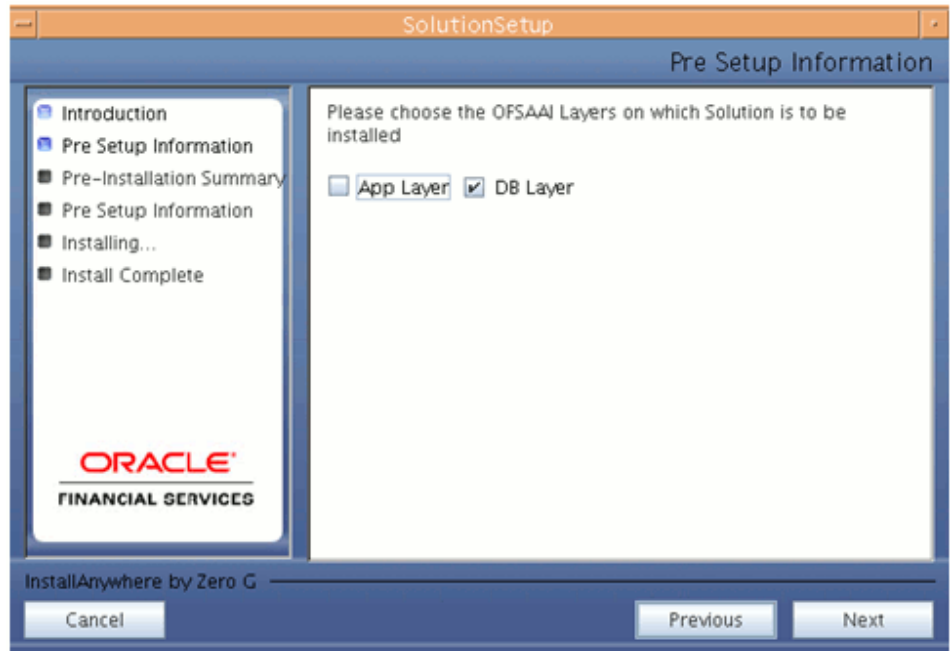

6. Enter the Information Domain in which the Oracle Financial Services Analytical Applications data model has been successfully uploaded.

Enter the valid path that has been configured as the FTPShare Path in Oracle Financial Services Analytical Applications Infrastructure. You may click Choose to select the path. Click Restore Default to reset the path in case of erroneous entry.

Enter the Config schema user ID. Also enter the Config schema db driver details and the connection URL. (DB driver and the connection urn can be taken from the Dynamic services.xml in the \$FIC_HOME/conf folder of the app layer.

Enter the TNS name for the Atomic schema as mentioned in Database master while creating the infodom.

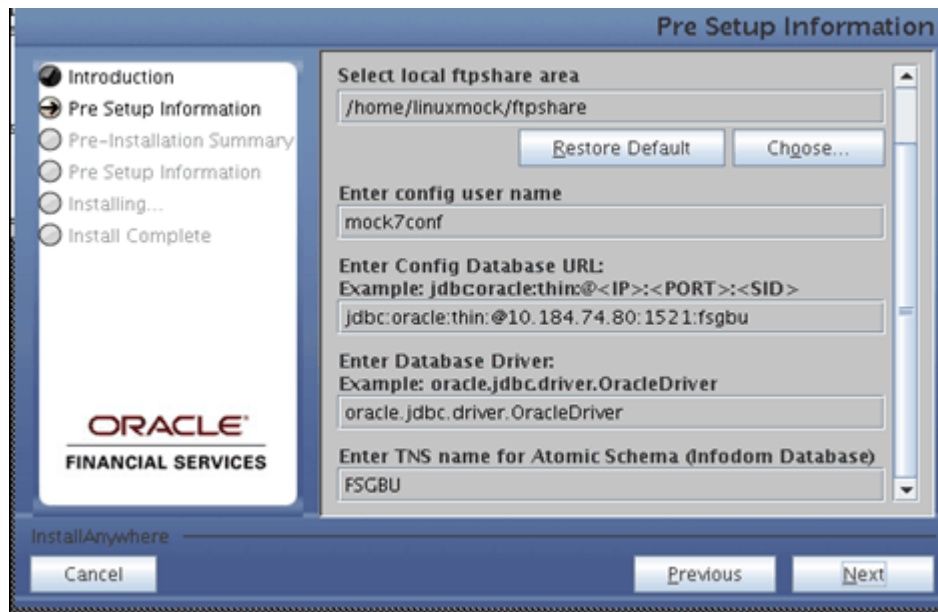
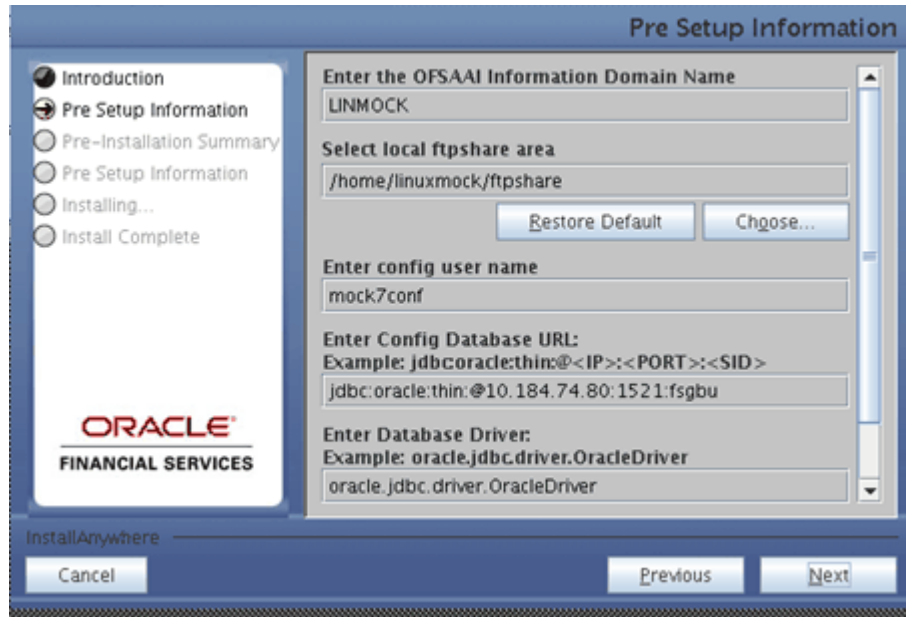

7. The Pre Setup Information screen requests for the Oracle Financial Services Analytical Applications Infrastructure user ID.

Enter the Oracle Financial Services Analytical Applications Infrastructure user ID that has been mapped to the Information Domains provided earlier.

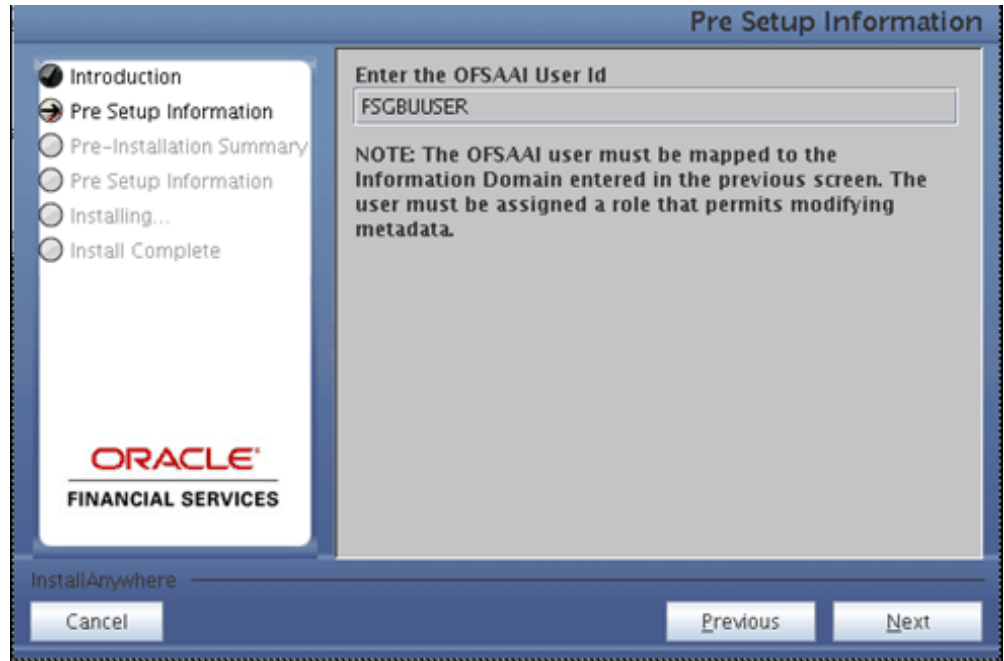

Click Next to continue.

8. The Pre-Installation Summary screen outlines the general information about the set up

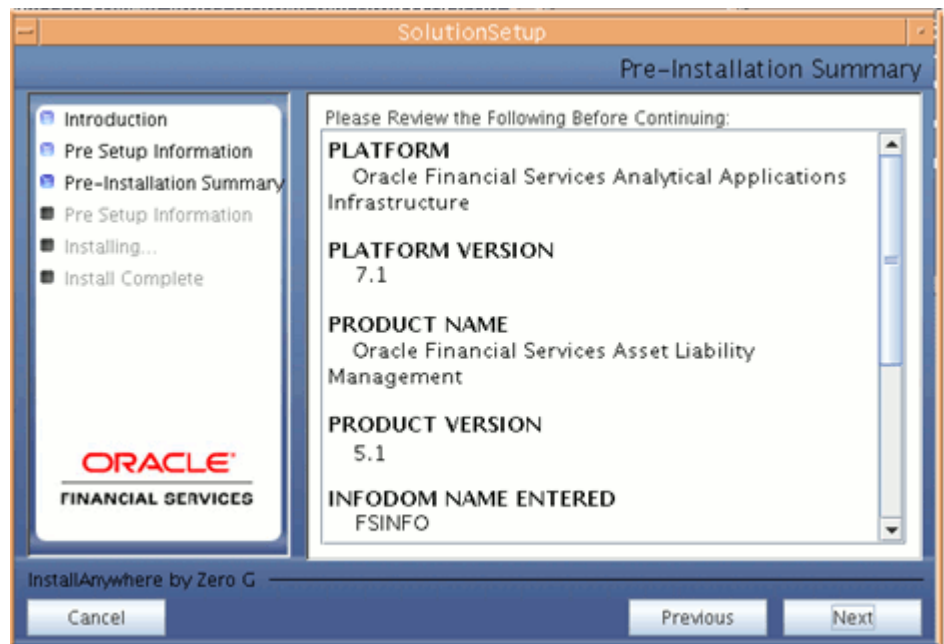

Pre Installation Summary screen will display the Oracle Financial Services Analytical Applications Infrastructure name, Oracle Financial Services Analytical

Applications Infrastructure Version, Product name, Product Version, Infodomain name, Segment name and so on. If you want to edit the input values like Infodomain name, Segment name you can do the same by clicking Back Otherwise

Click Next to continue.

9. The following screen cautions before starting the installation. If you have entered the right information click Install to begin the installation process.

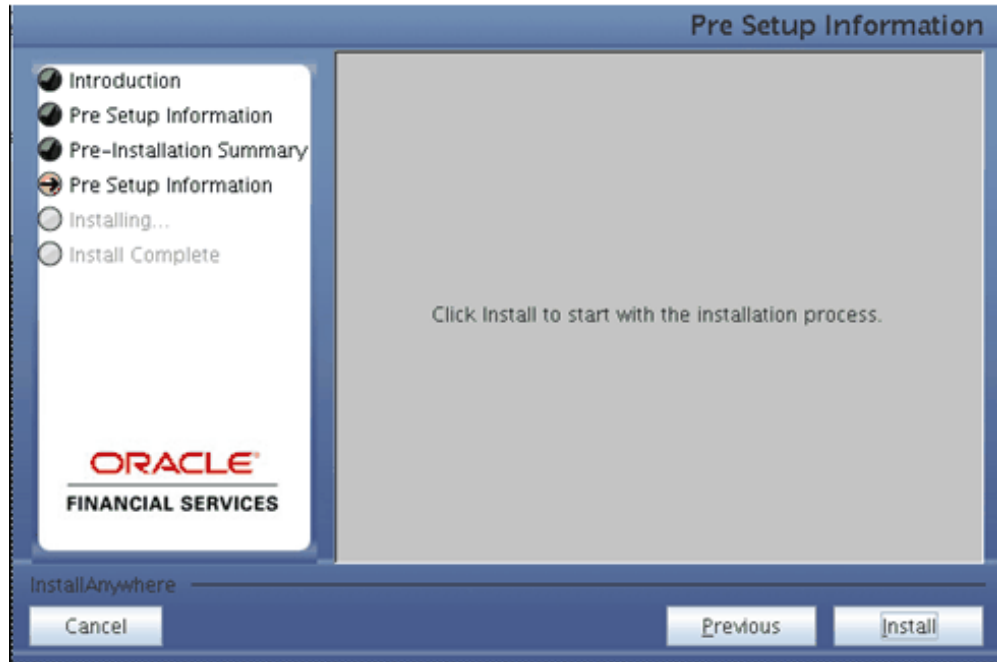

10. The following screen displays the progress of the installation. Upon completion of the process, the installation status is published on the screen.

You must access the file SolutionLOG.log in the path \$FIC_HOME to check for errors if any.

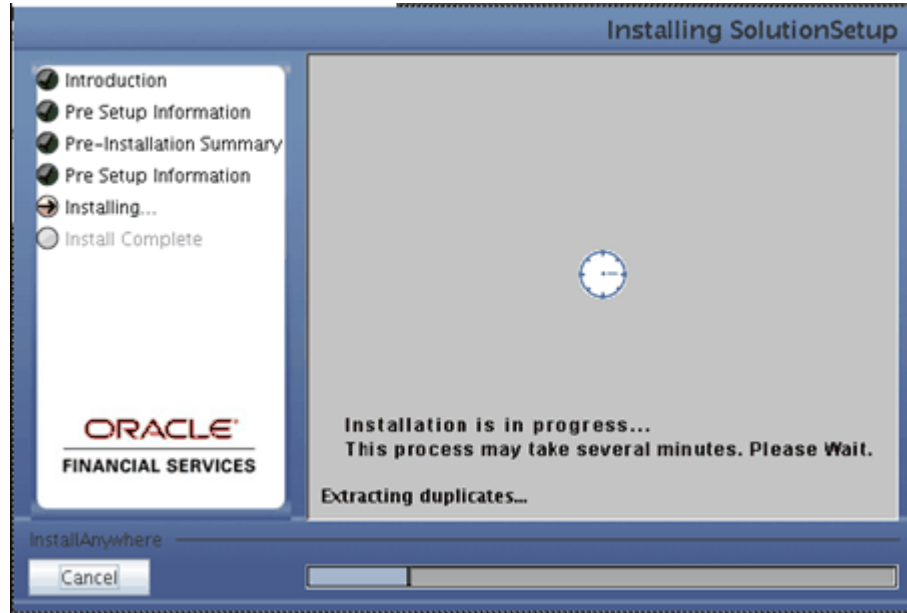

Note: FIC_HOME is the environment variable set during the Oracle Financial Services Analytical Applications Infrastructure installation; it refers to the Installation directory.

11. The following screen displays the completion of installation of the Oracle Financial Services Analytical Applications Setup.

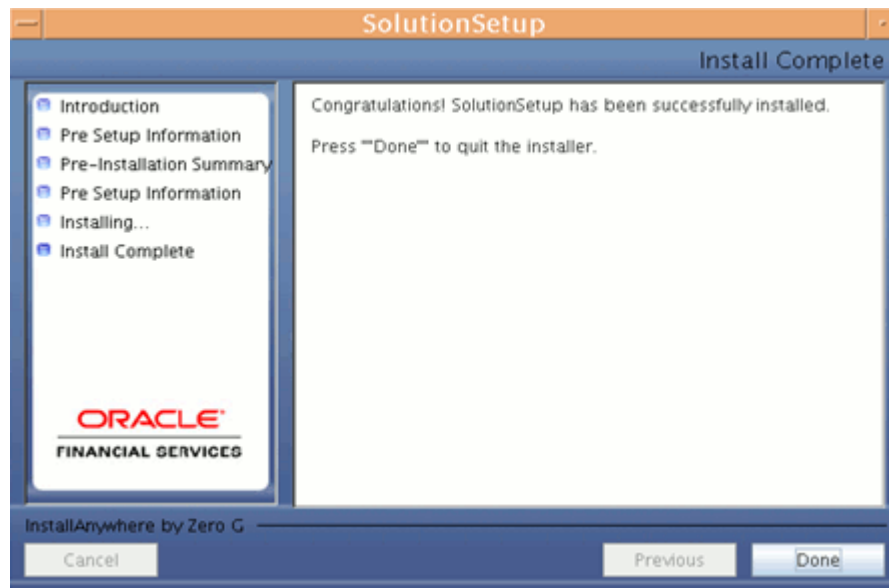

Click Done to quit the installer.

Machine C – Product Web Layer

Procedure

1. Copy the Setup.bin, Setup.sh and libcpptrip1des.so from the installation CD on to a folder on the machine that hosts the Oracle Financial Services Analytical Applications Infrastructure application. To begin Oracle Financial Services Analytical Applications installation, execute Setup.sh.



2. Upon invoking the installer, the Introduction screen will display the pre-requisites for installation. Ensure that the pre-requisites are satisfied before you proceed.

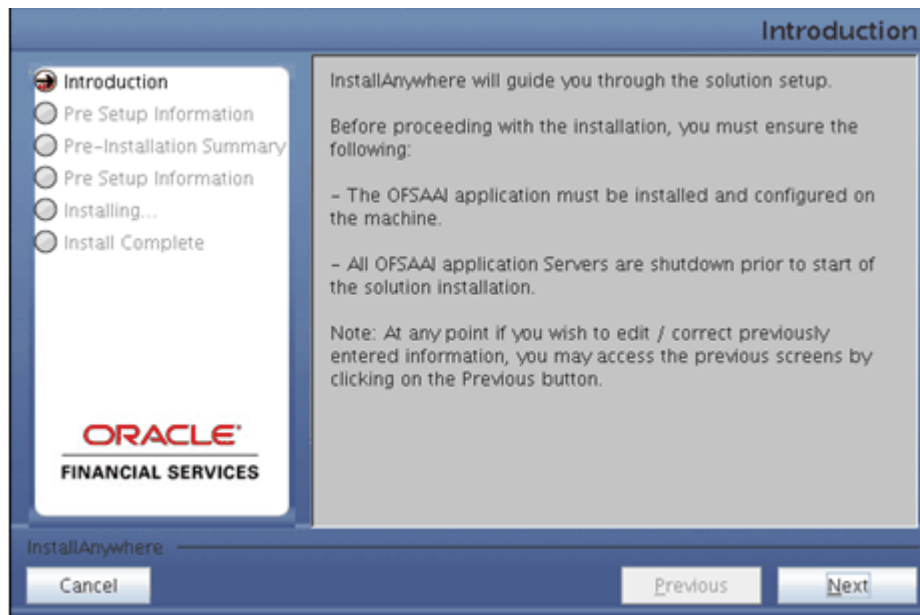

Click Next to continue.

- At any point during the installation process, if you Click Cancel, the installation process will be aborted and you will exit this setup.
 - At any point during the installation process, if you Click Previous, you will return to the previous screen.
3. Choose the log mode for this installer. In case if the Debug is selected, the Passwords will be printed in the Log File (\$FIC_HOME/SolutionsLog.log).

Note: SolutionsLOG.log name format will be Application Name_<INFODOM_NAME>_SolutionsLOG-<DATE>-<TIME>.log

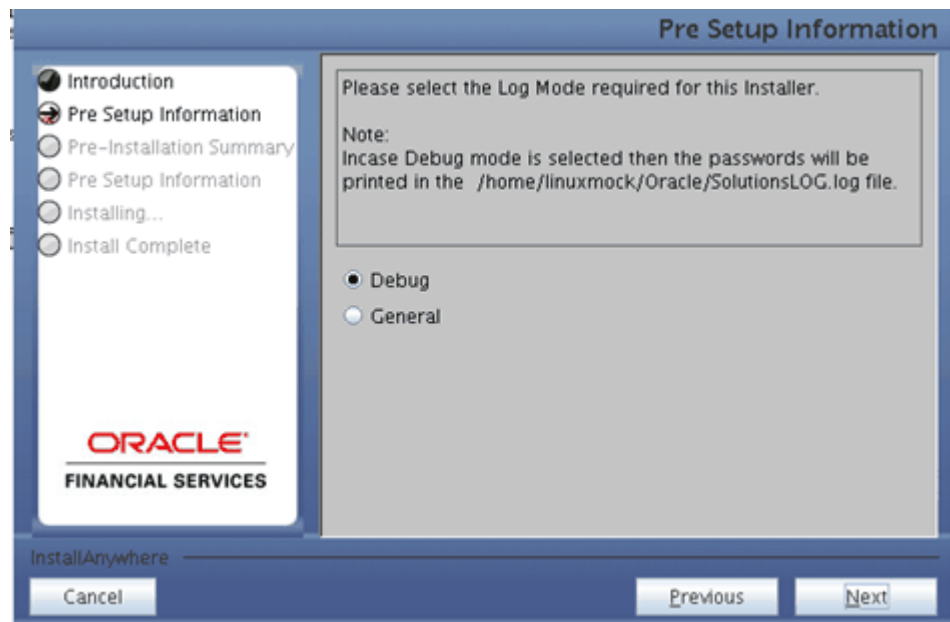

4. Provide 'EDELIVERY' in all caps when prompted for the 9 digit Customer Identification number.

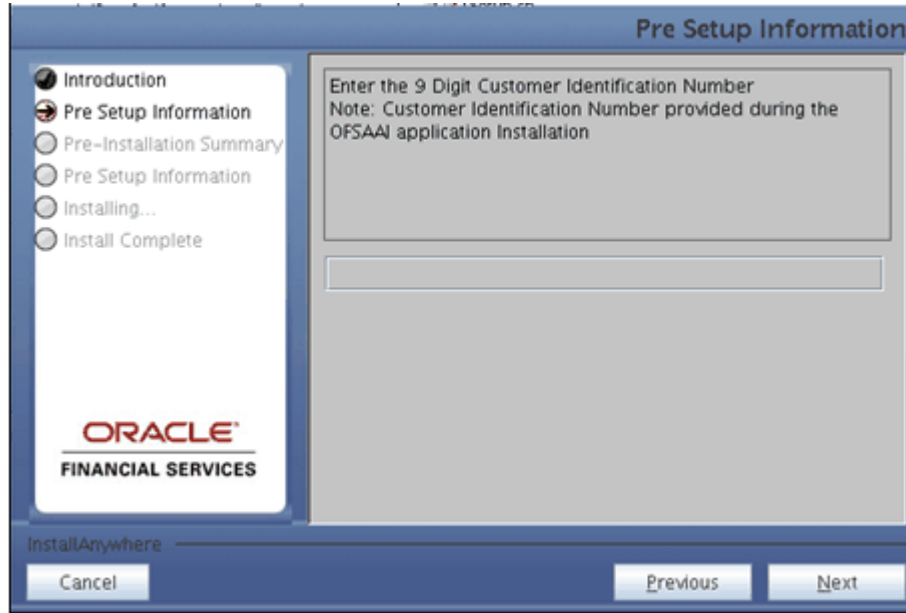

5. The Pre Setup Information screen requests for setup information.

Select the appropriate Oracle Financial Services Analytical Applications Infrastructure layer that has been installed on the machine.

Example

Web Layer

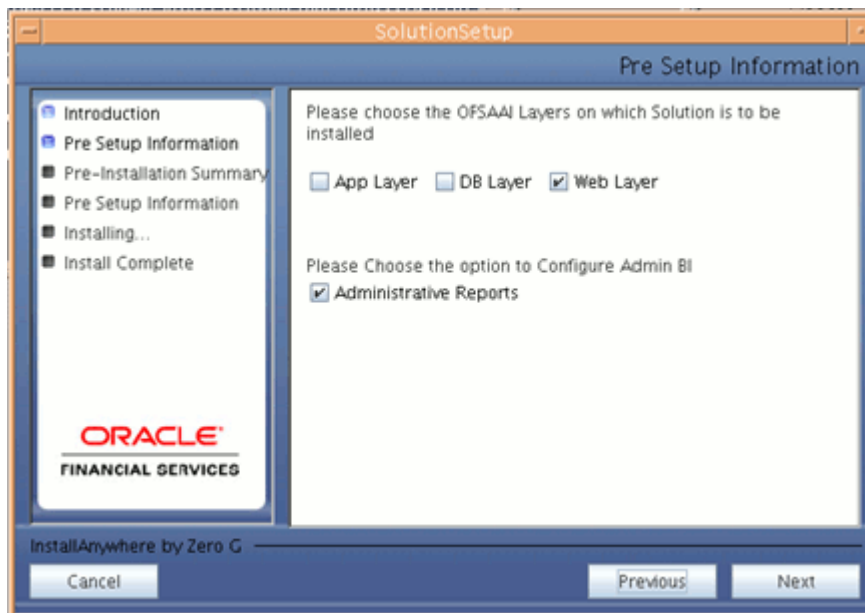

Along with appropriate Oracle Financial Services Analytical Applications

Infrastructure layer choose Administrative Reports to configure the Administrative Reports application.

Note: For a single-tier Oracle Financial Services Analytical Applications Infrastructure installation, you must select App Layer, Web Layer and DB Layer. For a multi-tier Oracle Financial Services Analytical Applications Infrastructure installation, select the corresponding layer installed on the machine.

6. Enter the Information Domain in which the Oracle Financial Services Analytical Applications data model has been successfully uploaded.

Enter the valid path that has been configured as the FTPShare Path in Oracle Financial Services Analytical Applications Infrastructure. You may click Choose to select the path. Click Restore Default to reset the path in case of erroneous entry. Enter the Config schema user ID and the password.

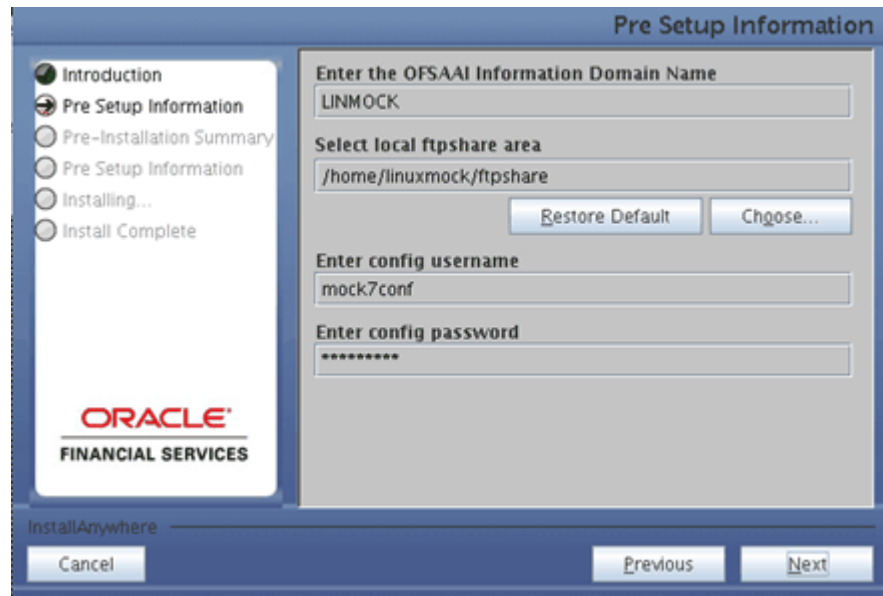

Click Next to continue.

7. The Pre Setup Information screen requests for the Oracle Financial Services Analytical Applications Infrastructure user ID.

Enter the Oracle Financial Services Analytical Applications Infrastructure user ID that has been mapped to the Information Domain provided earlier. Enter the TNS name for the Atomic schema (Same as what you give in Database Master while you create the infodom)

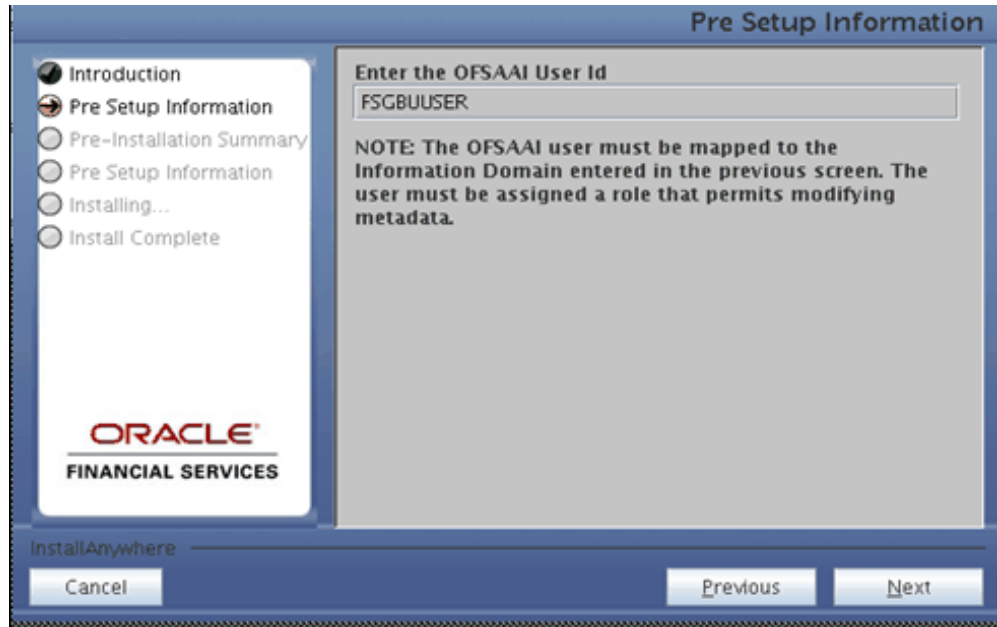

8. The Pre-Installation Summary screen outlines the general information about the set up



Pre Installation Summary screen will display the Oracle Financial Services Analytical Applications Infrastructure name, Oracle Financial Services Analytical Applications Infrastructure Version, Product name, Product Version, Infodom name, Segment name and so on. If you want to edit the input values like Infodom

name, Segment name you can do the same by clicking Back Otherwise Click Next to continue.

9. The following screen indicates the start of the installation.
If you have entered the right information click Install to begin the installation process.

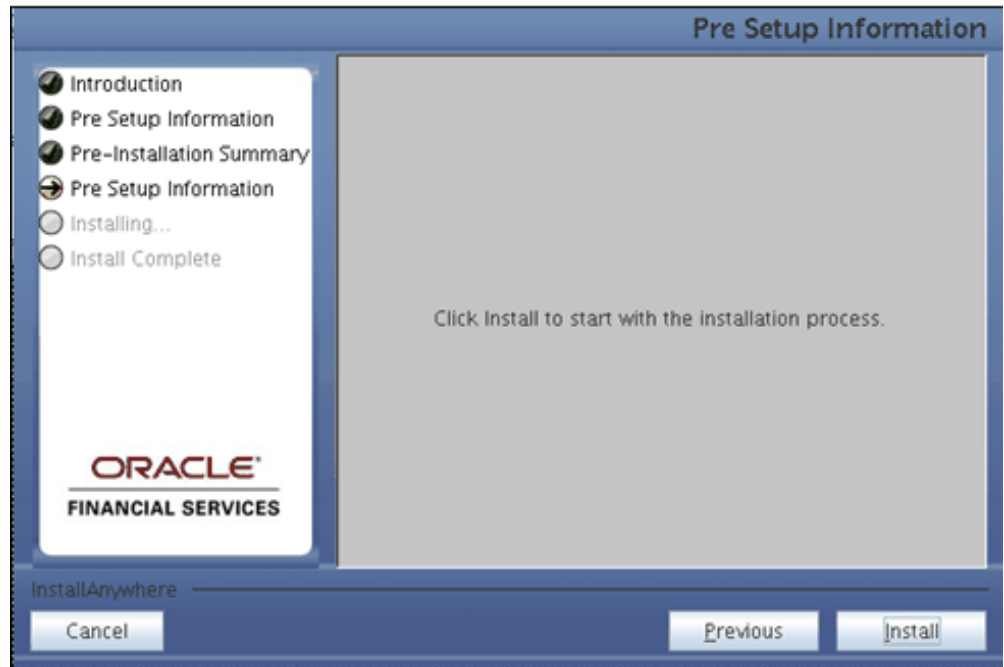

10. The following screen displays the progress of the installation. Upon completion of the process, the installation status is published on the screen. You must access the file SolutionLOG.log in the path \$FIC_HOME to check for errors if any.

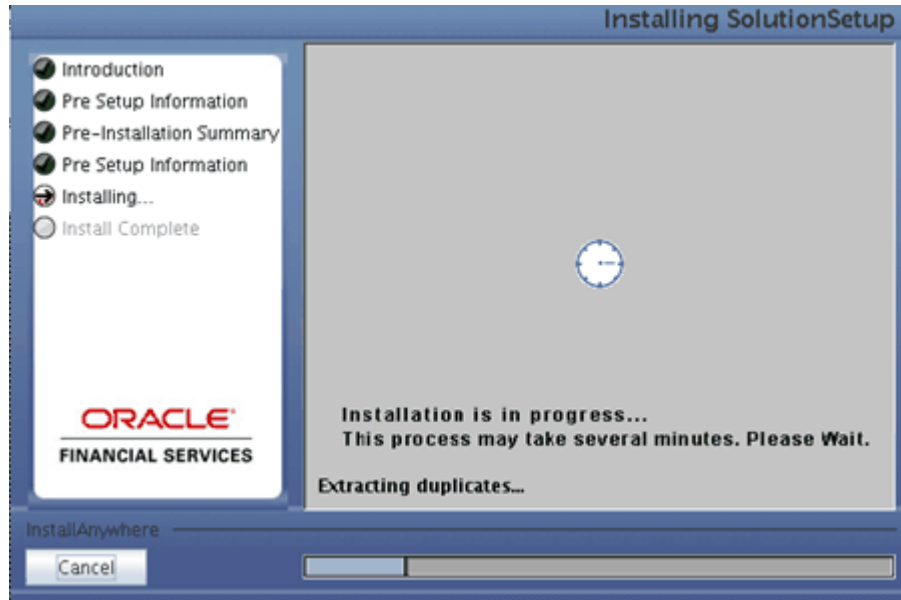

Note: FIC_HOME is the environment variable set during the Oracle Financial Services Analytical Applications Infrastructure installation; it refers to the Installation directory.

11. The following screen displays the successful installation of the Oracle Financial Services Analytical Applications Setup.

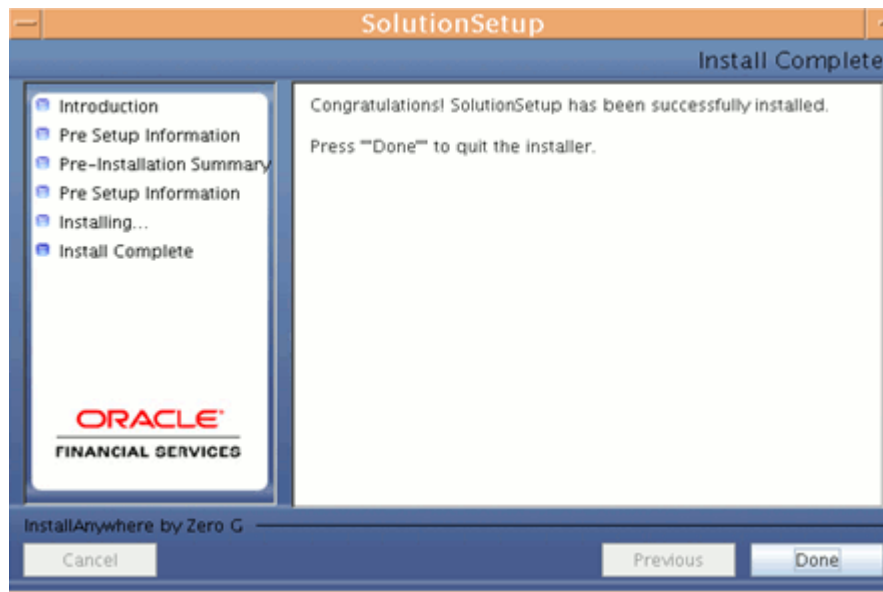

Click Done to quit the installer.

Post Application Installation Activities

Post Application Installation Checklist

Once the installation of Oracle Financial Services FTP, PFT and ALM Product is completed, you must perform the following steps.

√

Tasks

In the case of FTP and ALM check the Log files SolutionsLOG.log, SolutionSetup_InstallLog.log under \$FIC_HOME.

Note: SolutionsLOG.log name format will be Application Name_<INFODOM_NAME>_SolutionsLOG-<DATE>-<TIME>.log

Ignore the Unique key/ primary key violated constraints.

For OBI configuration follow the steps mentioned in Readme_OFSPA5.1_PostInstall_Steps.txt under app layer's \$FIC_HOME/Application Name

If installing Profitability Management, confirm the following tag has been added by the Application Installation to the \$FIC_HOME/ficweb/webroot/WEB-INF/web.xml file:

```
<!-- PFT xml file path retrieval-->
  <servlet>
    <servlet-name>pftxmlfilepath</servlet-name>

    <servlet-class>com.ofs.fsapps.pft.util.ContextxmlPathLoader</servlet-class>
    <load-on-startup>1</load-on-startup>
  </servlet>
<!--End of PFT xml file path retrieval-->
```

The above is only required for Profitability Management. Similar entries are not required for Asset Liability Management or Funds Transfer Pricing.

Re-create and re-deploy the WAR file (context name.war>file).

Refer to WebSphere EAR Files Creation and WebSphere EAR Files Deployment in the Oracle Financial Services Analytical Applications Infrastructure Installation Manual

.profile should be executed before starting any activity from the console.

Note: In case of Multitier Installation

Readme_OFSPA v5.1_PostInstall_Steps.txt will be available under \$FIC_HOME/adminbi folder of App Layer installation.

Start all Oracle Financial Services Analytical Applications Infrastructure Servers.

Start the Web Server (that is: Tomcat or websphere)

Refer Starting Oracle Financial Services Analytical Applications Infrastructure Servers in the Oracle Financial Services Analytical Applications Infrastructure Installation Manual for assistance in starting the servers.

Recompile any invalid Functions, procedures and views.

Assign the appropriate administrator application role to the Oracle Financial Services Analytical Applications Administrator user:

ALM Admin

FTP Admin

PFT Admin

TPOL Admin

Login as the new user and define global and application preference settings.

Batch with "Batch_Table_Class_Req" task needs to be created and executed [for any Information date]. This step will ensure the object-registrations are validated and made available to the individual applications. Once the batch is setup, every time a data model is uploaded or a new dimension is registered, this batch needs to be executed.

Steps to create and execute a batch for Batch_Table_Class_Req task:

1. Navigate to Operations then Batch Scheduling.
2. Define a New Batch.
3. Use the following for the new Batch Definition:
Define a New Batch.
Select an Empty Batch and Name the Batch.
Component ID: Transform Data
Description: Object Registration
Click on Parameter
Datastore Type: EDW
Datastore Name: <select from list of value>
IP Address: <select from list of values>
Rule Name: Batch_Table_Class_Req
Parameter List: Null
4. Execute the new Batch.
5. Navigate to Batch Monitoring to verify the Batch run was successful.

The Oracle Financial Services Funds Transfer Pricing, Profitability Management, Asset Liability Management/ Profitability Management/ Funds Transfer Pricing Product is now ready to be used.

Oracle Financial Services Analytical Applications Infrastructure v7.1 OFSPA Look-up Table Configuration

- Erwin model to be extended with the required lookup tables.
- Columns to be registered as processing keys/balance ranges.

- Post the model change a incremental model upload should be done for the application to reflect the changes.

If you encounter any problems during setup, kindly contact Oracle Financial Services Support.

OBIEE Installation and Configuration Guide Link

Note: Refer the following link to down load the OBIEE installation and configuration guide document.

http://www.oracle.com/technology/documentation/bi_ee.html

Annexure

Third Party Freeware

This product includes software developed by the Apache Software Foundation (<http://www.apache.org>).

The Apache Software License, Version 1.6.5

Copyright (C) 2006 The Apache Software Foundation. All rights reserved.

1. Redistribution and use in source and binary forms, with or without modification, are permitted provided that the following conditions are met:
2. Redistributions of source code must retain the above copyright notice, this list of conditions and the following disclaimer.
3. Redistributions in binary form must reproduce the above copyright notice, this list of conditions and the following disclaimer in the documentation and / or other materials provided with the distribution.
4. The end-user documentation included with the redistribution, if any, must include the following acknowledgment: "This product includes software developed by the Apache Software Foundation (<http://www.apache.org>)."
Alternately, this acknowledgment may appear in the software itself, if and wherever such third-party acknowledgments normally appear.
5. The names "log4j" and "Apache Software Foundation" must not be used to endorse or promote products derived from this software without prior written permission. For written permission, contact apache@apache.org.

6. Products derived from this software may not be called "Apache", nor may "Apache" appear in their name, without prior written permission of the Apache Software Foundation.

THIS SOFTWARE IS PROVIDED ``AS IS" AND ANY EXPRESSED OR IMPLIED WARRANTIES, INCLUDING, BUT NOT LIMITED TO, THE IMPLIED WARRANTIES OF MERCHANTABILITY AND FITNESS FOR A PARTICULAR PURPOSE ARE DISCLAIMED. IN NO EVENT SHALL THE APACHE SOFTWARE FOUNDATION OR ITS CONTRIBUTORS BE LIABLE FOR ANY DIRECT, INDIRECT, INCIDENTAL, SPECIAL, EXEMPLARY, OR CONSEQUENTIAL DAMAGES (INCLUDING, BUT NOT LIMITED TO, PROCUREMENT OF SUBSTITUTE GOODS OR SERVICES; LOSS OF USE, DATA, OR PROFITS; OR BUSINESS INTERRUPTION) HOWEVER CAUSED AND ON ANY THEORY OF LIABILITY, WHETHER IN CONTRACT, STRICT LIABILITY, OR TORT (INCLUDING NEGLIGENCE OR OTHERWISE) ARISING IN ANY WAY OUT OF THE USE OF THIS SOFTWARE, EVEN IF ADVISED OF THE POSSIBILITY OF SUCH DAMAGE.

This software consists of voluntary contributions made by many individuals on behalf of the Apache Software Foundation. For more information on the Apache Software Foundation, see <<http://www.apache.org>>

NAG Limited

NAG Limited © 2005

Portions utilize NAG's C library - All rights reserved

Configuration of OFSAAI

Configuration for Model Upload Utility

The Model Upload Utility uploads the Data Model through the command line parameter by executing a shell script file. It is used to upload Models that are huge in size. The ERwin file that contains the Data Model information must be placed at the following location.

```
<ftpshare>/<infodom>/erwin/erwinXML
```

File required to run Model Upload Utility

Upload.sh - This is a shell script to run the utility. Upload.sh is present at the following location.

```
$FIC_HOME/ficapp/common/FICServer/bin
```

Running the Model Upload Utility

Procedure

1. Open Upload.sh and enter the following arguments in the file
 1. <infodom> - Refers to the DSN name.
 2. <entire file path> – Refers to the Erwin File Path
 3. <username>
 4. <uploadmode N/R/AM> - Refers to the Upload Choice Code
 - N - Refers to the New Model Upload
 - AM - Refers to the Incremental Model Upload

- R - Refers to the Complete Model Rebuild Upload
5. <runscriptsFlag> - Refers to the running of SQL Script
 - <true>- Updates the database/schema with the Model changes
 - <false>- Does not update the database/schema with Model changes
2. Execute the script using the command ./upload.sh

Note: You should be having the execute permission to do execute the same.
 3. Logs are updated in regular Model Upload log in the following location
 ftpshare/<infodomain>/logs/<infodomain>_LOG_<last data model version>_<MM.DD.YYYY>-<HH.MM.SS>.log

Model Upload Details

The following table shows the Java settings details which needs to configured while uploading the data model with various size of xml's by

- Picking file from the server option
- Model Upload Utility
- Browsing the file in the local computer

Note: The below table consists of the Java settings done on both client and server machines. These Java settings will differ depending on the availability of RAM.

SIZE OF XML FILE	TRANSFORMING TIME	TOTAL MODEL UPLOAD TIME	JAVA SETTINGS IN THE SERVER	JAVA SETTINGS IN CLIENT
------------------	-------------------	-------------------------	-----------------------------	-------------------------

PICK	50MB	10 min	14 min	200M to 400M	
FILE	90MB	26 min	30 min	200M to 800M	
FROM	156MB	30 min	34 min	200M to 1000M	
THE	185MB	31 min	36 min	200M to 1200M	
SERVER	215MB	33 min	40 min	200M to 1200M	
OPTION					
THROU	50MB	10 min	14 min	200M to 400M	
GH	90MB	26 min	30 min	200M to 800M	
UTILITY	156MB	30 min	34 min	200M to 1000M	
	185MB	31 min	36 min	200M to 1200M	
	215MB	33 min	40 min	200M to 1200M	
BROWSI	50MB	10 min	14 min	200M to 400M	200M to
NG FILE	90MB	26 min	30 min	200M to 800M	XMx350M
	156MB	30 min	34 min	200M to 1000M	200M to
	185MB	31 min	36 min	200M to 1200M	XMx400M
	215MB	33 min	40 min	200M to 1200M	200M to
					XMx600M
					200M to
					XMx600M
					200M to
					XMx800M

Steps to Change the Java Setting on Server:

1. Edit the \$FIC_HOME/ficapp/common/FICServer/bin/reveleusstartup.sh script X_ARGS prior to performing model upload.

The following is an example what parameters to change from -Xmx200m to -Xmx1800m:

From:

```
X_ARGS="-Xms200m"
```

```
X_ARGS=" \"$X_ARGS\" $DELIM -Xmx200m"
```

To:

```
X_ARGS="-Xms200m"
```

```
X_ARGS=" \"$X_ARGS\" $DELIM -Xmx1800m"
```

2. Re-run `reveleusstartup.sh` to restart the Infrastructure server.

Steps to Change the Java Setting on Client:

1. Change the setting for Client PC where model upload will be executed.

Navigation: Go to Control Panel -> Java ->Java Tab:

2. Update Java Runtime Parameter for JRE 1.6.0_07

The following is an example to update the parameter to `-Xmx800m`.

Product Name: JRE

Version: 1.6.0_07

Location: C:\Program Files\Java\jre1.6.0_07

Java Runtime Parameters: `-Xmx800m`

Configuration for Dimension and Hierarchy Management

Open the file `AMHMConfig.properties` present in the `$FIC_WEB_HOME/webroot/conf` directory to set the properties for the following.

- Member Deletion
- Attribute Default Date Format
- Members Reverse Population
- Hierarchy Reverse Population
- Maximum levels allowed in Hierarchies
- Node Limit for a Hierarchy Tree
 - Configuration for Dimension and Hierarchy Management has to be done only after the application/solution installation is done.
 - These properties are specific to infodom
 - `$INFODOM$` = Name of the infodom.
 - `$DIMENSION_ID$`=Dimension ID for which the property to be set.

Configuring Member Deletion

This property should be set to allow the user to delete the Members for the Dimension

VALUE	CODE	EXAMPLE
# Member Deletion Configuration - VALUE- Y/N	MEMBER_DEL-\$INFODOM\$ -\$DIMENSION_ID\$=\$VALUE\$	MEMBER_DEL-ORAFUSION -1=Y

Configuring Attribute Default Date Format

This property should be set to display the Default Date Format for Date type Attribute in Attributes screen.

VALUE	CODE	EXAMPLE
# Attribute Default Date Format - DB_DATE_FORMAT:DD-MO N-YYYY	ATTR_DEF_DATE_FORMAT -\$INFODOM\$=\$DB_DATE_F ORMAT\$	ATTR_DEF_DATE_FORMAT -ORAFUSION=DD/MON/YY YY

Configuring Members Reverse Population

This property should be set for reverse population of Members for the Dimensions in required Information Domains.

VALUE	CODE	EXAMPLE
# Members Reverse population - VALUE- Y/N	MEMBER_REVERSE_POP-\$I NFODOM\$-\$DIMENSION_I D\$=\$VALUE\$	MEMBER_REVERSE_POP-O RAFUSION-1=Y

Configuring Hierarchy Reverse Population

This property should be set for reverse population of Hierarchies for the Dimensions in required Information Domains.

VALUE	CODE	EXAMPLE
-------	------	---------

#Hierarchy Reverse population - VALUE- Y/N	HIERARCHY_REVERSE_PO P-\$INFODOM\$-\$DIMENSIO N_ID\$=\$VALUE\$	HIERARCHY_REVERSE_PO P-ORAFUSION-1=Y
---	--	---

Configuring Maximum Levels allowed in Hierarchies

This property is required to set the maximum levels allowed to build the Hierarchies tree structure.

VALUE	CODE	EXAMPLE
#Hierarchy Maximum level allowed for the hierarchy in particular infodom - VALUE - Integer number	MAX_DEPTH-\$INFODOM\$= \$VALUE\$	MAX_DEPTH-FUSION=15

- The Maximum Levels allowed in the hierarchies is less than or equal to 15. If the Hierarchy Reverse population is set as "Y" and more than 15 levels are created then the alert will be displayed as "The number of levels exceeding the limit".
- If the maximum level allowed is set as more than 15 and hierarchy reverse population is set as "Y" then an error will be displayed as "Error occurred in Reverse populating the hierarchy"

Configuring Node Limit for a Hierarchy Tree

This property is required to display the Hierarchy as a small or a large hierarchy. If the tree node limit exceeds the set limit, Hierarchies are treated as large Hierarchy.

VALUE	CODE	EXAMPLE
#Tree node limit for the hierarchy - Values is Integer number	TREE_NODE_LIMIT=\$VALU E\$	TREE_NODE_LIMIT=30

Frequently Asked Questions

Introduction

This article is attempted to help with answers in resolving few of the OFSAAI Installation and configuration issues. This is not an official OFSAAI support site. We have made an attempt to share knowledge and help others on solving problems.

What is Oracle Financial Services Analytical Applications Infrastructure?

Oracle Financial Services Analytical Applications Infrastructure powers the Oracle Financial Services Analytical Applications family of products. It performs the processing, categorizing, selection and manipulation of data and information needed to analyze, understand and report on specific performance, risk, compliance and customer insight issues.

What is the purpose of OFSAA Infrastructure?

Oracle Financial Services analytical applications infrastructure helps control data quality and provides a consistent approach across applications for assigning business assumptions and accessing shared data for computations underlying Oracle's Financial Services analytical applications

Infrastructure is comprised of a set of frameworks that operates on and with the Oracle Financial Services Analytical Applications Data Model. This infrastructure delivers unified metadata across the stack and provides a single set of computational engines, stochastic modeling methods and business rules to feed overlapping, but independent, analytical business functions such as profitability, economic capital, FTP, and regulatory capital. Pre-integrated and extensible with common objects and dimensions, this infrastructure powers business user analyses with performance that scales to meet the demands of the world's largest institutions.

OFSAAI Installation FAQ's

Where can I get more information on OFSAA Infrastructure?

More information is available on the oracle.com web site.

What are the different components that get installed during OFSAA Infrastructure?

OFSAA Infrastructure installation processes are categorized into three layers - Infrastructure Web Server, Infrastructure Application Server and Infrastructure Database Server components.

What are the different modes of OFSAA Infrastructure installation?

Infrastructure components can be installed on a single machine (referred to as the single-tier mode) or on multiple machines (referred to as the multi-tier mode).

Is JDK required during installation of OFSAA Infrastructure and can it be uninstalled after OFSAA Infrastructure installation?

Yes, JDK is required during installation of OFSAA Infrastructure as well after installation for the application to work.

What are the different files required to perform OFSAA Infrastructure Installation?

Setup.sh, OFSAAInfrastructure.bin, libcpptripledes.so and CustReg.DAT

Is OFSAA Infrastructure license Application specific?

Yes, OFSAA Infrastructure license is application specific.

Execution of ./Setup.sh exits without proceeding with installation, what needs to be done?

- If error message resembles "Execute Permission denied" then check whether all the files provided for OFSAA Infrastructure installation has execute permissions.
- If error resembles "Graphical installers are not supported by the VM. The console mode will be used instead..." then check whether any of the X-windows software has been installed eg: Hummingbird Exceed is started and configured to Graphical mode installation.

Note: Type 'xclock' from prompt and this should display clock in graphical mode.

- If error resembles "No Java virtual machine could be found from your PATH environment variable. You must install a VM prior to running this program", then check whether java path is set in PATH variable. For details on setting the environment variables, refer to the OFSAA Infrastructure Installation guide, under section pre-requisites.
- Check whether sufficient temporary space is available.
- Ensure the movement of OFSAA Infrastructure Installer text files to the target system is done in the Text mode so that Setup.sh file does not contain control line feed characters (^M).

During installation if error message shows "OracleDriver Files Not Found,Please Choose The Right Path To Continue" ?

Check whether the provided path for Oracle Driver files is correct and whether the user has permissions to access the files.

During installation if error always resembles "User must have CREATE TABLE, CREATE VIEW, CREATE TRIGGER, CREATE INDEX, CREATE SEQUENCE, CREATE PROCEDURE " though the oracle schema user created has the mentioned privileges?

OFSAA Infrastructure installer validates the database details provided during installation, so ensure

- Whether the oracle schema user has the required set of privileges for successful installation.
- Whether the oracle schema user has been created with quota privileges on table space to create database objects.

Detailed instructions can be found in the Pre-requisite Steps of Oracle Financial Services Analytical Applications Infrastructure Installation Manual.

What when error message resembles "java.lang.Exception: [TripleDES] cpptripledes Library not loaded" during OFSAA Infrastructure installation?

OFSAA Infrastructure Installer loads the libcptripledes.so file provided for installation, so ensure the following:

- Libcptripledes.so file has execute permissions.

- Whether the JAVA version set in the PATH variable is same on which OFSAA Infrastructure was qualified.

Detailed instructions of the software's on which OFSAA Infrastructure is qualified can be found in Software Environments section of Oracle Financial Services Analytical Applications Infrastructure Installation Manual.

Installation of OFSAA Infrastructure was completed successfully! What next?

Post the successful completion of OFSAA Infrastructure, one has to perform the Post Installation Steps. Detailed instructions can be found in the Post Installation Steps , page 10-1of Oracle Financial Services Analytical Applications Infrastructure Installation Manual.

OFSAA Infrastructure Installation is unsuccessful?

OFSAA Infrastructure installer generates log files in the Infrastructure Installation Directory. The installer generates logs namely OFSAAInfrastructure_Install.log and configReveleus.log. Any of these reported, Warnings / Non Fatal Errors / Fatal Errors / Exceptions in each of these logs should be brought to the notice of the OFSAAI Infrastructure Support. Recommended not to proceed, until the reported problems are adequately addressed.

How do I Completely Uninstall OFSAA Infrastructure?

OFSAA Infrastructure can be completely uninstalled by performing the steps provided in the Uninstalling Infrastructure Components of Oracle Financial Services Analytical Applications Infrastructure Installation Manual.

OFSAAI Configuration FAQ's

On the UNIX System terminal, Error message shows `./reveleusstartup.sh: /java: Execute permission denied` while executing `./reveleusstartup.sh` file.

- Ensure JAVA_BIN environment variable path is set on the unix user terminal from where the reveleusstartup.sh file is invoked.
- Ensure the .profile where the environment / path settings are made has been executed successfully.

OFSAAI Application server (Infrastructure Server) does not proceed after providing the system password?

- System Password provided when prompted should match with the Oracle Config

password provided during installation and check whether connection to the Config schema can be established through sqlplus.

- If Revappserver log under \$FIC_APP_HOME/common/FICServer/logs displays error message resembling "java.lang.Exception: [TripleDES] cpptripledes Library not loaded" check whether JAVA_BIN path selected during installation is same as mentioned in the Oracle Financial Services Analytical Applications Infrastructure Installation and Configuration Guide.

When logging into OFSAA Infrastructure with valid user id and password, pop-up window displays message as cpptripledes could not be loaded?

Applicable if Websphere is chosen as web server,

- libcpptripledes.so file should be copied from \$FIC_WEB_HOME/bin into <WebSphere installation path>/AppServer/bin
- Make sure the Websphere java version is same as mentioned in the Oracle Financial Services Analytical Applications Infrastructure Installation and Configuration Guide.

Applicable if Tomcat is chosen as web server,

- LIBPATH/LD_LIBRARY_PATH should be set to \$FIC_WEB_HOME/bin on the terminal where the tomcat server will be started.
- Make sure the java version on which tomcat server is pointing should be same as mentioned in the Oracle Financial Services Analytical Applications Infrastructure Installation and Configuration Guide.

OFSAA Infrastructure installation completed successfully, however when OFSAA Infrastructure servers are started and the application URL is accessed, gives an error "the page cannot be found or displayed" or "Could not retrieve list of languages from Server. Please contact the system administrator".

- Ensure OFSAA Infrastructure servers are started and running successfully. On the server start up parameters options, please refer to Starting Infrastructure , page 11-1 of Oracle Financial Services Analytical Applications Infrastructure Installation and Configuration Guide.
- Further details on the issue, refer on to the Revappserver log in \$FIC_APP_HOME/common/FICServer/logs directory or the Web Server log files.

Is it necessary to provide the specified grants to the Oracle schema user before installation, if yes, can it be revoked after completion of installation?

Oracle schema user requires the necessary grants specified before, during and after the installation process. Grants provided should never be revoked as the application makes use of these grants all the time.

Can we have distributed OFSAA Infrastructure Application Server for load balancing?

OFSAA Infrastructure Application server can be scaled out/distributed across different JVM's (machines) based on the various services and information domains, in other words Load balancing could be achieved with distribution of services. Further instructions on setting up the distributed environment can be referred to Oracle Financial Services Analytical Applications Infrastructure Installation and Configuration Guide.

Why do we need ftpshare? Why on all the layers? Can we have ftpshare on another machine other than the machines where OFSAAI is installed?

All the files used in Infrastructure are stored in the FTP folders. The ftpshare folder is a metadata repository directory that contains folders for each information domain. Each information domain folder holds a corresponding Erwin, log, and scripts folder. For any ETL operation, the data needs to be transferred from the client to the database. The entities, such as Tables, are generated in the Database Layer. The transfer of data among the three servers in Infrastructure takes place through FTP/SFTP. Hence it is required to have an ftpshare folder in each Infrastructure server. Full permissions should be granted to this directory and its sub folders and files.

Bind exception, port binding issues, Can the ports used by Infrastructure services changed after the installation process?

Port Change utility could be used to have the Port number modified, which are currently being used by the Infrastructure application. On Further instruction, refer to Configuration of Infrastructure Ports , page 10-4in Oracle Financial Services Analytical Applications Infrastructure Installation and Configuration Guide.

Are there any in-built system administration users within OFSAA Infrastructure Application?

Two in-built system administration users are provided to configure and setup the OFSAA Infrastructure

- SYSADMN: <no password>
- SYSAUTH: <no password>

Does OFSAA Infrastructure Application support both FTP and SFTP?

OFSAA Infrastructure supports both FTP and SFTP configuration. Further instructions refer to Oracle Financial Services Analytical Applications Infrastructure Installation and Configuration Guide

Enabling the FTP/SFTP services.

Yes, enabling of FTP/SFTP services and its ports is a pre-requisite step towards using the OFSAA Infrastructure. OFSAAI Installation and Configuration Guide gives the steps in enabling these services

OFSAAI Configuration, Unable to save the server details?

- Ensure the input user id, password and share name are correct.
- Ensure FTP/SFTP services are enabled.
- Have a test FTP/SFTP connection made and confirm if they are successful.

During Information Domain creation, message appears "Please create a database and then create the information domain"?

Information Domain is mapped to only one Database; and thus before the creation of Information Domain, at least one database details would need to exist.

"ConnectToDatabase: FatalError, could not connect to the DB server" during startup of backend engine message server?

- Verify whether connection to the Config schema can be established through sqlplus.
- Verify Config schema password is modified post installation.
- Ensure oracle database alias name created for oracle instance and oracle service name are same.
- On a multi tier Installation mode, ensure TNSNAME and SID are the same in both the Application and Database Layers.

" Fatal Error, failed to get user ID from LibSmsConnect" during startup of backend engine message server?

Ensure Reveleus.sec file exists under the \$FIC_HOME/conf directory where the Database components are installed.

Does OFSAA Infrastructure Application support LDAP authentication?

OFSAA Infrastructure supports LDAP configuration and authentication. Further instructions refer to Oracle Financial Services Analytical Applications Infrastructure Installation and Configuration Guide.

Does OFSAA Infrastructure support multi-lingual?

OFSAA Infrastructure supports multi-lingual. Currently English is the language on which OFSAA Infrastructure is certified.

Does OFSAA Infrastructure provide for any data back-up features?

OFSAA Infrastructure does not have built-in back-up facility. It's recommended external storage infrastructure for backups.

What kind of security features does your OFSAA Infrastructure provide?

OFSAA Infrastructure provides security at

- Segment Level - Users can access only the segment they are mapped to.
- Application Level - Users can perform an operation only if mapped to appropriate role and functions.

Does OFSAA Infrastructure have the ability to enforce periodic password change?

OFSAA Infrastructure provides configurable parameters to define number of days after which the user password would expire and then the user is forced to change the password after expiration period.

What is the password policy followed in OFSAA Infrastructure?

OFSAA Infrastructure enforces a minimum password length with a combination of Upper and Lower case characters and alpha-numeric string.

Which version of Erwin Data Modeller does OFSAA Infrastructure support?

The current certified CA Erwin versions are 7.1.2 and 7.3 via Patch: 9227983. Refer, Note 1070591.1 at <https://support.oracle.com>.

Tech stack doc was updated to include specific support of Erwin 7.1.2 and 7.3.0.

Does OFSAA Infrastructure provide mechanism to upload Business Data model?

OFSAA Infrastructure provides easy to use GUI based Model upload mechanism to

upload the Business Data Model.

Business Data model undergoes changes, how does this incremental change get applied to the existing model?

Modified data model can be uploaded into the system and OFSAA Infrastructure has the ability to compare the changes within the data model with respect to the one already present in the system and enables propagation of incremental changes in a consistent manner.

What are the different modes of uploading a business data model?

OFSAA Infrastructure supports uploading of business data model from client desktop and also by picking up the data model from the server location.

Does upload of Business Data model depend on Java Memory?

Business data model upload through OFSAA Infrastructure depends on the Java memory settings on the client and server machines. Java memory setting varies with the data model size and the available RAM. Please contact OFSAA Infrastructure support for more details. Please refer to Configuration of OFSAAI, for more details.

Defining Application Sources

Introduction

Application Sources must be created within Data Integrator in order for the Application Installation to copy the relevant files for the seeded loaders. For more information about the Data Integrator and Defining Sources, see *Oracle Financial Services Analytical Applications Infrastructure User Guide*.

Creating an Application Source

Follow the steps below to create the application sources that are necessary for the installation to copy the relevant files for the seeded loaders:

1. Verify user's group for the application user has been assigned ETL Analyst role. This allows the user to access the Data Integrator menu.
2. Confirm that an FS Data Model has already been successfully uploaded to the Information Domain.
3. Login as the application user and navigate to Unified Metadata Manager -> Technical Data Management -> Data Integrator.
4. Navigate to Source Designer -> Define Sources
5. Define Source Applications:
Create Applications: FSAPP_T2T and FUSION_APPS
6. Define Data Sources:
 - Enter the Atomic User for USER ID and Table Owner.

- Enter the Database Name for Database Name and Tnsname.
- Enter mm/dd/yyyy for Date Format.

Example

Example of FS_SOURCE - RDBMS Source Type

The screenshot shows a window titled "Edit Source - FS_SOURCE" with a "Data Source Details" section. The fields are filled with the following information:

- Source name: FS_SOURCE
- Description: FS_SOURCE RDBMS Source
- Server name: 10.143.92.19
- Server port: 1521
- FTP share: (empty)
- FTP drive: (empty)
- User ID: ofsaademo
- Password: (masked with asterisks)
- Database name: ofsa
- Table Owner: ofsaademo
- Source Date format: mm/dd/yyyy
- Database: Oracle
- JDBC Drivers: Oracle Driver
- TNSNAME: ofsa
- Locale: en_US

On the right side of the dialog, there are radio buttons for "Local" (selected) and "Remote". Below that is a "Source type" section with radio buttons for "RDBMS" (selected), "Non-RDBMS", and "Flat File". At the bottom of the dialog are three buttons: "Test Source", "Save", and "Cancel".

Example

Example of STAGING_SOURCE_F2T - Flat File to Table

The image shows a screenshot of a software dialog box titled "Edit Source - STAGING_SOURCE_F2T". The main heading is "Data Source Details". The form contains the following fields and options:

- Source name:** STAGING_SOURCE_F2T
- Description:** For Flat File
- Server name:** [Empty text box]
- Server port:** [Empty text box]
- FTP share:** [Empty text box]
- FTP drive:** [Empty text box]
- User ID:** [Empty text box]
- Password:** [Empty text box]
- Database name:** [Empty text box]
- Table Owner:** [Empty text box]
- Source Date format:** mm/dd/yyyy
- Database:** [Empty dropdown menu]
- JDBC Drivers:** [Empty dropdown menu]
- TNSNAME:** [Empty text box]
- Locale:** [Empty text box]

On the right side of the form, there are radio buttons for "Local" (selected) and "Remote". Below these is a "Source type" section with three radio buttons: "RDBMS", "Non-RDBMS", and "Flat File" (selected).

At the bottom of the dialog box, there are three buttons: "Test Source", "Save", and "Cancel".

Example

Example of STAGING_SOURCE_T2T - Table to Table for RDBMS Source Type

Edit Source - STAGING_SOURCE_T2T

Data Source Details

Source name
STAGING_SOURCE_T2T

Description
For Staging Table To Table

* Server name 10.143.92.19 Server port 1521

FTP share FTP drive

* User ID ofsademo Password *****

* Database name ofsaa Table Owner

* Source Date format mm/dd/yyyy

Database Oracle

JDBC Drivers Oracle Driver

TNSNAME ofsaa

* Locale en_US

Source type:
 Local RDBMS
 Non-RDBMS
 Flat File

Test Source Save Cancel

7. Navigate to Map Sources tab and Map the Source to the respective application:
 - Map data source FS_SOURCE to application FSAPP_T2T.
 - Map data sources STAGING_SOURCE_F2T and STAGING_SOURCE_T2T to application FUSION_APPS.
8. Generate Source Model for the following.
 - FS_SOURCE

- STAGING_SOURCE_T2T

Select the Erwin or Catalog option. For more information on Generating the Source Model, see *Oracle Financial Services Analytical Applications Infrastructure User Guide*.

- Application and Source names are not dynamic. They have to be the exact name as mentioned in the solution steps above.
- The installer assumes the application and sources have been created, thus deploys the ETL definitions into this source when you run setup.sh.
- The source recommended may be an RDBMS based source, in which case the source should be defined on the same schema as the one in which the solution is being installed.
- Once an application and source has been created in the framework, you cannot create a new application and source with the same name. The source created earlier will hence be re-used for installing the new OFS Applications, be it on an information domain (infodom) already containing an OFS Application or a new infodom. As a result, if you need to install an OFS Application into an infodom #2, there will be a mismatch since the pre-created source will point to schema of infodom #1.
- It is recommended for the current release, that you do not create multi-infodom installation unless you intend to do it on a non-production environment where ETL activities will NOT be performed through OFS Infrastructure.