

Oracle® Fusion Middleware

Administrator's Guide for Oracle Internet Directory

11g Release 1 (11.1.1)

E10029-03

January 2011

Oracle Fusion Middleware Administrator's Guide for Oracle Internet Directory, 11g Release 1 (11.1.1)

E10029-03

Copyright © 1999, 2011, Oracle and/or its affiliates. All rights reserved.

Primary Author: Ellen Desmond

Contributors: Olfat Aly, Krishna Chander, Giriraj Chauhan, Margaret Chou, Quan Dinh, Maud Jamati-Bartlett, Vinoth Janakiraman, Buddhika Kottahachchi, Venkat Medam, Vishal Parashar, Karthi Purushothaman, Lakshmi Ramadoss, Loganathan Ramasamy, Ramaprakash Sathyanarayan, Daniel Shih, Olaf Stullich, Dipankar Thakuria, Arun Theebaprakasam, Vinay Thulasidas, Satishkumar Venkatasamy, Frances Wu

This software and related documentation are provided under a license agreement containing restrictions on use and disclosure and are protected by intellectual property laws. Except as expressly permitted in your license agreement or allowed by law, you may not use, copy, reproduce, translate, broadcast, modify, license, transmit, distribute, exhibit, perform, publish, or display any part, in any form, or by any means. Reverse engineering, disassembly, or decompilation of this software, unless required by law for interoperability, is prohibited.

The information contained herein is subject to change without notice and is not warranted to be error-free. If you find any errors, please report them to us in writing.

If this software or related documentation is delivered to the U.S. Government or anyone licensing it on behalf of the U.S. Government, the following notice is applicable:

U.S. GOVERNMENT RIGHTS Programs, software, databases, and related documentation and technical data delivered to U.S. Government customers are "commercial computer software" or "commercial technical data" pursuant to the applicable Federal Acquisition Regulation and agency-specific supplemental regulations. As such, the use, duplication, disclosure, modification, and adaptation shall be subject to the restrictions and license terms set forth in the applicable Government contract, and, to the extent applicable by the terms of the Government contract, the additional rights set forth in FAR 52.227-19, Commercial Computer Software License (December 2007). Oracle USA, Inc., 500 Oracle Parkway, Redwood City, CA 94065.

This software is developed for general use in a variety of information management applications. It is not developed or intended for use in any inherently dangerous applications, including applications which may create a risk of personal injury. If you use this software in dangerous applications, then you shall be responsible to take all appropriate fail-safe, backup, redundancy, and other measures to ensure the safe use of this software. Oracle Corporation and its affiliates disclaim any liability for any damages caused by use of this software in dangerous applications.

Oracle is a registered trademark of Oracle Corporation and/or its affiliates. Other names may be trademarks of their respective owners.

This software and documentation may provide access to or information on content, products, and services from third parties. Oracle Corporation and its affiliates are not responsible for and expressly disclaim all warranties of any kind with respect to third-party content, products, and services. Oracle Corporation and its affiliates will not be responsible for any loss, costs, or damages incurred due to your access to or use of third-party content, products, or services.



RSA and RC4 are trademarks of RSA Data Security. Portions of Oracle Internet Directory have been licensed by Oracle Corporation from RSA Data Security.

This product contains SSLPlus Integration Suite™ version 1.2, from Consensus Development Corporation.

Contents

Preface	xxxvii
Audience	xxxvii
Documentation Accessibility	xxxvii
Related Documents	xxxviii
Conventions	xxxix
What's New in Oracle Internet Directory?	xli
New Features Introduced with Oracle Internet Directory 11g Release 1 (11.1.1.4.0)	xli
New Features Introduced with Oracle Internet Directory 11g Release 1 (11.1.1)	xlii
New Features Introduced with Oracle Internet Directory 10g (10.1.4.1)	xliv
New Features Introduced with Oracle Internet Directory 10g Release 2 (10.1.2)	xlvi
Part I Understanding Directory Services	
1 Introduction to Directory Services	
What Is a Directory?	1-1
The Expanding Role of Online Directories	1-1
The Problem: Too Many Special-Purpose Directories	1-2
What Is the Lightweight Directory Access Protocol (LDAP)?	1-3
LDAP and Simplified Directory Management	1-3
LDAP Version 3	1-3
What Is Oracle Internet Directory?	1-4
Overview of Oracle Internet Directory	1-4
Components of Oracle Internet Directory	1-5
Advantages of Oracle Internet Directory	1-5
Scalability	1-6
High Availability	1-6
Security	1-6
Integration with the Oracle Environment	1-6
How Oracle Products Use Oracle Internet Directory	1-6
Easier and More Cost-Effective Administration of Oracle Products	1-7
Tighter Security Through Centralized Security Policy Administration	1-7
Integration of Multiple Directories	1-8

2 Understanding Oracle Internet Directory in Oracle Fusion Middleware

WebLogic Server Domain	2-1
Oracle Internet Directory as a System Component	2-2
Oracle Internet Directory Deployment Options	2-2
Middleware Home	2-3
WebLogic Server Home	2-3
Oracle Common Home	2-3
Oracle Home	2-3
Oracle Instance	2-3
Oracle Enterprise Manager Fusion Middleware Control	2-4
Logging, Auditing, and Diagnostics	2-4
MBeans and the WebLogic Scripting Tool	2-4

3 Understanding Oracle Internet Directory Concepts and Architecture

Oracle Internet Directory Architecture	3-1
An Oracle Internet Directory Node	3-2
An Oracle Directory Server Instance	3-3
Oracle Internet Directory Ports	3-4
Directory Metadata	3-4
How Oracle Internet Directory Processes a Search Request	3-6
Directory Entries	3-7
Distinguished Names (DNs) and Directory Information Trees (DITs)	3-7
Entry Caching	3-8
Attributes	3-8
Kinds of Attribute Information	3-9
Single-Valued and Multivalued Attributes	3-10
Common LDAP Attributes	3-10
Attribute Syntax	3-11
Attribute Matching Rules	3-11
Attribute Options	3-11
Object Classes	3-12
Subclasses, Superclasses, and Inheritance	3-12
Object Class Types	3-13
Structural Object Classes	3-13
Auxiliary Object Classes	3-13
Abstract Object Classes	3-13
Naming Contexts	3-14
Security	3-14
Globalization Support	3-15
Distributed Directories	3-16
Directory Replication	3-16
Directory Partitioning	3-16
Knowledge References and Referrals	3-17
Oracle Delegated Administration Services and the Oracle Internet Directory Self-Service Console	3-19
The Service Registry and Service to Service Authentication	3-19
Oracle Directory Integration Platform	3-20

Oracle Internet Directory and Identity Management	3-20
About Identity Management	3-21
Oracle Identity Management Products	3-21
Identity Management Realms	3-23
Default Identity Management Realm.....	3-23
Identity Management Policies.....	3-23
Resource Information	3-24
Resource Type Information	3-24
Resource Access Information	3-24
Location of Resource Information in the DIT	3-24
4 Understanding Process Control of Oracle Internet Directory Components	
Oracle Internet Directory Process Control Architecture.....	4-1
The ODS_PROCESS_STATUS Table	4-2
Starting, Stopping, and Monitoring of Oracle Internet Directory Processes	4-3
Oracle Internet Directory Snippet in opmn.xml.....	4-3
OPMN Starting Oracle Internet Directory.....	4-4
OPMN Stopping of Oracle Internet Directory	4-4
Process Monitoring	4-5
Oracle Internet Directory Process Control–Best Practices.....	4-5
5 Understanding Oracle Internet Directory Organization	
The Directory Information Tree	5-1
Planning the Overall Directory Structure	5-2
Planning the Names and Organization of Users and Groups	5-3
Organizing Users.....	5-3
Organizing Groups	5-4
Migrating a DIT from a Third-Party Directory	5-5
6 Understanding Oracle Internet Directory Replication	
Why Use Replication?	6-2
Replication Concepts.....	6-2
Content to be Replicated: Full or Partial.....	6-2
Direction: One-Way, Two-Way, or Peer to Peer.....	6-3
Transport Mechanism: LDAP or Oracle Database Advanced Replication.....	6-4
Directory Replication Group (DRG) Type: Single-master, Multimaster, or Fan-out.....	6-4
Single-Master Replication Example	6-5
Multimaster Replication Example	6-5
Fan-out Replication Example	6-6
Loose Consistency Model	6-6
How the Replication Concepts Fit Together	6-6
Multimaster Replication with Fan-Out.....	6-7
What Kind of Replication Do You Need?.....	6-8

Part II Basic Administration

7 Getting Started With Oracle Internet Directory

Patching Your System to 11g Release 1 (11.1.1.4.0)	7-1
Deselecting Cipher Suites for SSL Server Authentication	7-1
Upgrading a Directory Replication Group	7-2
Postinstallation Tasks and Information	7-2
Setting Up the Environment	7-2
Starting and Stopping the Oracle Stack	7-2
Identifying Default URLs and Ports	7-2
Tuning Oracle Internet Directory	7-2
Enabling Anonymous Binds	7-3
Enabling Oracle Internet Directory to run on Privileged Ports	7-3
Verifying Oracle Database Time Zone	7-3
Using Fusion Middleware Control to Manage Oracle Internet Directory	7-4
Using Oracle Directory Services Manager	7-5
Introduction to Oracle Directory Services Manager	7-6
Using the JAWS Screen Reader with Oracle Directory Services Manager	7-6
Non-Super User Access to Oracle Directory Services Manager	7-6
Single Sign-On Integration with Oracle Directory Services Manager	7-6
Configuring ODSM for SSO Integration	7-7
Configuring the SSO Server for ODSM Integration	7-8
Configuring the Oracle HTTP Server for ODSM-SSO Integration	7-9
Invoking Oracle Directory Services Manager	7-9
Connecting to the Server from Oracle Directory Services Manager	7-9
Logging in to the Directory Server from Oracle Directory Services Manager	7-10
Logging Into the Directory Server from Oracle Directory Services Manager Using SSL	7-11
Connecting to an SSO-Enabled Directory as an SSO-Authenticated User	7-12
Configuring Oracle Directory Services Manager Session Timeout	7-12
Configuring Oracle HTTP Server to Support Oracle Directory Services Manager in an Oracle WebLogic Server Cluster	7-12
Using Command-Line Utilities to Manage Oracle Internet Directory	7-13
Using Standard LDAP Utilities	7-13
Using Bulk Tools	7-14
Using WLST	7-14
Basic Tasks for Configuring and Managing Oracle Internet Directory	7-15

8 Managing Oracle Internet Directory Instances

Introduction to Managing Oracle Internet Directory Instances	8-1
The Instance-Specific Configuration Entry	8-1
Creating the First Oracle Internet Directory Instance	8-2
Creating Additional Oracle Internet Directory Instances	8-3
Registering an Oracle Instance or Component with the WebLogic Server	8-4
Managing Oracle Internet Directory Components by Using Fusion Middleware Control	8-4
Viewing Active Server Information by Using Fusion Middleware Control	8-5
Starting the Oracle Internet Directory Server by Using Fusion Middleware Control	8-5
Stopping the Oracle Internet Directory Server by Using Fusion Middleware Control	8-5
Restarting the Oracle Internet Directory Server by Using Fusion Middleware Control	8-5

Managing Oracle Internet Directory Components by Using opmnctl	8-5
Creating an Oracle Internet Directory Component by Using opmnctl	8-6
Registering an Oracle Instance by Using opmnctl	8-7
Unregistering an Oracle Instance by Using opmnctl	8-7
Updating the Component Registration of an Oracle Instance by Using opmnctl	8-8
Deleting an Oracle Internet Directory Component by Using opmnctl	8-9
Viewing Active Server Instance Information by Using opmnctl	8-9
Starting the Oracle Internet Directory Server by Using opmnctl	8-9
Stopping the Oracle Internet Directory Server by Using opmnctl	8-10
Restarting the Oracle Internet Directory Server by Using opmnctl	8-10
Changing the Oracle Database Information in opmn.xml	8-10
Starting an Instance of the Replication Server by Using OIDCTL	8-10

9 Managing System Configuration Attributes

Introduction to Managing System Configuration Attributes	9-1
What are Configuration Attributes?	9-1
What are Operational Attributes?	9-2
Attributes of the Instance-Specific Configuration Entry	9-2
Attributes of the DSA Configuration Entry	9-9
Attributes of the DSE	9-10
Managing System Configuration Attributes by Using Fusion Middleware Control	9-11
Configuring Server Properties	9-11
Configuring Shared Properties	9-13
Configuring Other Parameters	9-14
Managing System Configuration Attributes by Using WLST	9-14
Managing System Configuration Attributes by Using LDAP Tools	9-16
Setting System Configuration Attributes by Using ldapmodify	9-16
Listing Configuration Attributes with ldapsearch	9-17
Managing System Configuration Attributes by Using ODSM Data Browser	9-18
Navigating to the Instance-Specific Configuration Entry	9-18
Navigating to the DSA Configuration Entry	9-18
Navigating to the DSE Root	9-18

10 Managing IP Addresses

Introduction to Managing IP Addresses	10-1
Configuring an IP Address for IP V6, Cold Failover Cluster, or Virtual IP	10-1

11 Managing Naming Contexts

Introduction to Managing Naming Contexts	11-1
Searching for Published Naming Contexts	11-1
Publishing a Naming Context	11-2

12 Managing Accounts and Passwords

Introduction to Managing Accounts and Passwords	12-1
Managing Accounts and Passwords by Using Command-Line Tools	12-2

Enabling and Disabling Accounts by Using Command-Line Tools.....	12-2
Unlocking Accounts by Using Command-Line Tools.....	12-3
Forcing a Password Change by Using Command-Line Tools.....	12-3
Managing Accounts and Passwords by Using the Self-Service Console.....	12-3
Enabling and Disabling Accounts by Using the Oracle Internet Directory Self-Service Console..	12-4
Unlocking Accounts by Using the Oracle Internet Directory Self-Service Console.....	12-4
Resetting Your Own Password by Using the Oracle Internet Directory Self-Service Console	12-4
Listing and Unlocking Locked Accounts by Using Oracle Directory Services Manager	12-4
Changing the Superuser Password by Using Fusion Middleware Control	12-5
Creating Another Account With Superuser Privileges	12-5
Managing the Superuser Password by Using ldapmodify	12-6
Changing the Oracle Internet Directory Database Password.....	12-6
Resetting the Superuser Password.....	12-7
Changing the Password for the EMD Administrator Account.....	12-7
Changing the Password for the ODSSM Administrator Account.....	12-8

13 Managing Directory Entries

Introduction to Managing Directory Entries	13-1
Managing Entries by Using Oracle Directory Services Manager	13-1
Displaying Entries by Using Oracle Directory Services Manager	13-2
Searching for Entries by Using Oracle Directory Services Manager	13-3
Importing Entries from an LDIF File by Using Oracle Directory Services Manager	13-5
Exporting Entries to an LDIF File by Using Oracle Directory Services Manager.....	13-5
Viewing Attributes for a Specific Entry by Using Oracle Directory Services Manager	13-5
Adding a New Entry by Using Oracle Directory Services Manager	13-6
Deleting an Entry or Subtree by Using Oracle Directory Services Manager.....	13-8
Adding an Entry by Copying an Existing Entry in Oracle Directory Services Manager	13-8
Modifying an Entry by Using Oracle Directory Services Manager	13-9
Managing Entries by Using LDAP Command-Line Tools	13-11
Listing All the Attributes in the Directory by Using ldapsearch	13-11
Listing Operational Attributes by Using ldapsearch.....	13-11
Attribute Case in ldapsearch Output	13-12
Adding a User Entry by Using ldapadd.....	13-12
Modifying a User Entry by Using ldapmodify	13-13
Adding an Attribute Option by Using ldapmodify	13-13
Deleting an Attribute Option by Using ldapmodify.....	13-13
Searching for Entries with Attribute Options by Using ldapsearch.....	13-13

14 Managing Dynamic and Static Groups

Introduction to Managing Dynamic and Static Groups	14-1
Static Groups.....	14-1
Schema Elements for Creating Static Groups	14-2
Dynamic Groups	14-2
Cached and Uncached Dynamic Groups	14-2
Enhancements to and Limitations of Dynamic Groups in Oracle Internet Directory ..	14-3

Schema Elements for Creating a Dynamic Group	14-4
Hierarchies	14-6
Querying Group Entries.....	14-7
orclMemberOf Attribute	14-7
When to Use Each Kind of Group	14-8
Managing Group Entries by Using Oracle Directory Services Manager	14-8
Creating Static Group Entries by Using Oracle Directory Services Manager	14-8
Modifying a Static Group Entry by Using Oracle Directory Services Manager	14-10
Creating Dynamic Group Entries by Using Oracle Directory Services Manager.....	14-10
Modifying a Dynamic Group Entry by Using Oracle Directory Services Manager.....	14-13
Managing Group Entries by Using the Command Line.....	14-13
Creating a Static Group Entry by Using ldapadd	14-13
Modifying a Static Group by Using ldapmodify.....	14-14
Creating a Dynamic Group Entry by Using ldapadd.....	14-15
Creating a Cached Dynamic Group Using labeledURI Attribute	14-15
Creating an Uncached Dynamic List Using labeledURI Attribute.....	14-15
Creating a Dynamic Group Using CONNECT BY String.....	14-15
Modifying a Dynamic Group by Using ldapmodify	14-16

15 Performing Bulk Operations

Introduction to Performing Bulk Operations	15-1
Changing Server Mode	15-2
Setting the Server Mode by Using Fusion Middleware Control.....	15-3
Setting the Server Mode by Using ldapmodify	15-3
Loading Data Into the Schema by Using bulkload	15-3
Importing an LDIF File by Using bulkload	15-6
Loading Data in Incremental or Append Mode By Using bulkload	15-7
Performing Index Verification By Using bulkload.....	15-8
Re-Creating Indexes By Using bulkload.....	15-8
Recovering Data After a Load Failure By Using bulkload	15-8
Modifying Attributes of a Large Number of Entries By Using bulkmodify.....	15-8
Adding a Description for All Entries Under a Specified Naming Context	15-9
Adding an Attribute for Entries Under a Specified Naming Context Matching a Filter	15-9
Replacing an Attribute for All Entries Under a Specified Naming Context	15-9
Deleting Entries or Attributes of Entries by Using bulkdelete.....	15-9
Deleting All Entries Under a Specified Naming Context by Using bulkdelete	15-10
Deleting Entries Under Naming Contexts and Making them Tombstone Entries.....	15-10
Dumping Data from Oracle Internet Directory to a File by Using ldifwrite	15-10
Dumping Part of a Specified Naming Context to an LDIF File.....	15-11
Dumping Entries Under a Specified Naming Context to an LDIF File.....	15-11
Creating and Dropping Indexes from Existing Attributes by Using catalog	15-11
Changing a Searchable Attribute into a Non-searchable Attribute	15-12
Changing a Non-searchable Attribute into a Searchable Attribute.....	15-12

16 Managing Collective Attributes

Introduction to Collective Attributes	16-1
--	-------------

The RFC Definition and Oracle Extensions	16-1
RFC 3671.....	16-1
Oracle Extensions.....	16-1
Defining the Collective Attribute Subentry.....	16-2
Using subtreeSpecification.....	16-2
Base	16-2
Minimum and Maximum	16-2
Specific Exclusions.....	16-3
Overriding a Collective Attribute.....	16-4
Managing Collective Attributes by Using the Command Line	16-4
Adding a Subentry by Using ldapadd	16-4
Modifying a Subentry by Using ldapmodify	16-4
17 Managing Alias Entries	
Introduction to Managing Alias Entries	17-1
Adding an Alias Entry	17-2
Searching the Directory with Alias Entries.....	17-3
Searching the Base with Alias Entries	17-3
Searching One-Level with Alias Entries	17-4
Searching a Subtree with Alias Entries	17-5
Modifying Alias Entries	17-6
Interpreting Messages Related to Alias Dereferencing.....	17-6
18 Managing Attribute Uniqueness Constraint Entries	
Introduction to Managing Attribute Uniqueness Constraint Entries	18-1
Specifying Attribute Uniqueness Constraint Entries	18-3
Specifying Multiple Attribute Names in an Attribute Uniqueness Constraint	18-4
Specifying Multiple Subtrees in an Attribute Uniqueness Constraint.....	18-4
Specifying Multiple Scopes in an Attribute Uniqueness Constraint.....	18-5
Specifying Multiple Object Classes in an Attribute Uniqueness Constraint.....	18-5
Specifying Multiple Subtrees, Scopes, and Object Classes in an Attribute Uniqueness Constraint	18-6
Managing an Attribute Uniqueness Constraint Entry by Using Oracle Directory Services Manager.....	18-6
Creating an Attribute Uniqueness Constraint Entry by Using ODSM	18-6
Modifying an Attribute Uniqueness Constraint Entry by Using ODSM.....	18-7
Deleting an Attribute Uniqueness Constraint Entry by Using ODSM	18-7
Managing an Attribute Uniqueness Constraint Entry by Using the Command Line	18-7
Creating Attribute Uniqueness Across a Directory by Using Command-Line Tools.....	18-7
Creating Attribute Uniqueness Across One Subtree by Using Command-Line Tools.....	18-8
Creating Attribute Uniqueness Across One Object Class by Using Command-Line Tools	18-8
Modifying Attribute Uniqueness Constraint Entries by Using Command-Line Tools.....	18-9
Deleting Attribute Uniqueness Constraint Entries by Using Command-Line Tools.....	18-9
Enabling and Disabling Attribute Uniqueness by Using Command-Line Tools	18-9

19 Managing Knowledge References and Referrals

Introduction to Managing Knowledge References and Referrals	19-1
Configuring Smart Referrals.....	19-3
Configuring Default Referrals.....	19-4

20 Managing Directory Schema

Introduction to Managing Directory Schema	20-1
Where Schema Information is Stored in the Directory	20-2
Understanding Object Classes.....	20-2
About Adding Object Classes	20-3
About Modifying Object Classes	20-4
About Deleting Object Classes.....	20-4
Understanding Attributes	20-4
About Adding Attributes.....	20-5
About Modifying Attributes	20-5
About Deleting Attributes	20-5
About Indexing Attributes	20-6
Extending the Number of Attributes Associated with Entries.....	20-6
Extending the Number of Attributes before Creating Entries in the Directory	20-7
Extending the Number of Attributes for Existing Entries by Creating an Auxiliary Object Class	20-7
Extending the Number of Attributes for Existing Entries by Creating a Content Rule	20-8
Rules for Creating and Modifying Content Rules	20-8
Schema Enforcement When Using Content Rules	20-9
Searches for Object Classes Listed in Content Rules	20-9
Understanding Attribute Aliases	20-10
Object Identifier Support in LDAP Operations	20-10
Managing Directory Schema by Using Oracle Directory Services Manager	20-10
Searching for Object Classes by Using Oracle Directory Services Manager	20-11
Adding Object Classes by Using Oracle Directory Services Manager	20-11
Modifying Object Classes by Using Oracle Directory Services Manager	20-12
Deleting Object Classes by Using Oracle Directory Services Manager.....	20-13
Viewing Properties of Object Classes by Using Oracle Directory Services Manager	20-13
Adding a New Attribute by Using Oracle Directory Services Manager	20-13
Modifying an Attribute by Using Oracle Directory Services Manager.....	20-14
Deleting an Attribute by Using Oracle Directory Services Manager	20-14
Viewing All Directory Attributes by Using Oracle Directory Services Manager	20-15
Searching for Attributes by Using Oracle Directory Services Manager.....	20-15
Adding an Index to a New Attribute by Using Oracle Directory Services Manager.....	20-15
Adding an Index to an Existing Attribute by Using Oracle Directory Services Manager	20-15
Dropping an Index from an Attribute by Using Oracle Directory Services Manager	20-16
Creating a Content Rule by Using Oracle Directory Services Manager	20-16
Modifying a Content Rule by Using Oracle Directory Services Manager	20-16
Viewing Matching Rules by Using Oracle Directory Services Manager	20-17
Viewing Syntaxes by Using Oracle Directory Services Manager	20-17
Managing Directory Schema by Using the Command Line	20-17

Viewing the Schema by Using ldapsearch	20-18
Adding a New Object Class by Using Command-Line Tools	20-18
Adding a New Attribute to an Auxiliary or User-Defined Object Class by Using Command-Line Tools	20-19
Modifying Object Classes by Using Command-Line Tools	20-19
Adding and Modifying Attributes by Using ldapmodify	20-19
Deleting Attributes by Using ldapmodify	20-20
Indexing an Attribute for Which <i>No</i> Data Exists by Using ldapmodify	20-20
Dropping an Index from an Attribute by Using ldapmodify	20-21
Indexing an Attribute for Which Data Exists by Using the Catalog Management Tool	20-21
Adding a New Attribute With Attribute Aliases by Using the Command Line	20-21
Adding or Modifying Attribute Aliases in Existing Attributes by Using the Command Line	20-22
Deleting Attribute Aliases by Using the Command Line	20-22
Using Attribute Aliases with LDAP Commands	20-22
Using Attribute Aliases with ldapsearch	20-23
Using Attribute Aliases with ldapadd	20-24
Using Attribute Aliases with ldapmodify	20-24
Using Attribute Aliases with ldapdelete	20-25
Using Attribute Aliases with ldapmoddn	20-25
Managing Content Rules by Using Command-Line Tools	20-25
Viewing Matching Rules by Using ldapsearch	20-26
Viewing Syntaxes by Using ldapsearch	20-26

21 Configuring Referential Integrity

Introduction to Configuring Referential Integrity	21-1
Enabling Referential Integrity by Using Fusion Middleware Control	21-2
Disabling Referential Integrity by Using Fusion Middleware Control	21-2
Enabling Referential Integrity by Using the Command Line	21-2
Configuring Specific Attributes for Referential Integrity by Using the Command Line	21-3
Disabling Referential Integrity by Using the Command Line	21-3
Detecting and Correcting Referential Integrity Violations	21-3

22 Managing Auditing

Introduction to Auditing	22-1
Configuring the Audit Store	22-2
Oracle Internet Directory Audit Configuration	22-2
Replication and Oracle Directory Integration Platform Audit Configuration	22-3
Audit Record Fields	22-3
Audit Record Storage	22-3
Generating Audit Reports	22-4
Managing Auditing by Using Fusion Middleware Control	22-4
Managing Auditing by Using WLST	22-5
Managing Auditing from the Command Line	22-5
Viewing Audit Configuration from the Command Line	22-5
Configuring Oracle Internet Directory Auditing from the Command Line	22-6
Enabling Replication and Oracle Directory Integration Platform Auditing	22-6

23 Managing Logging

Introduction to Logging	23-1
Features of Oracle Internet Directory Debug Logging	23-2
Interpreting Log Messages	23-2
Log Messages for Specified LDAP Operations.....	23-3
Log Messages Not Associated with Specified LDAP Operations	23-3
Example: Trace Messages in Oracle Internet Directory Server Log File.....	23-3
Managing Logging by Using Fusion Middleware Control	23-4
Viewing Log Files by Using Fusion Middleware Control	23-5
Configuring Logging by Using Fusion Middleware Control.....	23-5
Managing Logging from the Command Line	23-6
Viewing Log Files from the Command Line	23-6
Setting Debug Logging Levels by Using the Command Line	23-6
Setting the Debug Operation by Using the Command Line.....	23-7
Force Flushing the Trace Information to a Log File	23-8

24 Monitoring Oracle Internet Directory

Introduction to Monitoring Oracle Internet Directory Server	24-1
Capabilities of Oracle Internet Directory Server Manageability	24-1
Oracle Internet Directory Server Manageability Architecture and Components.....	24-2
Purging of Security Events and Statistics Entries.....	24-4
Account Used for Accessing Server Manageability Information.....	24-4
Setting Up Statistics Collection by Using Fusion Middleware Control	24-4
Configuring Directory Server Statistics Collection by Using Fusion Middleware Control .	24-4
Configuring a User for Statistics Collection by Using Fusion Middleware Control	24-5
Viewing Statistics Information with Fusion Middleware Control	24-6
Viewing Statistics Information on the Oracle Internet Directory Home Page.....	24-6
Viewing Information on the Oracle Internet Directory Performance Page.....	24-6
Viewing Statistics Information from the Oracle Directory Services Manager Home Page...	24-7
Setting Up Statistics Collection by Using the Command-Line	24-7
Configuring Health, General, and Performance Statistics Attributes	24-8
Configuring Security Events Tracking.....	24-8
Configuring User Statistics Collection from the Command Line	24-9
Configuring Event Levels from the Command Line	24-9
Configuring a User for Statistics Collection by Using the Command Line.....	24-10
Viewing Information with the OIIDDIAG Tool	24-10

25 Backing Up and Restoring Oracle Internet Directory

Introduction to Backing Up and Restoring Oracle Internet Directory	25-1
Backing Up and Restoring a Small Directory or Specific Naming Context	25-1
Backing Up and Restoring a Large Directory	25-2

Part III Advanced Administration: Security

26 Configuring Secure Sockets Layer (SSL)

Introduction to Configuring Secure Sockets Layer (SSL)	26-1
Supported Cipher Suites	26-2
Supported Protocol Versions.....	26-2
SSL Authentication Modes	26-3
Limitations of the Use of SSL in 11g Release 1 (11.1.1).....	26-4
Oracle Wallets.....	26-4
Other Components and SSL	26-4
SSL Interoperability Mode.....	26-5
StartTLS	26-5
Configuring SSL by Using Fusion Middleware Control	26-5
Creating a Wallet by Using Fusion Middleware Control	26-6
Configuring SSL Parameters by Using Fusion Middleware Control	26-7
Setting SSL Parameters with Fusion Middleware Control	26-8
Configuring SSL by Using WLST	26-8
Configuring SSL by Using LDAP Commands	26-10
Testing SSL Connections by Using Oracle Directory Services Manager	26-11
Testing SSL Connections From the Command Line	26-11
Testing SSL With Encryption Only.....	26-12
Testing SSL With Server Authentication	26-12
Testing SSL With Client and Server Authentication.....	26-12
Configuring SSL Interoperability Mode	26-13

27 Configuring Data Privacy

Introduction to Table Space Encryption	27-1
Enabling and Disabling Table Space Encryption	27-1
Introduction to Using Database Vault With Oracle Internet Directory	27-3
Configuring Oracle Database Vault to Protect Oracle Internet Directory Data	27-3
Registering Oracle Database Vault.....	27-3
Adding a Database Vault Realm and Policies for Oracle Internet Directory	27-4
Managing Oracle Database Vault Configuration for Oracle Internet Directory	27-5
Deleting Database Vault Policies For Oracle Internet Directory.....	27-5
Disabling Oracle Database Vault for the Oracle Internet Directory Database.....	27-5
Best Practices for Using Database Vault with Oracle Internet Directory	27-5
Introduction to Sensitive Attributes	27-6
List of Sensitive Attributes.....	27-6
Encryption Algorithm for Sensitive Attributes	27-6
Configuring Privacy of Retrieved Sensitive Attributes	27-7
Introduction to Hashed Attributes	27-7
Configuring Hashed Attributes	27-8
Configuring Hashed Attributes by Using Fusion Middleware Control.....	27-8
Configuring Hashed Attributes by Using ldapmodify	27-8

28 Managing Password Policies

Introduction to Managing Password Policies	28-1
What a Password Policy Is.....	28-1

Steps Required to Create and Apply a Password Policy.....	28-2
Fine-Grained Password Policies	28-2
Default Password Policy	28-4
Password Policy Attributes	28-5
Password Policy-Related Operational Attributes	28-7
Directory Server Verification of Password Policy Information.....	28-7
Password Policy Error Messages	28-8
Releases Before 10g (10.1.4.0.1)	28-8
Managing Password Policies by Using Oracle Directory Services Manager	28-9
Viewing Password Policies by Using Oracle Directory Services Manager	28-9
Modifying Password Policies by Using Oracle Directory Services Manager	28-9
Creating a Password Policy and Assigning it to a Subtree by Using ODSM.....	28-10
Managing Password Policies by Using Command-Line Tools	28-10
Viewing Password Policies by Using Command-Line Tools	28-11
Creating a New Password Policy by Using Command-Line Tools.....	28-11
Applying a Password Policy to a Subtree by Using Command-Line Tools.....	28-11
Setting Password Policies by Using Command-Line Tools.....	28-12

29 Managing Directory Access Control

Introduction to Managing Directory Access Control	29-1
Access Control Management Constructs.....	29-2
Access Control Policy Points (ACPs).....	29-3
The orclACI Attribute for Prescriptive Access Control.....	29-3
The orclEntryLevelACI Attribute for Entry-Level Access Control	29-3
Security Groups.....	29-4
Access Control Information Components	29-7
Object: To What Are You Granting Access?	29-7
Subject: To Whom Are You Granting Access?.....	29-8
Operations: What Access Are You Granting?.....	29-10
Access Level Requirements for LDAP Operations	29-11
How ACL Evaluation Works	29-12
Precedence Rules Used in ACL Evaluation	29-12
Use of More Than One ACI for the Same Object	29-14
Exclusionary Access to Directory Objects	29-15
ACL Evaluation For Groups	29-15
Managing Access Control by Using Oracle Directory Services Manager.....	29-15
Viewing an ACP by Using Oracle Directory Services Manager	29-15
Adding an ACP by Using Oracle Directory Services Manager.....	29-16
Task 1: Specify the Entry That Will Be the ACP	29-16
Task 2: Configure Structural Access Items.....	29-16
Task 3: Configure Content Access Items	29-18
Delete a Structural or Content Access Item	29-19
Modifying an ACP by Using Access Control Management in ODSM.....	29-20
Adding or Modifying an ACP by Using the Data Browser in ODSM	29-21
Setting or Modifying Entry-Level Access by Using the Data Browser in ODSM.....	29-21
Managing Access Control by Using Command-Line Tools	29-22
Restricting the Kind of Entry a User Can Add	29-22

Setting Up an Inheritable ACP by Using ldapmodify	29-23
Setting Up Entry-Level ACIs by Using ldapmodify	29-23
Using Wildcards in an LDIF File with ldapmodify	29-23
Selecting Entries by DN	29-24
Using Attribute and Subject Selectors.....	29-24
Granting Read-Only Access.....	29-25
Granting Selfwrite Access to Group Entries	29-25
Defining a Completely Autonomous Policy to Inhibit Overriding Policies.....	29-25

30 Managing Password Verifiers

Introduction to Password Verifiers for Authenticating to the Directory	30-1
Userpassword Verifiers and Authentication to the Directory.....	30-2
Hashing Schemes for Creating Userpassword Verifiers	30-2
Managing Hashing Schemes for Password Verifiers for Authenticating to the Directory	30-3
Introduction to Password Verifiers for Authenticating to Components	30-3
About Password Verifiers for Authenticating to Oracle Components	30-4
Attributes for Storing Password Verifiers for Authenticating to Oracle Components.....	30-5
Default Verifiers for Oracle Components.....	30-7
How Password Verification Works for an Oracle Component.....	30-8
Managing Password Verifier Profiles for Oracle Components by Using ODSM	30-9
Managing Password Verifier Profiles for Components by Using Command-Line Tools.....	30-10
Viewing a Password Verifier Profile by Using Command-Line Tools	30-10
Example: Modifying a Password Verifier Profile by Using Command-Line Tools	30-10
Introduction to Generating Verifiers by Using Dynamic Parameters	30-10
Configuring Oracle Internet Directory to Generate Dynamic Password Verifiers	30-11

31 Delegating Privileges for Oracle Identity Management

Introduction to Delegating Privileges for Oracle Identity Management	31-1
How Delegation Works.....	31-1
Delegation in an Oracle Fusion Middleware Environment.....	31-2
About the Default Configuration.....	31-3
Privileges for Administering the Oracle Technology Stack.....	31-3
Delegating Privileges for User and Group Management.....	31-4
How Privileges Are Granted for Managing User and Group Data	31-4
Default Privileges for Managing User Data	31-5
Creating Users for a Realm.....	31-5
Modifying Attributes of a User.....	31-5
Deleting a User	31-6
Delegating User Administration.....	31-6
Default Privileges for Managing Group Data.....	31-7
Creating Groups.....	31-7
Modifying the Attributes of Groups	31-7
Deleting Groups	31-7
Delegating Group Administration	31-8
Delegating Privileges for Deployment of Oracle Components	31-8
How Deployment Privileges Are Granted	31-9
Oracle Application Server Administrators.....	31-9

User Management Application Administrators	31-10
Trusted Application Administrators	31-10
Delegating Privileges for Component Run Time	31-10
Default Privileges for Reading and Modifying User Passwords	31-11
Default Privileges for Comparing User Passwords	31-12
Default Privileges for Comparing Password Verifiers	31-12
Default Privileges for Proxying on Behalf of End Users	31-13
Default Privileges for Managing the Oracle Context	31-13
Default Privileges for Reading Common User Attributes	31-13
Default Privileges for Reading Common Group Attributes	31-14
Default Privileges for Reading the Service Registry	31-14
Default Privileges for Administering the Service Registry	31-14

32 Managing Authentication

Introduction to Authentication	32-1
Direct Authentication	32-1
Indirect Authentication	32-3
External Authentication	32-4
Simple Authentication and Security Layer (SASL)	32-5
Configuring Certificate Authentication Method by Using Fusion Middleware Control	32-6
Configuring SASL Authentication by Using Fusion Middleware Control	32-6
Configuring Certificate Authentication Method by Using Command-Line Tools	32-6
Configuring SASL Authentication by Using the Command Line	32-7
Introduction to Anonymous Binds	32-8
Managing Anonymous Binds	32-8
Managing Anonymous Binds by Using Fusion Middleware Control	32-8
Managing Anonymous Binds by Using the Command Line	32-8

Part IV Advanced Administration: Managing Directory Deployment

33 Planning, Deploying and Managing Realms

Introduction to Planning, Deploying and Managing Realms	33-1
Planning the Identity Management Realm	33-1
Identity Management Realms in an Enterprise Deployment	33-3
Single Identity Management Realm in the Enterprise	33-3
Multiple Identity Management Realms in the Enterprise	33-4
Identity Management Realms in a Hosted Deployment	33-4
Identity Management Realm Implementation in Oracle Internet Directory	33-5
Default Directory Information Tree and the Identity Management Realm	33-6
Customizing the Default Identity Management Realm	33-8
Steps to Update the Existing User and Group Search Base	33-10
Set up an Additional Search Base	33-11
Refresh Oracle Single Sign-On	33-12
Reconfigure Provisioning Profiles	33-12
Creating Additional Identity Management Realms for Hosted Deployments	33-14

34 Tuning and Sizing Oracle Internet Directory

35 Managing Garbage Collection

Introduction to Managing Garbage Collection	35-1
Components of the Oracle Internet Directory Garbage Collection Framework.....	35-1
Garbage Collection Plug-in	35-1
Background Database Processes.....	35-2
How Oracle Internet Directory Garbage Collection Works.....	35-4
Garbage Collector Entries and the Oracle Internet Directory Statistics Collector Entry	35-5
Change Log Purging.....	35-5
Set Oracle Database Time Zone for Garbage Collection	35-6
Modifying Oracle Internet Directory Garbage Collectors	35-7
Modifying a Garbage Collector by Using Oracle Directory Services Manager	35-7
Modifying a Garbage Collector by Using Command-Line Tools	35-7
Example 1: Modifying a Garbage Collector	35-7
Example 2: Disabling a Garbage Collector Change Log	35-7
Modifying the Oracle Internet Directory Statistics Collector	35-8
Managing Logging for Oracle Internet Directory Garbage Collectors	35-8
Enabling Logging for Oracle Internet Directory Garbage Collectors.....	35-8
Disabling Logging for Oracle Internet Directory Garbage Collectors.....	35-9
Monitoring Garbage Collection Logging.....	35-9
Configuring Time-Based Change Log Purging	35-9

36 Migrating Data from Other Data Repositories

Introduction to Migrating Data from Other Data Repositories	36-1
Migrating Data from LDAP-Compliant Directories	36-1
Migrating LDAP Data by Using an LDIF File and bulkload	36-2
Migrating LDAP Data by Using syncProfileBootstrap Directly	36-4
Migrating LDAP Data by Using an LDIF File and syncProfileBootstrap	36-5
Migrating LDAP Data by Using syncProfileBootstrap, bulkload, and LDIF Files.....	36-5
Migrating LDAP Data by Using the Oracle Directory Integration Platform Server	36-6
Migrating User Data from Application-Specific Repositories	36-6
The Intermediate Template File	36-7
Reconciling Data in Application Repository with Data Already in the Directory	36-7
Tasks For Migrating Data from Application-Specific Repositories	36-7
Task 1: Create an Intermediate Template File	36-7
Task 2: Run the OID Migration Tool.....	36-9

37 Configuring Server Chaining

Introduction to Configuring Server Chaining	37-1
Supported External Servers	37-2
Integrated Oracle Products.....	37-2
Oracle Single Sign-On	37-2
Enterprise User Security	37-2
Supported Operations	37-3
Server Chaining with Replication	37-3

Configuring Server Chaining	37-3
Configuring Server Chaining by Using Oracle Directory Services Manager.....	37-4
Configuring Server Chaining from the Command Line	37-5
Creating Server Chaining Configuration Entries	37-5
Configuration Entry Attributes.....	37-6
Requirements for User and Group Containers.....	37-8
Attribute Mapping	37-8
Active Directory Example.....	37-9
Active Directory with SSL Example	37-10
Active Directory with New Attributes Example	37-11
Oracle Directory Server Enterprise Edition and Sun Java System Directory Server (iPlanet) Example	37-11
Oracle Directory Server Enterprise Edition and Sun Java System Directory Server (iPlanet) with SSL Example	37-12
eDirectory Example	37-13
eDirectory with SSL Example	37-14
Debugging Server Chaining	37-14
Configuring an Active Directory Plug-in for Password Change Notification	37-14

Part V Advanced Administration: Directory Replication

38 Setting Up Replication

Introduction to Setting Up Replication	38-2
Replication Transport Mechanisms.....	38-2
Replication Setup Methods.....	38-2
Replication Wizard	38-2
Command Line Tools	38-3
Database Copy Procedure	38-3
Bootstrap Rules.....	38-3
The Replication Agreement.....	38-4
Other Replication Configuration Attributes	38-5
Replication Process and Architecture	38-5
Rules for Configuring LDAP-Based Replication.....	38-5
Replication Security	38-6
Authentication and the Directory Replication Server	38-6
Secure Sockets Layer (SSL) and Oracle Internet Directory Replication.....	38-7
LDAP Replication Filtering for Partial Replication.....	38-7
Included and Excluded Naming Contexts in LDAP Replication Filtering	38-7
Attributes that Control Naming Contexts.....	38-8
Rules for LDAP Replication Filtering	38-8
Examples of LDAP Replication Filtering.....	38-8
Rules for Managing Naming Contexts and Attributes	38-12
Optimization of Partial Replication Naming Context for Better Performance.....	38-13
Converting an Advanced Replication-Based Agreement to an LDAP-Based Agreement ...	38-15
Setting Up an LDAP-Based Replication Agreement by Using the Replication Wizard	38-16
Testing Replication by Using Oracle Directory Services Manager	38-17
Setting Up an LDAP-Based Replication by Using the Command Line	38-17

Copying Your LDAP Data by Using Idifwrite and bulkload	38-18
Setting Up an LDAP-Based Replica with Customized Settings.....	38-18
Setting Up an LDAP-Based Replica by Using Automatic Bootstrapping	38-19
Setting Up an LDAP-Based Replica by Using the Idifwrite Tool	38-24
Password Policy and Fan-out Replication.....	38-28
Deleting an LDAP-Based Replica	38-29
Task 1: Stop the Directory Replication Server on the Node to be Deleted	38-29
Task 2: Delete the Replica from the Replication Group	38-30
Setting Up a Multimaster Replication Group with Fan-Out.....	38-30

39 Setting Up Replication Failover

Introduction to Replication Failover	39-1
Limitations and Warnings for Replication Failover.....	39-4
Determining Which Type of Replication Failover to Use	39-5
Performing a Stateless Replication Failover	39-5
Task 1: Stop all Directory Replication Server on related Nodes	39-5
Task 2: Break Old Replication Agreement and Set up New Agreement	39-6
Task 3: Save Last Change Number	39-6
Task 4: Compare and Reconcile New Supplier and Consumer	39-6
Task 5: Update Last Applied Change Number of New Agreement.....	39-6
Task 6: Clean Up Old Agreement on Old Supplier.....	39-7
Task 7: Start All Directory Replication Server on related Nodes	39-7
Performing a Time-Based Replication Failover	39-8
Task 1: Configure Change Log Garbage Collection Object on New Supplier	39-8
Task 2: Save Last Change Number from New Supplier.....	39-8
Task 3: Enable Change Log Regeneration on New Supplier	39-8
Task 4: Wait for the Desired Time Period to Elapse.....	39-9
Task 5: Stop all Directory Replication Servers on Related Nodes.....	39-9
Task 6: Break Old Replication Agreement and Set Up New Agreement	39-9
Task 7: Update Last Applied Change Number of New Agreement.....	39-9
Task 8: Clean Up Old Agreement on Old Supplier.....	39-9
Task 9: Start All Directory Replication Servers on Related Nodes	39-10

40 Managing Replication Configuration Attributes

Introduction to Replication Configuration Attributes	40-1
The Replication Configuration Container	40-1
The Replica Subentry	40-2
The Replication Agreement Entry	40-3
Replication Agreement Entry Attributes.....	40-3
Oracle Database Advanced Replication-Based Replication Agreements.....	40-5
LDAP Replication Agreements.....	40-5
Two-Way LDAP Replication Agreements	40-5
The Replication Naming Context Container Entry	40-6
The Replication Naming Context Object Entry	40-6
The Replication Configuration Set.....	40-8
Examples of Replication Configuration Objects in the Directory	40-9
Configuring Replication Configuration Attributes by Using Fusion Middleware Control	40-12

Configuring Attributes on the Shared Properties, Replication Tab.....	40-12
Configuring Replication Wizard Parameters.....	40-13
Managing Replication Configuration Attributes From the Command Line.....	40-14

41 Managing and Monitoring Replication

Introduction to Managing and Monitoring Replication	41-1
Modifying What Is to Be Replicated in LDAP-Based Partial Replication	41-2
Managing Worker Threads.....	41-2
Change Logs in Directory Replication	41-3
The Human Intervention Queue	41-3
Managing the Queues	41-3
Queue Statistics	41-4
The Number of Entries the Human Intervention Queue Tools Can Process.....	41-4
Pilot Mode	41-4
Conflict Resolution in Oracle Replication	41-4
Levels at Which Replication Conflicts Occur.....	41-5
Automatic Conflict Resolution.....	41-6
How Automated Conflict Resolution Works.....	41-6
Managing and Monitoring Replication by Using ODSM and Fusion Middleware Control.	41-7
Enabling or Disabling Change Log Generation by Using Fusion Middleware Control	41-7
Viewing the Local Change Logs by Using Oracle Directory Services Manager.....	41-8
Viewing and Modifying Replica Naming Context Objects	41-8
Viewing or Modifying a Replication Setup by Using the Replication Wizard	41-9
Deleting an LDAP-Based Replication Agreement by Using the Replication Wizard	41-10
Configure Replication Attributes by Using Fusion Middleware Control	41-11
Activating or Inactivating a Replication Server by Using Fusion Middleware Control	41-11
Configuring the Replication Debug Level by Using Fusion Middleware Control	41-12
Configuring Replica Details by Using Fusion Middleware Control	41-12
Viewing Queue Statistics by Using Fusion Middleware Control.....	41-13
Managing Changelog Processing by Using Fusion Middleware Control	41-13
Monitoring Conflict Resolution Messages by Using Fusion Middleware Control	41-14
Managing and Monitoring Replication by Using the Command Line	41-14
Enabling and Disabling Change Log Generation by Using the Command Line.....	41-15
Viewing Change Logs by Using ldapsearch	41-15
Configuring Attributes of the Replica Subentry by Using ldapmodify	41-16
Specifying Pilot Mode for a Replica by Using remtool	41-17
Configuring Replication Agreement Attributes by Using ldapmodify	41-17
Modifying Replica Naming Context Object Parameters by Using ldapmodify	41-18
Configuring Attributes of the Replication Configuration Set by Using ldapmodify.....	41-21
Monitoring Conflict Resolution Messages by Using the Command Line	41-22
Managing the Human Intervention Queue	41-24
Viewing Queue Statistics and Verifying Replication by Using remtool	41-24
Managing the Number of Entries the Human Intervention Queue Tools Can Process	41-25
Changing the Replication Administrator's Password for Advanced Replication.....	41-26
Comparing and Reconciling Inconsistent Data by Using oidcmprec.....	41-26
Conflict Scenarios.....	41-27
Operations Supported by oidcmprec.....	41-28

Output from oidcmprec	41-28
How oidcmprec Works	41-29
Setting the Source and Destination Directories	41-30
Selecting the DIT for the Operation.....	41-30
Selecting the Attributes for the Operation.....	41-31
Controlling Change Log Generation	41-31
Using a Text or XML Parameter File	41-32
Including Directory Schema	41-33
Overriding Predefined Conflict Resolution Rules	41-33
Using the User-Defined Compare and Reconcile Operation.....	41-33
Known Limitations of the oidcmprec Tool	41-34

Part VI Advanced Administration: Directory Plug-ins

42 Configuring a Customized Password Policy Plug-In

Introduction to Configuring a Customized Password Policy Plug-in	42-1
Installing, Configuring, and Enabling a Customized Password Policy Plug-in	42-2
Loading and Registering the PL/SQL Program.....	42-2
Coding the Password Policy Plug-in.....	42-3
Debugging the Password Policy Plug-in.....	42-3
Contents of Sample PL/SQL Package pluginpkg.sql.....	42-4

43 Developing Plug-ins for the Oracle Internet Directory Server

Introduction to Developing Plug-ins for the Oracle Internet Directory Server	43-1
Supported Languages for Server Plug-ins.....	43-2
Server Plug-in Prerequisites	43-2
Server Plug-in Benefits	43-3
Guidelines for Designing Plug-ins	43-3
The Server Plug-in Framework.....	43-3
LDAP Operations and Timings Supported by the Directory	43-4
Pre-Operation Server Plug-ins	43-4
Post-Operation Server Plug-ins	43-4
When-Operation Server Plug-ins	43-4
When_Replace-Operation Server Plug-ins.....	43-5
Using Plug-ins in a Replication Environment	43-5
Creating a Plug-in.....	43-5
Registering a Plug-in From the Command Line.....	43-6
Creating a Plug-in Configuration Entry	43-6
Adding a Plug-in Configuration Entry by Using Command-Line Tools	43-8
Managing Plug-ins by Using Oracle Directory Services Manager.....	43-9
Creating a New Plug-in by Using Oracle Directory Services Manager	43-9
Registering a Plug-in by Using Oracle Directory Services Manager.....	43-9
Editing a Plug-in by Using Oracle Directory Services Manager	43-10
Deleting a Plug-in by Using Oracle Directory Services Manager.....	43-10

44 Configuring a Customized External Authentication Plug-in

Introduction to Configuring a Customized External Authentication Plug-in	44-1
Installing, Configuring, and Enabling the External Authentication Plug-in	44-1
Debugging the External Authentication Plug-in	44-3
Creating the PL/SQL Package oidexaup.sql.....	44-3

Part VII Appendixes

A Differences Between 10g and 11g

Instance Creation and Process Management	A-1
Locations of Configuration Attributes	A-3
Default Ports.....	A-5
Enabling Server Debugging.....	A-6
Command Line Tools.....	A-6
Path Names	A-7
Graphical User Interfaces	A-7
Audit	A-7
Referential Integrity	A-8
Server Chaining.....	A-8
Replication.....	A-8
Oracle Directory Integration Platform	A-8
Oracle Single Sign-On and Oracle Delegated Administration Services.....	A-8
Java Containers	A-9

B Managing Oracle Internet Directory Instances by Using OIDCTL

Introduction to Managing Oracle Internet Directory by Using OIDCTL.....	B-1
Creating and Starting an Oracle Internet Directory Server Instance by Using OIDCTL	B-3
Stopping an Oracle Internet Directory Server Instance by Using OIDCTL.....	B-3
Starting an Oracle Internet Directory Server Instance by Using OIDCTL.....	B-4
Viewing Status Information by Using OIDCTL.....	B-4
Deleting an Oracle Internet Directory Server Instance by Using OIDCTL.....	B-4

C Setting Up Oracle Database Advanced Replication-Based Replication

Introduction to Setting up Oracle Database Advanced Replication-Based Replication	C-1
Database Version Compatibility	C-1
Advanced Replication Filtering for Partial Replication	C-1
Excluded Naming Contexts.....	C-1
Rules for Advanced Replication Filtering.	C-2
Setting Up Advanced Replication-Based Replication	C-2
Rules for Setting Up Advanced Replication.....	C-3
Setting Up an Advanced Replication-Based Multimaster Replication Group.....	C-4
Task 1: Install Oracle Internet Directory on the Master Definition Site (MDS)	C-4
Task 2: Install the Oracle Internet Directory on the Remote Master Sites (RMS).....	C-5
Task 3: Set Up Advanced Replication for a Directory Replication Group	C-6
Task 4 (Optional): Load Data into the Directory	C-9

Task 5: Ensure that Oracle Directory Server Instances are Started on All the Nodes ...	C-10
Task 6: Start the Replication Servers on All Nodes in the DRG.....	C-10
Task 7: Test Directory Replication.....	C-10
Adding a Node for Advanced Replication-Based Multimaster Replication.....	C-11
Prepare the Oracle Net Services Environment	C-11
Task 1: Stop the Directory Replication Server on All Nodes.....	C-12
Task 2: Identify a Sponsor Node and Install Oracle Internet Directory	C-12
Task 3: Switch the Sponsor Node to Read-Only Mode	C-12
Task 4: Back up the Sponsor Node by Using Idifwrit.....	C-12
Task 5: Perform Advanced Replication Add Node Setup	C-12
Task 6: Switch the Sponsor Node to Updatable Mode.....	C-13
Task 7: Start the Directory Replication Server on All Nodes Except the New Node.....	C-13
Task 8: Load Data into the New Node by Using bulkload.....	C-14
Task 9: Start the Directory Server on the New Node.....	C-14
Task 10: Start the Directory Replication Server on the New Node.....	C-14
Deleting a Node from a Multimaster Replication Group.....	C-14
Task 1: Stop the Directory Replication Server on All Nodes.....	C-15
Task 2: Stop All Oracle Internet Directory Processes in the Node to be Deleted	C-15
Task 3: Delete the Node from the Master Definition Site	C-15
Task 4: Start the Directory Replication Server on All Nodes	C-15

D How Replication Works

Features of Oracle Database Advanced Replication-Based Replication	D-1
Architecture for Oracle Database Advanced Replication-Based Replication	D-2
Architecture of LDAP-Based Replication.....	D-4
LDAP Replica States.....	D-5
The Replication Process	D-8
How the Multimaster Replication Process Adds a New Entry to a Consumer.....	D-8
How the Multimaster Replication Process Deletes an Entry.....	D-9
How the Multimaster Replication Process Modifies an Entry	D-9
How the Multimaster Replication Process Modifies a Relative Distinguished Name	D-10
How the Multimaster Replication Process Modifies a Distinguished Name.....	D-11

E Java Server Plug-in Developer's Reference

Advantages of Java Plug-ins	E-1
Setting Up a Java Plug-in.....	E-1
Java Plug-in API	E-2
Communication Between the Server and Plug-in	E-3
Java Plug-in Structure.....	E-3
PluginDetail	E-4
Server	E-4
LdapBaseEntry	E-4
LdapOperation	E-5
PluginFlexfield	E-10
PluginResult.....	E-11
ServerPlugin Interface	E-11
ServerPlugin Methods for Ldapbind	E-11

ServerPlugin Methods for Ldapcompare	E-12
ServerPlugin Methods for Ldapadd	E-12
ServerPlugin Methods for Ldapmodify	E-12
ServerPlugin Methods for Ldapmoddn	E-12
ServerPlugin Methods for Ldapsearch	E-12
ServerPlugin Methods for Ldapdelete	E-12
Java Plug-in Error and Exception Handling	E-12
Run-time Exception Example	E-13
Run-time Error Example	E-13
PluginException Example	E-13
Java Plug-in Debugging and Logging	E-13
Java Plug-in Examples	E-14
Example 1: Password Validation Plug-in	E-14
Password Validation Plug-in Configuration Entry	E-15
Password Validation Plug-in Code Example	E-15
Example 2: External Authentication Plug-in for Active Directory	E-16
External Authentication Plug-in Configuration Entry	E-16
External Authentication Plug-in Code	E-16

F PL/SQL Server Plug-in Developer's Reference

Designing, Creating, and Using PL/SQL Server Plug-ins	F-1
PL/SQLPlug-in Caveats	F-1
Types of PL/SQL Plug-in Operations	F-2
Naming PL/SQL Plug-ins	F-2
Creating PL/SQLPlug-ins	F-2
Package Specifications for Plug-in Module Interfaces	F-2
Compiling PL/SQLPlug-ins	F-4
Dependencies	F-4
Recompiling Plug-ins	F-4
Managing PL/SQL Plug-ins	F-4
Modifying Plug-ins	F-4
Debugging Plug-ins	F-4
Enabling and Disabling PL/SQL Plug-ins	F-5
Exception Handling in a PL/SQL Plug-in	F-5
Error Handling	F-5
Program Control Handling between Oracle Internet Directory and Plug-ins	F-5
PL/SQL Plug-in LDAP API	F-6
PL/SQL Plug-in and Database Tools	F-6
PL/SQL Plug-in Security	F-6
PL/SQL Plug-in Debugging	F-7
PL/SQL Plug-in LDAP API Specifications	F-7
Database Limitations	F-8
Examples of PL/SQL Plug-ins	F-8
Example 1: Search Query Logging	F-8
Example 2: Synchronizing Two DITs	F-10
Binary Support in the PL/SQLPlug-in Framework	F-12
Binary Operations with ldapmodify	F-12

Binary Operations with ldapadd	F-14
Binary Operations with ldapcompare.....	F-16
Database Object Types Defined	F-20
Specifications for PL/SQL Plug-in Procedures.....	F-21

G The LDAP Filter Definition

H The Access Control Directive Format

Schema for orclACI.....	H-1
Schema for orclEntryLevelACI.....	H-2

I Globalization Support in the Directory

About Character Sets and the Directory	I-1
About Unicode.....	I-2
About Oracle and UTF-8	I-2
Migration from UTF8 to AL32UTF8 when Upgrading Oracle Internet Directory	I-2
The NLS_LANG Environment Variable	I-3
Using Non-AL32UTF8 Databases	I-4
Using Globalization Support with LDIF Files	I-4
An LDIF file Containing Only ASCII Strings.....	I-4
An LDIF file Containing UTF-8 Encoded Strings.....	I-4
CASE 1: Native Strings (Non-UTF-8).....	I-5
CASE 2: UTF-8 Strings	I-5
CASE 3: BASE64 Encoded UTF-8 Strings.....	I-5
CASE 4: BASE64 Encoded Native Strings	I-5
Using Globalization Support with Command-Line LDAP Tools	I-5
Specifying the -E Argument When Using Each Tool.....	I-6
Examples: Using the -E Argument with Command-Line LDAP Tools	I-6
Setting NLS_LANG in the Client Environment	I-7
Using Globalization Support with Bulk Tools	I-8
Using Globalization Support with bulkload.....	I-8
Using Globalization Support with ldifwrite	I-8
Using Globalization Support with bulkdelete	I-8
Using Globalization Support with bulkmodify	I-9

J Setting up Access Controls for Creation and Search Bases for Users and Groups

Setting up Access Controls for the User Search Base and the User Creation Base	J-1
Setting up Access Controls for the Group Search Base and the Group Creation Base	J-3

K Searching the Directory for User Certificates

Certificate Mapping.....	K-1
Search Types.....	K-2

L	Adding a Directory Node by Using the Database Copy Procedure	
	Definitions.....	L-1
	Prerequisites.....	L-1
	Sponsor Directory Site Environment.....	L-2
	New Directory Site Environment.....	L-2
	Addition of a Directory Node.....	L-2
M	Oracle Authentication Services for Operating Systems	
N	RFCs Supported by Oracle Internet Directory	
O	Managing Oracle Directory Services Manager's Java Key Store	
	Introduction to Managing ODSM's Java Key Store.....	O-1
	Retrieving ODSM's Java Key Store Password.....	O-2
	Listing the Contents of odsm.cer Java Key Store.....	O-2
	Deleting Expired Certificates.....	O-3
	Determining the Expiration Date of a Certificate.....	O-4
	Deleting a Certificate.....	O-4
P	Starting and Stopping the Oracle Stack	
	Starting the Stack.....	P-1
	Stopping the Stack.....	P-2
Q	Performing a Rolling Upgrade	
	Prerequisites for Rolling Upgrade.....	Q-1
	Rolling Upgrade Instructions.....	Q-1
	Rolling Upgrade Example.....	Q-3
R	Troubleshooting Oracle Internet Directory	
	Problems and Solutions.....	R-1
	Installation Errors.....	R-2
	Oracle Database Server Errors.....	R-2
	Oracle Database Server Connection is Down.....	R-2
	Oracle Database Server Error Due to Interrupted Client Connection.....	R-2
	Oracle Database Server Error Due to Schema Modifications.....	R-3
	Directory Server Error Messages and Causes.....	R-3
	Inappropriate Authentication Error.....	R-3
	Constraint Violation Error Due to Editing a User or Group or Creating a Realm.....	R-3
	Standard Error Messages Returned from Oracle Directory Server.....	R-4
	Additional Directory Server Error Messages.....	R-5
	Getting a Core Dump and Stack Trace When Oracle Internet Directory Crashes.....	R-8
	TCP/IP Problems.....	R-8
	Do Not Use TCP-Based Monitoring of Server Availability on Windows 2003 Server....	R-9
	Do Not Install DaimondCS Port Explorer.....	R-9
	Troubleshooting Password Policies.....	R-9

Password Policy is Not Enforced.....	R-9
Password Policy Error Messages.....	R-9
Troubleshooting Directory Performance.....	R-10
Poor LDAP Search Performance.....	R-10
Poor LDAP Add or Modify Performance.....	R-11
Poor Oracle Database Server Performance	R-11
Troubleshooting Port Configuration.....	R-12
Troubleshooting Creating Oracle Internet Directory Component with opmnctl.....	R-12
Troubleshooting Starting Oracle Internet Directory	R-12
Oracle Internet Directory is Down	R-13
Oracle Internet Directory is Read-Only	R-14
Troubleshooting Starting, Stopping, and Restarting of the Directory Server	R-14
About the Tools for Starting, Stopping, and Restarting the Directory Server Instance	R-14
Problems Starting, Stopping, and Restarting the Directory Server	R-16
Troubleshooting Oracle Internet Directory Replication.....	R-18
Replication Server Does Not Start	R-19
Repository Creation Assistant Error	R-20
Errors in Replication Bootstrap.....	R-21
Changes Are Not Replicated	R-22
Replication Stops Working	R-23
Troubleshooting Change Log Garbage Collection.....	R-24
Troubleshooting Dynamic Password Verifiers.....	R-25
Troubleshooting Oracle Internet Directory Password Wallets	R-25
Oracle Internet Directory Server Does Not Start.....	R-25
Password Not Synchronized	R-26
Troubleshooting bulkload.....	R-26
Troubleshooting bulkdelete, bulkmodify, and ldifwrite.....	R-28
Troubleshooting catalog.....	R-28
Troubleshooting remtool	R-28
Troubleshooting Server Chaining.....	R-29
Viewing Version Information.....	R-29
Troubleshooting Fusion Middleware Control and WLST	R-29
Troubleshooting Oracle Directory Services Manager.....	R-30
Cannot Invoke ODSM from Fusion Middleware Control	R-30
Cannot Invoke ODSM from Fusion Middleware Control in Multiple NIC and DHCP Enabled Environment	R-31
Various Failover Issues	R-31
ODSM Displays an Error Message	R-32
Cursor Loses Focus.....	R-33
Need More Help?	R-33

Index

List of Figures

1-1	Oracle Internet Directory Overview	1-5
3-1	A Typical Oracle Internet Directory Node	3-2
3-2	Oracle Directory Server Instance Architecture	3-4
3-3	A Directory Information Tree	3-7
3-4	Attributes of the Entry for Anne Smith	3-9
3-5	Correct and Incorrect Naming Contexts	3-14
3-6	A Partitioned Directory	3-17
3-7	Using Knowledge References to Point to Naming Contexts	3-18
3-8	Placement of Resource Access and Resource Type Information in the DIT	3-25
4-1	Oracle Internet Directory Process Control	4-2
5-1	Planning the Directory Information Tree	5-2
6-1	A Replicated Directory	6-1
6-2	Example of Partial Replication	6-3
6-3	Example of Single-Master Replication	6-5
6-4	Example of Multimaster Replication	6-5
6-5	Example of Fan-Out Replication	6-6
6-6	Example of Multimaster Replication with Fan-Out	6-8
8-1	DIT Showing Two Instance-Specific Configuration Entries	8-2
8-2	Oracle Internet Directory Process Control	8-3
17-1	Alias Entries Example	17-2
17-2	Resulting Tree when Creating the My_file.ldif	17-3
18-1	Example of a Directory Information Tree	18-4
20-1	Location of Schema Components in Entries of Type subSchemaSubentry	20-2
24-1	Architecture of Oracle Internet Directory Server Manageability	24-3
28-1	Location of Password Policy Entries	28-3
28-2	pwdPolicy subentry Attributes Populated with DN of Password Policy	28-3
30-1	Location of the Password Verifier Profile Entry	30-5
30-2	Authentication Model	30-7
30-3	How Password Verification Works	30-9
31-1	Delegation Flow in an Oracle Fusion Middleware Environment	31-2
32-1	Indirect Authentication	32-3
33-1	Example of an Identity Management Realm	33-3
33-2	Enterprise Use Case: Single Identity Management Realm	33-4
33-3	Enterprise Use Case: Multiple Identity Management Realms	33-4
33-4	Hosted Deployment Use Case	33-5
33-5	Default Identity Management Realm	33-6
35-1	Example: Garbage Collection of Change Log Entries	35-4
35-2	Garbage Collection Entries in the DIT	35-5
36-1	Using an LDIF File and bulkload	36-2
36-2	Using syncProfileBootstrap Directly	36-5
36-3	Using an LDIF File and syncProfileBootstrap	36-5
36-4	Using syncProfileBootstrap, bulkload, and LDIF Files	36-6
36-5	Using the Oracle Directory Integration Server	36-6
36-6	Structure of the Intermediate User File	36-8
38-1	A Sample Naming Context	38-8
38-2	Naming Context Object #1	38-9
38-3	Naming Context Object #2	38-10
38-4	Result of Combining Naming Context Objects #1 and #2	38-10
38-5	Naming Context Object #3	38-11
38-6	Naming Context Object #4	38-11
38-7	Result of Combining Naming Context Objects #3 and #4	38-12
38-8	Naming Context Object #5	38-14
38-9	Naming Context Object #6	38-14
38-10	Naming Context Object #7	38-15

38-11	Example of Fan-Out Replication.....	38-31
39-1	Replication Failover Scenario.....	39-2
39-2	Consumer and New Supplier Connected to Old Supplier by LDAP.....	39-3
39-3	Old and New Suppliers in the Same Advanced Replication Group.....	39-3
39-4	Failover Preserving Replica Type.....	39-4
39-5	Compare and Reconcile All Connected Replicas	39-5
40-1	Example: Multimaster Replication and Fan-Out Replication	40-10
40-2	Example: Replication Configuration Entries for Node C.....	40-11
40-3	Example: Replication Configuration Entries for Node D	40-12
43-1	Oracle Internet Directory Plug-in Framework	43-2
B-1	A Component with Two Instances.....	B-2
C-1	Example of a Naming Context Container and Its Objects	C-2
D-1	Advanced Replication Process.....	D-2
D-2	LDAP Replication Process	D-4
E-1	Communication Between the Server and the Java Plug-in.....	E-3

List of Tables

1-1	Comparison of Online Directories and Relational Databases	1-2
3-1	An Oracle Internet Directory Node.....	3-3
3-2	Attributes Created with Each New Entry	3-10
3-3	Common LDAP Attributes.....	3-10
4-1	Process Control Items in the ODS_PROCESS_STATUS Table.....	4-3
6-1	Full or Partial Replication	6-3
6-2	Direction of Replication	6-3
6-3	Transport Protocols	6-4
6-4	Types of Directory Replication Groups	6-4
6-5	Types of Data Transfer Between Nodes in a Directory Replication Group	6-7
7-1	Using the Oracle Internet Directory Menu.....	7-4
8-1	Attribute Changes Requiring Update of Component Registration.....	8-8
9-1	Attributes of the Instance-Specific Configuration Entry	9-3
9-2	Attributes in the DSA Configuration Entry	9-9
9-3	Attributes of the DSE.....	9-11
9-4	Configuration Attributes on Server Properties Page, General Tab.	9-12
9-5	Configuration Attributes on Server Properties Page, Performance Tab.....	9-12
9-6	Configuration Attributes on Shared Properties Page, General Tab	9-13
9-7	Oracle Internet Directory-Related MBeans	9-15
12-1	Configuration Attributes on Shared Properties, Change Superuser Password Tab....	12-5
14-1	orclDynamicGroup Attributes for "Connect By" Assertions.....	14-5
14-2	Static and Dynamic Group Considerations	14-8
17-1	Flags for Searching the Directory with Alias Entries.....	17-3
17-2	Entry Alias Dereferencing Messages	17-6
18-1	Attribute Uniqueness Constraint Entry.....	18-2
20-1	Attribute Aliases Used in Examples.....	20-23
20-2	Content Rule Parameters	20-26
22-1	Oracle Internet Directory Audit Configuration Attributes.....	22-2
22-2	Audit Configuration Attributes in Fusion Middleware Control	22-4
23-1	Oracle Internet Directory Log File Locations.....	23-1
23-2	Configuration Attributes on Server Properties Page, Logging Tab	23-5
23-3	Values for OrclDebugFlag	23-7
23-4	Debug Operations	23-7
24-1	Components of Oracle Internet Directory Server Manageability	24-3
24-2	Configuration Attributes on Server Properties Page, Statistics Tab.....	24-5
24-3	Values of orcloptracklevel	24-8
24-4	Metrics Recorded by Each orcloptracklevel Value	24-9
24-5	Event Levels.....	24-9
26-1	SSL Cipher Suites Supported in Oracle Internet Directory	26-2
26-2	SSL Authentication Modes	26-3
26-3	SSL-Related Attributes in Fusion Middleware Control	26-8
26-4	SSL Attributes.....	26-11
27-1	Sensitive Attributes Stored in orclencryptedattributes	27-6
27-2	LDAP and Bulk Operations on Attributes in orclhashedattributes	27-7
28-1	Password Policy Attributes	28-5
28-2	Password Policy-Related Operational Attributes	28-7
29-1	Sample Security Groups.....	29-6
29-2	Types of Access	29-10
29-3	LDAP Operations and Access Needed to Perform Each One	29-11
29-4	Attribute States During ACL Evaluation	29-12
29-5	DNs Used in Example	29-25
30-1	Attributes for Storing Password Verifiers in User Entries.....	30-5
31-1	Default Privileges Granted to Everyone and to Each User.....	31-3

31-2	Privileges for Administering the Oracle Technology Stack.....	31-4
31-3	Characteristics of the Subscriber DAS Create User Group.....	31-5
31-4	Characteristics of the Subscriber DAS Edit User Group.....	31-6
31-5	Characteristics of the DAS Delete User Group.....	31-6
31-6	Characteristics of the User Privilege Assignment Group.....	31-6
31-7	Characteristics of the Group Creation Group.....	31-7
31-8	Characteristics of the Group Edit Group.....	31-7
31-9	Characteristics of the Group Delete Group.....	31-8
31-10	Characteristics of the Group Privilege Assignment Group.....	31-8
31-11	Characteristics of the Oracle Application Server Administrators Group.....	31-9
31-12	Characteristics of the User Management Application Administrators Group.....	31-10
31-13	Characteristics of the Trusted Application Administrators Group.....	31-10
31-14	Characteristics of the User Security Administrators Group.....	31-12
31-15	Characteristics of the Authentication Services Group.....	31-12
31-16	Characteristics of the Verifier Services Group.....	31-12
31-17	Characteristics of the User Proxy Privilege Group.....	31-13
31-18	Characteristics of the Oracle Context Administrators Group.....	31-13
31-19	Characteristics of the Common User Attributes Group.....	31-14
31-20	Characteristics of the Common Group Attributes Group.....	31-14
31-21	Characteristics of the Service Registry Viewers Group.....	31-14
31-22	Characteristics of the Common Group Attributes Group.....	31-14
32-1	Configuration Attributes on Server Properties, SASL Tab.....	32-6
32-2	SASL Authentication Attributes.....	32-7
32-3	SASL Authentication Modes.....	32-7
32-4	Orclanonymousofbindsflag Value and Directory Server Behavior.....	32-8
33-1	Oracle Identity Management Objects.....	33-5
33-2	Customizing the Default Identity Management Realm.....	33-8
36-1	Features of bulkload and syncProfileBootstrap.....	36-2
36-2	Mandatory Attributes in a User Entry.....	36-9
37-1	Configuration Entry Attributes for Server Chaining.....	37-6
37-2	Default Attribute Mapping to Active Directory.....	37-8
37-3	Default Attribute Mapping to Sun Java System Directory Server.....	37-9
37-4	Default Attribute Mapping to Novell eDirectory.....	37-9
38-1	Data Migration Using Idifwrite/bulkload versus Automatic Bootstrapping.....	38-18
38-2	Command-line Parameters to OIDUpgradePasswordPolicies.....	38-29
38-3	Nodes in Example of Partial Replication Deployment.....	38-30
40-1	Attributes of the Replica Subentry.....	40-2
40-2	Attributes of the Replication Agreement Entry.....	40-3
40-3	Attributes of the Replication Naming Context Entry.....	40-7
40-4	Replication Configuration Set Attributes.....	40-8
40-5	Configuration Attributes on Shared Properties, Replication Tab.....	40-13
40-6	Replication Schedule Attributes.....	40-13
41-1	Configuration Attributes Controlling Worker Threads.....	41-2
41-2	Types of Replication Conflict.....	41-5
41-3	Properties on the Change Log Page.....	41-8
41-4	Replication Configset Attributes on Shared Properties, Replication Tab.....	41-11
41-5	Replication Server Status Attributes on Shared Properties, Replication Tab.....	41-12
41-6	Replica Details on Shared Properties, Replication Tab.....	41-13
41-7	Important Attributes in the Change Log.....	41-16
41-8	Replica Subentry Attributes.....	41-16
41-9	Replication Agreement Options.....	41-17
41-10	Replication Configuration Attributes.....	41-21
41-11	Replication Debug Levels.....	41-22
41-12	Conflict Resolution Messages.....	41-23
43-1	Plug-in Configuration Objects and Attributes.....	43-6

A-1	New Locations of 10g Attributes	A-4
A-2	Some Path Names that Changed	A-7
D-1	LDAP Replica States	D-6
E-1	Plug-in Names and Corresponding Paths.....	E-2
E-2	The Meaning of the DN Information for Each LDAP Operation.....	E-5
E-3	Behavior of Operation Result Code.....	E-5
E-4	Subclasses of LdapOperation and Class-specific information.	E-6
E-5	Behavior of LdapEntry Information for Each Plug-in Timing	E-6
E-6	Behavior of the AttributeName for Each Plug-in Timing.....	E-7
E-7	Behavior of the Attribute Value for Each Plug-in Timing	E-7
E-8	Behavior of the Delete DN for Each Plug-in Timing	E-8
E-9	Behavior of New Parent DN Information for Each Plug-in Timing.....	E-8
E-10	Behavior of New Relative Dn Information for Each Plug-in Timing.....	E-8
E-11	Behavior of Delete Old RDN Information for Each Plug-in Timing	E-9
E-12	Behavior of LdapModification Information for Each Plug-in Timing	E-9
E-13	Behavior of the Required Attributes for Each Plug-in Timing.....	E-9
E-14	Behavior of the Scope for Each Plug-in Timing.....	E-10
E-15	Behavior of the SearchResultSet for Each Plug-in Timing.....	E-10
E-16	Debug Levels for Java Plug-in Logging.....	E-14
F-1	Plug-in Module Interface	F-2
F-2	Operation-Based and Attribute-Based Plug-in Procedure Signatures.....	F-2
F-3	Valid Values for the plug-in Return Code	F-5
F-4	Program Control Handling when a Plug-in Exception Occurs	F-5
F-5	Program Control Handling when an LDAP Operation Fails.....	F-6
I-1	Unicode Implementations	I-2
I-2	Components of the NLS_LANG Parameter.....	I-3
I-3	Examples: Using the -E Argument with Command-Line Tools	I-7
N-1	Supported RFCs	N-1
R-1	Standard Error Messages	R-4
R-2	Additional Error Messages	R-6
R-3	Password Policy Violation Error Messages.....	R-9
R-4	Error Messages for Dynamic Password Verifiers	R-25

Preface

Welcome to *Oracle Fusion Middleware Administrator's Guide for Oracle Internet Directory*.

Audience

This document is intended for anyone who performs administration tasks for the Oracle Internet Directory. You should be familiar with either the UNIX operating system or the Microsoft Windows operating system to understand the line-mode commands and examples. You can perform all of the tasks through the line-mode commands, and you can perform most of the tasks through Oracle Directory Services Manager and Oracle Enterprise Manager, which are operating system-independent.

To use this document, you need some familiarity with the Lightweight Directory Access Protocol (LDAP).

Documentation Accessibility

Our goal is to make Oracle products, services, and supporting documentation accessible to all users, including users that are disabled. To that end, our documentation includes features that make information available to users of assistive technology. This documentation is available in HTML format, and contains markup to facilitate access by the disabled community. Accessibility standards will continue to evolve over time, and Oracle is actively engaged with other market-leading technology vendors to address technical obstacles so that our documentation can be accessible to all of our customers. For more information, visit the Oracle Accessibility Program Web site at <http://www.oracle.com/accessibility/>.

Accessibility of Code Examples in Documentation

Screen readers may not always correctly read the code examples in this document. The conventions for writing code require that closing braces should appear on an otherwise empty line; however, some screen readers may not always read a line of text that consists solely of a bracket or brace.

Accessibility of Links to External Web Sites in Documentation

This documentation may contain links to Web sites of other companies or organizations that Oracle does not own or control. Oracle neither evaluates nor makes any representations regarding the accessibility of these Web sites.

Access to Oracle Support

Oracle customers have access to electronic support through My Oracle Support. For information, visit <http://www.oracle.com/support/contact.html> or visit

<http://www.oracle.com/accessibility/support.html> if you are hearing impaired.

Related Documents

For more information, see the following documents:

- Online help available through Oracle Directory Services Manager and Oracle Fusion Middleware
- The Oracle Fusion Middleware and Oracle Database documentation sets, especially:
 - *Oracle Fusion Middleware Installation Guide for Oracle Identity Management*
 - *Oracle Fusion Middleware Getting Started with Oracle Identity Management*
 - *Oracle Fusion Middleware Reference for Oracle Identity Management*
 - *Oracle Fusion Middleware Administrator's Guide for Oracle Directory Integration Platform*
 - *Oracle Fusion Middleware Administrator's Guide for Oracle Virtual Directory*
 - *Oracle Fusion Middleware Application Developer's Guide for Oracle Identity Management*
 - *Oracle Fusion Middleware High Availability Guide*
 - *Oracle Fusion Middleware Administrator's Guide*
 - *Oracle Database Administrator's Guide*
 - *Oracle Database Net Services Administrator's Guide*
 - *Oracle Real Application Clusters Administration and Deployment Guide*
 - *Oracle Database Advanced Replication*
 - *Oracle Fusion Middleware Application Security Guide*
 - *Oracle Fusion Middleware Administrator's Guide for Oracle Identity Federation*
 - *Oracle Fusion Middleware Reference for Oracle Security Developer Tools*
 - *Oracle Fusion Middleware Security Overview*

If you are using Oracle Delegated Administration Services or Oracle Single Sign-On 10g (10.1.4.3.0) or later, please refer to the following documents in the Oracle Application Server 10g (10.1.4.0.1) library:

- *Oracle Identity Management Guide to Delegated Administration*
- *Oracle Application Server Single Sign-On Administrator's Guide*

For additional information, see:

- Chadwick, David. *Understanding X.500—The Directory*. Thomson Computer Press, 1996.
- Howes, Tim and Mark Smith. *LDAP: Programming Directory-enabled Applications with Lightweight Directory Access Protocol*. Macmillan Technical Publishing, 1997.
- Howes, Tim, Mark Smith and Gordon Good, *Understanding and Deploying LDAP Directory Services*. Macmillan Technical Publishing, 1999.
- Internet Assigned Numbers Authority home page, <http://www.iana.org> for information about object identifiers

- Internet Engineering Task Force (IETF) documentation available at: <http://www.ietf.org>, especially:
 - The LDAPEXT charter and LDAP drafts
 - The LDAP charter and drafts
 - RFC 2254, "The String Representation of LDAP Search Filters"
 - RFC 1823, "The LDAP Application Program Interface"
- The OpenLDAP Community, <http://www.openldap.org>

Conventions

The following text conventions are used in this document:

Convention	Meaning
boldface	Boldface type indicates graphical user interface elements associated with an action, or terms defined in text or the glossary.
<i>italic</i>	Italic type indicates book titles, emphasis, or placeholder variables for which you supply particular values.
monospace	Monospace type indicates commands within a paragraph, URLs, code in examples, text that appears on the screen, or text that you enter.

What's New in Oracle Internet Directory?

This section provides a brief description of new features introduced with the latest releases of Oracle Internet Directory, and points you to more information about each one. It contains these topics:

- [New Features Introduced with Oracle Internet Directory 11g Release 1 \(11.1.1.4.0\)](#)
- ["New Features Introduced with Oracle Internet Directory 11g Release 1 \(11.1.1\)"](#) on page -xliii
- ["New Features Introduced with Oracle Internet Directory 10g \(10.1.4.1\)"](#) on page -xliv
- ["New Features Introduced with Oracle Internet Directory 10g Release 2 \(10.1.2\)"](#) on page -xlvi

New Features Introduced with Oracle Internet Directory 11g Release 1 (11.1.1.4.0)

- Security Enhancements
 - **AES encryption of sensitive attributes:** The algorithm for encrypting sensitive attributes is now AES. See ["Encryption Algorithm for Sensitive Attributes"](#) on page 27-6.
 - **Support for more SHA-2 variants:** Several variants of the SHA-2 hashing algorithm are now available for protecting user passwords. See [Chapter 30, "Managing Password Verifiers."](#)
 - **Account expiration based on period of inactivity:** You can now expire an account based on user inactivity. See ["Password Policy Attributes"](#) on page 28-5.
 - **Access control constrained by IP address:** You can create ACIs with constraint on the IP address of the client. See ["Bind IP Filter"](#) on page 29-9 and [Appendix H, "The Access Control Directive Format."](#)
- Oracle Directory Services Manager Capabilities
 - **SSO Integration:** You can configure ODSM to use Oracle Access Manager 11g or Oracle Access Manager 10g for single sign on. See ["Single Sign-On Integration with Oracle Directory Services Manager"](#) on page 7-6.
 - **Unlocking locked accounts:** You can list and unlock locked accounts from ODSM. See ["Listing and Unlocking Locked Accounts by Using Oracle Directory Services Manager"](#) on page 12-4.

- **Importing entries from an LDIF file and exporting entries to an LDIF file:** You can import and export from/to an LDIF file. See ["Importing Entries from an LDIF File by Using Oracle Directory Services Manager"](#) on page 13-5 and ["Exporting Entries to an LDIF File by Using Oracle Directory Services Manager"](#) on page 13-5.
- **Deleting a subtree:** You can delete an entire subtree at once. ["Deleting an Entry or Subtree by Using Oracle Directory Services Manager"](#) on page 13-8.
- **Configurable session timeout:** You can control the length of time before an inactive session times out. ["Configuring Oracle Directory Services Manager Session Timeout"](#) on page 7-12.
- LDAP Protocol Features
 - **Support for the "+" option:** You can use this option to return operational attributes on a search. See ["Listing Operational Attributes by Using ldapsearch"](#) on page 13-11.
 - **Support for collective attributes:** You can configure an attribute that is common to multiple entries. See [Chapter 16, "Managing Collective Attributes."](#)
- Groups Features
 - **Support for non-cached dynamic groups:** Dynamic lists are similar to dynamic groups, but are not cached. See ["Dynamic Groups"](#) on page 14-2.
 - **Support for OrclMemberOf attribute:** Members of some types of groups are automatically assigned a value for this attribute. See ["orclMemberOf Attribute"](#) on page 14-7
- Upgrade Requirement
 - **Rolling Upgrade of Directory Replication Groups:** If multimaster replication is configured in your existing Oracle Internet Directory environment, you must follow the procedure in [Appendix Q, "Performing a Rolling Upgrade."](#)
- Performance and Footprint Improvements
 - **Improved performance:** Performance enhancements have been made in LDAP add, LDAP search, and privilege group update.
 - **Reduced storage footprint:** Certain multi valued attributes are now stored in one row.
 - **Automatic run of oidstats.sql:** An administrator is no longer required to run `oidstats.sql` manually. OIDMON runs it, based on the number of updates in the database. See ["Updating Database Statistics by Using oidstats.sql"](#) in *Oracle Fusion Middleware Performance and Tuning Guide*.

New Features Introduced with Oracle Internet Directory 11g Release 1 (11.1.1)

- **WebLogic Server Integration:** Oracle Internet Directory in 11g Release 1 (11.1.1) is a system component that can use the WebLogic Administrative Domain for management services.

See Also:

- [Chapter 2, "Understanding Oracle Internet Directory in Oracle Fusion Middleware"](#)
- *Oracle Fusion Middleware Concepts*

- **Fusion Middleware Control:** You can manage Oracle Internet Directory by using a graphical user interface called Oracle Enterprise Manager Fusion Middleware Control

See Also: [Chapter 7, "Getting Started With Oracle Internet Directory"](#)

- **Oracle Directory Services Manager:** The old graphical user interface for managing directories, Oracle Directory Manager, has been replaced by this web-based administration tool. Use it to manage Oracle Internet Directory and Oracle Virtual Directory. You can invoke it directly or from Oracle Enterprise Manager Fusion Middleware Control.

See Also: [Chapter 7, "Getting Started With Oracle Internet Directory"](#)

- **LDAP-Based Multimaster Replication:** You can now use LDAP-based replication for multimaster directory replication groups. You no longer need Oracle Database Advanced Replication-based replication for this purpose. If you want to replicate Oracle Single Sign-On, however, you still must use Oracle Database Advanced Replication-based replication.

See Also: [Chapter 6, "Understanding Oracle Internet Directory Replication"](#)

- **Improved Replication Manageability:** You can set up and manage LDAP-based replication by using the replication wizard in Oracle Enterprise Manager Fusion Middleware Control. A separate Replication page enables you to adjust attributes that control the replication server.

See Also: [Part V, "Advanced Administration: Directory Replication"](#)

- **Sizing and Tuning Wizard:** You can obtain recommendations for tuning and sizing by running the Sizing and Tuning wizard in Oracle Enterprise Manager Fusion Middleware Control.

See Also: The Oracle Internet Directory chapter in *Oracle Fusion Middleware Performance and Tuning Guide*.

- **Integration with Common Auditing Infrastructure:** Oracle Internet Directory is now integrated with the Oracle Fusion Middleware common audit framework. You can configure auditing from the command line or by using Oracle Enterprise Manager Fusion Middleware Control.

See Also: [Chapter 22, "Managing Auditing"](#)

- **Improvements to Referential Integrity:** Referential Integrity has been completely reimplemented. You can configure it from the command line or by using Oracle Enterprise Manager Fusion Middleware Control.

See Also: [Chapter 21, "Configuring Referential Integrity"](#)

- **Updates to Password Policy Controls and Error Messages:** New controls and error messages were added to the LDAP API.

See Also:

- "Password Policies" in the "Extensions to the LDAP Protocol" chapter in *Oracle Fusion Middleware Application Developer's Guide for Oracle Identity Management*
- [Chapter 28, "Managing Password Policies"](#)

- **Configuration Parameter Changes:** Most configuration attributes for the LDAP server now reside in two entries. Instance-specific attributes are in the instance-specific configuration entry and shared attributes are in the DSA Configuration entry. You can manage most of these from the command line or by using Oracle Enterprise Manager Fusion Middleware Control or Oracle Directory Services Manager.

See Also: [Chapter 9, "Managing System Configuration Attributes"](#)

- **Improvements to Attribute and Entry Alias Support:** Oracle Internet Directory now supports several different options for dereferencing aliases in a search.

See Also: [Chapter 17, "Managing Alias Entries"](#)

- **Extensible Matching in Search Filters:** Oracle Internet Directory now supports search filters of the form: `attr:dn:=value`. With this filter, `dn` attributes are considered part of the entry for search purposes. Oracle Internet Directory does not support extensible matching using matching rules specified in the filter.

While Oracle Internet Directory supports extensible filters, `ldapsearch` and the Oracle LDAP API do not. You must use a different API, such as JNDI, to use this type of filter.

See Also: "Developing Applications with Standard LDAP APIs" in *Oracle Fusion Middleware Application Developer's Guide for Oracle Identity Management*

- **Support for Oracle Single Sign-On and Oracle Delegated Administration Services 10g (10.1.4.3.0) or later:** Oracle Fusion Middleware 11g Release 1 (11.1.1) does not include Oracle Single Sign-On or Oracle Delegated Administration Services. Oracle Internet Directory 11g Release 1 (11.1.1), however, is compatible with Oracle Single Sign-On and Oracle Delegated Administration Services 10g (10.1.4.3.0) or later.

New Features Introduced with Oracle Internet Directory 10g (10.1.4.1)

- **Links to Procedural Information:** This document contains a table of links to important tasks.
- **Identity Management Grid Control Plug-in:** This new interface enables you to monitor and manage Oracle Internet Directory, Oracle Single Sign-On, Oracle Delegated Administration Services, and Oracle Directory Integration Platform, using the features of the Oracle Enterprise Manager 10g Grid Control Console.

- **Improved Bulk Tools:** The following bulk tools have been converted into C executables:

- bulkload
- bulkmodify
- bulkdelete
- catalog
- ldifwrite

Examples and descriptions in this document and in *Oracle Fusion Middleware Reference for Oracle Identity Management* have been updated to reflect the new features of these tools.

See Also:

[Chapter 15, "Performing Bulk Operations"](#)

The chapter on Oracle Internet Directory server administration tools in *Oracle Fusion Middleware Reference for Oracle Identity Management*

- **Application-Specific Schema Containers:** A product that adds schema to Oracle Internet Directory can have its own subSchemaSubentry under cn=subSchemaSubentry.

See Also: ["Introduction to Managing Directory Schema"](#) in [Chapter 20, "Managing Directory Schema"](#)

- **Support for Attribute Aliases:** You can create user-friendly aliases for attribute names.

See Also: ["Understanding Attribute Aliases"](#) in [Chapter 20, "Managing Directory Schema"](#)

- **Caching of Dynamic Groups:** Dynamic group members are computed when the dynamic group is added, and the member list is kept consistent when the dynamic group is later modified.

See Also: ["Dynamic Groups"](#) in [Chapter 14, "Managing Dynamic and Static Groups"](#)

- **Optimizing Searches for Large Group Entries:** There is an additional technique for optimizing searches by increasing the size of the entry cache instead of disabling the entry cache.

See Also: The Oracle Internet Directory chapter in *Oracle Fusion Middleware Performance and Tuning Guide*.

- **Referential Integrity:** If you enable Referential Integrity, whenever you update an entry in the directory, the server also updates other entries that refer to that entry.

See Also: [Chapter 21, "Configuring Referential Integrity"](#)

- **New Monitoring Capabilities for Server Manageability:** You can enable additional health statistics, user statistics, and security events tracking.

See Also: [Chapter 24, "Monitoring Oracle Internet Directory"](#)

- **New Password Policy Features:** You can apply a password policy to any subtree, or even a single entry. There are also more password policy attributes to choose from.

See Also: [Chapter 28, "Managing Password Policies"](#)

- **Server Chaining:** This feature enables you to map entries that reside in third party LDAP directories to part of the directory tree and access them through Oracle Internet Directory, without synchronization or data migration.

See Also: [Chapter 37, "Configuring Server Chaining"](#)

- **Paging and Sorting of LDAP Search Results:** The `ldapsearch` command now has a `-T` option for sorting and a `-j` option for paging.

See Also:

The `ldapsearch` command-line reference in *Oracle Fusion Middleware Reference for Oracle Identity Management*

The chapter on extensions to the LDAP protocol in *Oracle Fusion Middleware Application Developer's Guide for Oracle Identity Management*

- **New Replication Features:** Oracle Internet Directory Replication has been enhanced with the following features:
 - **Two-way LDAP-Based Replication:** This feature enables you to deploy fan-out replication groups where replication flows in both directions and updates at any node are replicated to the whole group.
 - **Replication Failover:** Failover of LDAP replicas from one supplier to another is supported, with administrator intervention.
 - **Oracle Internet Directory Comparison and Reconciliation Tool:** A new `oidcmprec` command, with improved functionality, replaces the old `oidreconcile` tool.

See Also:

[Chapter 38, "Setting Up Replication"](#)

[Chapter 41, "Managing and Monitoring Replication"](#)

The `oidcmprec` command-line tool reference in *Oracle Fusion Middleware Reference for Oracle Identity Management*

- **Java Server Plug-ins:** The Oracle Internet Directory Plug-in Framework now supports plug-ins written in Java and in PL/SQL.

See Also: [Chapter 43, "Developing Plug-ins for the Oracle Internet Directory Server"](#)

New Features Introduced with Oracle Internet Directory 10g Release 2

(10.1.2)

Notes:

The following chapters have been moved to *Oracle Fusion Middleware High Availability Guide*:

- "High Availability And Failover Considerations"
- "Oracle Application Server Cluster (Identity Management) Configurations"
- "Oracle Application Server Cold Failover Cluster (Identity Management)"
- "The Directory in an Oracle Real Application Clusters Environment"

The following appendixes have been rewritten as chapters in *Oracle Fusion Middleware Reference for Oracle Identity Management*:

- "Syntax for LDIF and Command-Line Tools"
 - "Oracle Internet Directory Schema Elements"
-
-

- **Improved integration with other components:** New features provide better integration with components such as Oracle Collaboration Suite. These features include service-to-service authentication, the service registry, and verifier generation using dynamic parameters.

See Also:

- ["The Service Registry and Service to Service Authentication"](#) on page 3-19
- ["Introduction to Generating Verifiers by Using Dynamic Parameters"](#) on page 30-10

- **Support for Certificate Matching Rule:** External authentication using certificates can now take either of two forms: an exact match, in which the subject DN of the client certificate is used to authenticate the user, or a certificate hash, in which the client certificate is hashed and is then compared with a certificate hash stored in the directory.

See Also: ["Direct Authentication"](#) on page 32-1

- **Ease of deployment for Replication:** Replication is now much easier to install, configure, and manage.

See Also:

[Chapter 38, "Setting Up Replication"](#)

- **Ease of deployment for Clusters:** Cluster configurations are now much easier to install, configure, and manage.
- **Enforcing access control for Oracle Internet Directory superuser:** The superuser is now subject to access control policies like any other user. New ACL keywords allow you to restrict superuser access through privileged groups.

See Also: [Chapter 29, "Managing Directory Access Control"](#)

- **Oracle Internet Directory Server Diagnostic Tool:** The OID Diagnostic Tool collects diagnostic information that helps triage issues reported on Oracle Internet Directory.

See Also: The `oiddiag` command-line tool reference in *Oracle Fusion Middleware Reference for Oracle Identity Management*

Part I

Understanding Directory Services

Part I explains what Oracle Internet Directory is and some of the concepts you must know before using it. It contains these chapters:

- [Chapter 1, "Introduction to Directory Services"](#)
- [Chapter 2, "Understanding Oracle Internet Directory in Oracle Fusion Middleware"](#)
- [Chapter 3, "Understanding Oracle Internet Directory Concepts and Architecture"](#)
- [Chapter 4, "Understanding Process Control of Oracle Internet Directory Components"](#)
- [Chapter 5, "Understanding Oracle Internet Directory Organization"](#)
- [Chapter 6, "Understanding Oracle Internet Directory Replication"](#)

Introduction to Directory Services

This chapter introduces online directories, provides an overview of the Lightweight Directory Application Protocol (LDAP) version 3, and explains some of the unique features and benefits of Oracle Internet Directory.

This chapter contains these topics:

- [What Is a Directory?](#)
- [What Is the Lightweight Directory Access Protocol \(LDAP\)?](#)
- [What Is Oracle Internet Directory?](#)
- [How Oracle Products Use Oracle Internet Directory](#)

What Is a Directory?

A directory is a hierarchically organized collection of entries with similar attributes. Directories list resources—for example, people, books in a library, or merchandise in a department store—and give details about each one. A directory can be either offline—for example, a telephone book or a department store catalog—or online.

Online directories are used by enterprises with distributed computer systems for fast searches, management of users and security, and integration of multiple applications and services. Online directories have become critical to e-businesses and hosted environments.

This section contains these topics:

- [The Expanding Role of Online Directories](#)
- [The Problem: Too Many Special-Purpose Directories](#)

The Expanding Role of Online Directories

An online directory is a specialized database that stores and retrieves collections of information about objects. Such information can represent any resources that require management: employee names, titles, and security credentials; information about partners; or information about shared network resources such as conference rooms and printers.

Online directories can be used by a variety of users and applications, and for a variety of purposes, including:

- An employee searching for corporate white page information, and, through a mail client, looking up e-mail addresses
- An application, such as a message transport agent, locating a user's mail server

- A database application identifying role information for a user

Although an online directory is a database—that is, a structured collection of data—it is not a relational database. The following table contrasts online directories with relational databases.

Table 1–1 Comparison of Online Directories and Relational Databases

Online Directories	Relational Databases
<p>Designed to handle relatively simple transactions on relatively small units of data. For example, an application might use a directory simply to store and retrieve an e-mail address, a telephone number, or a digital portrait.</p>	<p>Designed to handle large and diverse transactions using many operations on large units of data.</p>
<p>Designed to be location-independent. Directory-enabled applications expect, at all times, to see the same information throughout the deployment environment—regardless of which server they are querying. If a queried server does not store the information locally, then it must either retrieve the information or point the client application to it transparently.</p>	<p>Typically designed to be location-specific. While a relational database can be distributed, it usually resides on a particular database server.</p>
<p>Designed to store information in entries. These entries might represent any resource customers want to manage: employees, e-commerce partners, conference rooms, or shared network resources such as printers. Associated with each entry are several attributes, each of which may have one or more values assigned. For example, typical attributes for a person entry might include first and last names, e-mail addresses, the address of a preferred mail server, passwords or other login credentials, or a digitized portrait.</p>	<p>Designed to store information as rows in relational tables.</p>

The Problem: Too Many Special-Purpose Directories

In the past, some large companies had more than a hundred different directories, each designated for a special purpose. In addition, some applications had their own additional directories of user names.

Managing so many special purpose directories caused several problems, including:

- **High cost of administration:** Administrators had to maintain essentially the same information in many different places. For example, when an enterprise hired a new employee, administrators created a new user identity on the network, created a new e-mail account, added the user to the human-resources database, and set up all applications that the employee might need—for example, user accounts on development, testing, and production database systems. Later, if the employee left the company, administrators had to reverse the process to disable all these user accounts.
- **Inconsistent data:** Because of the large administrative overhead, it was difficult for multiple administrators, entering redundant information in multiple systems, to synchronize this employee information across all systems. The result was inconsistent data across the enterprise.

- Security issues: Each separate directory had its own password policy—which means that a user had to learn a variety of user names and passwords, each for a different system.

Today's enterprises need a more general purpose directory infrastructure, one based on a common standard for supporting a wide variety of applications and services.

What Is the Lightweight Directory Access Protocol (LDAP)?

LDAP is a standard, extensible directory access protocol that directory clients and servers use to communicate.

This section contains these topics:

- [LDAP and Simplified Directory Management](#)
- [LDAP Version 3](#)

LDAP and Simplified Directory Management

LDAP was conceived as an Internet-ready, lightweight implementation of the International Standardization Organization (ISO) X.500 standard for directory services. It requires a minimal amount of networking software on the client side, which makes it particularly attractive for Internet-based, thin client applications.

The LDAP standard simplifies management of directory information in three ways:

- It provides all users and applications in the enterprise with a single, well-defined, standard interface to a single, extensible directory service. This makes it easier to rapidly develop and deploy directory-enabled applications.
- It reduces the need to enter and coordinate redundant information in multiple services scattered across the enterprise.
- Its well-defined protocol and array of programmatic interfaces make it more practical to deploy Internet-ready applications that leverage the directory.

LDAP Version 3

The most recent version of LDAP, Version 3, was approved as a proposed Internet Standard by the Internet Engineering Task Force (IETF) in December 1997. LDAP Version 3 improves on LDAP Version 2 in several important areas:

- Globalization Support: LDAP Version 3 allows servers and clients to support characters used in every language in the world.
- Knowledge references (also called referrals): LDAP Version 3 implements a referral mechanism that allows servers to return references to other servers as a result of a directory query. This makes it possible to distribute directories globally by partitioning a directory information tree (DIT) across multiple LDAP servers.
- Security: LDAP Version 3 adds a standard mechanism for supporting Simple Authentication and Security Layer (SASL), providing a comprehensive and extensible framework for data security.
- Extensibility: LDAP Version 3 enables vendors to extend existing LDAP operations by using mechanisms called controls. These are extra pieces of information carried along with existing operations, altering the behavior of the operation. When a client application passes a control along with the standard LDAP command, the behavior of the commanded operation is altered accordingly. For example, when a

client wants to modify meta-information hidden in the directory, it can send the manageDSAIT control along with the LDAP command.

- Feature and schema discovery: LDAP Version 3 enables publishing information useful to other LDAP servers and clients, such as the supported LDAP protocols and a description of the directory schema.

See Also:

- RFCs (Requests for Comments) 2251-2256 of the IETF, available at: <http://www.ietf.org>
- [Appendix N, "RFCs Supported by Oracle Internet Directory"](#)
- ["Related Documents"](#) on page -xxxviii for an additional list of resources on LDAP
- [Chapter 3, "Understanding Oracle Internet Directory Concepts and Architecture"](#) for a conceptual discussion of directory information trees and knowledge references
- ["About LDAP Controls"](#) in *Oracle Fusion Middleware Reference for Oracle Identity Management* for a list and description of controls supported by Oracle Internet Directory

What Is Oracle Internet Directory?

Oracle Internet Directory is a general purpose directory service that enables fast retrieval and centralized management of information about dispersed users and network resources. It combines Lightweight Directory Access Protocol (LDAP) Version 3 with the high performance, scalability, robustness, and availability of an Oracle Database.

This section contains these topics:

- [Overview of Oracle Internet Directory](#)
- [Components of Oracle Internet Directory](#)
- [Advantages of Oracle Internet Directory](#)

Overview of Oracle Internet Directory

Oracle Internet Directory runs as an application on an Oracle Database. It communicates with the database by using Oracle Net Services, Oracle's operating system-independent database connectivity solution. The database may or may not be on the same host. [Figure 1-1](#) illustrates this relationship.

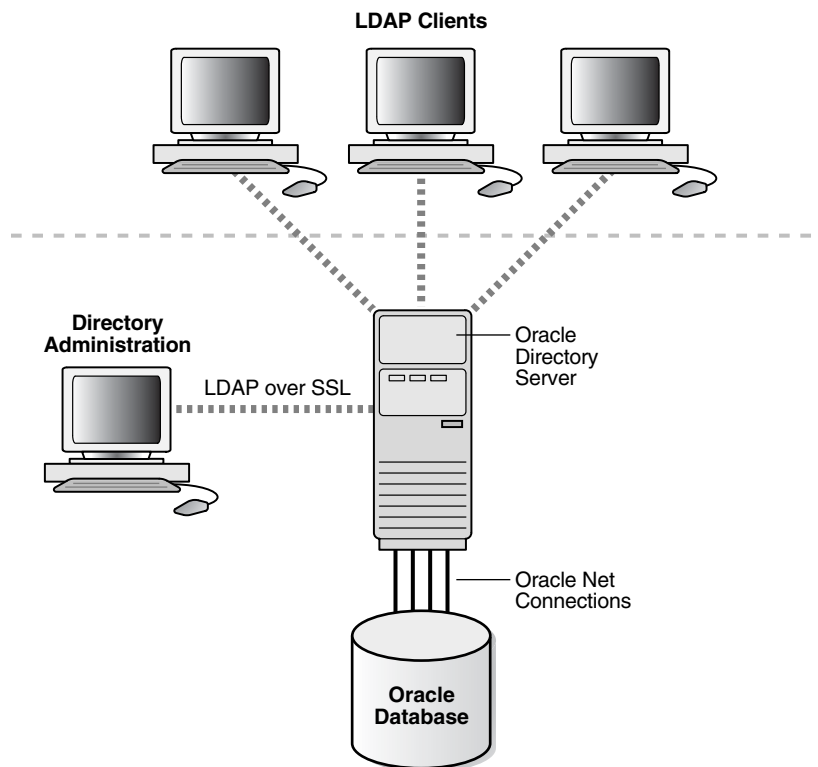
Figure 1–1 Oracle Internet Directory Overview

Components of Oracle Internet Directory

Oracle Internet Directory includes:

- Oracle directory server, which responds to client requests for information about people and resources, and to updates of that information, by using a multitiered architecture directly over TCP/IP
- Oracle directory replication server, which replicates LDAP data between Oracle directory servers
- Directory administration tools, which include:
 - The Oracle Internet Directory pages in Oracle Enterprise Manager Fusion Middleware Control
 - Oracle Directory Services Manager
 - Command-line administration and data management tools
- Oracle Internet Directory Software Developer's Kit

See Also: *Oracle Fusion Middleware Application Developer's Guide for Oracle Identity Management* for information about the Oracle Internet Directory Software Developer's Kit

Advantages of Oracle Internet Directory

Among its more significant benefits, Oracle Internet Directory provides scalability, high availability, security, and tight integration with the Oracle environment.

Scalability

Oracle Internet Directory exploits the strengths of an Oracle Database, enabling support for terabytes of directory information. In addition, such technologies as shared LDAP servers and database connection pooling enable it to support thousands of concurrent clients with subsecond search response times.

Oracle Internet Directory has a multi-threaded, multi-process and multi-instance physical architecture. This brings great flexibility to deployment options. Oracle Internet Directory can scale with a very high number of CPUs on SMP or NUMA hardware. With Oracle RAC database and the Oracle Internet Directory cluster configuration, you can deploy a single directory on multiple hardware nodes for horizontal scalability.

See Also: *Oracle Fusion Middleware High Availability Guide*

Oracle Internet Directory also provides data management tools, such as Oracle Directory Services Manager and a variety of command-line tools, for manipulating large volumes of LDAP data.

High Availability

Oracle Internet Directory offers the most comprehensive high availability configurations. Directory replication, active/passive cluster configuration, active/active cluster configuration with Oracle RAC Database, and Disaster Recovery configurations with Oracle Data Guard.

Oracle Internet Directory also takes advantage of all the availability features of the Oracle Database. Because directory information is stored securely in the Oracle Database, it is protected by Oracle's backup capabilities. Additionally, the Oracle Database, running with large data stores and heavy loads, can recover from system failures quickly.

Security

Oracle Internet Directory offers comprehensive and flexible access control. An administrator can grant or restrict access to a specific directory object or to an entire directory subtree. Moreover, Oracle Internet Directory implements three levels of user authentication: anonymous, password-based, and certificate-based using Secure Sockets Layer (SSL) Version 3 for authenticated access and data privacy.

With Oracle Database Vault, Oracle Internet Directory can restrict administrators and privileged users from accessing Directory data. With Oracle Transparent Data Encryption, Oracle Internet Directory can ensure protection of data on disk as well as on backups.

Integration with the Oracle Environment

Through Oracle Directory Integration Platform, Oracle Internet Directory provides a single point of integration between the Oracle environment and other directories such as NOS directories, third-party enterprise directories, and application-specific user repositories.

How Oracle Products Use Oracle Internet Directory

Oracle products use Oracle Internet Directory for easier administration, tighter security, and simpler integration between multiple directories.

This section contains these topics:

- [Easier and More Cost-Effective Administration of Oracle Products](#)
- [Tighter Security Through Centralized Security Policy Administration](#)
- [Integration of Multiple Directories](#)

Easier and More Cost-Effective Administration of Oracle Products

Oracle Platform Security Services stores users and groups in an embedded LDAP repository by default. Domains can be configured, however, to use identity data in LDAP repositories, such as Oracle Internet Directory. In addition, Oracle WebLogic Server provides a generic LDAP authenticator that can be used with other LDAP servers.

By default, OPSS stores policies and credentials in file-based stores. These stores can be changed (or reassociated) to an LDAP repository backed by an Oracle Internet Directory or an Oracle Virtual Directory server.

Oracle Webcenter Suite bases its security on OPSS. It can delegate enforcement to Oracle Internet Directory for identity, policy, and credential storage. You can use LDAP commands to add or modify users and to search the directory, which can be useful when exporting and importing user accounts.

Oracle Access Manager supports storing user, configuration, and policy data in directories, such as Oracle Internet Directory (multiple realms). You can store data either together on the same directory server or on different directory servers.

Oracle Net Services uses Oracle Internet Directory to store and resolve database services and the simple names, called net service names, that can be used to represent them.

Tighter Security Through Centralized Security Policy Administration

The **Oracle Database** uses Oracle Internet Directory to store user names and passwords, along with authorization information such as enterprise roles. It uses Oracle Internet Directory to store a password verifier along with the entry of each user.

Oracle Enterprise User Security uses Oracle Internet Directory for:

- Central Management of user authentication credentials

Instead of storing a user's database password in each database, Oracle Advanced Security stores it in one place: the directory. It stores the password as an attribute of the user entry.
- Central management of user authorizations

Oracle Advanced Security uses directory entries, called enterprise roles, to determine the privileges for a given enterprise user within a given schema, whether that schema is shared or owned. Enterprise roles are containers for database-specific global roles. For example, a user might be assigned the enterprise role of clerk, which might contain the global role of hrclerk with its attendant privileges on the human resources database and the global role of analyst with its attendant privileges on the payroll database.
- Mappings to shared schemas

Oracle Advanced Security uses mappings—that is, directory entries that point an enterprise user to shared application schemas on the database instead of to an individual account. For example, you might map several enterprise users to the schema `sales_application` instead of to separate accounts in their names.

- Single password authentication

In the Oracle Database, Oracle Advanced Security enables enterprise users to authenticate to multiple databases by using a single, centrally managed password. The password is stored in the directory as an attribute of the user's entry and is protected by encryption and access control lists. This spares you from setting up Secure Sockets Layer (SSL) on clients and users from having to remember multiple passwords.
- Central storage of PKI credentials

In Oracle Database and Oracle Application Server, user wallets can be stored in the directory as an attribute of the user's entry. Storing wallets in this manner enables mobile users to retrieve and open their wallets by using Enterprise Login Assistant. While the wallet is open, authentication is transparent—that is, users can access any database on which they own or share a schema without having to authenticate again.

Integration of Multiple Directories

Another directory services product, Oracle Virtual Directory, provides a single, dynamic access point to multiple data sources through LDAP or XML protocols. It does this by providing a real-time data join and an abstraction layer that exposes a single logical directory, without the need to synchronize or move data from its native location. Oracle Virtual Directory can provide multiple application-specific views of identity data stored in, for example, Oracle Internet Directory, Microsoft Active Directory and Sun Java Systems Directory instances, and can also be used to secure data access to the application-specific sources and enhance high-availability to existing data-sources. These capabilities accelerate the deployment of applications and reduce costs by eliminating the need to consolidate user information before an application can be deployed. Oracle Virtual Directory can constantly adapt those applications to a changing identity landscape as user repositories are added, changed, or removed. Oracle Virtual Directory provides the following benefits:

- Consolidates multiple directories
- Provides virtualization and distribution of directory services
- Reduces administrative cost and improves security
- Extends enterprise applications quickly
- Provides ubiquitous access to information
- Lowers cost of implementation

See Also: *Oracle Fusion Middleware Administrator's Guide for Oracle Virtual Directory*

Oracle Directory Integration Platform is a collection of interfaces and services for integrating multiple directories by using Oracle Internet Directory and several associated plug-ins and connectors. It provides these benefits:

- All Oracle components are pre-certified to work with Oracle Internet Directory.
- You can integrate the entire Oracle environment with third-party directories simply by integrating each third-party directory with Oracle Internet Directory. This saves you from having to integrate each application with each directory.

See Also: *Oracle Fusion Middleware Administrator's Guide for Oracle Directory Integration Platform*

Understanding Oracle Internet Directory in Oracle Fusion Middleware

As of 11g Release 1 (11.1.1), Oracle Internet Directory has been integrated with a common management infrastructure that in turn uses Oracle WebLogic Server. This product set is called Oracle Fusion Middleware.

See Also: The chapter entitled "Understanding Oracle Fusion Middleware Concepts" in *Oracle Fusion Middleware Administrator's Guide*.

This chapter describes some features of Oracle Fusion Middleware that affect Oracle Internet Directory management.

This chapter contains the following sections:

- [WebLogic Server Domain](#)
- [Oracle Internet Directory as a System Component](#)
- [Oracle Internet Directory Deployment Options](#)
- [Middleware Home](#)
- [WebLogic Server Home](#)
- [Oracle Home](#)
- [Oracle Instance](#)
- [Oracle Enterprise Manager Fusion Middleware Control](#)
- [Logging, Auditing, and Diagnostics](#)
- [MBeans and the WebLogic Scripting Tool](#)

WebLogic Server Domain

A WebLogic Server administration domain is a logically related group of Java components. Domains include a special WebLogic Server instance called the Administration Server, which is the central point from which you configure and manage all resources in the domain. Usually, you configure a domain to include additional WebLogic Server instances called managed servers. You deploy Java components, such as Web applications and Web services, and other resources onto the managed servers and use the Administration Server for configuration and management purposes only. The managed servers can be grouped together into a cluster.

Oracle Internet Directory as a System Component

Oracle Internet Directory is a system component. That is, it is a manageable process that is not an Oracle WebLogic Server. System components can use the WebLogic Administrative Domain for management services, including Oracle Enterprise Manager Fusion Middleware Control, Audit Framework, configuration management through MBeans and Secure Sockets Layer and Wallet Management. The Oracle WebLogic Server Administration Server controls Oracle Internet Directory and other system components through OPMN.

Oracle Internet Directory itself is a C-based process. Its only run time dependency is the Oracle Database. To be managed by the Oracle Fusion Middleware management framework, Oracle Internet Directory must register itself with a local or a remote Oracle WebLogic Server administration domain during installation or from the command line after installation. Therefore, an Oracle Internet Directory 11g installation requires either a local or a remote installation of Oracle WebLogic Server. Also, the Directory Management user interface, ODSM, is a Java component deployed on Oracle WebLogic Server.

If you must manage Oracle Internet Directory in your deployment using only command-line tools and a remote ODSM, there is also an option to install and configure Oracle Internet Directory without registering with a Oracle WebLogic Server Domain.

Oracle Internet Directory Deployment Options

During installation, there are four deployment options for Oracle Internet Directory:

1. **Create New Domain**—Oracle Internet Directory with a local Oracle WebLogic Server Domain. Oracle WebLogic Server is installed locally with Oracle Internet Directory and an admin domain is created for Oracle Internet Directory.
2. **Extend Existing Domain**—Oracle Internet Directory with a remote Oracle WebLogic Server Domain. Oracle WebLogic Server admin server and domain have been installed and created separately and Oracle Internet Directory registers with the Domain remotely.
3. **Expand Cluster**—Oracle Internet Directory in an Oracle WebLogic Server cluster for High Availability. This option will not be discussed here.
4. **Configure Without Domain**—Oracle Internet Directory without a Oracle WebLogic Server Domain. Oracle Internet Directory can be installed and configured without Oracle WebLogic Server and without registering to any Oracle WebLogic Server Admin Domains. In this case, Oracle Internet Directory cannot be managed by Oracle Enterprise Manager Fusion Middleware Control or other common Oracle Fusion Middleware management services. You must rely on command-line utilities such as `opmnctl` and the LDAP tools. ODSM can be deployed separately and used to manage Oracle Internet Directory.

If you choose **Create New Domain** or **Extend Existing Domain**, the Oracle Internet Directory component you create is registered with that domain when the installation is complete.

If you choose **Configure Without Domain**, the Oracle Internet Directory component is not registered with any domain when the installation is complete. You will be unable to manage Oracle Internet Directory, or any other component in that Oracle instance, with Oracle Enterprise Manager Fusion Middleware Control until you register the component with a WebLogic domain by using the command-line tool `opmnctl`.

Middleware Home

A Middleware home consists of the WebLogic Server home, and optionally one or more other Oracle product homes (also known as Oracle homes). A middleware home can reside on a local file system or on a remote shared disk that is accessible through NFS. The Oracle Fusion Middleware home is represented in path names as *MW_HOME*.

WebLogic Server Home

A WebLogic Server home contains installed files necessary to host a WebLogic Server. The WebLogic Server home directory is a peer of other Oracle home directories underneath the middleware home directory. In path names, it is represented as *WLS_HOME*.

Oracle Common Home

The Oracle home that contains the binary and library files required for the Oracle Enterprise Manager Fusion Middleware Control and Java Required Files (JRF). There can be only one Oracle Common home within each Middleware home. In path names, it is represented as *ORACLE_COMMON_HOME*.

Oracle Home

An Oracle home contains installed files necessary to host a specific software suite. An Oracle home resides within the directory structure of the Middleware home. Each Oracle home can be associated with multiple Oracle instances

The Oracle home is usually represented in path names as *ORACLE_HOME*. Each Oracle home can be associated with multiple Oracle instances or Weblogic server domains.

Oracle Instance

In 11g Release 1 (11.1.1), product configuration data has been separated from product binaries. The product binaries reside in the Oracle home, *ORACLE_HOME*, while updatable files reside in an Oracle instance, represented in path names as *ORACLE_INSTANCE*.

Most Oracle Internet Directory commands require that you set the environment variable *ORACLE_INSTANCE* to the value of *ORACLE_INSTANCE*. You dereference this variable as *\$ORACLE_INSTANCE* on UNIX or Linux systems and as *%ORACLE_INSTANCE%* on Windows.

All configuration files, repositories, log files, deployed applications, and temporary files reside in a oracle instance. Keeping updatable files separate from non-updatable files facilitates administrative tasks such as patching, upgrades, backup and restore, and cloning. It allows administrators to have their run-time and install-time binaries follow independent life cycles.

Oracle instance refers not only to a physical location on disk but also encompasses the associated processes. An Oracle instance contains one or more active middleware system components, such as Oracle Virtual Directory or Oracle Internet Directory. You determine which components are part of an instance, either at install time or by creating and configuring an instance at a later time.

When you install Oracle Internet Directory on a host computer, Oracle Identity Management 11g Installer creates an Oracle Fusion Middleware component of type

OID in a new or existing Oracle instance. The component name for the first Oracle Internet Directory component is `oid1`.

Oracle Identity Management 11g Installer also creates some directories in the filesystem under the Oracle instance, including the following, when you install Oracle Internet Directory:

```
ORACLE_INSTANCE/config/OID/componentName
ORACLE_INSTANCE/diagnostics/logs/OID/componentName
ORACLE_INSTANCE/diagnostics/logs/OID/tools
ORACLE_INSTANCE/OID/admin
ORACLE_INSTANCE/OID/admin/SSLwallet-name
ORACLE_INSTANCE/OID/load
ORACLE_INSTANCE/tmp
```

Oracle Enterprise Manager Fusion Middleware Control

As of release 11g, you create, configure, and manage many Oracle Internet Directory features by using Oracle Enterprise Manager Fusion Middleware Control and Oracle Directory Services Manager.

Fusion Middleware Control enables you to configure and manage all Oracle products from one user interface. You can perform most configuration functions in Fusion Middleware Control that you can perform from the command line. Oracle Enterprise Manager Fusion Middleware Control also includes wizards for setting up replication and for estimating sizing and tuning needs.

Oracle Directory Services Manager is an additional administrative interface for Oracle Internet Directory and Oracle Virtual Directory. It is accessible from Oracle Enterprise Manager Fusion Middleware Control or directly from its own URL.

Logging, Auditing, and Diagnostics

Using Oracle Enterprise Manager Fusion Middleware Control, you can monitor the Oracle Internet Directory Server and related components and activities.

Using the monitoring functions, you can gain insight into system activity and performance, for example, total logins, successful and unsuccessful logins, average login time, request latencies, LDAP connections, and so on.

You can monitor the following items:

- **Metrics:** To monitor system health
- **General:** A high-level rollup of load, performance, security, login, CPU utilization, and other data
- **Performance:** Key metrics for the directory server and its host
- **Reports:** Data on operation success and failure
- **Topology:** Information on the Oracle HTTP Server instances, directory server instances, associated databases, and other components

MBeans and the WebLogic Scripting Tool

The Oracle WebLogic Scripting Tool (WLST) is a command-line scripting environment that you can use to create, manage, and monitor Oracle WebLogic Server domains. It is

based on the Java scripting interpreter, Jython. You can use WLST to perform some Oracle Internet Directory management operations.

A managed bean (MBean) is a Java object that represents a JMX manageable resource in a distributed environment, such as an application, a service, a component or a device. When Oracle Internet Directory is registered with an Oracle WebLogic Server Admin Domain, Oracle Internet Directory MBeans are deployed in the Oracle WebLogic Server Admin Server. These MBeans enable management of Oracle Internet Directory configuration through Oracle Enterprise Manager Fusion Middleware Control or WLST.

See Also: *Oracle Fusion Middleware Administrator's Guide*

Understanding Oracle Internet Directory Concepts and Architecture

This chapter provides conceptual descriptions of the basic elements of Oracle Internet Directory and discusses Oracle Internet Directory architecture.

This chapter contains these topics:

- [Oracle Internet Directory Architecture](#)
- [How Oracle Internet Directory Processes a Search Request](#)
- [Directory Entries](#)
- [Attributes](#)
- [Object Classes](#)
- [Naming Contexts](#)
- [Security](#)
- [Globalization Support](#)
- [Distributed Directories](#)
- [Knowledge References and Referrals](#)
- [Oracle Delegated Administration Services and the Oracle Internet Directory Self-Service Console](#)
- [The Service Registry and Service to Service Authentication](#)
- [Oracle Directory Integration Platform](#)
- [Oracle Internet Directory and Identity Management](#)
- [Resource Information](#)

See Also: ["Related Documents"](#) on page -xxxviii for suggestions on further reading about LDAP-compliant directories

Oracle Internet Directory Architecture

This section contains these topics:

- [An Oracle Internet Directory Node](#)
- [An Oracle Directory Server Instance](#)
- [Oracle Internet Directory Ports](#)
- [Directory Metadata](#)

An Oracle Internet Directory Node

An Oracle Internet Directory node consists of one or more directory server instances connected to the same directory store. The directory store—that is, the repository of the directory data—is an Oracle Database.

Note: All Oracle Internet Directory instances in the same domain connect to the same Oracle Database.

Figure 3–1 on page 3-2 shows the various directory server elements and their relationships running on a single node.

Oracle Net Services is used for all connections between the Oracle database server and:

- The Oracle directory server non-SSL port (3060 by default)
- The Oracle directory server SSL-enabled port (3131 by default)
- The OID Monitor

LDAP is used for connections between directory server and:

- Oracle Directory Services Manager
- Oracle directory replication server

The Oracle directory server instance and the Oracle directory replication server connect to OID Monitor by way of the operating system.

Figure 3–1 A Typical Oracle Internet Directory Node

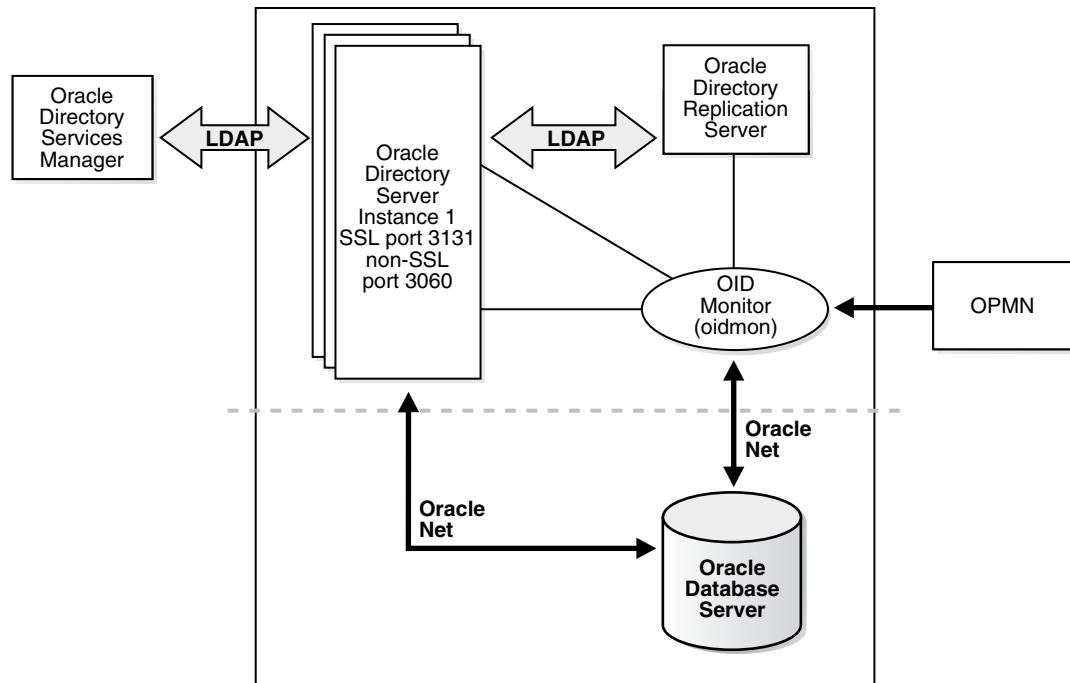

As shown in Figure 3–1, an Oracle Internet Directory node includes the following major elements:

Table 3–1 An Oracle Internet Directory Node

Element	Description
Oracle directory server instance	Also called either an LDAP server instance or a directory server instance, it services directory requests through a single Oracle Internet Directory dispatcher process listening at specific TCP/IP ports. There can be more than one directory server instance on a node, listening on different ports.
Oracle directory replication server	Also called a replication server, it tracks and sends changes to replication servers in another Oracle Internet Directory system. There can be only one replication server on a node. You can choose whether to configure the replication server.
Oracle Database Server	Stores the directory data. Oracle strongly recommends that you dedicate a database for use by the directory. The database can reside on the same node as the directory server instances.
Oracle Process Manager and Notification Server (OPMN)	Manages Oracle Internet Directory as an Oracle Fusion Middleware system component. OPMN uses the directives in the OID component snippet in <code>ORACLE_INSTANCE/config/OPMN/opmn/opmn.xml</code> and invokes <code>OIDMON</code> and <code>OIDCTL</code> as required. The command-line utility is <code>ORACLE_INSTANCE/bin/opmnctl</code> .
OID Monitor (OIDMON)	<p>Initiates, monitors, and terminates the LDAP server and replication server processes. When you invoke process management commands, such as <code>oidctl</code> or <code>opmnctl</code>, or when you use Fusion Middleware Control to start or stop server instances, your commands are interpreted by this process.</p> <p>OIDMON also monitors servers and restarts them if they have stopped running for abnormal reasons.</p> <p>OIDMON starts a default instance of <code>OIDLDAPD</code>. If the default instance of <code>OIDLDAPD</code> is stopped using the <code>OIDCTL</code> command, then <code>OIDMON</code> stops the instance. However, when <code>OIDMON</code> is restarted by <code>OPMN</code>, <code>OIDMON</code> restarts the default instance.</p> <p>All <code>OID Monitor</code> activity is logged in the file <code>ORACLE_INSTANCE/diagnostics/logs/OID/Component_Name/oidmon-xxxx.log</code>. This file is on the Oracle Internet Directory server file system.</p> <p><code>OID Monitor</code> checks the state of the servers through mechanisms provided by the operating system.</p>
OID Control Utility (OIDCTL)	Communicates with <code>OID Monitor</code> by placing message data in Oracle Internet Directory server tables. This message data includes configuration parameters required to run each Oracle directory server instance. Normally used from the command line only to stop and start the replication server. <code>OIDCTL</code> is also used for checking the status of Oracle Internet Directory.

The Oracle directory replication server uses LDAP to communicate with an Oracle directory (LDAP) server instance. To communicate with the database, all components use OCI/Oracle Net Services. Oracle Directory Services Manager and the command-line tools communicate with the Oracle directory servers over LDAP.

An Oracle Directory Server Instance

Figure 3–2 illustrates an Oracle directory server instance, also called an LDAP server instance.

Figure 3–2 Oracle Directory Server Instance Architecture

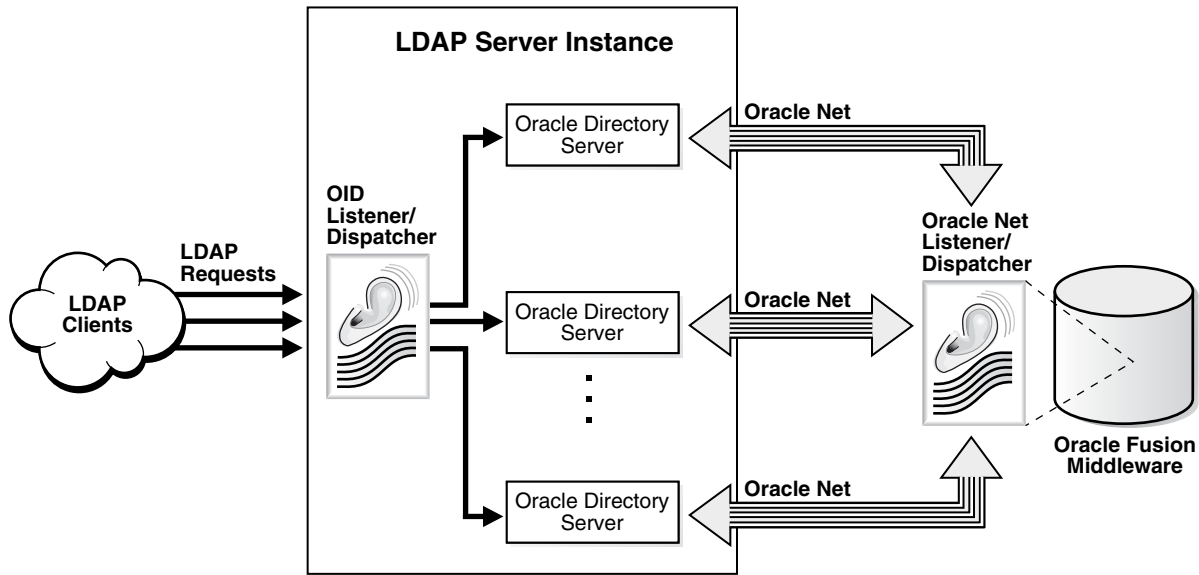

One instance comprises one dispatcher process and one or more server processes. The Oracle Internet Directory dispatcher and server processes can use multiple threads to distribute the load. LDAP clients send LDAP requests to an Oracle Internet Directory listener/dispatcher process listening for LDAP commands at its port.

Oracle Internet Directory listener/dispatcher starts a configured number server process at startup time. The number of server processes is controlled by the `orclserverprocs` attribute in the instance-specific configuration entry. The default value for `orclserverprocs` is 1. Multiple server processes enable Oracle Internet Directory to take advantage of multiple processor systems.

The Oracle Internet Directory dispatcher process sends the LDAP connections to the Oracle Internet Directory server process in a round robin fashion. The maximum number of LDAP connections accepted by each server is 1024 by default. This number can be increased by changing the attribute `orclmaxldapconns` in the instance-specific configuration entry, which has a DN of the form:

```
cn=componentname,cn=osdldapd,cn=subconfigsentry
```

Oracle Internet Directory Ports

An Oracle Internet Directory component can be created by Oracle Identity Management 11g Installer or by a command-line tool. The program that creates Oracle Internet Directory follows specific steps in assigning the SSL and non-SSL port. First, it attempts to use 3060 as the non-SSL port. If that port is unavailable, it tries ports in the range 3061 to 3070, then 13060 to 13070.

Similarly, the program that creates Oracle Internet Directory attempts to use 3131 as its SSL port, then ports in the range 3132 to 3141, then 13131 to 13141.

Directory Metadata

Directory metadata is the information used by the directory server during run time for processing LDAP requests. It is stored in the underlying data repository. During startup, the directory server reads this information and stores it in a local metadata

cache. It then uses this cache during its run time to process incoming LDAP operation requests.

Note: The metadata cache is a write-through cache. An LDAP operation first writes to the database and then invalidates the corresponding cache entry. A subsequent search of that entry causes the cache to be refreshed.

The directory server has the following types of metadata in its local metadata cache:

- Directory Schema

The definitions of object classes, attributes, and matching rules supported by the directory server. The directory server uses this information during creation and modification of directory objects. A directory object is a collection of object classes and their associated attributes and matching rules. See [Chapter 20, "Managing Directory Schema."](#)

- Access control policy point (ACP)

A directory administrative domain for defining and controlling access to the information in that domain. The directory server uses ACPs when determining whether to allow a certain LDAP operation performed by a user. See [Chapter 29, "Managing Directory Access Control."](#)

- Root DSE entry

The root DSE (Directory Service Agent-Specific Entry) contains several attributes that store information about the directory server itself. For example, these attributes contain the following information items, to mention just a few:

- Naming contexts DNs
- Sub Schema Subentry DN
- Superior references (referrals) DNs
- Special entry DNs like Oracle Internet Directory configuration and registry containers
- Special Entry DNs like change log and change status containers
- DN of replications agreement container

See ["Attributes of the DSE"](#) on page 9-10.

- Privilege groups

Groups that can be used in access control policies.

The directory schema supports directory group objects through the standard `groupofuniqueNames` and `groupofNames` object classes. These object classes hold information for such groups as distribution lists and mailing lists to mention just two.

Oracle Internet Directory extends these standard group objects through an auxiliary object class called `orclprivilegeGroup`. This object class, which supports privilege groups that can be used in access control policies, provides flexibility to grant or deny access to groups of users. The directory server uses this information during:

- LDAP bind operations to find out the subscribed privileged groups for a given user

- Access control policy evaluation if the policy has directives that grant or deny access to privileged groups

See Also: [Chapter 14, "Managing Dynamic and Static Groups"](#)

- **Catalog entry**
A special entry containing information about indexed attributes in the underlying database. The directory uses this information during directory search operations. See ["About Indexing Attributes"](#) on page 20-6.
- **Common entry**
A special entry containing information about hosted companies. A hosted company is an enterprise to which another enterprise provides services. The metadata in this entry includes the hosted company DN, user search base, nickname and other attributes, all of which are described in [Chapter 33, "Planning, Deploying and Managing Realms"](#).
- **Plug-in entry**
A special entry containing information about the kind of operation that triggers a plug-in event, and the point in the operation when that plug-in is to be triggered. [Chapter 43, "Developing Plug-ins for the Oracle Internet Directory Server,"](#) describes this information.
- **Password verifier entry**
A special entry containing information about the encryption and verifier attribute types. [Chapter 30, "Managing Password Verifiers,"](#) describes this information.
- **Password policy entry**
One or more special entries containing information about policies enforced by the directory server for the user password credentials. The directory server uses this information during run time to enforce the password policies. See [Chapter 28, "Managing Password Policies"](#).

How Oracle Internet Directory Processes a Search Request

This example shows you how Oracle Internet Directory processes a search request.

1. The user or client enters a search request that is conditioned by one or more of the following options:
 - **SSL:** The client and server can establish a session that uses SSL encryption and authentication, or SSL encryption only. If SSL is not used, the client's message is sent in clear text.
 - **Type of user:** The user can seek access to the directory either as a particular user or as an anonymous user, depending on which of the two has the necessary privileges to perform the desired function.
 - **Filters:** The user can narrow the search by using one or more search filters, including those that use the Boolean conditions "and," "or," and "not," and those that use other operators such as "greater than," "equal to," and "less than".
2. The C API, using the LDAP protocol, sends a request to a directory server instance to connect to the directory.

3. The directory server authenticates the user, a process called binding. The directory server also checks the Access Control Lists (ACLs) to verify that the user is authorized to perform the requested search.
4. The directory server converts the search request from LDAP to Oracle Call Interface (OCI)/Oracle Net Services and sends it to the Oracle Database.
5. The Oracle Database retrieves the information and passes it back through the chain—to the directory server, then to the C API, and, finally, to the client.

Note: The maximum number of attributes you can specify in a search filter is 255.

Directory Entries

In an online directory, each collection of information about an object is called an entry. An entry can include, for example, information about an employee, a conference room, an e-commerce partner, or a shared network resource such as a printer.

This section contains these topics:

- [Distinguished Names \(DNs\) and Directory Information Trees \(DITs\)](#)
- [Entry Caching](#)

Distinguished Names (DNs) and Directory Information Trees (DITs)

Each entry in an online directory is uniquely identified by a distinguished name (DN). The distinguished name tells you exactly where the entry resides in the directory hierarchy. This hierarchy is represented by a directory information tree (DIT).

To understand the relation between a distinguished name and a directory information tree, look at [Figure 3-3](#).

Figure 3-3 A Directory Information Tree

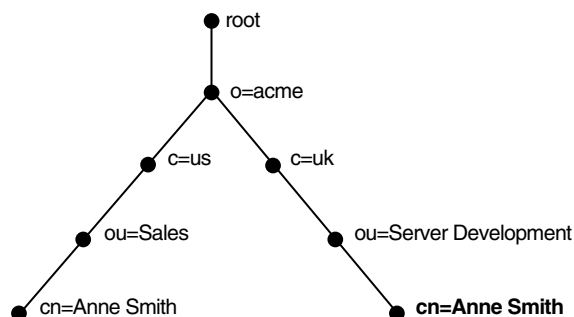

The DIT in [Figure 3-3](#) includes entries for two employees of Acme Corporation who are both named Anne Smith. It is structured along geographical and organizational lines. The Anne Smith contained in the left branch works in the Sales division in the United States, while the other works in the Server Development division in the United Kingdom.

The Anne Smith contained in the right branch has the common name (cn) Anne Smith. She works in an organizational unit (ou) named Server Development, in the country (c) of United Kingdom of Great Britain and Northern Ireland (uk), in the organization (o) Acme.

The DN for this "Anne Smith" entry is:

```
cn=Anne Smith,ou=Server Development,c=uk,o=acme
```

Note that the conventional format of a distinguished name places the lowest DIT component at the left, then follows it with the next highest component, moving progressively up to the root.

Within a distinguished name, the lowest component is called the relative distinguished name (RDN). For example, in the previous entry for Anne Smith, the RDN is `cn=Anne Smith`. Similarly, the RDN for the entry immediately above Anne Smith's RDN is `ou=Server Development`, the RDN for the entry immediately above `ou=Server Development` is `c=uk`, and so on. A DN is thus a concatenation of RDNs that reflects parent-child relationships in the DIT. Within the DN, RDNs are separated by commas.

To locate a particular entry within the overall DIT, a client uniquely identifies that entry by using the full DN—not simply the RDN—of that entry. For example, within the global organization in [Figure 3-3](#), to avoid confusion between the two Anne Smiths, you would use each one's full DN. If there are potentially two employees with the same name in the same organizational unit, you could use additional mechanisms—for example, you could identify each employee with a unique number.

Entry Caching

To make operations on entries quick and efficient, Oracle Internet Directory uses entry caching. When you enable this feature, Oracle Internet Directory assigns a unique identifier to each entry, then stores a specified number of those identifiers in cache memory. When a user performs an operation on an entry, the directory server looks in the cache for the entry identifier, then retrieves the corresponding entry from the directory. This method enhances Oracle Internet Directory performance, and is especially useful in smaller and medium-sized enterprises.

Notes:

- You can use entry caching only in the case of a single server, single instance Oracle Internet Directory node.
 - The entry cache is a write-through cache. An LDAP operation first writes to the database and then invalidates the corresponding cache entry. A subsequent search of that entry causes the cache to be refreshed.
-
-

See Also: [Chapter 19, "Managing Knowledge References and Referrals"](#)

Attributes

In a typical telephone directory, an entry for a person contains such information items as an address and a phone number. In an online directory, such an information item is called an attribute. Attributes in a typical employee entry can include, for example, a job title, an e-mail address, or a phone number.

For example, in [Figure 3-4](#), the entry for Anne Smith in Great Britain (uk) has several attributes, each providing specific information about her. These are listed in the balloon to the right of the tree, and they include `emailaddr`, `printername`, `jpegPhoto`, and `app preferences`. Moreover, each bullet in [Figure 3-4](#) is also an entry with attributes, although the attributes for each are not shown.

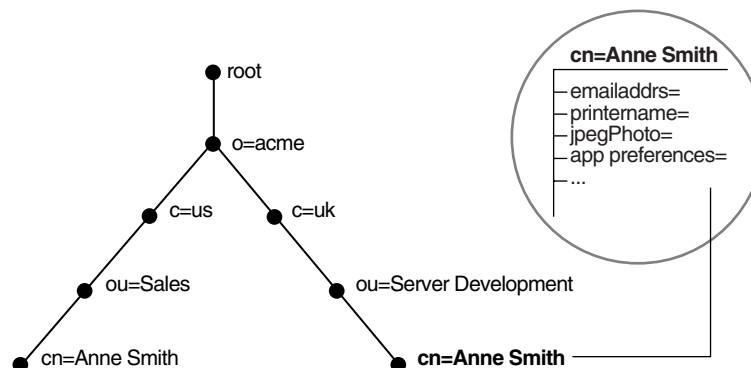
Figure 3–4 Attributes of the Entry for Anne Smith

Each attribute consists of an attribute type and one or more attribute values. The attribute type is the kind of information that the attribute contains—for example, `jobTitle`. The attribute value is the particular occurrence of information appearing in that entry. For example, the value for the `jobTitle` attribute could be `manager`.

This section contains these topics:

- [Kinds of Attribute Information](#)
- [Single-Valued and Multivalued Attributes](#)
- [Common LDAP Attributes](#)
- [Attribute Syntax](#)
- [Attribute Matching Rules](#)
- [Attribute Options](#)

Kinds of Attribute Information

Attributes contain two kinds of information.

- **Application Attributes**
This information is maintained and retrieved by directory clients and is unimportant to the operation of the directory. A telephone number, for example, is application information.
- **System Configuration Attributes**
This information pertains to the operation of the directory itself. Some operational information is specified by the directory to control the server—for example, the time stamp for the creation or modification of an entry, or the name of the user who creates or modifies an entry. Other operational information, such as access information, is defined by administrators and is used by the directory program in its processing.

See Also: [Chapter 9, "Managing System Configuration Attributes"](#) for more information about system configuration attributes.

To enhance your ability to search for entries, Oracle Internet Directory automatically creates several system configuration attributes when you add an entry to the directory. These include:

Table 3–2 Attributes Created with Each New Entry

Attribute	Description
creatorsName	Name of the person creating the entry
createTimestamp	Time of entry creation in UTC (Coordinated Universal Time)
modifiersName	Name of person modifying the entry
modifyTimestamp	Time of last entry modification in UTC

Moreover, when a user modifies an entry, Oracle Internet Directory automatically updates the `modifiersName` and `modifyTimestamp` attributes to, respectively, the name of the person modifying the entry, and the time of the entry modification in UTC.

See Also: [Chapter 9, "Managing System Configuration Attributes"](#) for instructions on configuring system configuration attributes

Single-Valued and Multivalued Attributes

Attributes can be either single-valued or multivalued. Single-valued attributes carry only one value in the attribute, whereas multivalued attributes can have several. An example of a multivalued attribute is a group membership list with names of everyone in the group.

Common LDAP Attributes

Oracle Internet Directory implements all of the standard LDAP attributes. Some of the more common ones defined by RFC 2798 of the Internet Engineering Task Force (IETF) are shown in [Table 3–3](#).

Table 3–3 Common LDAP Attributes

Attribute Type	Attribute String	Description
commonName	cn	Common name of an entry—for example, Anne Smith.
domainComponent	dc	The DN of the component in a Domain Name System (DNS)—for example, dc=uk, dc=acme, dc=com.
jpegPhoto	jpegPhoto	Photographic image in JPEG format. This is stored in binary format.
organization	o	Name of an organization—for example, my_company.
organizationalUnitName	ou	Name of a unit within an organization—for example, Server Development.
owner	owner	Distinguished name of the person who owns the entry, for example, cn=Anne Smith, ou=Server Development, o= Acme, c=uk.
surname, sn	sn	Last name of a person—for example, Smith.
telephoneNumber	telephoneNumber	Telephone number—for example, (650) 123-4567 or 6501234567.

See Also: "Oracle Identity Management LDAP Attribute Reference" in *Oracle Fusion Middleware Reference for Oracle Identity Management* for a list of several attributes Oracle Internet Directory provides.

Attribute Syntax

Attribute syntax is the format of the data that can be loaded into each attribute. For example, the syntax of the `telephoneNumber` attribute might require a telephone number to be a string of numbers containing spaces and hyphens. However, the syntax for another attribute might require specifying whether the data has to be in the form of a date, or whether the data can consist of numbers only. Each attribute must have one and only one syntax.

Oracle Internet Directory recognizes most of the syntaxes specified in RFC 2252 of the Internet Engineering Task Force (IETF), allowing you to associate most of the syntaxes described in that document with an attribute. In addition to recognizing the syntaxes in RFC 2252, Oracle Internet Directory also enforces some LDAP syntaxes. You cannot add new syntaxes beyond those already supported by Oracle Internet Directory.

See Also: "About LDAP Attribute Syntax" in *Oracle Fusion Middleware Reference for Oracle Identity Management*

Attribute Matching Rules

In response to most incoming client requests, the directory server performs search and compare operations. During these operations, the directory server consults the relevant matching rule to determine equality between the attribute value sought and the attribute value stored. For example, matching rules associated with the `telephoneNumber` attribute could cause "(650) 123-4567" to be matched with either "(650) 123-4567" or "6501234567" or both. When you create an attribute, you associate a matching rule with it.

Oracle Internet Directory implements all the standard LDAP matching rules. You cannot add new matching rules beyond those already supported by Oracle Internet Directory.

See Also:

- [Chapter 20, "Managing Directory Schema"](#) for information on viewing matching rules.
- "About LDAP Matching Rules" in *Oracle Fusion Middleware Reference for Oracle Identity Management*

Attribute Options

An attribute type can have various options that enable you to specify how the value for that attribute is made available in a search or a compare operation. For example, suppose that an employee has two addresses, one in London, the other in New York. Options for that employee's `address` attribute could allow you to store both addresses.

Moreover, attribute options can include language codes. For example, options for John Doe's `givenName` attribute could enable you to store his given name in both French and Japanese.

For clarity, we can distinguish between an attribute with an option and its base attribute, which is the same attribute without an option. For example, in the case of

`givenName; lang-fr=Jean`, the base attribute is `givenName`; the French value for that base attribute is `givenName; lang-fr=Jean`.

An attribute with one or more options inherits the properties—for example, matching rules and syntax—of its base attribute. To continue the previous example, the attribute with the option `cn; lang-fr=Jean` inherits the properties of `cn`.

Note: You cannot use an attribute option within a DN. For example, the following DN is incorrect: `cn; lang-fr=Jean, ou=sales, o=acme, c=uk`.

See Also: [Chapter 13, "Managing Directory Entries."](#)

Object Classes

An object class is a group of attributes that define the structure of an entry. When you define a directory entry, you assign one or more object classes to it. Some of the attributes in these object classes are mandatory and must have values, others are optional and can be empty.

For example, the `organizationalPerson` object class includes the mandatory attributes `commonName (cn)` and `surname (sn)`, and the optional attributes `telephoneNumber`, `uid`, `streetAddress`, and `userPassword`. When you define an entry by using the `organizationalPerson` object class, you must specify values for `commonName (cn)` and `surname (sn)`. You do not need to provide values for `telephoneNumber`, `uid`, `streetAddress`, and `userPassword`.

This section contains these topics:

- [Subclasses, Superclasses, and Inheritance](#)
- [Object Class Types](#)

Subclasses, Superclasses, and Inheritance

A subclass is an object class derived from another object class. The object class from which a subclass is derived is called its superclass. For example, the object class `organizationalPerson` is a subclass of the object class `person`. Conversely, the object class `person` is the superclass of the object class `organizationalPerson`.

Subclasses inherit all of the attributes belonging to their superclasses. For example, the subclass `organizationalPerson` inherits the attributes of its superclass, `person`. Entries also inherit attributes that their superclasses have inherited.

Note: In itself, an object class contains no values. Only an instance of an object class—that is, an entry—contains values. When a subclass inherits attributes from a superclass, it inherits only the attribute definitions of the superclass.

One special object class, called `top`, has no superclasses. It is one of the superclasses of every object class in the directory, and its attribute definitions are inherited by every entry.

Object Class Types

There are three types of object classes:

- Structural
- Auxiliary
- Abstract

Structural Object Classes

Structural object classes describe the basic aspects of an object. Most of the object classes that you use are structural object classes, and every entry should belong to at least one structural object class. Examples of structural object classes are `person` and `groupOfNames`.

These object classes model real-world entities and their physical or logical attributes. Examples include people, printers, and database connections.

Structural object classes use structure rules to place restrictions on the kinds of objects you can create under any given object class. For example, a structure rule might require all objects below the `organization (o)` object class to be `organizational units (ou)`. Following this rule, you could not enter `person` objects directly below an `organization` object class. Similarly, a structure rule might disallow you from placing an `organizational unit (ou)` object below a `person` object.

Auxiliary Object Classes

Auxiliary object classes are groupings of optional attributes that expand the existing list of attributes in an entry. Unlike structural object classes, they do not place restrictions on where an entry may be stored, and you can attach them to any entry regardless of that entry's location in the DIT.

Note: Oracle Internet Directory does not enforce structure rules. It therefore handles both structural and auxiliary object classes in the same way.

Abstract Object Classes

An abstract object class is a virtual object class. It is used only for convenience when specifying the highest levels of the object class hierarchy. It cannot be the only object class for an entry. For example, the object class `top` is an abstract object class. It is required as a superclass for all structural object classes, but it cannot be used alone.

The `top` object class includes the mandatory attribute `objectClass` and several optional attributes. The optional attributes in `top` are:

- `orclGuid`: Global identification which remains constant if the entry is moved
- `creatorsName`: Name of the creator of the object class
- `createTimestamp`: Time when the object class was created
- `modifiersName`: Name of the last person to modify the object class
- `modifyTimestamp`: Time when the object class was last modified
- `orclACL`: access control list (ACL) directives that apply to all entries in the subtree below the access control policy point (ACP) where this attribute is defined
- `orclEntryLevelACL`: Access control policy pertaining to only a specific entity, for example, a special user

See Also:

- ["Globalization Support"](#) on page 3-15 for more information on access control policies and ACLs
- ["Understanding Attributes"](#) on page 20-4 for a discussion of how to add additional content to entries

Naming Contexts

A directory naming context is a subtree that resides entirely on one server. It must be a complete subtree, that is, it must begin at an entry that serves as the top of the subtree, and extend downward to either leaf entries or references to subordinate naming contexts. It can range in size from a single entry to the entire directory information tree (DIT).

Figure 3-5 illustrates correct and incorrect naming contexts. Notice that the correct ones on the left are contiguous, and the incorrect ones on the right are not.

Figure 3-5 *Correct and Incorrect Naming Contexts*

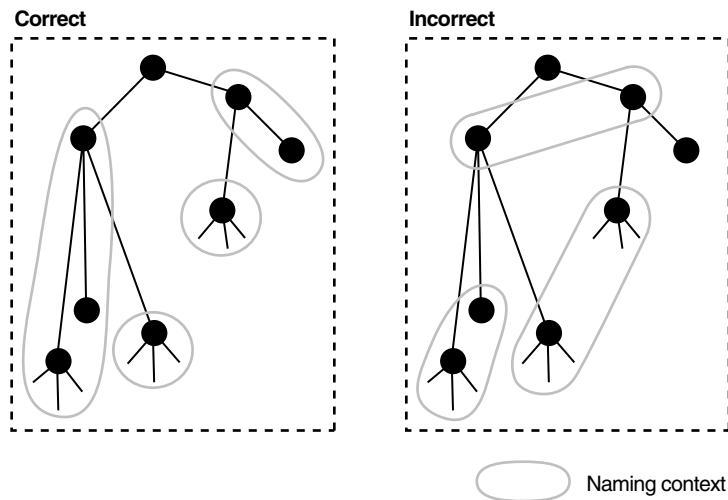

To enable users to discover specific naming contexts, you can publish those naming contexts in Oracle Internet Directory by using ldapmodify.

See Also: [Chapter 11, "Managing Naming Contexts"](#) for instructions on how to publish a naming context

Security

Oracle Internet Directory is a key element of Oracle Identity Management. You can deploy multiple Oracle components to work against a shared instance of Oracle Internet Directory. This sharing allows an enterprise to simplify security management across all applications.

In addition to the role it plays in the Oracle Identity Management infrastructure, Oracle Internet Directory provides many powerful features for protecting information.

Security features within Oracle Internet Directory itself include:

- The Secure Sockets layer: Ensuring that data is not modified, deleted, or replayed during transmission

- Data privacy: Ensuring that data is not inappropriately observed while it is stored in Oracle Internet Directory
- Password policies: Establishing and enforcing rules for how passwords are defined and used
- Authorization: Ensuring that a user reads or updates only the information for which that user has privileges
- Password protection: Ensuring that passwords are not easily discovered by others
- Authentication: Ensuring that the identities of users, hosts, and clients are correctly validated

You can use all these features to enforce a uniform security policy for multiple applications enabled for Oracle Internet Directory, and do so in either an enterprise or hosted environment. You do this by deploying the directory for administrative delegation. This deployment allows, for example, a global administrator to delegate to department administrators access to the metadata of applications in their departments. These department administrators can then control access to their department applications.

You can also use security features of the underlying Oracle Database, such as Transparent Data Encryption and Database Vault, to protect Oracle Internet Directory data.

See Also: [Part III, "Advanced Administration: Security"](#)

Globalization Support

Oracle Internet Directory follows LDAP Version 3 internationalization (I18N) standards. These standards require that the database storing directory data use Unicode Transformation Format 8-bit (UTF-8) character set. With Oracle9i, Oracle added a new UTF-8 character set called AL32UTF8. This database character set supports the latest version of Unicode (3.2), including the latest supplementary characters. This allows Oracle Internet Directory to store the character data of almost any language supported by Oracle Globalization Support. Moreover, although several different application program interfaces are involved in the Oracle Internet Directory implementation, Oracle Internet Directory ensures that the correct character encoding is used with each API.

Globalization Support means support for both single-byte and multibyte characters. A single-byte character is represented by one byte of memory. ASCII text, for example, uses single-byte characters. By contrast, a multibyte character can be represented by more than one byte. Simplified Chinese, for example, uses multibyte characters. An ASCII representation of a simplified Chinese directory entry definition might look like this:

```
dn: o=\274\327\271\307\316\304,c=\303\300\271\372
objectclass: top
objectclass: organization
o: \274\327\271\307\316\304
```

Where the attribute values correspond to an ASCII representation of a simplified Chinese directory entry definition.

By default, the main Oracle Internet Directory components—OID Monitor (OIDMON), OID Control Utility (OIDCTL), Oracle directory server (OIDLDAPD), and Oracle directory replication server (OIDREPLD)—accept only the UTF-8 character set. The Oracle character set name is AL32UTF8.

The Oracle directory server and database tools are no longer restricted to run on a UTF8 database. However, you must ensure that all characters in the client character set are included in the database character set (with same or different character codes) if the database underlying the Oracle Internet Directory server is not AL32UTF8 or UTF8. Otherwise, there may be data loss during LDAP add, delete, modify, or modifydn operations if the client data cannot be mapped to the database character set.

Oracle Directory Services Manager uses Unicode (UTF-16—that is, fixed-width 16-bit Unicode). It can support internationalized character sets.

See Also:

- [Appendix I, "Globalization Support in the Directory"](#)
- *Oracle Database Globalization Support Guide* in the Oracle Database Documentation Library for a detailed discussion of Globalization Support

Distributed Directories

Although an online directory is logically centralized, it can be physically distributed onto several servers. This distribution reduces the work a single server would otherwise have to do, and enables the directory to accommodate a larger number of entries.

A distributed directory can be either replicated or partitioned. When information is replicated, the same naming contexts are stored by more than one server. When information is partitioned, one or more unique, non-overlapping naming contexts are stored on each directory server. In a distributed directory, some information may be partitioned and some may be replicated.

This section contains these topics:

- [Directory Replication](#)
- [Directory Partitioning](#)

Directory Replication

Replication is the process of copying and maintaining the same naming contexts on multiple directory servers. See [Chapter 6, "Understanding Oracle Internet Directory Replication"](#) for a discussion of replication concepts.

Directory Partitioning

Partitioning, in which each directory server stores one or more unique, non-overlapping naming contexts, is another way of distributing directory information.

[Figure 3–6](#) shows a partitioned directory in which some naming contexts reside on different servers.

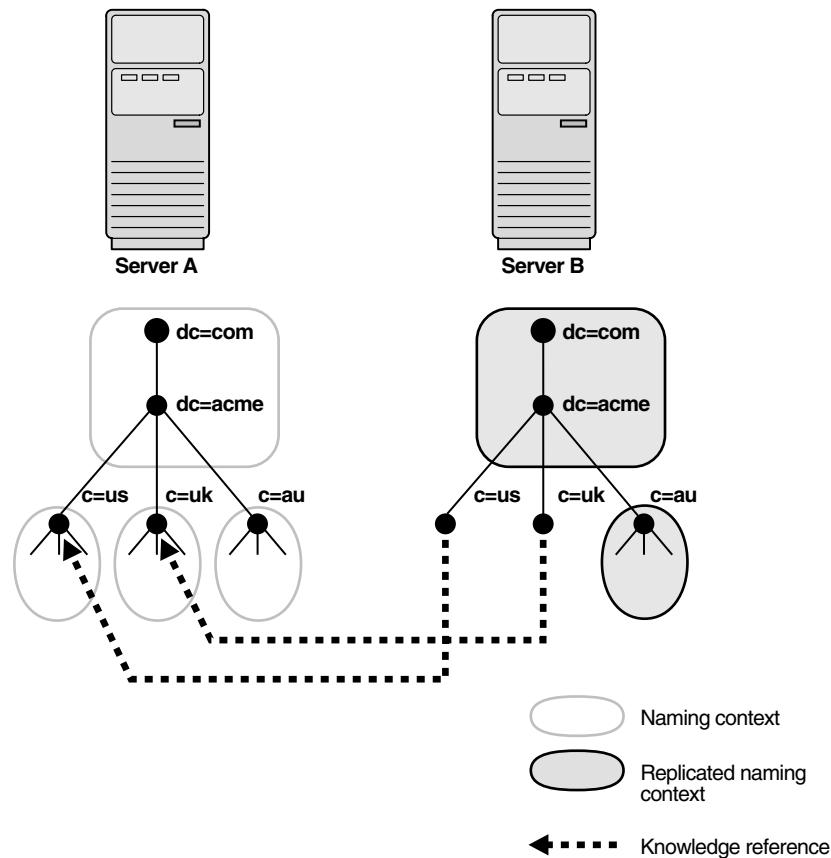
Figure 3-6 A Partitioned Directory

In [Figure 3-6](#) on page 3-17, four naming contexts reside on Server A:

- `dc=acme`, `dc=com`
- `c=us`, `dc=acme`, `dc=com`
- `c=uk`, `dc=acme`, `dc=com`
- `c=au`, `dc=acme`, `dc=com`

Two naming contexts on Server A are replicated on Server B:

- `dc=acme`, `dc=com`
- `c=au`, `dc=acme`, `dc=com`

The directory uses one or more knowledge references to locate information that is requested of Server B, but that resides on Server A. It passes this information to a client in the form of a referral.

Knowledge References and Referrals

A knowledge reference provides the names and addresses of the various naming contexts held in another partition. For example, in [Figure 3-6](#) on page 3-17, Server B uses knowledge references to point to the `c=us` and `c=uk` naming contexts on Server A. When Server B is asked for information residing on Server A, it sends back one or more referrals to Server A. Clients can then use these referrals to contact Server A.

Typically, each directory server contains both superior and subordinate knowledge references. Superior knowledge references point upward in the DIT toward the root.

They tie the partitioned naming context to its parent. Subordinate knowledge references point downward in the DIT to other partitions.

For example, in Figure 3-7 on page 3-18, Server B holds four naming contexts, two of which are superior to the others. These two superior naming contexts use subordinate knowledge references to point to their subordinate naming contexts. Conversely, the naming context on Server A has an immediate superior residing on Server B. Server A therefore uses a superior knowledge reference to point to its parent on Server B.

Figure 3-7 Using Knowledge References to Point to Naming Contexts

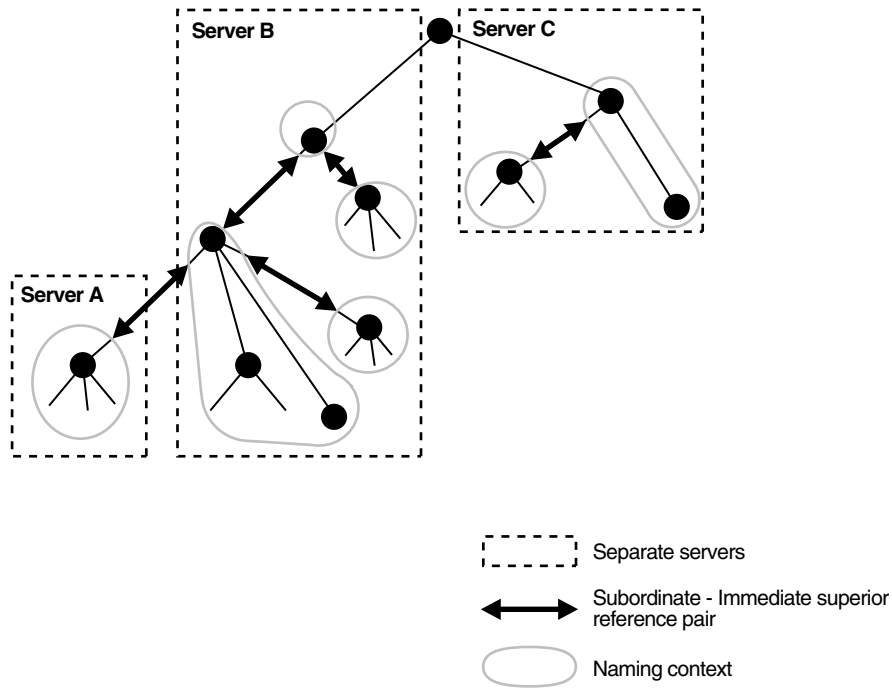

Naming contexts that start at the top of the DIT obviously cannot have a knowledge reference to a superior naming context.

Notes:

- There are presently no Internet standards for enforcing the validity of knowledge references, and Oracle Internet Directory does not do so. It is up to the administrator to ensure consistency among knowledge references within an enterprise network.
 - Oracle recommends that permission for managing knowledge reference entries be restricted, as is the case with any other privileged administrative function such as schema or access control.
-
-

There are two kinds of referrals:

- Smart referrals

These are returned to the client when the knowledge reference entry is in the scope of the search. It points the client to the server that stores the requested information.

For example, suppose that:

- Server A holds the naming context, `ou=server`, `development`, `c=us`, `o=acme`, and has a knowledge reference to Server B.
- Server B holds the naming context `ou=sales`, `c=us`, `o=acme`.

When a client sends a request to Server A for information in `ou=sales`, `c=us`, `o=acme`, Server A provides the user with a referral to Server B.

- Default referrals

These are returned when the base object is not in the directory, and the operation is performed in a naming context on another server. A default referral typically sends the client to a server that has more detailed information about the directory partitioning arrangement.

For example, suppose that Server A holds:

- The naming context `c=us`, `o=acme`
- A knowledge reference to Server PQR that has more knowledge about the overall directory partitioning arrangement

Now suppose that a client requests information on `c=uk`, `o=acme`. When Server A finds that it does not have the `c=uk`, `o=acme` naming context, it provides the client with a referral to Server PQR. From there, the client can find the server holding the requested naming context.

See Also: [Chapter 19, "Managing Knowledge References and Referrals"](#)

Oracle Delegated Administration Services and the Oracle Internet Directory Self-Service Console

Oracle Delegated Administration Services is a set of pre-defined, Web-based units for performing directory operations on behalf of a user. This set of services frees directory administrators from the routine tasks of directory management by enabling them to delegate specific functions to other administrators and to end users. It provides most of the functionality that directory-enabled applications require, such as creating a user entry, creating a group entry, searching for entries, changing user passwords, and other employee-specific data.

Note: All references to Oracle Delegated Administration Services in this chapter refer to Oracle Delegated Administration Services 10g (10.1.4.3.0) or later.

You can use Oracle Delegated Administration Services to develop your own tools for administering application data in the directory. Or you can use the Oracle Internet Directory Self-Service Console, a tool based on Oracle Delegated Administration Services that comes ready-to-use with Oracle Internet Directory. This console is used by several Oracle components to provide delegated administration.

See Also: *Oracle Identity Management Guide to Delegated Administration* in the 10g (10.1.4.0.1) library.

The Service Registry and Service to Service Authentication

The Service Registry and the Service to Service Authentication framework are Oracle Internet Directory features that facilitate integration between Oracle technology

components that request services from one another. The Service Registry provides a place to store information, so that the components can discover each other. The Service to Service Authentication framework allows one component to authenticate to another and establishes trust among them.

The Service Registry is a container in Oracle Internet Directory (under `cn=Services, Cn=OracleContext`) where components store connectivity information, such as protocol, and other information, such as type of service. During installation, each OCS component registers its information in the Registry. At run-time the components discover information registered by other components. Service Registry objects are stored in the Oracle Internet Directory DIT in a component-specific Services container in the `rootOracleContext`.

Service to Service Authentication is a framework that allows one service to authenticate to another and establish trusts among the services. At install time, each of the client services is provisioned with a username and password in Oracle Internet Directory. In addition, each target service defines an authorization role in Oracle Internet Directory to control which components should it trust. When a component requests services of another component, the requestor must authenticate to the target service like any other client, using its own identity and credentials. The requesting service must also be listed in the Target services Trusted Application group (Default Group: `contrasted Applications, counterpoise, cn=OracleContext`). The requesting service also must send the user's identity so that the target service can authenticate the user as well. The data is sent securely, using either Digest authentication or the target service's native secure authentication.

Oracle Directory Integration Platform

Oracle Directory Integration Platform enables an enterprise to integrate its applications and other directories with Oracle Internet Directory. It provides all the interfaces and infrastructure necessary to keep the data in Oracle Internet Directory consistent with that in enterprise applications and connected directories. It also makes it easier for third-party vendors and developers to develop and deploy their own connectivity agents.

For example, an enterprise might want employee records in its HR database to be synchronized with Oracle Internet Directory. In addition, the enterprise may deploy certain LDAP-enabled applications (such as Oracle Portal) that must be notified whenever changes are applied to Oracle Internet Directory.

Based on the nature of integration, Oracle Directory Integration Platform provides two distinct services:

- The synchronization integration service, which keeps connected directories consistent with the central Oracle Internet Directory
- The provisioning integration service, which sends notifications to target applications to reflect changes made to a entries of interest, such as users and groups

See Also: *Oracle Fusion Middleware Administrator's Guide for Oracle Directory Integration Platform*

Oracle Internet Directory and Identity Management

This section contains these topics:

- [About Identity Management](#)

- [Oracle Identity Management Products](#)
- [Identity Management Realms](#)

About Identity Management

Identity management usually refers to the management of an organization's application users. Steps in their security life cycle include account creation, suspension, privilege modification, and account deletion. The managed entities may also include devices, processes, applications, or anything else that must interact in a networked environment. They may also include users outside of the organization, for example customers, trading partners, or Web services.

Identity management is important to IT deployments because it can reduce administrative costs while at the same time improving security.

The Oracle Identity Management products enable deployments to manage centrally and securely all enterprise identities and their access to various applications in the enterprise. Identity management comprises these tasks:

- Creating enterprise identities and managing shared properties of these identities through a single enterprise-wide console
- Creating groups of enterprise identities
- Provisioning these identities in various services available in the enterprise. This includes:
 - Account creation
 - Account suspension
 - Account deletion
- Managing policies associated with these identities. These include:
 - Authorization policies
 - Authentication Policies
 - Privileges delegated to existing identities

Oracle Identity Management Products

The Oracle Identity Management products include the following:

- Oracle Internet Directory, a scalable, robust LDAP Version 3-compliant directory service implemented on the Oracle Database.
- Oracle Virtual Directory, which provides access to multiple data sources without the need to synchronize or move data from its native location. Oracle Virtual Directory can provide multiple application-specific views of identity data and can also be used to secure data access to the application-specific sources and enhance high-availability to existing data-sources.
- Oracle Directory Integration Platform, which permits synchronization between Oracle Internet Directory and other directories and user repositories.
- Oracle Delegated Administration Services, which provides trusted proxy-based administration of directory information by users and application administrators. (Oracle Internet Directory 11g Release 1 (11.1.1) is compatible with Oracle Single Sign-On 10g (10.1.4.3.0) or later.)

- Oracle Single Sign-On, which provides single sign-on access to Oracle and third party web applications. (Oracle Internet Directory 11g Release 1 (11.1.1) is compatible with Oracle Delegated Administration Services 10g (10.1.4.3.0) or later.)
- Oracle Identity Federation, which provides a self-contained federation solution that combines the ease of use and portability of a standalone application with a scalable, standards-based proven interoperable architecture.
- Oracle Identity Manager is a provisioning system for automatically granting and revoking access to enterprise applications and managed systems.
- Oracle Role Manager is an enterprise-class application for managing business and organizational relationships, roles, and entitlements.
- Oracle Enterprise Single Sign-On is an access management system for delivering enterprise authentication and single sign-on for mainframe, client/server and Web applications
- Oracle Access Manager is a management system for configuring digital identities and controlling access to protected applications and content in heterogeneous environments, primarily on the Web.
- Oracle Adaptive Access Manager is the solution for web access real-time fraud detection and multi-factor online authentication security for the enterprise.
- Oracle Entitlements Server, which enables application developers to externalize and centralize fine-grained authorization policies that would previously have been embedded within applications.
- Oracle Authentication Services for Operating Systems, which enables you to centralize storage, authentication, and management of user identities on Linux and UNIX systems using Oracle Internet Directory.

While Oracle Identity Management is designed to provide an enterprise infrastructure for Oracle products, it can also serve as a general-purpose identity management solution for user-written and third-party enterprise applications. It provides a robust and scalable enterprise-wide identity management platform for third-party applications, hardware, and network operating systems. Custom applications can leverage Oracle Identity Management through a set of documented and supported services and APIs, for example:

- Oracle Internet Directory provides LDAP APIs for C, Java, and PL/SQL, and is compatible with other LDAP SDKs.
- Oracle Delegated Administration Services provide a core self-service console that may be customized to support third-party applications. In addition, it provides several services for building customized administration interfaces that manipulate directory data.
- The Oracle Directory Synchronization Service facilitates the development and deployment of custom solutions for synchronizing Oracle Internet Directory with third-party directories and other user repositories.
- The Oracle Directory Integration Platform enables you to provision third-party applications and integrate the Oracle environment with other provisioning systems.
- Oracle Single Sign-On provides APIs for developing and deploying partner applications that share a single sign-on session with other Oracle Web applications.

In addition, Oracle works with third-party application vendors to ensure that their applications can leverage Oracle Identity Management out of the box.

Identity Management Realms

An identity management realm defines an enterprise scope over which certain identity management policies are defined and enforced by the deployment. It comprises:

- A well-scoped collection of enterprise identities—for example, all employees in the US domain.
- A collection of identity management policies associated with these identities. An example of an identity management policy would be to require that all user passwords have at least one alphanumeric character.
- A collection of groups—that is, aggregations of identities—that simplifies the setting of the identity management policies.

You can define multiple identity management realms within the same Oracle Identity Management infrastructure. Multiple realms enable you to isolate user populations and enforce a different identity management policy—for example, password policy, naming policy, self-modification policy—in each realm.

Each identity management realm is uniquely named to distinguish it from other realms. It also has a realm-specific administrator with complete administrative control over the realm.

Default Identity Management Realm

For all Oracle components to function, an identity management realm is required. One particular realm, created during installation of Oracle Internet Directory, is called the default identity management realm. It is where Oracle components expect to find users, groups, and associated policies whenever the name of a realm is not specified.

There can be only one default identity management realm in the directory. If a deployment requires multiple identity management realms, then one of them must be chosen as the default.

Identity Management Policies

The Oracle Identity Management infrastructure supports a flexible set of management policies which comprise:

- Directory structure and naming policies that enable you to:
 - Customize the directory structure in Oracle Internet Directory for your deployment.
 - Specify where various identities are to be located and how they are uniquely identified.
- Authentication policies that enable you to specify authentication methods and protocols supported by the Oracle Identity Management infrastructure
- Identity management authorizations that enable you to control access to certain privileged services and delegate administration wherever necessary

Note: In Oracle Internet Directory Release 9.0.2, the equivalent term for "identity management realm" was "subscriber".

Resource Information

To fulfill the requests of users, some Oracle components gather data from various repositories and services. To gather the data, these components require the following information:

- Information specifying the type of resource from which the data is to be gathered. The type of resource could be, for example, an Oracle Database. This is called resource type information.
- Information for connecting and authenticating users to the resources. This is called resource access information.

This section contains these topics:

- [Resource Type Information](#)
- [Resource Access Information](#)
- [Location of Resource Information in the DIT](#)

Resource Type Information

Information about the resources that an application uses to service a user request is called resource type information. A resource type can be, for example, an Oracle Database or a Java Database Connectivity Pluggable Data Source. Resource type information includes such items as the class used to authenticate a user, the user identifier, and the password.

You specify resource type information by using the Oracle Internet Directory Self-Service Console.

Resource Access Information

Information for connecting and authenticating users to the databases is called resource access information. It is stored in an entry called a resource access descriptor (RAD) from which it can be retrieved and shared by various Oracle components.

For example, to service the request of a user for a sales report, Oracle Reports queries multiple databases. When it does this, it does the following:

1. Retrieves the necessary connect information from the RAD
2. Uses that information to connect to those databases and to authenticate the user requesting the data

After it has done this, it compiles the report.

You specify resource access information by using the Oracle Internet Directory Self-Service Console. You can specify resource access information for each individual user or commonly for all users. In the latter case, all users connecting to a given application use, by default, the same information to connect to the necessary databases. Oracle recommends defining default resource access information whenever an application has its own integrated account management—for example, where each user is defined within the application itself with a unique single sign-on user name.

Location of Resource Information in the DIT

[Figure 3–8](#) shows where resource information is located in the DIT.

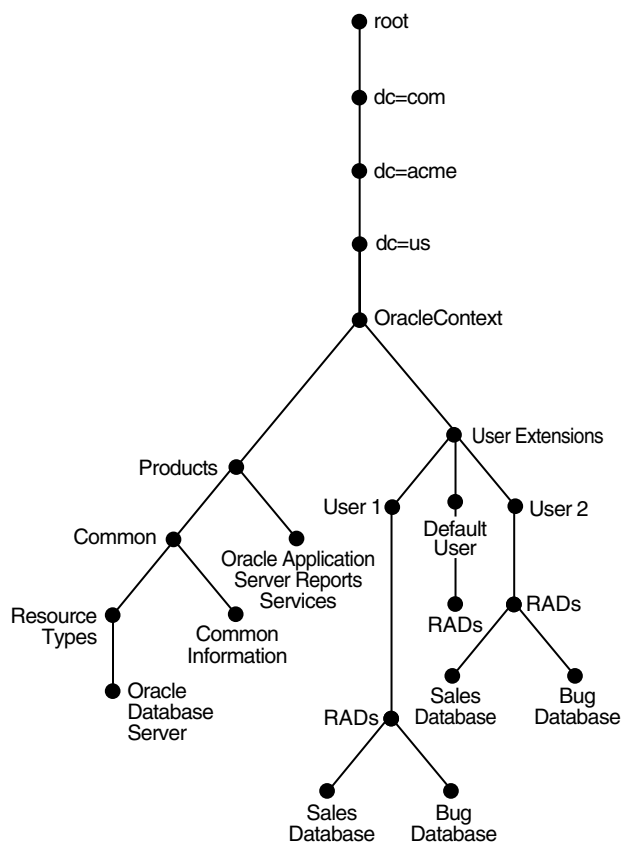
Figure 3–8 Placement of Resource Access and Resource Type Information in the DIT

As [Figure 3–8](#) shows, the resource access and resource type information is stored in the Oracle Context.

Resource access information for each user is stored in the `cn=User Extensions` node in the Oracle Context. In this example, the `cn=User Extensions` node contains resource access information for both the default user and for specific users. In the latter cases, the resource access information includes that needed for accessing both the Sales and the Bug databases.

Resource access information for each application is stored in the object identified by the application name—in this example, `cn=Oracle Reports Services`, `cn=Products`, `cn=Oracle Context`, `dc=us`, `dc=acme`, `dc=com`. This is the user information specific to that product.

Resource type information is stored in the container `cn=resource types`, `cn=common`, `cn=products`, `cn=Oracle Context`.

See Also:

- The sections about managing your own resource information, creating user entries, configuring default resources, and creating new resource types in *Oracle Identity Management Guide to Delegated Administration* in the 10g (10.1.4.0.1) library for instructions for an end user to specify resource access information
- "Plug-in Schema Elements" in *Oracle Fusion Middleware Reference for Oracle Identity Management*
- *Oracle Fusion Middleware Publishing Reports to the Web with Oracle Reports Services*

Understanding Process Control of Oracle Internet Directory Components

This chapter describes the Oracle Internet Directory process control model and related concepts. The process control model applies to the Oracle Internet Directory LDAP server and the replication server.

This chapter contains these topics:

- [Oracle Internet Directory Process Control Architecture](#)
- [The ODS_PROCESS_STATUS Table](#)
- [Starting, Stopping, and Monitoring of Oracle Internet Directory Processes](#)
- [Oracle Internet Directory Process Control–Best Practices](#)

For information on creating and destroying Oracle Internet Directory server instances, see [Chapter 8, "Managing Oracle Internet Directory Instances."](#)

For information on starting and stopping the Oracle Directory Integration and Provisioning server, see the chapter on managing the Oracle Directory Integration and Provisioning server in *Oracle Fusion Middleware Administrator's Guide for Oracle Directory Integration Platform*.

Oracle Internet Directory Process Control Architecture

The Oracle Process Manager and Notification Server (OPMN) is a daemon process that monitors Oracle Fusion Middleware system components, including Oracle Internet Directory. Oracle Enterprise Manager Fusion Middleware Control uses OPMN to stop or start instances of Oracle Internet Directory. If you stop or start Oracle Internet Directory components from the command line, you use `opmnctl`, the command-line interface to OPMN.

See Also:

- [Chapter 8, "Managing Oracle Internet Directory Instances"](#)
- *Oracle Fusion Middleware Oracle Process Manager and Notification Server Administrator's Guide* for more information about the Oracle Process Manager and Notification Server.

OPMN is responsible for the direct start, stop, restart and monitoring of the daemon process, OIDMON (`ORACLE_HOME/bin/oidmon`). OIDMON is responsible for the process control of an Oracle Internet Directory instance. In 11g Release 1 (11.1.1), you can have multiple instances of Oracle Internet Directory on the same Oracle instance on the same node. The recommended way to create a new Oracle Internet Directory

instance is to create an Oracle Fusion Middleware component of type OID. Each Oracle Internet Directory instance created in this manner has its own OIDMON.

Figure 4–1 shows the overall architecture for Oracle Internet Directory process control. For each Oracle Fusion Middleware component of type OID, OPMN spawns an OIDMON process. The figure shows two components, oid1 and oid2. OIDMON spawns the OIDLDPD dispatcher process, then the dispatcher process spawns one or more OIDLDPD server processes. If replication is configured for that instance, OIDMON spawns a replication server process. Each dispatcher process has its own non-SSL and SSL port for receiving requests. The number of OIDLDPD server processes that the dispatcher spawns for a component is controlled by the attribute `orclserverprocs` in the instance-specific configuration entry for the component.

Figure 4–1 Oracle Internet Directory Process Control

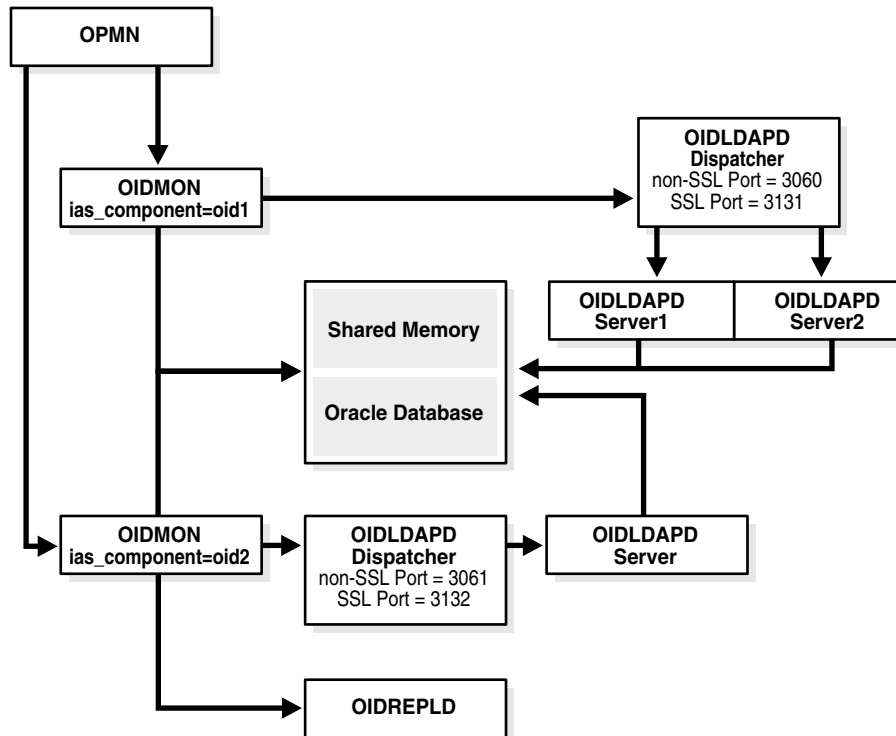

See Also: [Chapter 8, "Managing Oracle Internet Directory Instances"](#) for information about creating new Oracle Internet Directory instances.

The ODS_PROCESS_STATUS Table

Oracle Internet Directory process information is maintained in the ODS_PROCESS_STATUS table in the ODS database user schema. OIDMON reads the contents of the table at a specified interval and acts upon the intent conveyed by the contents of that table. The interval is controlled by the value of the `sleep` command line argument used at OIDMON startup, and the default value is 10 seconds.

Table 4–1 describes the information in the ODS_PROCESS_STATUS table that is relevant to process control:

Table 4–1 Process Control Items in the ODS_PROCESS_STATUS Table

Item	Meaning
Instance	Unique instance number for a given server ID on a given host
PID	Process ID of the server that is up and running
ServerID	Server ID (2=OIDLDAPD, 3=OIDREPLD)
Flags	Command line arguments that must be passed to the server instance
Hostname	Name of the host on which this server must be present
State	State of the Server Instance (0=stop, 1=start, 2=running, 3=restart, 4=shutdown, 5=failed-over, 7=delete, 8=add). OIDMON updates the state.
RetryCount	Number of attempts to start the server instance before it could be started successfully
Instancename	Name of the server instance, for example: server1
Compname	Name of the server component, for example: OID1

Notes:

- There is a uniqueness constraint on: Instance, Instancename, Compname, ServerID, Hostname.
- Details about ODS_PROCESS_STATUS are provided here for informational purposes only. Do not attempt to modify this table directly.

Starting, Stopping, and Monitoring of Oracle Internet Directory Processes

This section describes the events that occur when OPMN starts and stops Oracle Internet Directory. It also describes process monitoring. This section includes the following topics:

- [Oracle Internet Directory Snippet in opmn.xml](#)
- [OPMN Starting Oracle Internet Directory](#)
- [OPMN Stopping of Oracle Internet Directory](#)
- [Process Monitoring](#)

Oracle Internet Directory Snippet in opmn.xml

When OPMN starts OIDMON, it determines what arguments to use based on the Oracle Internet Directory snippet in the OPMN configuration file, `ORACLE_INSTANCE/config/OPMN/opmn/opmn.xml`. The following is a sample Oracle Internet Directory snippet:

```
<ias-component id="<componentName>">
  <process-type id="OID" module-id="OID">
    <process-set id="OID" numprocs="1">
      <environment>
        <variable id="TNS_ADMIN" value="ORACLE_INSTANCE/config" />
        <variable id="DB_CONNECT_STR" value="db_alias" />
      </environment>
    </process-set>
  </process-type>
</ias-component>
```

```
<category id="oidmon-parameters">
  <data id="start-cmdline-opts" value="connect=$DB_CONNECT_STR start"/>
  <data id="stop-cmdline-opts" value="connect=$DB_CONNECT_STR stop"/>
</category>
</module-data>
</process-set>
</process-type>
</ias-component>
```

Two tags are specific to Oracle Internet Directory:

- Oracle Internet Directory component-specific directives for OPMN are located under the tag `<ias-component id="OID" status="enabled">`.
- OIDMON-related requirements are located under the tag `<category id="oidmon parameters">`. There should be only one such directive.

OPMN Starting Oracle Internet Directory

Oracle Internet Directory is started as follows:

- You start an Oracle Internet Directory instance with Oracle Enterprise Manager Fusion Middleware Control or with the command `opmnctl`.

See Also: ["Starting the Oracle Internet Directory Server by Using Fusion Middleware Control"](#) on page 8-5 and ["Starting the Oracle Internet Directory Server by Using opmnctl"](#) on page 8-9

- OPMN issues an `oidmon start` command with appropriate arguments, as specified in the `"oidmon parameters"` in the OID Snippet in `opmn.xml`.
- OIDMON then starts all Oracle Internet Directory Server instances whose information in the `ODS_PROCESS_STATUS` table has `state` value 1 or 4 and `ORACLE_INSTANCE`, `COMPONENT_NAME`, `INSTANCE_NAME` values matching the environment parameters set by OPMN.

Note: When you use `opmnctl` to start only Oracle Internet Directory instances, the `opmn.xml` parameters are not reloaded as they are when you use `opmnctl startall`. Execute `opmnctl reload` to reload the changes in the file `ORACLE_INSTANCE/config/OPMN/opmn/opmn.xml`.

OPMN Stopping of Oracle Internet Directory

Oracle Internet Directory is stopped as follows:

- You stop an Oracle Internet Directory instance with Oracle Enterprise Manager Fusion Middleware Control or with `opmnctl`.

See Also: ["Stopping the Oracle Internet Directory Server by Using Fusion Middleware Control"](#) on page 8-5 and ["Stopping the Oracle Internet Directory Server by Using opmnctl"](#) on page 8-10

- OPMN issues an `oidmon stop`.
- For each row in the `ODS_PROCESS_STATUS` table that matches the environment parameters `ORACLE_INSTANCE`, `COMPONENT_NAME`, and `INSTANCE_`

NAME, the `oidmon stop` command kills OIDMON, OIDLDPD, and OIDREPLD processes and updates the state to 4.

Note: When you use `opmnctl` to start only Oracle Internet Directory instances, the `opmn.xml` parameters are not reloaded as they are when you use `opmnctl startall`. Execute `opmnctl reload` to reload the changes in the file `ORACLE_INSTANCE/config/OPMN/opmn/opmn.xml`.

Process Monitoring

OPMN does not monitor server processes directly. OPMN monitors OIDMON and OIDMON monitors the server processes. The events are as follows:

- When you start OIDMON through OPMN, OPMN starts OIDMON and ensures that OIDMON is up and running.
- If OIDMON goes down for some reason, OPMN brings it back up.
- OIDMON monitors the status of the Oracle Internet Directory dispatcher process, LDAP server processes, and replication server process and makes this status available to OPMN and Fusion Middleware Control. The `opmnctl status` command can show OIDLDPD process PIDS because OIDMON sends OPMN that information.

Oracle Internet Directory Process Control–Best Practices

The recommended approach for using `opmnctl` and `oidctl` is as follows:

- Use `opmnctl` to stop or start Oracle Internet Directory as a component. That is, use it to stop or start all Oracle Internet Directory LDAP and replication server instances.
 - Using `opmnctl` to stop Oracle Internet Directory causes OPMN to issue an `oidmon stop`, which results in OIDMON shutting down all configured LDAP and replication server instances.
 - Using `opmnctl` to start Oracle Internet Directory causes OPMN to issue an `oidmon start`, which results in OIDMON starting up all configured LDAP and replication server instances.

See Also: [Chapter 8, "Managing Oracle Internet Directory Instances"](#)[Chapter 38, "Setting Up Replication"](#) for more information on starting and stopping Oracle Internet Directory.

- Use `oidctl` to stop and start an Oracle Internet Directory Replication Server Instance without affecting the associated OIDMON and LDAP server instance managed by OIDMON.

See Also:

- [Chapter 38, "Setting Up Replication"](#) for more information on starting and stopping a replication server.
- [Appendix B, "Managing Oracle Internet Directory Instances by Using OIDCTL."](#)

Understanding Oracle Internet Directory Organization

This chapter discusses further details to consider when designing the logical organization of directory information. It contains these topics:

- [The Directory Information Tree](#)
- [Planning the Overall Directory Structure](#)
- [Planning the Names and Organization of Users and Groups](#)
- [Migrating a DIT from a Third-Party Directory](#)

The Directory Information Tree

Oracle Internet Directory serves as a shared repository for the entire Oracle Identity Management infrastructure. A carefully planned logical structure of the directory enables:

- Enforcement of security policies that meet the requirements of your deployment
- An efficient physical deployment of the directory service
- Easier configuration of synchronization of a third-party directory with Oracle Internet Directory

[Figure 5–1](#) shows a directory information tree for a hypothetical company, called MyCompany, that is deploying identity management.

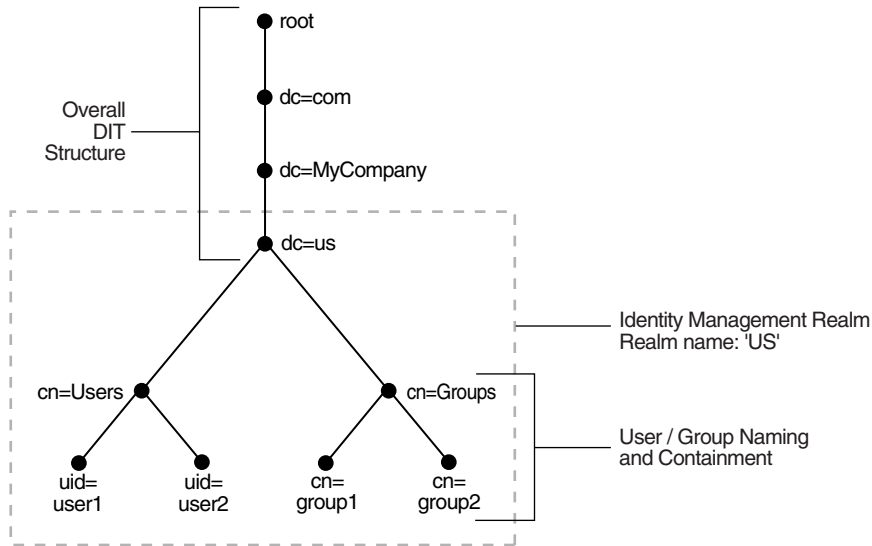
Figure 5–1 Planning the Directory Information Tree

MyCompany makes the following decisions with respect to the logical organization of the directory in their U.S. deployment:

- A domain name-based scheme is to represent the overall DIT hierarchy. Because the identity management infrastructure is being rolled out in the us domain, the root of the DIT is `dc=us`, `dc=mycompany`, `dc=com`.
- Within the naming context chosen, all users are represented under a container called `cn=users`. Within this container, all users are represented at the same level—that is, there is no organization-based hierarchy. In addition, the `uid` attribute is chosen as the unique identifier for all users.
- Within the naming context chosen, all enterprise groups are represented under a container called `cn=groups`. Within this container, all enterprise groups are represented at the same level. The naming attribute for all group entries is `cn`.
- Finally, the container `dc=us` is chosen as the root of the identity management realm. In this case, the name of the realm is `us`. The deployment expects to enforce similar security policies for all users who fall under the scope of the `us` realm.

Planning the logical organization of the directory for Oracle Identity Management involves planning:

- The overall structure of the directory information tree
- The directory containment and naming for users and groups
- The identity management realm

Planning the Overall Directory Structure

This task involves designing the basic directory information tree that all identity management-integrated applications in the enterprise are to use. As you do this, keep these considerations in mind:

- The directory organization should facilitate clean and effective access control. If either full or partial replication is planned, then proper boundaries and policies for replication can be enforced only if the design of the DIT brings out the separation.

- If the enterprise is integrating with a third-party directory server, then it is best to align the DIT design of Oracle Internet Directory with the existing DIT. This consideration also applies to deployments that are rolling out Oracle Internet Directory now but plan to roll out another directory later—for example, Microsoft Active Directory that is required for the operation of software from Microsoft. In each case, choosing an Oracle Internet Directory DIT design that is more consistent with that of the third-party directory makes management of user and group objects easier through Oracle Delegated Administration Services and other middle-tier applications.
- In a single enterprise scenario, choosing a DIT design that aligns with the DNS domain name of the enterprise suffices. For example, if Oracle Internet Directory is set up in a company having the domain name `mycompany.com`, then a directory structure that has `dc=mycompany, dc=com` is recommended. Oracle recommends that you not use departmental or organization level domain components such as `engineering` in `engineering.mycompany.com`.
- If the enterprise has an X.500 directory service, and no other third-party LDAP directories in production, then it may benefit by choosing a country-based DIT design. For example, a DIT design with the root of `o=mycompany, c=US` might be more suitable for enterprises which already have an X.500 directory service.
- Because the directory can be used by several applications—both from Oracle and from third-parties alike—the naming attributes used in relative distinguished names (RDNs) constituting the overall DIT structure should be restricted to well-known attributes. The following attributes are generally well-known among most directory-enabled applications:
 - `c`: The name of a country
 - `dc`: A component of a DNS domain name
 - `l`: The name of a locality, such as a city, county or other geographic region
 - `o`: The name of an organization
 - `ou`: The name of an organizational unit
 - `st`: The name of a state or province
- A common mistake is to design the DIT to reflect either the corporate divisional or organizational structure. Because most corporations undergo frequent reorganization and divisional restructuring, this is not advisable. It is important to insulate the corporate directory from organizational changes as much as possible.

Planning the Names and Organization of Users and Groups

This section offers some things to consider when modeling users and groups in Oracle Internet Directory. Most of the design considerations that are applicable to the overall DIT design are also applicable to the naming and containment of users and groups.

Organizing Users

The Oracle Identity Management infrastructure uses Oracle Internet Directory as the repository for all user identities. Even though a user might have account access to multiple applications in the enterprise, there is only one entry in Oracle Internet Directory representing that user's identity. The location and content of these entries in the overall DIT must be planned before deploying Oracle Internet Directory and other components of the Oracle Identity Management infrastructure.

- As mentioned in the previous section, it is tempting to organize users according to their current departmental affiliations and hierarchy. However, this is not advisable because most corporations undergo frequent reorganization and divisional restructuring. It is more manageable to capture a person's organizational information as an attribute of that person's directory entry.
- There are no performance benefits derived from organizing users in a hierarchy according to organizational affiliations or management chain. Oracle recommends that you keep the DIT containing users as flat as possible.
- If the deployment has different user populations with each one maintained and managed by a different organization, then Oracle recommends subdividing users into containers based on these administrative boundaries. This simplifies the setting of access controls and helps in cases where replication is needed.
- The out-of-the-box default nickname attribute for uniquely identifying users in lookup operations is `uid`. This is the default attribute used for logins. The out-of-the-box default naming attribute for constructing a DN is `cn`.
- The default attribute for uniquely identifying users is `cn` or `CommonName`. The typical value of `CommonName` is the person's full name. People's names or email addresses, however, can change and therefore might not be suitable as values of this attribute. If possible, choose a value that will not change and that uniquely identifies a user, such as the employee id.
- Typically, most enterprises have a Human Resources department that establishes rules for assigning unique names and numbers for employees. When choosing a unique naming component for directory entries, it is good to exploit this administrative infrastructure and use its policies.
- It is required that all user entries created in the directory belong to the following object classes: `inetOrgPerson`, `orclUserV2`.
- If you already have a third-party directory, or plan to integrate with one in the future, then it is beneficial to align the user naming and directory containment in Oracle Internet Directory with the one used in the third-party directory. This simplifies the synchronization and subsequent administration of the distributed directories.

Note: In Oracle Internet Directory Release 9.0.2, the default value for the `nickname` attribute was `cn`. As of Release 9.0.4, the default value for this attribute is `uid`.

Organizing Groups

Some applications integrated with the Oracle Identity Management infrastructure can also base their authorizations on enterprise-wide groups created by the deployment in Oracle Internet Directory. Like user entries, the location and content of these group entries should also be carefully planned. When you design groups, consider the following:

- There are no performance benefits to be gained from organizing enterprise groups in a hierarchy based on the organizational affiliations or ownership. Oracle recommends keeping the DIT that contains groups as flat as possible. This facilitates easy discovery of groups by all applications and fosters sharing of these groups across applications.
- It is preferable to separate the users and groups in the DIT so that different management policies can be applied to each set of entries.

- The attribute used to uniquely identify a group should be `cn` or `CommonName`.
- All group entries created by the enterprise in the directory should belong to the following object classes: `groupOfUniqueNames` and `orclGroup`. The former object class is an internet standard for representing groups. The latter is useful when using the Oracle Internet Directory Self-Service Console to manage groups.
- Instead of creating new directory access controls for each enterprise-wide group, consider doing the following:
 1. Use the `owner` attribute of the group to list which users own this group.
 2. Create an access control policy at a higher level that grants all users listed in the `owner` attribute special privileges to perform the various operations.
- In the `description` attribute, provide information for users to understand the purpose of the group.
- Consider using the `displayName` attribute from the `orclGroup` object class. This attribute enables Oracle Delegated Administration Services and Oracle Internet Directory Self-Service Console to display a more readable name for the group.
- If you have different sets of groups, each of which is maintained and managed by a different organization with its own administrative policies, then sub-divide the groups into containers based on these administrative boundaries. This simplifies the setting of access controls. It also helps when replication is needed.
- If you already have a third-party directory, or plan to integrate with one in the future, then align the group naming and directory containment in Oracle Internet Directory with the one used in the third-party directory. This simplifies the synchronization and subsequent administration of the distributed directories.

Migrating a DIT from a Third-Party Directory

To migrate a DIT from a third-party directory, use the techniques described in [Chapter 36, "Migrating Data from Other Data Repositories"](#) and in *Oracle Fusion Middleware Administrator's Guide for Oracle Directory Integration Platform* for synchronizing with third-party metadirectory solutions and integrating with third-party directories. If you are migrating a DIT from a Microsoft Active Directory environment, also see the chapter on integration with the Microsoft Active Directory Environment. Oracle recommends that you configure the Oracle Internet Directory DIT to be identical to the third-party DIT.

Understanding Oracle Internet Directory Replication

This chapter provides an introduction to Oracle Internet Directory replication. Replication is the process of copying and maintaining the same naming contexts on multiple directory servers. It can improve performance by providing more servers to handle queries and by bringing the data closer to the client. It improves reliability by eliminating risks associated with a single point of failure.

Figure 6-1 shows a replicated directory.

Figure 6-1 A Replicated Directory

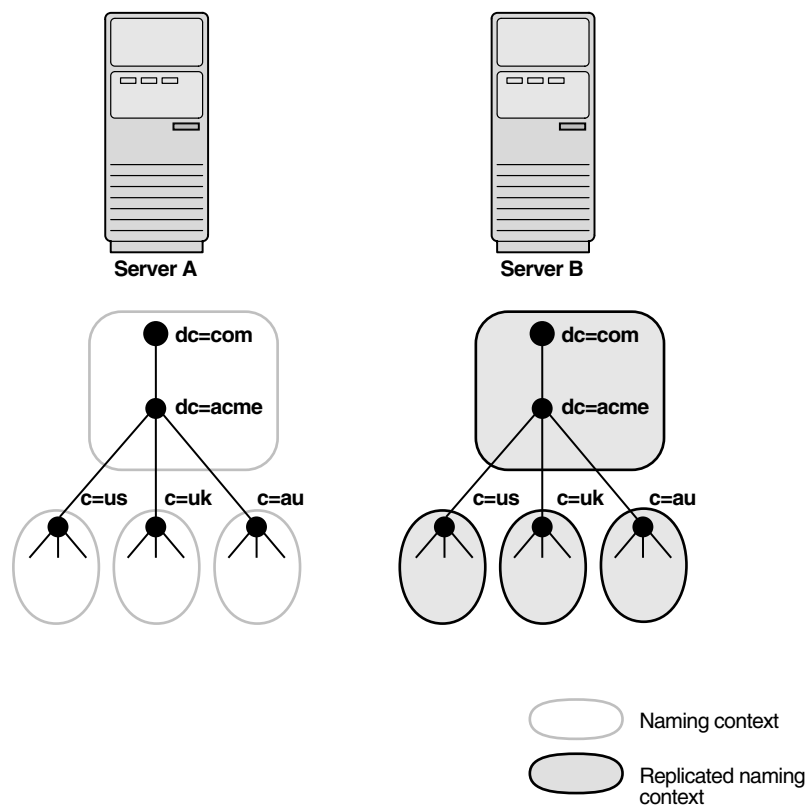

This chapter contains the following topics:

- [Why Use Replication?](#)
- [Replication Concepts](#)

- [What Kind of Replication Do You Need?](#)

See Also:

- [Part V, "Advanced Administration: Directory Replication"](#)
- [Appendix C, "Setting Up Oracle Database Advanced Replication-Based Replication"](#)
- [Appendix D, "How Replication Works"](#)

Why Use Replication?

There are many reasons to implement replication, including the following:

- **Local accessibility and performance requirements**
Most corporations have operations in many regions in the world, and those operations need a common directory. Suppose that the regions were interconnected with low bandwidth links involving multiple intermediate routers. A client accessing a directory server from outside the region could experience a very high latency, and even inadequate throughput. In such cases, a regional replica is essential.
- **Load balancing**
When directory access exceeds the capacity of an existing server, an additional server can share the load. Even if the deployment meets the load, it can be less costly to maintain two relatively low-end systems than one high-end system.
- **Failure tolerance and higher overall system availability**
One of the most important reasons to implement directory replication is to increase overall system availability. When one server is unavailable, the traffic can be routed to other available servers. This can be transparent to clients.

Replication Concepts

This section briefly introduces some basic concepts.

This section contains the following topics:

- [Content to be Replicated: Full or Partial](#)
- [Direction: One-Way, Two-Way, or Peer to Peer](#)
- [Transport Mechanism: LDAP or Oracle Database Advanced Replication](#)
- [Directory Replication Group \(DRG\) Type: Single-master, Multimaster, or Fan-out](#)
- [Loose Consistency Model](#)
- [How the Replication Concepts Fit Together](#)
- [Multimaster Replication with Fan-Out](#)

Content to be Replicated: Full or Partial

One decision you must make when setting up replication is how much of the DIT to replicate from one node to another. The choices are:

Table 6–1 Full or Partial Replication

Content to Replicate	Description
Full	Propagates the entire DIT to another node.
Partial	Propagates one or more subtrees, rather than the entire DIT, to another node.

Full replication involves propagating the entire DIT to another node. This type of replication ensures the high availability of the entire directory. You can also use it to distribute operations on the entire directory among different nodes. Full replication can be based on either LDAP or Oracle Database Advanced Replication.

Partial replication enables you to propagate one or more subtrees, rather than the entire DIT, to another node. Decentralizing a directory in this way enables you to balance the workload between servers and build a highly available distributed directory, complete with fault tolerance and failover. You can set up partial replication by using command-line tools or the Replication Wizard in Oracle Enterprise Manager. Partial replication is most often LDAP-based.

Figure 6–2 shows an example of partial replication.

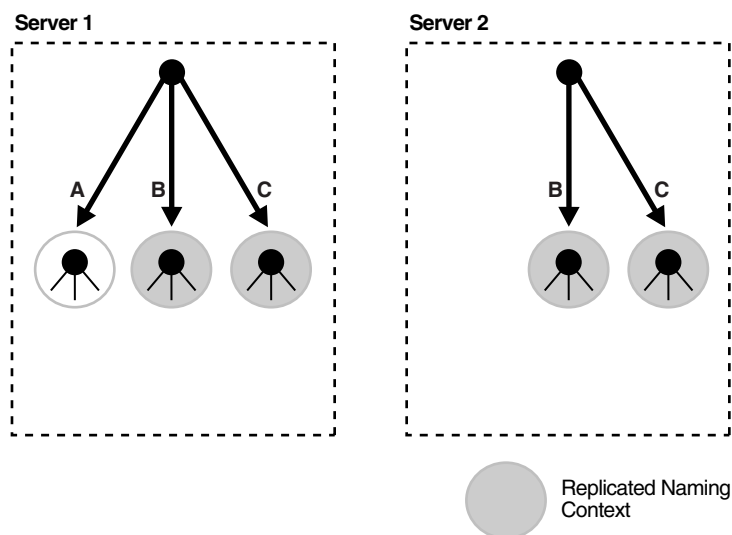
Figure 6–2 Example of Partial Replication

Direction: One-Way, Two-Way, or Peer to Peer

The direction of replication can be one-way, two-way or peer-to-peer:

Table 6–2 Direction of Replication

Direction	Description
One-Way	One node is configured as the supplier and the other as the consumer. The consumer is read-only.
Two-Way	Both nodes are both supplier and consumer. They are both read/write, or updatable.
Peer-to-Peer	All nodes in a replication group are both supplier and consumer to all other nodes

Sometimes the terms read-only and read/write are used to describe direction of replication. In a one-way replication agreement, the consumer node is said to be read-only. That is, you cannot propagate changes to other nodes by writing to that node. In a two-way replication agreement, both nodes are considered to be read/write. Another term for read/write is updatable.

Sometimes the term multimaster is used instead of peer-to-peer. Multimaster actually refers to the type of replication group, as described in "[Directory Replication Group \(DRG\) Type: Single-master, Multimaster, or Fan-out](#)" on page 6-4.

Transport Mechanism: LDAP or Oracle Database Advanced Replication

Oracle Internet Directory supports two protocols you can use for replicating data from one node to another. The protocols are:

Table 6–3 Transport Protocols

Transport Mechanism	Description
LDAP	Uses the industry-standard Lightweight Directory Access Protocol Version 3. This is the recommended protocol to use for replication, unless you are also performing Oracle Single Sign-On replication.
Oracle Database Advanced Replication	Uses the replication feature of Oracle Database. Also called Advanced Replication. This replication protocol is currently required for Oracle Single Sign-On replication.

LDAP replication can be configured as peer-to-peer, one-way or two-way. Advanced Replication is usually peer-to-peer.

Directory Replication Group (DRG) Type: Single-master, Multimaster, or Fan-out

The directory servers that participate in the replication of a given naming context form a directory replication group (DRG). The relationship among the directory servers in a DRG is represented on each node by a special directory entry called a replication agreement. A replication agreement can be either one-way or two-way.

Each copy of a naming context contained within a server is called a replica. A server that sends the updates made to it to other servers is known as a supplier. A server that accepts those changes is called a consumer. A server can be both a supplier and a consumer.

A directory replication group can be single-master, multimaster, or fan-out as described in [Table 6–4](#).

Table 6–4 Types of Directory Replication Groups

Group	Description
Single-master	Has only one supplier replicating changes to one or more consumers. Clients can update only the master node, and can only read data on any of the consumers. This type of group typically uses LDAP. It is also possible to configure Advanced Replication as single-master, by switching all nodes in a group except one to read-only mode.
Multimaster	Enables multiple sites, acting as equals, to manage groups of replicated data. In a multimaster replication environment, each node is both a supplier and a consumer node. Multimaster replication can use either LDAP or Advanced Replication as its transport mechanism. The full DIT is replicated on each node. Replication is always peer-to-peer.

Table 6-4 (Cont.) Types of Directory Replication Groups

Group	Description
Fan-out	Also called a point-to-point replication group, has a supplier replicating directly to a consumer. That consumer can then replicate to one or more other consumers. Fan-out uses LDAP as its transport mechanism. The replication can be either full or partial. It can be either one-way or two-way.

Single-Master Replication Example

Figure 6-3, "Example of Single-Master Replication" shows a single-master replication environment.

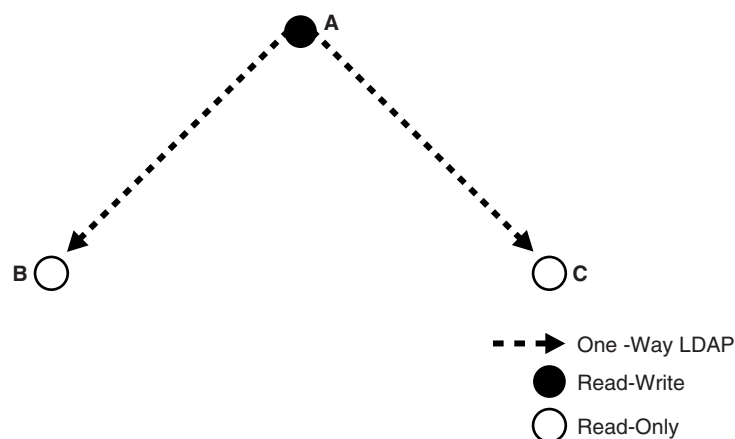
Figure 6-3 Example of Single-Master Replication

In Figure 6-3, each bullet represents a node of Oracle Internet Directory. Node A is a supplier that replicates consumer nodes B and C. Node A is read/write, and Nodes B and C are read-only. The data transfer protocol is LDAP.

Multimaster Replication Example

The example in Figure 6-4 shows three nodes—A, B, and C—that update each other in a multimaster replication group. Replication between nodes is two-way.

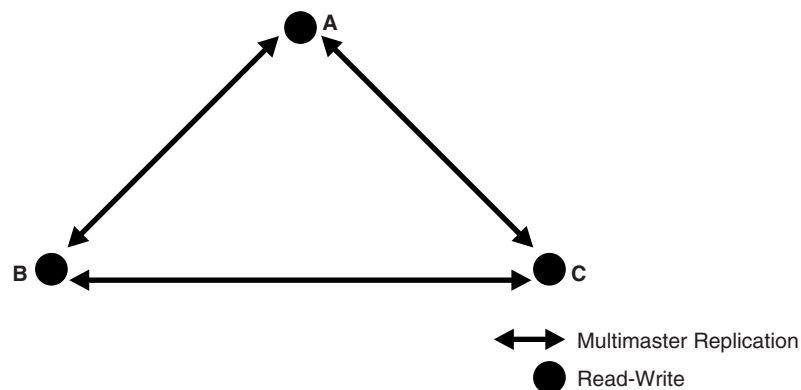
Figure 6-4 Example of Multimaster Replication

In Figure 6-4, all replication is two-way.

Note: Multimaster replication is the only replication mechanism supported in Oracle Single Sign-On, as described in the section "Configuring Oracle Single Sign-On for Replication" in the chapter on high availability in the *Oracle Application Server Single Sign-On Administrator's Guide* in the 10g (10.1.4.0.1) library.

Fan-out Replication Example

Figure 6-5 shows a fan-out replication environment.

Figure 6-5 Example of Fan-Out Replication

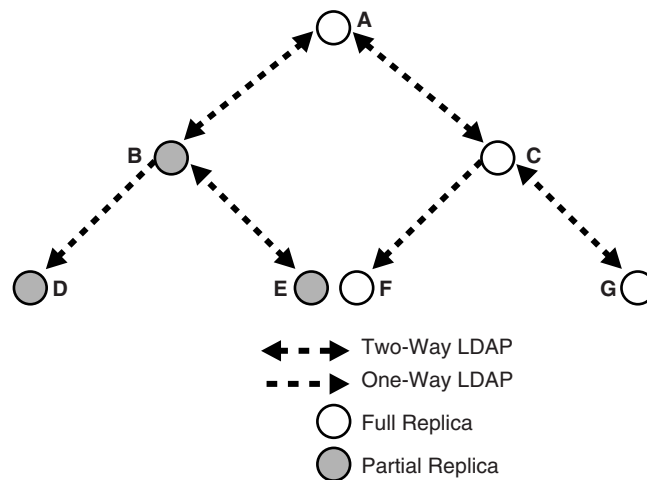

In Figure 6-5, supplier A replicates to two consumers, B and C. Consumer node B contains a partial replica of A, whereas consumer node C contains a full replica of A.

Each of these nodes, in turn, serves as a supplier that replicates data to two other consumers: Node B partially replicates to nodes D and E, and node C fully replicates to nodes F and G. Nodes D and F are read-only.

In fan-out replication, nodes transfer data by using LDAP.

Loose Consistency Model

Directory replication architecture is based on a loose consistency model: Two replicated nodes in a replication agreement are not guaranteed to be consistent in real time. This increases the overall flexibility and availability of the directory network, because a client can modify data without all interconnected nodes being available. Suppose, for example, that one node is unavailable or heavily loaded. With multimaster replication, the operation can be performed on an alternate node, and all interconnected nodes synchronize in due course.

How the Replication Concepts Fit Together

Table 6-5 shows each of the two transport mechanisms, LDAP and Oracle Database Advanced Replication, and describes how each type can be combined with other replication concepts.

Table 6–5 *Types of Data Transfer Between Nodes in a Directory Replication Group*

Concept	LDAP-Based Replication	Oracle Database Advanced Replication-Based Replication
Content replicated	Full replica Partial replica	Full replica (usually)
Direction of replication	Peer-to-peer One-way Two-way	Peer-to-peer
DRG Type	Multimaster replication Single-master replication Fan-out replication	Multimaster replication Single-master replication, by switching all masters in a multimaster configuration except one to read-only mode.

Multimaster Replication with Fan-Out

Oracle Internet Directory enables any node in a multimaster replication group to also participate in a fan-out replication agreement. Within the multimaster replication agreement, data transfer between the nodes occurs by way of Oracle Database Advanced Replication or LDAP. Within the fan-out replication agreement, data transfer from supplier to consumer occurs by way of LDAP and can be either one-way or two-way.

[Figure 6–6](#) shows an example of multimaster replication used with fan-out replication.

Figure 6–6 Example of Multimaster Replication with Fan-Out

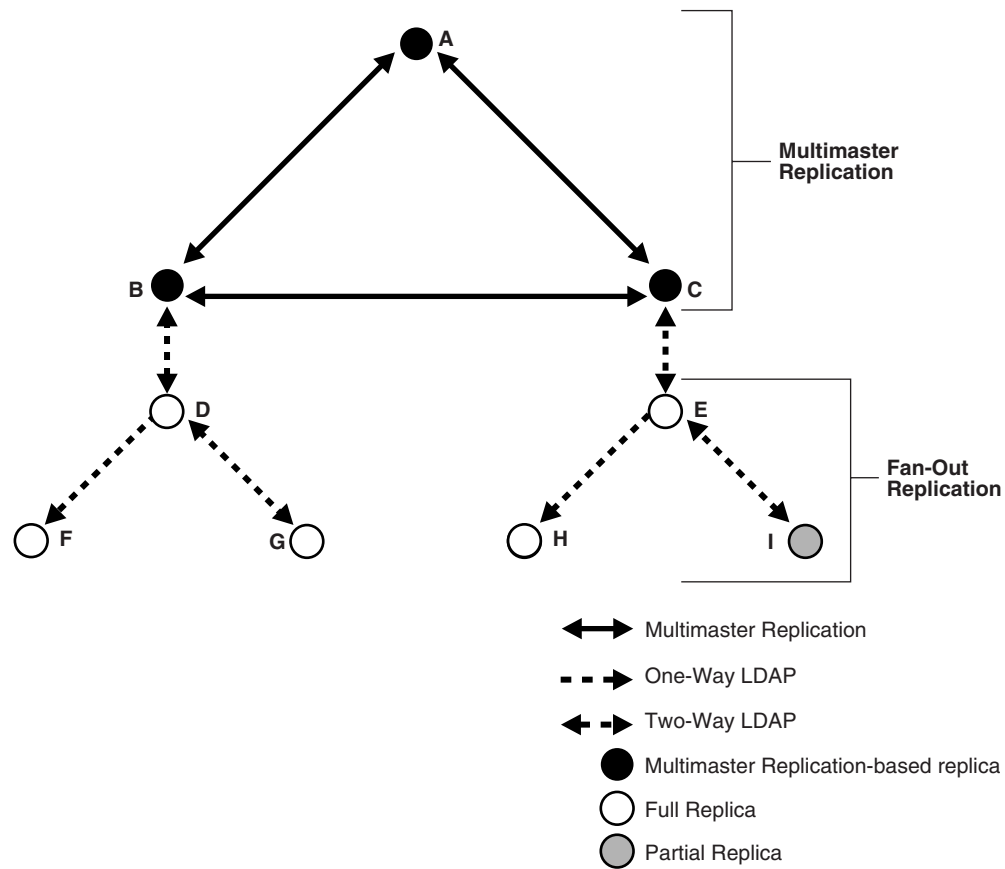

In the example in [Figure 6–6](#), nodes A, B, and C form a multimaster replication group. They transfer data among them by using either LDAP or Advanced Replication.

Node B supplies changes to Node D, a replica of the entire directory. Node D, in turn, supplies changes to Nodes F and G by using LDAP-based replication. Both Nodes F and G are replicas of the entire directory. Similarly, Node E is a full replica of Node C. Node E, in turn supplies changes to Node H, a replica of the entire directory, and Node I, a partial replica, by using LDAP-based replication. Nodes F and H are read-only.

See Also: "LDAP-Based Replication" on page 29-23 for more information about fan-out replication

What Kind of Replication Do You Need?

The type of replication you need depends on the features that are important in your enterprise. This section discusses the types of replication to use to achieve three features: local availability, load balancing, and high availability

Local Availability

Local availability is important in the following situations:

- You need a local copy of the master data that is specific to the local site. This might be the entire DIT or a partial DIT.
- You need the increased scalability and performance that you can get by distributing the work load among multiple servers.

- You want to reduce the network dependency and network load caused by users from local sites connecting to the master site.

If the local site does not update the data, use one-way replication from master node to local nodes

If the local site does need to update the data and the updates must be replicated back to the master site, use two-way replication between master node and local nodes.

Load Balancing

Load Balancing is important in the following situations:

- You want to increase scalability and performance by distributing work load among multiple servers
- You want to dedicate specific servers to certain applications, such as single sign-on or e-mail applications
- You require network load balancing.

You can use LDAP multi-master replication to replicate the data between two or more nodes. If Oracle Single Sign-On10g (10.1.4.3.0) or later is also installed and Oracle Single Sign-On schema must be replicated for load balancing, use Oracle Database Advanced Replication-based multimaster replication. Otherwise, you can use LDAP-based multimaster replication.

Note: When you configure a load balancer for use with replication, use sticky routing and not round-robin routing. Replication is asynchronous in nature, so changes made on one node are not available immediately on the other nodes.

High Availability

High availability is important in the following situations:

- You require a high availability solution with at least one backup server to prevent loss from single server failure
- You need a disaster recovery solution that uses geographically distributed deployments to protect applications from disasters.

Usually, you can use LDAP-based multimaster replication to replicate the data between two or more nodes. If Oracle Single Sign-On 10g (10.1.4.3.0) or later is also installed along with Oracle Internet Directory, however, then use Oracle Database Advanced Replication-based multimaster replication.

Part II

Basic Administration

This part guides you through common Oracle Internet Directory configuration and maintenance tasks. This part contains these chapters:

- [Chapter 7, "Getting Started With Oracle Internet Directory"](#)
- [Chapter 8, "Managing Oracle Internet Directory Instances"](#)
- [Chapter 9, "Managing System Configuration Attributes"](#)
- [Chapter 10, "Managing IP Addresses"](#)
- [Chapter 11, "Managing Naming Contexts"](#)
- [Chapter 12, "Managing Accounts and Passwords"](#)
- [Chapter 13, "Managing Directory Entries"](#)
- [Chapter 14, "Managing Dynamic and Static Groups"](#)
- [Chapter 15, "Performing Bulk Operations"](#)
- [Chapter 16, "Managing Collective Attributes"](#)
- [Chapter 17, "Managing Alias Entries"](#)
- [Chapter 18, "Managing Attribute Uniqueness Constraint Entries"](#)
- [Chapter 19, "Managing Knowledge References and Referrals"](#)
- [Chapter 20, "Managing Directory Schema"](#)
- [Chapter 21, "Configuring Referential Integrity"](#)
- [Chapter 22, "Managing Auditing"](#)
- [Chapter 23, "Managing Logging"](#)
- [Chapter 24, "Monitoring Oracle Internet Directory"](#)
- [Chapter 25, "Backing Up and Restoring Oracle Internet Directory"](#)

Getting Started With Oracle Internet Directory

This chapter assumes you have installed and configured Oracle Internet Directory as described in: *Oracle Fusion Middleware Installation Guide for Oracle Identity Management*. This chapter describes the management interfaces and documents the first tasks you must perform as an administrator of Oracle Internet Directory.

It contains the following sections:

- [Patching Your System to 11g Release 1 \(11.1.1.4.0\)](#)
- [Postinstallation Tasks and Information](#)
- [Using Fusion Middleware Control to Manage Oracle Internet Directory](#)
- [Using Oracle Directory Services Manager](#)
- [Using Command-Line Utilities to Manage Oracle Internet Directory](#)
- [Basic Tasks for Configuring and Managing Oracle Internet Directory](#)

Patching Your System to 11g Release 1 (11.1.1.4.0)

To patch an existing system to 11g Release 1 (11.1.1.4.0), follow the procedures in *Oracle Fusion Middleware Patching Guide*. In addition, perform the following tasks:

Deselecting Cipher Suites for SSL Server Authentication

If you have SSL server authentication enabled and cipher suites configured, deselect the configured cipher suites before patching your system. You can do this by using Oracle Enterprise Manager Fusion Middleware Control, as described in "[Configuring SSL Parameters by Using Fusion Middleware Control](#)" on page 26-7. If you do not deselect the cipher suites before patching, you will be unable to use Oracle Enterprise Manager Fusion Middleware Control or WLST after patching.

If you discover this problem after patching, remove the `orclsslcpiphersuite` attribute from the instance-specific configuration entry by using `ldapmodify`. The LDIF file for deleting the `orclsslcpiphersuite` attribute in the instance-specific entry is:

```
dn: cn=componentname,cn=osldlapd,cn=subconfigsentry
changetype: modify
replace: orclsslcpiphersuite
orclsslcpiphersuite: negotiateit
```

The command is:

```
ldapmodify -D cn=orcladmin -q -p portNum -h hostname -f ldifFile
```

Restart Oracle Internet Directory as described in ["Restarting the Oracle Internet Directory Server by Using opmnctl"](#) on page 8-10.

Upgrading a Directory Replication Group

If replication is configured in your existing Oracle Internet Directory environment, you must follow the procedure in [Appendix Q, "Performing a Rolling Upgrade."](#)

Postinstallation Tasks and Information

Perform these tasks after you complete installation and basic configuration of Oracle Internet Directory.

- [Setting Up the Environment](#)
- [Starting and Stopping the Oracle Stack](#)
- [Identifying Default URLs and Ports](#)
- [Tuning Oracle Internet Directory](#)
- [Enabling Anonymous Binds](#)
- [Enabling Oracle Internet Directory to run on Privileged Ports](#)
- [Verifying Oracle Database Time Zone](#)

Setting Up the Environment

Set the environment variables described at the beginning of ["Using Command-Line Utilities to Manage Oracle Internet Directory"](#) on page 7-13.

Starting and Stopping the Oracle Stack

See [Appendix P, "Starting and Stopping the Oracle Stack"](#) for information.

Identifying Default URLs and Ports

This section lists some default URLs and ports:

URL or Port	Default Value
Oracle Directory Services Manager (ODSM)	<code>http://host:7005/odsm</code>
Oracle Enterprise Manager Fusion Middleware Control	<code>http://host:7001/em/</code>
Oracle WebLogic Server Administrative Console	<code>http://host:7001/console/</code>
Oracle Internet Directory LDAP	3060
Oracle Internet Directory LDAPS	3131

Tuning Oracle Internet Directory

The default Oracle Internet Directory configuration must be tuned in almost all deployments. You must change the values of the certain configuration attributes, based on your deployment. See the "Basic Tuning Recommendations" section of the Oracle Internet Directory chapter in *Oracle Fusion Middleware Performance and Tuning*

Guide especially the tables "Minimum Values for Oracle Database Instance Parameters" and "LDAP Server Attributes to Tune."

For more information about tuning, see the Oracle Internet Directory chapter in *Oracle Fusion Middleware Performance and Tuning Guide*. For descriptions of all the attributes, see [Chapter 9, "Managing System Configuration Attributes"](#) and [Chapter 40, "Managing Replication Configuration Attributes."](#)

Enabling Anonymous Binds

Anonymous searches, except those on the root DSE, are disabled by default. In some deployment environments, clients might need access to more than the root DSE. If you have such a deployment, set the `orclanonymousbindsflag` attribute to 1. See ["Managing Anonymous Binds"](#) on page 32-8 for more information.

See Also: *Oracle Database Net Services Administrator's Guide*

Enabling Oracle Internet Directory to run on Privileged Ports

On many operating systems, only processes running with superuser privilege can use port numbers less than 1024. By default, Oracle Identity Management 11g Installer does not assign privileged ports to Oracle Internet Directory, although you can override the default by using `staticports.ini`. (See *Oracle Fusion Middleware Installation Guide for Oracle Identity Management*.)

If you want to change the SSL and non-SSL ports to numbers in the privileged range after installation, proceed as follows:

1. As the `root` user, execute `ORACLE_HOME/oidRoot.sh`.
2. Reassign the port numbers in one of the following ways:
 - Change the **SSL Port** and **Non-SSL Port** values on the General tab of the Server Properties page in Oracle Enterprise Manager Fusion Middleware Control, as described in ["Configuring Server Properties"](#) on page 9-11.
 - Change the values of `orclnonsslport` and `orclsslport` in the instance-specific configuration entry by using `ldapmodify`, as described in ["Setting System Configuration Attributes by Using ldapmodify"](#) on page 9-16.
3. If you changed the ports by using the command line, run `opmnctl updatecomponentregistration`, as described in ["Updating the Component Registration of an Oracle Instance by Using opmnctl"](#) on page 8-8. (This step is not necessary if you are running a standalone instance of Oracle Internet Directory, as described in ["Creating Additional Oracle Internet Directory Instances"](#) on page 8-3.)
4. Restart Oracle Internet Directory, as described in ["Restarting the Oracle Internet Directory Server by Using Fusion Middleware Control"](#) on page 8-5 or ["Restarting the Oracle Internet Directory Server by Using opmnctl"](#) on page 8-10.

Verifying Oracle Database Time Zone

To ensure that the Oracle Internet Directory garbage collection logic works correctly, verify the Oracle Database `dbtimezone` parameter, as described in ["Set Oracle Database Time Zone for Garbage Collection"](#) on page 35-6.

Using Fusion Middleware Control to Manage Oracle Internet Directory

Oracle Enterprise Manager Fusion Middleware Control is a graphical user interface that provides a comprehensive systems management platform for Oracle Fusion Middleware. Fusion Middleware Control organizes a wide variety of performance data and administrative functions into distinct, Web-based home pages for the domain, Oracle instances, middleware system components, and applications.

Notes:

- If you selected **Configure Without a Domain** when prompted for a domain while installing Oracle Internet Directory, Oracle Enterprise Manager Fusion Middleware Control will not be available.
 - Oracle Enterprise Manager Fusion Middleware Control manages Oracle Internet Directory through its SSL port. The Oracle Internet Directory SSL port must be configured for no authentication or server authentication. If the Oracle Internet Directory SSL port is configured for mutual authentication, you will not be able to change Oracle Internet Directory parameters by using Oracle Enterprise Manager Fusion Middleware Control. See "[SSL Authentication Modes](#)" on page 26-3.
 - For information about supported browsers for Fusion Middleware Control and Oracle Directory Services Manager, refer to System Requirements and Supported Platforms for Oracle Fusion Middleware 11gR1, which is linked from: <http://www.oracle.com/technetwork/middleware/ias/downloads/fusion-certification-100350.html>
-
-

Oracle Internet Directory is a target type in Oracle Enterprise Manager Fusion Middleware Control. To use the interface to Oracle Internet Directory:

1. Connect to Fusion Middleware Control.

The URL is of the form:

`https://host:port/em`

2. In the left panel topology tree, expand the domain, then Fusion Middleware, then Identity and Access. Alternatively, from the domain home page, expand Fusion Middleware, then Identity and Access. Instances of Oracle Internet Directory are listed in both places. To view the full name of a component instance, move the mouse over the instance name.
3. Select the Oracle Internet Directory component you want to manage.
4. Use the Oracle Internet Directory menu to select tasks.

You can use the Oracle Internet Directory menu to navigate to other Fusion Middleware Control pages for Oracle Internet Directory, navigate to Oracle Directory Services Manager pages for Oracle Internet Directory, and perform other tasks, as described in [Table 7-1](#).

Table 7-1 Using the Oracle Internet Directory Menu

Task	Select
Return to Home page	Home

Table 7–1 (Cont.) Using the Oracle Internet Directory Menu

Task	Select
View a performance summary	Monitoring , then Performance
Start, stop, or restart the Oracle Internet Directory component	Control , then Start Up , Shut Down , or Restart , respectively.
View Oracle Internet Directory logs	Logs , then View Log Messages
View non-SSL and SSL port information.	Port Usage
Manage properties that are specific to this Oracle Internet Directory component	Administration , then Server Properties
Manage properties that are shared by all Oracle Internet Directory components that are connected to the same Oracle Database	Administration , then Shared Properties
Set up replication	Administration , then Replication Management
Get tuning and sizing recommendations,	Administration , then Tuning and Sizing
Manage Oracle Internet Directory entries by using Oracle Directory Services Manager	Directory Services Manager , then Data Browser
Manage the Oracle Internet Directory schema by using Oracle Directory Services Manager	Directory Services Manager , then Schema
Manage Oracle Internet Directory security by using Oracle Directory Services Manager	Directory Services Manager , then Security
Manage Oracle Internet Directory advanced features by using Oracle Directory Services Manager	Directory Services Manager , then Advanced
Configure auditing for Oracle Internet Directory	Security , then Audit Policy Settings
Create wallets for Oracle Internet Directory	Security , then Wallets
View target name, software version, Oracle home, Oracle instance, Oracle Enterprise Manager Fusion Middleware Control agent, and host	General Information .

See Also:

- *Oracle Enterprise Manager Concepts*
- *Oracle Enterprise Manager Advanced Configuration*
- *Oracle Fusion Middleware Installation Guide for Oracle Identity Management*

Using Oracle Directory Services Manager

This section contains the following topics:

- [Introduction to Oracle Directory Services Manager](#)
- [Configuring ODSM for SSO Integration](#)
- [Configuring the SSO Server for ODSM Integration](#)
- [Configuring the Oracle HTTP Server for ODSM-SSO Integration](#)
- [Invoking Oracle Directory Services Manager](#)

- [Connecting to the Server from Oracle Directory Services Manager](#)
- [Configuring Oracle Directory Services Manager Session Timeout](#)
- [Configuring Oracle HTTP Server to Support Oracle Directory Services Manager in an Oracle WebLogic Server Cluster](#)

See Also: [Appendix O, "Managing Oracle Directory Services Manager's Java Key Store."](#)

Introduction to Oracle Directory Services Manager

Oracle Directory Services Manager is a web-based interface for managing instances of Oracle Internet Directory and Oracle Virtual Directory. It is a replacement for Oracle Directory Manager, which is now deprecated. Oracle Directory Services Manager enables you to configure the structure of the directory, define objects in the directory, add and configure users, groups, and other entries. ODSM is the interface you use to manage entries, schema, security, and other directory features.

You can also use ODSM to manage system configuration attributes, which can be useful if Fusion Middleware Control is not available or if you must modify an attribute that has no Fusion Middleware Control interface. See ["Managing System Configuration Attributes by Using ODSM Data Browser"](#) on page 9-18 and ["Managing Entries by Using Oracle Directory Services Manager"](#) on page 13-1.

Using the JAWS Screen Reader with Oracle Directory Services Manager

When you use JAWS with ODSM, whenever a new window pops up, JAWS reads "popup." To read the entire page, enter the keystrokes Insert+b.

Non-Super User Access to Oracle Directory Services Manager

Oracle Directory Services Manager allows you to connect to Oracle Internet Directory as any user with a valid DN and password in the directory. If you connect as the super user, `cn=orcladmin`, or as a user who is a member of `cn=DirectoryAdminGroup, cn=oracle internet directory`, you can access all the tabs in the interface. If you log in as any other user, you can access only the Home and Data Browser tabs.

Single Sign-On Integration with Oracle Directory Services Manager

You can configure Oracle Directory Services Manager to use Single Sign-On (SSO). When configured with SSO, Oracle Directory Services Manager allows a user who has been authenticated by the SSO server to connect to an SSO-enabled directory without logging in, provided that user has privileges to manage the directory.

Oracle Directory Services Manager maintains a list of Oracle Virtual Directory servers that SSO-authenticated users can manage. To validate whether an SSO-authenticated user has the required privileges to manage Oracle Virtual Directory, Oracle Directory Services Manager maps the SSO-authenticated user to a DN in the Oracle Virtual Directory server.

Oracle Directory Services Manager uses proxy authentication to connect to the directory. The proxy user's DN and password are stored in a secure storage framework called the Credential Store Framework (CSF).

To map an SSO-authenticated user, Oracle Directory Services Manager authenticates to the Oracle Virtual Directory server using the credentials of a user with proxy privileges. Oracle Directory Services Manager then tries to map the SSO-authenticated user's unique identifier to the Oracle Virtual Directory user's unique identifier.

The WLS Administrator configures the proxy user's credentials, unique identifier attribute, and the base DN under which Oracle Directory Services Manager searches for the user, which are stored in the CSF. If Oracle Directory Services Manager gets a valid DN, it maps the SSO-authenticated user to that DN. When the SSO-authenticated user is mapped to a valid DN, Oracle Directory Services Manager uses proxy authentication to connect to the Oracle Virtual Directory server with the SSO-authenticated user's mapped DN.

To configure SSO integration, see the following sections:

- ["Configuring ODSM for SSO Integration"](#) on page 7-7
- ["Configuring the SSO Server for ODSM Integration"](#) on page 7-8
- ["Configuring the Oracle HTTP Server for ODSM-SSO Integration"](#) on page 7-9.

Configuring ODSM for SSO Integration

To configure ODSM-SSO integration, use the ODSM Proxy Bind Configuration Screen, at `http://host:port/odsm-config`. Log in as the WebLogic administrator.

On this screen, you provide Oracle Directory Services Manager with the set of directory servers that SSO users can manage. This screen lists the Single Sign-On accessible directories.

Use the **View** list to modify the number and order of the columns. To remove an existing directory, click **Remove**.

To modify an existing directory, click **Modify**.

To add a new Single Sign-On accessible directory, click **Add**.

When you click **Modify** or **Add**, the **Directory Details** screen appears. Proceed as follows:

1. Select **Non-SSL** or **SSL** from the **Port Type** list.
2. Select **OID** or **OVD** from the **Directory Type** list.
3. Provide the following information:
 - **Host** and **Port** of the directory.
 - **Proxy User's DN** and **Password**: The DN and password that Oracle Directory Services Manager uses for proxy authentication.
 - **User Container DN**: The DN under which user entries are located in the directory.
 - **User Lookup Attribute**: A unique attribute for looking up a user's DN in the directory. For example, if the SSO server sends the user's mail ID to Oracle Directory Services Manager as the user's unique identifier, you can configure **mail** as the user look-up attribute.
4. Click **Validate** to verify your directory connection details.
Oracle Directory Services Manager authenticates to the directory server with the credentials provided.
5. Click **Apply** to apply your selections.
Click **Revert** to abandon your selections.
6. Specify the SSO server's Logout URL in the SSO Logout URL text box.

For example, `http://myoamhost.mycompany.com:14100/oam/server/logout` is the default Logout URL for the Oracle Access Manager 11g server. If you only configure this field, Oracle Directory Services Manager displays the Login link at the top right corner of the Oracle Directory Services Manager page.

Configuring the SSO Server for ODSM Integration

To make SSO-ODSM integration work correctly, you must configure specific ODSM URLs as protected or unprotected.

ODSM's home page must be an unprotected URL. That is, all users must be able to access the ODSM home page, including those who have not gone through the SSO authentication process.

The URL `/odsm/odsm-ssso.jsp` must be protected by the SSO server. When a user clicks the **Login** link appearing on the top right corner of the home page, ODSM redirects the user to `/odsm/odsm-ssso.jsp`. The SSO server challenges the user for a username and password, if the user is not already authenticated. Upon successful authentication, the user is directed back to the ODSM home page.

You must configure `/odsm/odsm-ssso.jsp` as a protected URL. In addition you must configure the following URLs as unprotected URLs:

- `/odsm/faces/odsm.jspx`
- `/odsm/.../`

You can use either Oracle Access Manager 11g or Oracle Access Manager 10g as your SSO provider.

To configure Oracle Access Manager 11g, see "Deploying the OAM 11g SSO Solution" in *Oracle Fusion Middleware Application Security Guide*.

You must configure an Oracle Access Manager server to send the SSO-authenticated user's unique identifier through an HTTP header to Oracle Directory Services Manager. Oracle Directory Services Manager looks for the `OAM_REMOTE_USER` HTTP header. The Oracle Access Manager server sets the `OAM_REMOTE_USER` header by default. If this header is not available, Oracle Directory Services Manager looks for the `odsm-ssso-user-unique-id` HTTP header. If Oracle Directory Services Manager cannot find any of these headers, Oracle Directory Services Manager SSO integration will not work.

In addition to sending the user's unique identifier through HTTP header, you can optionally configure Oracle Access Manager to send following HTTP headers:

- Configure the `odsm-ssso-user-firstname` HTTP header to send the user's first name.
- Configure the `odsm-ssso-user-lastname` HTTP header to send the user's last name.

If these headers are available, Oracle Directory Services Manager displays the user's first name and last name in the "Logged in as" section located in the top right corner of Oracle Directory Services Manager. If the first name or the last name is not available, Oracle Directory Services Manager displays the user's unique identifier in the "Logged in as" section.

To configure Oracle Access Manager 11g, see "Deploying the OAM 11g SSO Solution" in *Oracle Fusion Middleware Application Security Guide*.

To configure Oracle Access Manager 10g, see "Deploying SSO Solutions with OAM 10g" in *Oracle Fusion Middleware Application Security Guide*.

Configuring the Oracle HTTP Server for ODSM-SSO Integration

If you are using Oracle HTTP Server to host the SSO server's WebGate agent and as a front end to the WebLogic server hosting ODSM, you must configure Oracle HTTP Server's `mod_wl_ohs` module to forward all requests starting with `/odsm` to the WebLogic server hosting ODSM. The `mod_wl_ohs` module allows requests to be proxied from Oracle HTTP Server to Oracle WebLogic Server.

To configure `mod_wl_ohs`, see "Configuring the `mod_wl_ohs` Module" in *Oracle Fusion Middleware Administrator's Guide for Oracle HTTP Server*.

Invoking Oracle Directory Services Manager

You can invoke Oracle Directory Services Manager directly or from Oracle Enterprise Manager Fusion Middleware Control.

Notes:

- If you selected **Configure Without a Domain** when prompted for a domain while installing Oracle Internet Directory, Oracle Directory Services Manager will not be available.
 - For information about supported browsers for Fusion Middleware Control and Oracle Directory Services Manager, refer to System Requirements and Supported Platforms for Oracle Fusion Middleware 11gR1, which is linked from:
<http://www.oracle.com/technetwork/middleware/ias/downloads/fusion-certification-100350.html>
-
-

- To invoke Oracle Directory Services Manager directly, enter the following URL into your browser's address field:

```
http://host:port/odsm
```

In the URL to access Oracle Directory Services Manager, *host* is the name of the managed server where Oracle Directory Services Manager is running. *port* is the managed server port number from the WebLogic server. You can determine the exact port number by examining the `$Fusion_Middleware_Home/Oracle_Identity_Management_domain/servers/wls_ods/data/nodemanager/wls_ods1.url` file, where *Fusion_Middleware_Home* represents the root directory where Fusion Middleware is installed.

- To invoke Oracle Directory Services Manager from Fusion Middleware Control, select **Directory Services Manager** from the Oracle Internet Directory menu in the Oracle Internet Directory target, then **Data Browser**, **Schema**, **Security**, or **Advanced**. (You can connect from the Oracle Virtual Directory menu in a similar manner.)

A new browser window, containing the ODSM Welcome screen, pops up. Connect to the server as described in the next section.

See Also: "[Troubleshooting Oracle Directory Services Manager](#)" on page R-30.

Connecting to the Server from Oracle Directory Services Manager

When the ODSM Welcome screen appears, you can connect to either an Oracle Internet Directory server or a Oracle Virtual Directory server.

This section contains the following topics:

- [Logging in to the Directory Server from Oracle Directory Services Manager](#)
- [Logging Into the Directory Server from Oracle Directory Services Manager Using SSL](#)

Notes:

- After you have logged into ODSM, you can connect to multiple directory instances from the same browser window.
 - Avoid using multiple windows of the same browser program to connect to different directories at the same time. Doing so can cause a `Target unreachable` error.
 - You can log in to the same ODSM instance from different browser programs, such as Internet Explorer and Firefox, and connect each to a different directory instance.
 - If you change the browser language setting, you must update the session in order to use the new setting. To update the session, either reenter the ODSM URL in the URL field and press **Enter** or quit and restart the browser.
-
-

Logging in to the Directory Server from Oracle Directory Services Manager

You log in to a directory server's non-SSL port from Oracle Directory Services Manager as follows:

1. Click the small arrow to the right of the label **Click to connect to a directory**. It opens a dialog box containing the following sections:
 - Live Connections—current connections that you can return to.
 - Disconnected Connections—a list of directory servers you have connected to and then disconnected from. Oracle Directory Services Manager saves information about connections that you've used previously and lists them, by optional Name or by server, so that you can select them again.
 - New Connections—used to initiate a new connection

If you are SSO-authenticated, you might see an additional section, described in "[Connecting to an SSO-Enabled Directory as an SSO-Authenticated User](#)" on page 7-12.

2. To reconnect to a live connection, click it.

To select a disconnected connection, click the entry. You see a short version of the Login Dialog with most fields filled in. To remove a selection from the list, select it and then select Delete.

To initiate a connection to a new directory server, click **Create a New Connection** or type Ctrl+N. The New Connection Dialog appears.

3. Select **OID** or **OVD**.
4. Optionally, enter an alias name to identify this entry on the Disconnected Connections list.
5. Enter the server and non-SSL port for the Oracle Internet Directory or Oracle Virtual Directory instance you want to manage.
6. Deselect **SSL Enabled**.

7. Enter the user (usually `cn=orcladmin`) and password.
8. Select the Start Page you want to go to after logging in.
9. Click **Connect**.

After you have logged in to an Oracle Internet Directory or Oracle Virtual Directory server, you can use the navigation tabs to select other pages.

The Oracle Directory Services Manager home pages for Oracle Internet Directory and Oracle Virtual Directory list version information about Oracle Directory Services Manager itself, as well as the directory and database. It also lists directly statistics.

See Also: ["Troubleshooting Oracle Directory Services Manager"](#) on page R-30.

Logging Into the Directory Server from Oracle Directory Services Manager Using SSL

If you are unfamiliar with SSL authentication modes, see ["SSL Authentication Modes"](#) on page 26-3.

When you log in to the server's SSL port, you follow the procedure in ["Logging in to the Directory Server from Oracle Directory Services Manager"](#) on page 7-10, except that you specify the SSL port in Step 5 and do not deselect **SSL Enabled** in Step 6. After you click **Connect** in Step 9, you might be presented with a certificate, depending on the type of SSL authentication.

SSL No Authentication If the directory server is using SSL No Authentication mode (the default), you are not presented with a certificate. SSL No Authentication provides data confidentiality and integrity only but no authentication using X509 certificates.

SSL Server Only Authentication If the directory server is using SSL Server Authentication Only Mode, when you click connect in Step 9, you are presented with the server's certificate. After manually verifying the authenticity of the server certificate, you can accept the certificate permanently, accept the certificate for the current session only, or reject the certificate. If you accept the certificate permanently, the certificate is stored in its Java Key Store (JKS). From then on, you are not prompted to accept the certificate when you connect to that server. If you accept the certificate only for the current session, you are prompted to accept or reject the certificate every time you connect to the server. If you reject the certificate, ODSM closes the connection to the server.

See Also: ["Introduction to Managing ODSM's Java Key Store"](#) on page O-1.

SSL Client and Server Authentication If the server is using SSL Client and Server Authentication Mode, when you click **Connect** in Step 9, you are presented with a certificate. Follow the instructions in ["SSL Server Only Authentication"](#) on page 7-11.

After ODSM accepts the server's certificate, ODSM sends its own certificate to the server for authentication. The server accepts ODSM's certificate if that certificate is present in its trusted list of certificates.

If the DN of ODSM's certificate is present in the server, you do not need to provide the username and password in the connection dialog.

If the DN of ODSM's certificate is not present in the server, you must provide the user name and password.

ODSM's certificate is a self-signed certificate. You must use the `keytool` command to assign a CA signed certificate to ODSM. See [Appendix O, "Managing Oracle Directory Services Manager's Java Key Store."](#)

Connecting to an SSO-Enabled Directory as an SSO-Authenticated User

If you have already been authenticated by the single sign-on server, ODSM allows you to connect to SSO-enabled directories without logging in, provided you have an entry in that directory. When you access the ODSM Welcome page, if you have an entry in only one SSO-enabled directory, ODSM connects you to it. If you have entries in more than one SSO-enabled directory ODSM allows you to select directory you want to connect to, as follows.

Click the small arrow to the right of the label **Click to connect to a directory**. In this case, the dialog box contains an extra section, listing SSO-enabled directories you are authorized to connect to. Select the directory you want. ODSM connects you without requesting a username or password.

If the port you connected to is an SSL port, you still must perform the appropriate steps in [SSL No Authentication](#), [SSL Server Only Authentication](#), or [SSL Client and Server Authentication](#).

Configuring Oracle Directory Services Manager Session Timeout

The default session timeout for Oracle Directory Services Manager is 35 minutes. You can change it by editing the file `web.xml`, which resides in `DOMAIN_HOME/servers/wls_ods1/tmp/_WL_user/odsm_11.1.1.2.0/randomid/war/WEB-INF`. (This assumes your managed server is named `wls_ods1`. Adjust the pathname if your managed server has a different name.)

The file fragment containing the timeout value looks like this:

```
<session-config>
<session-timeout>35</session-timeout>
</session-config>
```

After you change the value, restart the managed server or restart Oracle Directory Services Manager through the WebLogic console.

If you edit the file `web.xml`, keep in mind that the change you make might not be permanent. Oracle Directory Services Manager is deployed from `ORACLE_HOME/ldap/odsm/odsm.ear` to the WebLogic server. The WebLogic server expands `odsm.ear` into the `DOMAIN_HOME/servers/wls_ods1/tmp/_WL_user/odsm_11.1.1.2.0` directory for performance reasons. This is a temporary cache directory for WebLogic server. If you apply a patch that overwrites `ORACLE_HOME/ldap/odsm/odsm.ear`, the changes you made to `web.xml` in the temporary cache directory are also overwritten.

Configuring Oracle HTTP Server to Support Oracle Directory Services Manager in an Oracle WebLogic Server Cluster

Perform the following steps to configure Oracle HTTP Server to route Oracle Directory Services Manager requests to multiple Oracle WebLogic Servers in a clustered Oracle WebLogic Server environment:

1. Create a backup copy of the Oracle HTTP Server's `httpd.conf` file. The backup copy provides a source to revert to if you encounter problems after performing this procedure.

2. Add the following text to the end of the Oracle HTTP Server's `httpd.conf` file and replace the variable placeholder values with the host names and managed server port numbers specific to your environment. Be sure to use the `<Location /odsm/ >` as the first line in the entry. Using `<Location /odsm/faces >` or `<Location /odsm/faces/odsm.jspx >` can distort the appearance of the Oracle Directory Services Manager interface.

```
<Location /odsm/ >
SetHandler weblogic-handler
WebLogicCluster host-name-1:managed-server-port,host-name_2:managed_server_port
</Location>
```

3. Stop, then start the Oracle HTTP Server to activate the configuration change.

Note: Oracle Directory Services Manager loses its connection and displays a session time-out message if the Oracle WebLogic Server in the cluster that it is connected to fails. Oracle Directory Services Manager requests are routed to the secondary Oracle WebLogic Server in the cluster that you identified in the `httpd.conf` file after you log back in to Oracle Directory Services Manager.

Using Command-Line Utilities to Manage Oracle Internet Directory

To use most Oracle Internet Directory command-line utilities and Database client utilities like `sqlplus`, you must set the following environmental variables:

- `ORACLE_HOME` - The location of non-writable files in your Oracle Identity Management installation.
- `ORACLE_INSTANCE` - The location of writable files in your Oracle Identity Management installation.
- `TNS_ADMIN` - The directory where the database connect string is defined in the `tnsnames.ora` file. By default it is the `$ORACLE_INSTANCE/config` directory. The database connect alias as defined in `tnsnames.ora` is `OIDDDB` by default.
- `NLS_LANG` (`APPROPRIATE_LANGUAGE.AL32UTF8`) - The default language set at installation is `AMERICAN_AMERICA`.
- `PATH` - The following directory locations should be added to your `PATH`:

```
$ORACLE_HOME/bin
```

```
$ORACLE_HOME/ldap/bin
```

```
$ORACLE_INSTANCE/bin
```

Many of the activities that you can perform at the command line can also be performed in Oracle Enterprise Manager Fusion Middleware Control or Oracle Directory Services Manager. A few functions are only available from the command line.

Using Standard LDAP Utilities

Oracle Internet Directory supports the standard LDAP command-line utilities `ldapadd`, `ldapaddmt`, `ldapbind`, `ldapcompare`, `ldapdelete`, `ldapmoddn`, `ldapmodify`, `ldapmodifymt`, and `ldapsearch`. For example:

```
ldapbind -D "cn=orcladmin" -q -h "myserver.example.com" -p 3060
```

```
ldapsearch -b "cn=subschemasubentry" -s base "objectclass=*" -p 3060 \  
-D "cn=orcladmin" -q
```

This book contains many examples of LDAP tool use.

See Also:

- ["Managing Entries by Using LDAP Command-Line Tools"](#) on page 13-11.
- The chapter "Oracle Internet Directory Data Management Tools" in *Oracle Fusion Middleware Reference for Oracle Identity Management* for a detailed description of each tool.

For security reasons, avoid supplying a password on the command line whenever possible. A password typed on the command line is visible on your screen and might appear in log files or in the output from the `ps` command. When you supply a password at a prompt, it is not visible on the screen, in `ps` output, or in log files. Use the `-q` and `-Q` options, respectively, instead of the `-P password` and `-w password` options.

The LDAP tools have been modified to disable the options `-w password` and `-P password` when the environment variable `LDAP_PASSWORD_PROMPTONLY` is set to `TRUE` or `1`. Use this feature whenever possible.

See Also: "Using Passwords with Command-Line Tools" in *Oracle Fusion Middleware Reference for Oracle Identity Management*.

Using Bulk Tools

Oracle Internet Directory provides several tools to help you manage large numbers of entries. See [Chapter 15, "Performing Bulk Operations."](#)

See Also: The chapter "Oracle Internet Directory Data Management Tools" in *Oracle Fusion Middleware Reference for Oracle Identity Management* for a detailed description of each tool.

Using WLST

The Oracle WebLogic Scripting Tool (WLST) is a Jython-based command-line scripting environment that you can use to manage and monitor WebLogic Server domains. To use it to manage and monitor Oracle Internet Directory, you must navigate to the custom MBean tree where Oracle Internet Directory is located. Then you can list, get values, and change values of the managed beans (MBeans) that represent Oracle Internet Directory resources. See ["Managing System Configuration Attributes by Using WLST"](#) on page 9-14 and ["Configuring SSL by Using WLST"](#) on page 26-8.

Note: WLST manages Oracle Internet Directory through its SSL port. The Oracle Internet Directory SSL port must be configured for no authentication or server authentication. If the Oracle Internet Directory SSL port is configured for mutual authentication, you will not be able to change Oracle Internet Directory parameters. by using WLST. See ["SSL Authentication Modes"](#) on page 26-3.

Basic Tasks for Configuring and Managing Oracle Internet Directory

The following provides a summary of the steps you must take to configure and manage a basic Oracle Internet Directory environment:

1. Start and stop the LDAP server. See [Chapter 8](#).
2. Manage system configuration attributes. See [Chapter 9](#).
3. Manage directory entries. See [Chapter 13](#).
4. Manage directory schema. See [Chapter 20](#).
5. Configure auditing. [Chapter 22](#).
6. Manage log files. See [Chapter 23](#).
7. Configure SSL. See [Chapter 26](#).
8. Configure password policies. See [Chapter 28](#).
9. Configure access control. See [Chapter 29](#).
10. Get sizing and tuning recommendations for Oracle Internet Directory deployments. See the "Obtaining Recommendations by Using the Tuning and Sizing Wizard" section of the Oracle Internet Directory chapter in *Oracle Fusion Middleware Performance and Tuning Guide*.
11. Set up replication. See [Chapter 38](#) and [Appendix C](#).
12. Convert an Advanced Replication-based replication agreement to an LDAP-based replication agreement. See "[Converting an Advanced Replication-Based Agreement to an LDAP-Based Agreement](#)" on page 38-15.
13. Modify an existing replication setup. See [Chapter 41](#).

This guide describes other tasks that you might need to perform, depending on your Oracle Fusion Middleware environment.

Managing Oracle Internet Directory Instances

This chapter describes how to create and manage server instances. It contains these topics:

- [Introduction to Managing Oracle Internet Directory Instances](#)
- [Managing Oracle Internet Directory Components by Using Fusion Middleware Control](#)
- [Managing Oracle Internet Directory Components by Using opmnctl](#)
- [Starting an Instance of the Replication Server by Using OIDCTL](#)

See Also: [Appendix B, "Managing Oracle Internet Directory Instances by Using OIDCTL,"](#)

Introduction to Managing Oracle Internet Directory Instances

This introduction contains the following topics:

- [The Instance-Specific Configuration Entry](#)
- [Creating the First Oracle Internet Directory Instance](#)
- [Creating Additional Oracle Internet Directory Instances](#)
- [Registering an Oracle Instance or Component with the WebLogic Server](#)

The Instance-Specific Configuration Entry

In 11g Release 1 (11.1.1), configuration information for an Oracle Internet Directory instance resides in an instance-specific configuration entry, which has a DN of the form

```
cn=componentname,cn=oslddapd,cn=subconfigsentry
```

where *componentname* is the name of a Oracle Fusion Middleware system component of Type=OID, for example, `oid2`. You do not manually create an instance-specific configuration entry. Instead, you create a Oracle Fusion Middleware system component of Type=OID. Creating the Oracle Internet Directory component automatically generates an instance-specific configuration entry.

[Figure 8–1](#) shows the configuration entries for two Oracle Internet Directory components in the DIT. The DNs for the instance-specific configuration entries are:

```
cn=oid1,cn=oslddapd,cn=subconfigsentry  
cn=oid2,cn=oslddapd,cn=subconfigsentry
```

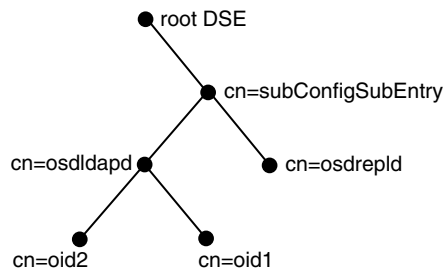
Figure 8–1 DIT Showing Two Instance-Specific Configuration Entries

The attributes in the instance-specific configuration specify information such as hostname, ports, events to be audited, number of child processes, and security configuration. For a complete list, see ["Attributes of the Instance-Specific Configuration Entry"](#) on page 9-2.

Creating the First Oracle Internet Directory Instance

When you install Oracle Internet Directory on a host computer, Oracle Identity Management 11g Installer creates an Oracle Fusion Middleware system component of `Type=OID` in a new or existing Oracle instance (`ASINST`). The Oracle Internet Directory component contains an `OIDMON` process and an Oracle Internet Directory instance (`inst=1`). The Oracle Internet Directory instance consists of a dispatcher process and one or more `OIDLDAPD` processes. The component name for the first Oracle Internet Directory component is usually `oid1` and the Oracle instance name is chosen during the installation, usually `asinst_1`.

Oracle Identity Management 11g Installer creates the following instance-specific configuration entry for this component during installation:

```
cn=oid1,cn=osldapd,cn=subconfigsubentry
```

In addition, Oracle Identity Management 11g Installer creates some file system directories under the Oracle instance directory. Some of the pathnames it creates are specific to the component name. For example, the pathnames under your Oracle instance on UNIX or Linux include:

```
ORACLE_INSTANCE/config/OID/oid1
ORACLE_INSTANCE/diagnostics/logs/OID/oid1
```

If you selected **Create New Domain** or **Extend Existing Domain** during installation, the Oracle Internet Directory component is registered with a WebLogic domain. If you selected **Configure Without a Domain** during installation, the Oracle Internet Directory component is not registered with a domain. You can register it later from the command line. Registering with a domain in this case is optional.

Note: Oracle Internet Directory is frequently configured in a cluster where instances on different hosts are all connected to the same Oracle Database. Oracle Identity Management 11g Installer detects that other `OID` components are using the same Oracle Database and increments the component name for the new component by 1. That is, successive installations in the cluster will have the component names `oid2`, `oid3`, and so forth.

Creating Additional Oracle Internet Directory Instances

The recommended way to add another Oracle Internet Directory instance is to add an additional system component of `Type=OID` in the Oracle instance.

To do this, you use `opmnctl createcomponent`, specifying the component type `Type=OID`, the component name for the new component, and the instance name of the Oracle instance. This new Oracle Internet Directory component consists of an `OIDMON` process, an `OIDLDAPD` dispatcher process, and one or more `OIDLDAPD` server processes. For example, see `ias_component=oid2` at the bottom of [Figure 8-2](#).

Figure 8-2 Oracle Internet Directory Process Control

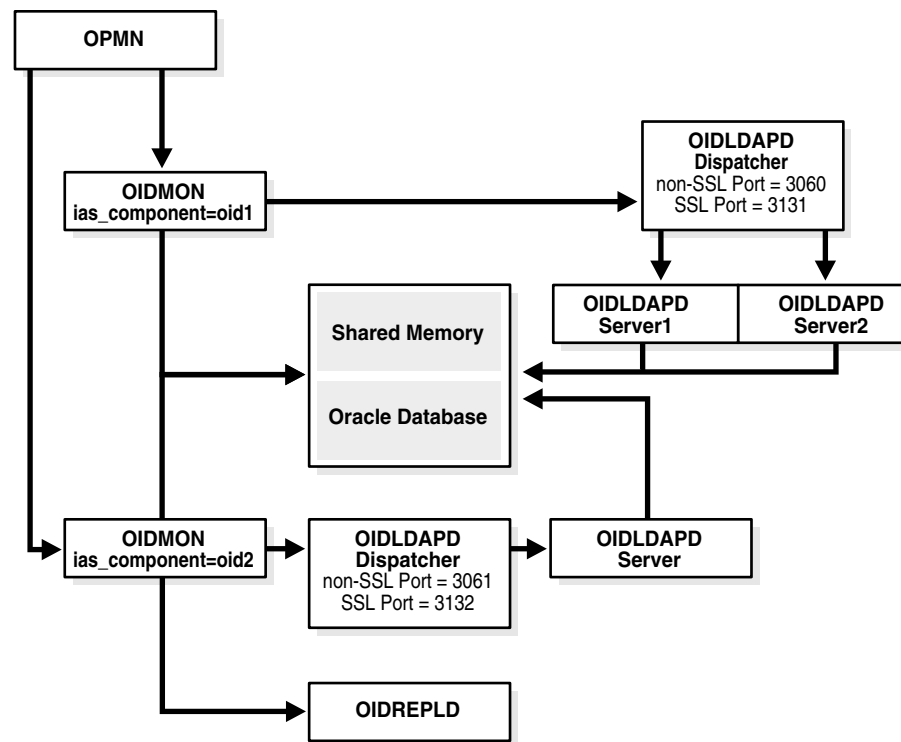

You use an OPMN command, `opmnctl createcomponent`, to create a new instance-specific configuration entry in the DIT. If the new component name is `oid2`, the new entry looks like this:

```
cn=oid2,cn=osldapd,cn=subconfigsubentry
```

You can change the values of attributes in this entry to customize the instance.

The `opmnctl` command also creates additional pathnames in the filesystem under the `ORACLE_INSTANCE` directory for the Oracle instance `asinst_1`. If the new component name is `oid2`, the pathnames include:

```
ORACLE_INSTANCE/config/OID/oid2
ORACLE_INSTANCE/diagnostics/logs/OID/oid2
```

You can use `opmnctl` process control commands to manage the components `oid1` and `oid2` individually. You can register the new Oracle Internet Directory instance with the WebLogic domain, either at creation time or later.

Note: You can use `oidctl` to create an instance if you are running Oracle Internet Directory as a standalone server, not part of a WebLogic domain. When you create an instance with `oidctl`, you must use `oidctl` to stop and start the instance. An Oracle Internet Directory instance created with `oidctl` cannot be registered with a WebLogic server, so you cannot use Oracle Enterprise Manager Fusion Middleware Control to manage the instance. See [Appendix B, "Managing Oracle Internet Directory Instances by Using OIDCTL."](#)

See Also:

- *Oracle Fusion Middleware Oracle Process Manager and Notification Server Administrator's Guide* for more information about OPMN and the `opmnctl` command.
- [Chapter 4, "Understanding Process Control of Oracle Internet Directory Components"](#) for information about Oracle Internet Directory processes.

Registering an Oracle Instance or Component with the WebLogic Server

If you want to manage an Oracle Internet Directory component with Oracle Enterprise Manager Fusion Middleware Control, you must register the component and the Oracle instance that contains it with a WebLogic domain. You can register an Oracle instance with a WebLogic domain during installation or Oracle instance creation, but you are not required to do so. If an Oracle instance was not previously registered with a WebLogic domain, you can register it by using `opmnctl registerinstance`.

If the Oracle instance is already registered, and you are adding a new Oracle Internet Directory system component to the Oracle instance, `opmnctl` automatically registers the component as part of that Oracle instance.

If you change the configuration of a registered component, you can update the information by running `opmnctl updatecomponentregistration`. See [Managing Oracle Internet Directory Components by Using opmnctl](#).

See Also: ["WebLogic Server Domain"](#) on page 2-1.

Managing Oracle Internet Directory Components by Using Fusion Middleware Control

You can view, stop, and start Oracle Internet Directory components by using Oracle Enterprise Manager Fusion Middleware Control. This section contains the following topics:

- [Viewing Active Server Information by Using Fusion Middleware Control](#)
- [Starting the Oracle Internet Directory Server by Using Fusion Middleware Control](#)
- [Stopping the Oracle Internet Directory Server by Using Fusion Middleware Control](#)
- [Restarting the Oracle Internet Directory Server by Using Fusion Middleware Control](#)

Viewing Active Server Information by Using Fusion Middleware Control

To view information about any Oracle Internet Directory component—including type, debug level, host name, and configuration parameters—use Oracle Enterprise Manager Fusion Middleware Control. To do this:

1. Connect to Oracle Enterprise Manager Fusion Middleware Control as described in ["Using Fusion Middleware Control to Manage Oracle Internet Directory"](#) on page 7-4.
2. The Domain Home Page displays the status of components, including Oracle Internet Directory.
3. Select the Oracle Internet Directory component you want to view.
4. View the status information on the Oracle Internet Directory Home page.

Starting the Oracle Internet Directory Server by Using Fusion Middleware Control

Start the Oracle Internet Directory server as follows:

1. Go to the Oracle Internet Directory home page in Oracle Enterprise Manager Fusion Middleware Control.
2. From the Oracle Internet Directory menu, select **Availability**, then **Start Up**.
3. When the confirmation dialog appears, click **OK**.

If Fusion Middleware Control cannot start the server, an error dialog appears.

Stopping the Oracle Internet Directory Server by Using Fusion Middleware Control

Stop the Oracle Internet Directory server as follows:

1. Go to the Oracle Internet Directory home page in Oracle Enterprise Manager Fusion Middleware Control.
2. From the Oracle Internet Directory menu, select **Availability**, then **Shut Down**.
3. When the confirmation dialog appears, click **OK**.

If Fusion Middleware Control cannot stop the server, an error dialog appears.

Restarting the Oracle Internet Directory Server by Using Fusion Middleware Control

Restart the Oracle Internet Directory server as follows:

1. Go to the Oracle Internet Directory home page in Oracle Enterprise Manager Fusion Middleware Control.
2. From the Oracle Internet Directory menu, select **Availability**, then **Restart**.
3. When the confirmation dialog appears, click **OK**.

If Fusion Middleware Control cannot restart the server, an error dialog appears.

Managing Oracle Internet Directory Components by Using opmnctl

You can perform the following Oracle Internet Directory-related tasks from the command line by using `opmnctl`:

- [Creating an Oracle Internet Directory Component by Using opmnctl](#)
- [Registering an Oracle Instance by Using opmnctl](#)

- [Unregistering an Oracle Instance by Using opmnctl](#)
- [Updating the Component Registration of an Oracle Instance by Using opmnctl](#)
- [Deleting an Oracle Internet Directory Component by Using opmnctl](#)
- [Viewing Active Server Instance Information by Using opmnctl](#)
- [Starting the Oracle Internet Directory Server by Using opmnctl](#)
- [Stopping the Oracle Internet Directory Server by Using opmnctl](#)
- [Restarting the Oracle Internet Directory Server by Using opmnctl](#)
- [Changing the Oracle Database Information in opmn.xml](#)

Note: Arguments to `opmnctl` are case sensitive. Be sure to type them exactly as shown. For example, `createcomponent` must be in all lower case and `-adminUsername` must have only the letter U in upper case.

For more information about options to an `opmnctl` command, type:

```
ORACLE_INSTANCE/bin/opmnctl usage command
```

For example:

```
$ORACLE_INSTANCE/bin/opmnctl usage createcomponent
```

See Also:

- "Oracle Internet Directory Administration Tools" in *Oracle Fusion Middleware Reference for Oracle Identity Management* for more information on the syntax of the commands used in the examples
- *Oracle Fusion Middleware Oracle Process Manager and Notification Server Administrator's Guide* for more information about `opmnctl` commands, such as `opmnctl createinstance`.

Creating an Oracle Internet Directory Component by Using opmnctl

You create an Oracle Internet Directory system component in an Oracle instance by using `opmnctl createcomponent`. This command automatically registers the component with a WebLogic domain at the time you create the component, as long as the instance is in a registered state. The syntax is:

```
ORACLE_INSTANCE/bin/opmnctl createcomponent
-componentType OID
-componentName componentName
-adminHost webLogicHostName
-adminPort webLogicPort
[-adminUsername weblogicAdminUsername]
[-adminPasswordFile text_file_containing_admin_password]
-Db_info "DBHostName:Port:DBSvcName"
[-Ods_Password_File 'File_with_DB_ODS_USER_PASSWORD']
[-Sm_Password_File 'File_with_DB_ODSSM_USER_PASSWD']
[-Admin_Password_File 'File_with_OID_Admin_Passwd']
-Namespace "dc=domain_component1,dc=domain_component2..."
[-Port nonSSLPort]
[-Sport SSLPort]
```

The `DBHostName:Port:DBSvcName` argument to the `-DB_info` parameter must be the same as that provided during installation. If it is not, the command will fail. You can find this value in the file `ORACLE_INSTANCE/config/tnsnames_copy.ora`.

If the Oracle Database is based on Real Application Clusters, the argument to the `-DB_info` parameter is of the form:

```
DBHostName1:Port1^DBHostName2:Port2@DBSvcName
```

The `opmnctl` command prompts for the WebLogic administrator's user name if you do not supply it. It also prompts for the passwords if you do not supply password file names on the command line. The `opmnctl` command also uses available ports if you do not specify `-Port` or `-Sport`, as described in "Oracle Internet Directory Ports" on page 3-4.

Registering an Oracle Instance by Using opmnctl

During an Oracle Internet Directory installation, Oracle Identity Management 11g Installer requests domain information. If you choose **Configure Without a Domain**, your Oracle Internet Directory instance is not registered with a WebLogic domain. After the installation is complete, you can choose to register an Oracle instance and all the components in that Oracle instance by using `opmnctl registerinstance`. The syntax is:

```
ORACLE_INSTANCE/bin/opmnctl registerinstance
-adminHost hostname
-adminPort weblogic_port
-adminUsername weblogic_admin_username
```

You are prompted for the WebLogic administrator's user name and password.

For example:

```
ORACLE_INSTANCE/bin/opmnctl registerinstance \
-adminHost myhost \
-adminPort 7001 \
-adminUsername weblogic \
```

The default administrative port on the WebLogic Administration Server is 7001.

Unregistering an Oracle Instance by Using opmnctl

If you registered an Oracle instance with a WebLogic domain during installation, you can unregister it after the install is complete. You might want to do this if you decide to use Oracle Internet Directory in standalone mode. (In standalone mode, you cannot use Fusion Middleware Control or `wlst` to manage Oracle Internet Directory.)

To unregister an Oracle instance and all the components in that Oracle instance, you use `opmnctl unregisterinstance`. The syntax is:

```
ORACLE_INSTANCE/bin/opmnctl unregisterinstance
-adminHost hostname
-adminPort weblogic_port
-adminUsername weblogic_admin
```

you are prompted for the WebLogic administrator's user name and password if you do not supply them.

For example:

```
ORACLE_INSTANCE/bin/opmnctl unregisterinstance \
-adminHost myhost \
```

```
-adminPort 7001 \  
-adminUsername weblogic \  

```

The default administrative port on the WebLogic Administration Server is 7001.

Updating the Component Registration of an Oracle Instance by Using opmnctl

You must update the registration of an Oracle Internet Directory component in a registered Oracle instance whenever you change any of the configuration attributes in [Table 8–1](#) by using LDAP tools, `oidpasswd`, or ODSM. If you do not update the component registration, you will be unable to use Fusion Middleware Control or `wlst` to manage that component.

If you update these attributes by using Fusion Middleware Control or `wlst`, you do not have to update the component registration.

Table 8–1 Attribute Changes Requiring Update of Component Registration

Attribute	See Also
<code>orclhostname</code>	"Attributes of the Instance-Specific Configuration Entry" on page 9-2
<code>orclnonsslport</code>	"Attributes of the Instance-Specific Configuration Entry" on page 9-2
<code>orclsslport</code>	"Attributes of the Instance-Specific Configuration Entry" on page 9-2
<code>userpassword</code>	"Changing the Password for the EMD Administrator Account" on page 12-7

To update the registration of an Oracle Internet Directory component, you use `opmnctl updatecomponentregistration`. The syntax is:

```
ORACLE_INSTANCE/bin/opmnctl updatecomponentregistration  
-adminHost hostname  
-adminPort weblogic_port  
-adminUsername weblogic_admin  
-componentType OID  
-componentName compName  
-Port non-sslport  
-Sport sslport
```

For example:

```
ORACLE_INSTANCE/bin/opmnctl updatecomponentregistration \  
-adminHost myhost \  
-adminPort 7001 \  
-adminUsername weblogic \  
-componentType OID \  
-componentName oid2 \  
-Port 3061 \  
-Sport 3131
```

You are prompted for the WebLogic administrator's user name and password if you do not supply them.

The default administrative port on the WebLogic Administration Server is 7001.

You must supply both a non-SSL port and an SSL port.

Deleting an Oracle Internet Directory Component by Using opmnctl

You remove an Oracle Internet Directory component by using `opmnctl deletecomponent`. This also unregisters the component with the WebLogic server. The syntax is:

```
$ORACLE_INSTANCE/bin/opmnctl deletecomponent
  -adminHost webLogicHostName
  -adminPort webLogicPort
  -adminUsername weblogicAdminUsername
  -adminPasswordFile text_file_containing_admin_password
  -componentType OID
  -componentName componentName
```

you are prompted for the WebLogic administrator's user name and password if you do not supply them.

Viewing Active Server Instance Information by Using opmnctl

To view the status of components and processes by using `opmnctl`, type:

```
opmnctl status -l
```

For example:

```
$ ./opmnctl status -l
```

```
Processes in Instance: asinst_2
```

ias-component				process-type	pid	status
uid	memused	uptime	ports			
oid2				oidldapd	24760	Alive
988238800	102744	0:01:12		N/A		
oid2				oidldapd	24756	Alive
988238799	55052	0:01:12		N/A		
oid2				oidmon	24745	Alive
988238796	48168	0:01:14		LDAPS:6789,LDAP:6788		
oid1				oidldapd	21590	Alive
988238048	103716	19:51:48		N/A		
oid1				oidldapd	21586	Alive
988238047	54420	19:51:49		N/A		
oid1				oidmon	21577	Alive
988238046	48168	19:51:49		LDAPS:3133,LDAP:3060		

Starting the Oracle Internet Directory Server by Using opmnctl

The component name of the first Oracle Internet Directory component is `oid1`.

To start the first Oracle Internet Directory instance, type:

```
opmnctl startproc ias-component=oid1
```

To start all Oracle Internet Directory instances, type

```
opmnctl startproc process-type=OID
```

To start all components, type

```
opmnctl startall
```

Stopping the Oracle Internet Directory Server by Using opmnctl

To stop the first Oracle Internet Directory server component, type:

```
opmnctl stopproc ias-component=oid1
```

To stop all Oracle Internet Directory instances, type

```
opmnctl stopproc process-type=OID
```

To stop all components, type

```
opmnctl stopall
```

Restarting the Oracle Internet Directory Server by Using opmnctl

To restart the first Oracle Internet Directory instance, type:

```
opmnctl restartproc ias-component=oid1
```

To restart all Oracle Internet Directory instances, type

```
opmnctl restartproc process-type=OID
```

Changing the Oracle Database Information in opmn.xml

By default, *ORACLE_INSTANCE/config/OPMN/opmn/opmn.xml* contains an XML snippet that `opmnctl` uses when it attempts to start the default Oracle Internet Directory LDAP server instance. Occasionally, you might need to edit the `opmn.xml` file. For example, if you change the Oracle Database instance in *ORACLE_INSTANCE/config/tnsnames.ora*, you must add the Oracle Database `DB_CONNECT_STR` to *ORACLE_INSTANCE/config/OPMN/opmn/opmn.xml*. You can use a text editor to edit `opmn.xml`.

See Also: ["Oracle Internet Directory Snippet in opmn.xml"](#) on page 4-3.

Starting an Instance of the Replication Server by Using OIDCTL

To configure an instance of Oracle Internet Directory Replication Server, use the `oidctl start` command with `server=oidrepld`. Best practice is to create a separate instance of Oracle Internet Directory to use for replication.

First create a new instance of Oracle Internet Directory as described in ["Creating Additional Oracle Internet Directory Instances"](#) on page 8-3. Then, ensure that the environment variable `ORACLE_INSTANCE` is set and type:

```
oidctl connect=connStr server=oidrepld inst=1 componentname=Component_Name \  
name=Instance_Name start
```

The `componentname` value must be the `component` name of the running `oidldapd` server. The `name` value must be the instance name of the running `oidldapd` server.

Do not start more than one instance of `oidrepld` on a host. Do not start `oidrepld` on more than one Oracle Internet Directory instance sharing the same Oracle Database.

Note: The environment variables `ORACLE_INSTANCE`, `ORACLE_HOME`, and `COMPONENT_NAME` must be set before you run the `oidctl` command to start or stop the replication server.

See Also:

- [Chapter 6, "Understanding Oracle Internet Directory Replication"](#)
- [Chapter 38, "Setting Up Replication"](#)

Managing System Configuration Attributes

This chapter describes attributes that control the LDAP server. See [Chapter 40, "Managing Replication Configuration Attributes"](#) for information about attributes that control the replication server.

This chapter contains the following topics:

- [Introduction to Managing System Configuration Attributes](#)
- [Managing System Configuration Attributes by Using Fusion Middleware Control](#)
- [Managing System Configuration Attributes by Using WLST](#)
- [Managing System Configuration Attributes by Using LDAP Tools](#)
- [Managing System Configuration Attributes by Using ODSM Data Browser](#)

See Also: ["Kinds of Attribute Information"](#) on page 3-9

Introduction to Managing System Configuration Attributes

This introduction contains the following topics:

- [What are Configuration Attributes?](#)
- ["What are Operational Attributes?"](#) on page 9-2
- [Attributes of the Instance-Specific Configuration Entry](#)
- [Attributes of the DSA Configuration Entry](#)
- [Attributes of the DSE](#)

What are Configuration Attributes?

Most Oracle Internet Directory configuration information is stored in the directory itself. The information is stored as attributes of specific configuration entries. You must have superuser privileges to set system configuration attributes.

Some configuration attributes are specific to an individual instance of the Oracle Internet Directory server. Instance-specific attributes are located in the instance-specific configuration entry, a specific subentry of the Oracle Internet Directory instance entry. [Figure 8-1, "DIT Showing Two Instance-Specific Configuration Entries"](#) show s the location of these entries in the DIT.

Some configuration attributes are shared by all Oracle Internet Directory server instances in a WebLogic Server domain that are connected to the same database. Shared attributes reside in the DSA Configuration entry. Replication-specific attributes

reside in the Replica Subentry, Replication Configuration, and Replication Agreement Entry.

Some attributes reside in the DSE Root. Most of those are non-configurable.

See Also: [Chapter 4, "Understanding Process Control of Oracle Internet Directory Components"](#).

You can manage all the configuration attributes from the command-line. In addition, many of the configuration attributes have specific, task-oriented management interfaces in Oracle Enterprise Manager Fusion Middleware Control or Oracle Directory Services Manager. You can also use the Data Browser feature of Oracle Directory Services Manager to manage the entries directly.

See Also:

- ["Managing System Configuration Attributes by Using Fusion Middleware Control"](#) on page 9-11
- ["Managing System Configuration Attributes by Using LDAP Tools"](#) on page 9-16
- ["Managing System Configuration Attributes by Using ODSM Data Browser"](#) on page 9-18

What are Operational Attributes?

Do not confuse configuration attributes with operational attributes. Operational attributes have special meaning to the directory server and they are used for storing information needed for processing by the server itself or for holding other data maintained by the server that is not explicitly provided by clients. These are attributes that are maintained by the server and either reflect information the server manages about an entry or affect server operation.

Operational attributes are not returned by a search operation unless you specifically request them by name or with the "+" option in the search request. See ["Listing Operational Attributes by Using ldapsearch"](#) on page 13-11 for more information.

Examples of operational attributes include the time stamp for an entry and the state values needed for enforcing password policies, described in ["Password Policy-Related Operational Attributes"](#) on page 28-7. You cannot modify operational attributes.

Attributes of the Instance-Specific Configuration Entry

During installation, Oracle Identity Management 11g Installer creates an instance-specific configuration entry for the first Oracle Internet Directory instance. It copies default values from a read-only entry under `cn=configset0`. (You can specify different values for the SSL port and non-SSL during the install.)

The DN of an instance-specific configuration entry has the form:

```
cn=componentname,cn=osldapd,cn=subconfigsubentry
```

For example, if the component name for a server instance is `oid1`, then the DIT of the instance-specific configuration entry would be:

```
cn=oid1,cn=osldapd,cn=subconfigsubentry
```

[Table 9-1](#) lists the attributes of the instance-specific configuration entry. The **Update Mechanism** column contains the following abbreviations:

- EM – Oracle Enterprise Manager Fusion Middleware Control. See ["Managing System Configuration Attributes by Using Fusion Middleware Control"](#) on page 9-11.
- WLST–WebLogic Scripting tool. See ["Managing System Configuration Attributes by Using WLST"](#) on page 9-14
- LDAP–LDAP command-line tools, such as `ldapmodify` and `ldapadd`. See ["Managing System Configuration Attributes by Using LDAP Tools"](#) on page 9-16

Table 9–1 Attributes of the Instance-Specific Configuration Entry

Attribute	Description	Update Mechanism	Default	Possible Values
<code>orclserverprocs</code>	Number of Server Processes. Restart the server after changing. See Chapter 4 .	EM, LDAP, WLST	1	Integer, up to 1024.
<code>orclreqattrcase</code>	Preserve the case of required attribute names specified in an <code>ldapsearch</code> request. See Chapter 7 .	EM, LDAP	0	0: Do not preserve attribute case 1: Preserve attribute case
<code>orclhostname</code>	Hostname or IP address. See Chapter 10 . If you change the hostname by using LDAP tools, run <code>opmnctl updatecomponentregistration</code> and restart the server. See Chapter 8, "Managing Oracle Internet Directory Instances"	LDAP	Set during install	Host or IP address
<code>orclnonsslport</code>	Non-SSL port See "Configuring Server Properties" on page 9-11. If you change the port number by using LDAP tools, restart the server and run <code>opmnctl updatecomponentregistration</code> . See Chapter 8, "Managing Oracle Internet Directory Instances" .	EM, LDAP, WLST	3060	Port number
<code>orclsslport</code>	SSL port See "Configuring Server Properties" on page 9-11. If you change the port number by using LDAP tools, restart the server and run <code>opmnctl updatecomponentregistration</code> . See Chapter 8, "Managing Oracle Internet Directory Instances" .	EM, LDAP, WLST	3131	Port number

Table 9–1 (Cont.) Attributes of the Instance-Specific Configuration Entry

Attribute	Description	Update Mechanism	Default	Possible Values
orclservermode	Server Mode See Chapter 15 .	EM, LDAP, WLST	rw	R: read-only rw: read/write rm: read-modify
orclaudcustevents	A comma-separated list of events and category names to be audited. Custom events are only applicable when <code>orclAudFilterPreset</code> is <code>Custom</code> . See Chapter 22 .	EM, LDAP, WLST	Empty	Examples include: Authentication.SUCSESSE ONLY, Authorization(Permission -eq 'CSFPerfmission')
orclaudfilterpreset	Replaces the audit levels used in 10g (10.1.4.0.1) and earlier releases. See Chapter 22 .	EM, LDAP, WLST	None	None, Low, Medium, All, and Custom.
orclaudsplusers	A comma separated list of users for whom auditing is always enabled, even if <code>orclAudFilterPreset</code> is <code>None</code> . See Chapter 22 .	EM, LDAP, WLST	Empty	Valid users. For example: cn=orcladmin.
orcldebugflag	Debug Flag See Chapter 23 .	EM, LDAP, WLST	0	0 ~ 117440511 See Table 23–3 .
orcldebugforceflush	Force flush debug messages See Chapter 23 .	LDAP	0	0: Disable 1: Enable
orcldebugop	Operations Enabled for Debug See Chapter 23 .	EM, LDAP, WLST	511	See Table 23–4 , "Debug Operations". on page 23-7
orclmaxlogfiles	Maximum Number of Log Files to Keep in Rotation See Chapter 23 .	EM, LDAP, WLST	100	Integer
orclmaxlogfilesize	Maximum Log File Size (MB) See Chapter 23 .	EM, LDAP, WLST	1 MB	Size, in MB
orcleventlevel	Statistics collection event level See Chapter 24 .	EM, LDAP, WLST	0	See Table 24–5 , "Event Levels" on page 24-9.
orcloptracklevel	Security event tracking level See Chapter 24 .	EM, LDAP, WLST	0	Table 24–3 , "Values of <code>orcloptracklevel</code> " on page 24-8
orclstatsflag	Flag to turn on or off OID statistics data See Chapter 24 .	EM, LDAP, WLST	1	0: disable 1: enable
orclstatslevel	Enable user statistics collection See Chapter 24 .	EM, LDAP, WLST	0	0: disable 1: enable

Table 9–1 (Cont.) Attributes of the Instance-Specific Configuration Entry

Attribute	Description	Update Mechanism	Default	Possible Values
orclstatsperiodicity	Frequency of flushing statistics to data bases See Chapter 24 .	EM, LDAP, WLST	30	60
orclsslauthentication	SSL Authentication Restart the server after changing See Chapter 26 .	EM, LDAP, WLST	1	1: No SSL authentication 32: One-way authentication 64: Two-way authentication
orclsslciphersuite	SSL Cipher Suite Restart the server after changing See Chapter 26 .	EM, LDAP, WLST	Empty	See Table 26–1 , "SSL Cipher Suites Supported in Oracle Internet Directory" on page 26-2, left column.
orclsslenable	SSL Enable Restart the server after changing. Do not set <code>orclsslenable</code> to 1 if you use WLST or EM to configure the server. See Chapter 26 .	EM, LDAP, WLST	2	0: Non-SSL only 1: SSL only, 2: Non-SSL & SSL mode
orclsslinteropmode	SSL Interoperability Mode Restart the server after changing See Chapter 26	LDAP	1	0: disabled 1: enabled
orclsslversion	SSL Version Restart the server after changing See Chapter 26 .	EM, LDAP, WLST	3	3
orclsslwalleturl	SSL Wallet URL Restart the server after changing See Chapter 26 .	EM, LDAP, WLST	File	SSL wallet file location.
orclsanonymousbindsflag	Allow Anonymous binds See Chapter 32 ,	EM, LDAP, WLST	2	See Table 32–4 , "Orclsanonymousbindsflag Value and Directory Server Behavior" on page 32-8.
orclsaslauthenticationmode	SASL Authentication Restart the server after changing Mode See Chapter 32 .	EM, LDAP, WLST	1	auth, auth-int, auth-conf. Specify all three or a subset of these 3 as a comma separated string.
orclsaslcipherchoice	SASL Cipher Choice Restart the server after changing See Chapter 32 .	EM, LDAP, WLST	Rc4-56,rc4-40,rc4,des,3des	Any combination of Rc4-56, des, 3des, rc4, rc4-40

Table 9–1 (Cont.) Attributes of the Instance-Specific Configuration Entry

Attribute	Description	Update Mechanism	Default	Possible Values
orclsaslmechanism	SASL Mechanism Restart the server after changing See Chapter 32 .	EM, LDAP, WLST	DIGEST-MD5, EXTERNAL	DIGEST-MD5, EXTERNAL
orcldispthreads	Maximum number of dispatcher threads per server process. See the Oracle Internet Directory chapter in <i>Oracle Fusion Middleware Performance and Tuning Guide</i> Restart server after changing.	EM, LDAP, WLST	1	Integer (Max 16)
orclcacheenabled	Enable Entry Cache See the Oracle Internet Directory chapter in <i>Oracle Fusion Middleware Performance and Tuning Guide</i> .	EM, LDAP, WLST	1	1: Enable, 0: Disable
orclcachemaxentries	Maximum Entries in Entry Cache See the Oracle Internet Directory chapter in <i>Oracle Fusion Middleware Performance and Tuning Guide</i> .	EM, LDAP, WLST	100000	Integer
orclcachemaxentsize	Maximum Entry Size in Cache See the Oracle Internet Directory chapter in <i>Oracle Fusion Middleware Performance and Tuning Guide</i> .	EM, LDAP, WLST	1000000	Integer
orclcachemaxsize	Entry Cache Size in bytes See the Oracle Internet Directory chapter in <i>Oracle Fusion Middleware Performance and Tuning Guide</i> .	EM, LDAP, WLST	200000000 Bytes	Size_t (can be specified using K, M, or G as Kilo, Mega and Giga bytes respectively). For example, 200M is a valid value.
orclenablegroupcache	Enable/Disable Group cache See the Oracle Internet Directory chapter in <i>Oracle Fusion Middleware Performance and Tuning Guide</i> .	LDAP	1	1 Enable, 0 Disable

Table 9–1 (Cont.) Attributes of the Instance-Specific Configuration Entry

Attribute	Description	Update Mechanism	Default	Possible Values
orclldapconntimeout	LDAP Connection Timeout, in minutes See the Oracle Internet Directory chapter in <i>Oracle Fusion Middleware Performance and Tuning Guide</i> .	EM, LDAP, WLST	0	Integer Note: Users configured for statistics tracking do not time out as per this setting.
orclmaxcc	Maximum Number of DB Connections Restart the server after changing. See the Oracle Internet Directory chapter in <i>Oracle Fusion Middleware Performance and Tuning Guide</i> .	EM, LDAP, WLST	2	Integer, maximum128
orclmaxconnincache	Maximum number of cached user group connections See the Oracle Internet Directory chapter in <i>Oracle Fusion Middleware Performance and Tuning Guide</i> .	EM, LDAP, WLST	100000	Integer
orclmaxldapconns	Maximum number of concurrent connections per server process See the Oracle Internet Directory chapter in <i>Oracle Fusion Middleware Performance and Tuning Guide</i> .	EM, LDAP, WLST	1024	Int (Max system max file descriptors per process)
orclmaxserverresptime	Maximum Time in seconds for Server process to respond back to Dispatcher process See the Oracle Internet Directory chapter in <i>Oracle Fusion Middleware Performance and Tuning Guide</i> .	EM, LDAP, WLST	300 seconds	Number of Seconds 0: Dispatcher does not detect the server hang.
orclnwrwtimeout	Maximum time in seconds for OID Server to wait for LDAP client respond to a Read/Write operation. See the Oracle Internet Directory chapter in <i>Oracle Fusion Middleware Performance and Tuning Guide</i> .	EM, LDAP, WLST	30 seconds	Integer

Table 9–1 (Cont.) Attributes of the Instance-Specific Configuration Entry

Attribute	Description	Update Mechanism	Default	Possible Values
orcloptrackmaxtotalsize	<p>Maximum number of bytes of RAM that security events tracking can use for each type of operation.</p> <p>See the Oracle Internet Directory chapter in <i>Oracle Fusion Middleware Performance and Tuning Guide</i>.</p>	LDAP	100000000 Bytes	Available RAM, in bytes
orcloptracknumelemcontainers; 1stlevel	<p>Number of in-memory cache containers for storing information about users performing operations.</p> <p>See the Oracle Internet Directory chapter in <i>Oracle Fusion Middleware Performance and Tuning Guide</i>.</p>	LDAP	256	Integer
orcloptracknumelemcontainers; 2ndlevel	<p>Number of in-memory cache containers for storing information about users whose user password is compared and tracked when detailed compare operation statistics is programmed.</p> <p>See the Oracle Internet Directory chapter in <i>Oracle Fusion Middleware Performance and Tuning Guide</i>.</p>	LDAP	256	Integer
orclpluginworkers	<p>Maximum number of plug-in worker threads per server process</p> <p>Restart the server after changing.</p> <p>See the Oracle Internet Directory chapter in <i>Oracle Fusion Middleware Performance and Tuning Guide</i>.</p>	EM, LDAP, WLST	2	Int (Max 64)

Table 9–1 (Cont.) Attributes of the Instance-Specific Configuration Entry

Attribute	Description	Update Mechanism	Default	Possible Values
orclsizeLimit	Number of entries that can be returned in an <code>ldapsearch</code> result See the Oracle Internet Directory chapter in Oracle Fusion Middleware Performance and Tuning Guide.	LDAP	10000	Integer
orcltimeLimit	Maximum time that server can spend for a given <code>ldapsearch</code> operation	EM, LDAP, WLST	3600	Integer (seconds)
orclsdumpflag	Generate stack dump. See Appendix R .	LDAP	0	0: Generate stack trace file. 1: Do not generate stack trace file, but generate a core file.

Attributes of the DSA Configuration Entry

The DSA configuration entry has the DN:

```
cn=dsaconfig,cn=configsets,cn=oracle internet directory
```

[Table 9–2](#) shows shared attributes in the DSA configuration entry. The **Update Mechanism** column contains the following abbreviations:

- EM – Oracle Enterprise Manager Fusion Middleware Control. See "[Managing System Configuration Attributes by Using Fusion Middleware Control](#)" on page 9-11.
- LDAP – LDAP command-line tools, such as `ldapmodify` and `ldapadd`. See "[Managing System Configuration Attributes by Using LDAP Tools](#)" on page 9-16

Note: DSA is an X.500 term for the directory server.

Table 9–2 Attributes in the DSA Configuration Entry

Attribute	Description	Update Mechanism	Default	Possible Values
orclmaxfiltsize	Maximum Filter Size See " Configuring Shared Properties " on page 9-13.	EM, LDAP	24576	Integer
orclrefreshdgrmems	Refresh Dynamic Group Memberships. See Chapter 14 .	LDAP	0	Set to 1 to cause a refresh. Server will reset it to 0.
orclrienabled	Referential Integrity. See Chapter 21 .	EM, LDAP	0	0: Disabled 1: Enabled
orclstatsdn	User DNs for statistics collection. See Chapter 24 .	EM, LDAP	Empty	DNs of entries
orcldataprivacymod e	Sensitive attributes encrypted when returned See Chapter 27 .	LDAP	0	0: Disabled 1: Enabled

Table 9–2 (Cont.) Attributes in the DSA Configuration Entry

Attribute	Description	Update Mechanism	Default	Possible Values
orclencryptedattributes	Sensitive attributes stored in encrypted format. See Chapter 27 .	LDAP	See Table 27–1 on page 27-6.	Attributes
orclhashedattributes	Attributes stored in hashed format. See Chapter 27 .	EM, LDAP	Empty	Attributes
orclpkimatchingrule	PKI Matching Rule for mapping user's PKI certificate DN to the user's entry DN. See Chapter 32 .	EM, LDAP	2	0: Exact match. 1: Certificate search. 2: Combination of 0 and 1. 3: Mapping rule only. 4: Try in order: 3, 2
orclgeneratechange log	Whether to generate change logs for user operations. See Chapter 41 and the Oracle Internet Directory chapter of <i>Oracle Fusion Middleware Performance and Tuning Guide</i>	LDAP	1	1: enable 0: disable
orclinmemfiltprocess	Search Filters to be processed in memory See the Oracle Internet Directory chapter in <i>Oracle Fusion Middleware Performance and Tuning Guide</i> .	EM, LDAP	See list in <i>Oracle Fusion Middleware Performance and Tuning Guide</i>	Valid search filters
orclmatchdnenabled	Whether to provide detailed MatchDN information when base DN of a search is not present. See the Oracle Internet Directory chapter of <i>Oracle Fusion Middleware Performance and Tuning Guide</i>	EM, LDAP	1	0: Do not match 1: Match
orclskewedattribute	Skewed attributes. Server restart recommended after changing. See the Oracle Internet Directory chapter in <i>Oracle Fusion Middleware Performance and Tuning Guide</i> .	EM, LDAP	objectclass	List of attributes
orclskiprefinsql	Skip referral for search. Server restart recommended after changing. See the Oracle Internet Directory chapter in <i>Oracle Fusion Middleware Performance and Tuning Guide</i> .	EM, LDAP	0	0: Disabled 1: Enabled
orcltlimitmode	Specify search time limit mode to be either accurate or approximate.	LDAP	0	0: Accurate 1: Approximate

Attributes of the DSE

The DSA-specific entry (DSE) is the root of the DIT. This is where Oracle Internet Directory publishes information about itself, such as naming contexts, supported

controls, and matching rules. Most attributes of the DSE should not be modified directly. Some attributes that you might need to modify are listed in [Table 9–3](#).

Table 9–3 Attributes of the DSE

Attribute	Description	Update Mechanism	Default	Possible Values
namingcontexts	Naming contexts. See Chapter 11 .	LDAP	c=us dc=com	Any valid naming context.
ref	Referral specification. See Chapter 19 .	LDAP		
orclaci	Access control at the root DSE level. See Chapter 29 .	LDAP		
orclcryptoscheme	Hashing algorithm for protecting passwords. See Chapter 30 .	LDAP	SHA	MD4, MD5, SHA, SSHA, SHA256, SHA384, SHA512, SSHA256, SSHA384, SSHA512, SMD5, UNIX Crypt
subentry	Contains DN of password policy governing the DSE root. See Chapter 28 .	LDAP	cn=default,cn=pwdPolicies,cn=Common,cn=Products,cn=OracleContext	

Managing System Configuration Attributes by Using Fusion Middleware Control

You can view and set most of the configuration attributes for an Oracle directory server by using Oracle Enterprise Manager Fusion Middleware Control.

This section contains the following topics:

- [Configuring Server Properties](#)
- [Configuring Shared Properties](#)
- [Configuring Other Parameters](#)

Configuring Server Properties

You can configure most of the attributes in the instance-specific configuration entry by using the Oracle Internet Directory **Server Properties** pages of Fusion Middleware Control., as follows:

1. Select **Administration**, then **Server Properties** from the **Oracle Internet Directory** menu.
2. Select **General**, **Performance**, **SASL**, **Statistics**, or **Logging**, depending on which parameters you want to configure.
3. After changing the configuration, choose **Apply**.

The correspondence between server properties and configuration attributes on the General tab of the Server Properties page is shown in [Table 9–4](#).

General

Table 9–4 Configuration Attributes on Server Properties Page, General Tab.

Field or Heading	Configuration Attribute
Server Mode	orclservermode
Maximum number of entries to be returned by a search	orclsizelimit
Maximum time allowed for a search to complete (sec)	orcltimelimit
Preserve Case of Required Attribute Name specified in Search Request	orclreqattrcase
Anonymous Bind	orclanonymousbindsflag
Non-SSL Port	orclnonsslport
SSL Port	orclsslport

Performance

The correspondence between server properties and configuration attributes on the Performance tab of the Server Properties page is shown in [Table 9–5](#)

Table 9–5 Configuration Attributes on Server Properties Page, Performance Tab

Field or Heading	Configuration Attribute
Number of OID LDAP Server Processes	orclserverprocs
Number of DB Connections per Server Process	orclmaxcc
Enable Entry Cache	orclecacheenabled
Maximum Entries in Entry Cache	orclecachemaxentries
Maximum Entry Size in Cache (byte)	orclecachemaxentsize
Maximum Entry Cache Size (MB)	orclecachemaxsize
Number of users in privilege group membership cache	orclmaxconnincache
LDAP Idle Connection Timeout (minutes)	orclldapconntimeout
OID server Network Read/Write Retry Timeout (sec)	orclnrwtimeout
Maximum Time in seconds for Server process to respond back to Dispatcher process	orclMaxServerRespTime
Number of Dispatcher Threads per Server Process	orcldispthreads
Maximum Number of LDAP connections per Server Process	orclmaxldapconns
Number of Plugin Threads per Server Process	orclpluginworkers
Enable Change Log Generation	orclgeneratechangelog

Restart the server after changing orclserverprocs, orclmaxcc, orcldispthreads, or orclpluginworkers.

SASL

The correspondence between server properties and configuration attributes on the SASL tab of the Server Properties page is shown in [Table 32–1, "Configuration Attributes on Server Properties, SASL Tab"](#).

Statistics

The correspondence between server properties and configuration attributes on the Statistics tab of the Server Properties page is shown in [Table 24–2, "Configuration Attributes on Server Properties Page, Statistics Tab"](#).

Logging

The correspondence between server properties and configuration attributes on the Logging tab of the Server Properties page is shown in [Table 23–2, "Configuration Attributes on Server Properties Page, Logging Tab"](#).

Configuring Shared Properties

You can configure some of the shared system configuration attributes in the DSA configuration entry by using the Oracle Internet Directory **Shared Properties** page of Fusion Middleware Control. Select **Administration**, then **Shared Properties**, then select **General**, **Change Superuser Password**, or **Replication** from the **Oracle Internet Directory** menu. After changing the configuration, choose **Apply**. The correspondence is as follows:

General

Table 9–6 Configuration Attributes on Shared Properties Page, General Tab

Field or Heading	Configuration Attribute
User DN	orclstatsdn
Skip referral for search	orclskiprefinsql
Skewed attributes	orclskewedattribute
Search Filters to be processed in memory	orclinmemfiltprocess
Hashed attributes	orclhashedattributes
Match DN	orclMatchDnEnabled
PKI Matching Rule	orclPKIMatchingRule
Referential Integrity	orclrienabled
Maximum Filter Size	orclmaxfiltsize

A server restart is recommended after changing `orclskiprefinsql` or `orclskewedattribute`.

Change Superuser Password

See ["Changing the Superuser Password by Using Fusion Middleware Control"](#) on page 12-5.

Replication

Replication-related attributes are described in [Chapter 40, "Managing Replication Configuration Attributes."](#) See ["Configuring Attributes on the Shared Properties, Replication Tab"](#) on page 40-12

Configuring Other Parameters

You can configure SSL parameters by using the Oracle Internet Directory SSL Configuration Page. See "[Configuring SSL by Using Fusion Middleware Control](#)" on page 26-5. You must restart the server for SSL configuration changes to take effect.

You can configure Audit attributes by using the Oracle Internet Directory Audit Policy Settings page. See "[Managing Auditing by Using Fusion Middleware Control](#)" on page 22-4.

Managing System Configuration Attributes by Using WLST

A managed bean (MBean) is a Java object that represents a JMX manageable resource in a distributed environment, such as an application, a service, a component or a device. The WebLogic server uses custom MBeans as its interface to OPMN-managed components, such as Oracle Internet Directory. You can use the WebLogic Scripting Tool (`wlst`) in the Oracle Common home to manage the attributes of the Oracle Internet Directory instance-specific configuration entry that have Oracle Enterprise Manager Fusion Middleware Control interfaces.

Note: WLST manages Oracle Internet Directory through its SSL port. The Oracle Internet Directory SSL port must be configured for no authentication or server authentication. If the Oracle Internet Directory SSL port is configured for mutual authentication, you will not be able to change Oracle Internet Directory parameters by using WLST. See "[SSL Authentication Modes](#)" on page 26-3.

See Also:

- *Oracle Fusion Middleware Administrator's Guide*
- *Oracle Fusion Middleware Oracle WebLogic Scripting Tool*
- "[Configuring SSL by Using WLST](#)" on page 26-8
- "[Managing Auditing by Using WLST](#)" on page 22-5

You use WLST as follows:

1. Invoke WLST

```
ORACLE_COMMON_HOME/common/bin/wlst.sh
```

2. Connect to the WebLogic server

```
connect('username', 'password', 'localhost:7001')
```

3. To navigate to the custom mbean tree, type:

```
custom()
```

at the `wlst` prompt.

4. To get a one-level list of the MBean in the custom MBean tree, type:

```
ls()
```

In the `ls()` output, you see two domains that contain MBeans that are related to Oracle Internet Directory configuration. The domains are `oracle.as.management.mbeans.register` and `oracle.as.oid`.

5. To get to a domain, use the `cd()` command. For example:

```
cd('oracle.as.management.mbeans.register')
```

or

```
cd('oracle.as.oid')
```

If you type `ls()`, you see a list of MBeans in that domain. There are three MBeans related to Oracle Internet Directory configuration under `oracle.as.management.mbeans.register` and two under `oracle.as.oid`. [Table 9-7](#) lists them.

Table 9-7 Oracle Internet Directory-Related MBeans

MBean Name	MBean Domain	MBean Format in ls() Output
Root Proxy MBean	oracle.as.management.mbeans.register	oracle.as.management.mbeans.register:type=component,name=COMPONENT_NAME,instance=INSTANCE
Non-SSL Port MBean	oracle.as.management.mbeans.register	oracle.as.management.mbeans.register:type=component.nonsslport,name=nonsslport1,instance=INSTANCE,component=COMPONENT_NAME
Audit MBean	oracle.as.management.mbeans.register	oracle.as.management.mbeans.register:type=component.auditconfig,name=auditconfig1,instance=INSTANCE,component=COMPONENT_NAME
SSL Port MBean	oracle.as.oid	oracle.as.oid:type=component.sslconfig,name=sslport1,instance=INSTANCE,component=COMPONENT_NAME
Key Store MBean	oracle.as.oid	oracle.as.oid:type=component.keystore,name=keystore,instance=INSTANCE,component=COMPONENT_NAME

INSTANCE and *COMPONENT_NAME* refer to the Oracle instance where your Oracle Internet Directory component is located and the name of the component, respectively.

Note: The Audit MBean is shown here for completeness, but you use different commands for managing auditing by using `wlst`. See ["Managing Auditing by Using WLST"](#) on page 22-5.

6. To get to a specific MBean, type:

```
cd('MBean_NAME')
```

For example, if you are in the domain `oracle.as.management.mbeans.register`, and you want to manage the Root Proxy MBean for Oracle Internet Directory component `oid1` in Oracle instance `instance1`, type:

```
cd('oracle.as.management.mbeans.register:type=OID,name=oid1,instance=instance1')
```

7. Once you have navigated to the desired MBean, you can get the current value for an attribute by typing:

```
get('ATTRIBUTE_NAME')
```

For example, to get the value for `orclserverprocs`, type:

```
get('orcldebugflag')
```

8. Before you make any changes to attributes, you must ensure that the MBean has the current server configuration. To do that, load the configuration from Oracle Internet Directory server to the mbean. Type:

```
invoke('load', jarray.array([], java.lang.Object), jarray.array([], java.lang.String))
```

9. Then you can use the set command to set a specific attribute. Type:

```
set('ATTRIBUTE_NAME', ATTRIBUTE_VALUE)
```

For example, to set `orclserverprocs = 12`, type:

```
set('orcldebugflag', 12)
```

10. After making changes, you must save the MBean configuration to the Oracle Internet Directory server. Type:

```
invoke('save', jarray.array([], java.lang.Object), jarray.array([], java.lang.String))
```

Managing System Configuration Attributes by Using LDAP Tools

From the command line, you can modify most system configuration attributes by using `ldapmodify` and list most system configuration by using `ldapsearch`.

Setting System Configuration Attributes by Using `ldapmodify`

You can modify most attributes in [Table 9-1](#), [Table 9-2](#), and [Table 9-3](#) by using the command-line:

```
ldapmodify -D cn=orcladmin -q -p portNum -h hostname -f ldifFile
```

The contents of the LDIF file depends on the DN and the operation being performed.

The LDIF file for changing the value of the `orclgeneratechangelog` attribute in the instance-specific entry to 1 would be:

```
dn: cn=componentname,cn=osldapd,cn=subconfigsubentry
changetype: modify
replace: orclgeneratechangelog
orclgeneratechangelog: 1
```

The LDIF file for adding the `orclinmemfiltprocess` attribute to the DSA configuration entry would be:

```
dn: cn=dsconfig, cn=configsets, cn=oracle internet directory
changetype: modify
add: orclinmemfiltprocess
orclinmemfiltprocess: (objectclass=inetorgperson)(orclisenabled=TRUE)
```

Notes:

- In 11g Release 1 (11.1.1), consecutive settings of `orcldebugflag` and of `orcloptracklevel` are additive.
- Restart the server after changing `orclskiprefinsql`, `orclskewedattribute`, `orclserverprocs`, `orcldispthreads`, `orclmaxcc`, `orclpluginworkers`, or any attribute with a name that begins with "orclssl" or "orclsasl."
- After changing `orclnonsslport` or `orclsslport` by using LDAP tools or ODSM, restart the server and run `opmnctl updatecomponentregistration`, as described in ["Updating the Component Registration of an Oracle Instance by Using opmnctl"](#) on page 8-8.

See Also:

- The Oracle Internet Directory chapter of *Oracle Fusion Middleware Performance and Tuning Guide* for more examples of LDIF files
- The `ldapmodify` command-line tool reference in *Oracle Fusion Middleware Reference for Oracle Identity Management* for a more detailed discussion of `ldapmodify`, and a list of its options
- The "Oracle Identity Management LDAP Attribute Reference" in *Oracle Fusion Middleware Reference for Oracle Identity Management* for descriptions of the modifiable system configuration attributes.

Listing Configuration Attributes with ldapsearch

You can use `ldapsearch` to list most attributes.

Instance-Specific Configuration Entry

If the component name for a server instance is `oid1`, then you can list the attributes in the instance-specific configuration entry with a command line such as:

```
ldapsearch -p 3060 -h myhost.example.com -D cn=orcladmin -q \
  -b "cn=oid1,cn=osdldapd,cn=subconfigsentry" -s base "objectclass=*
```

DSA Configuration Entry

You can list the attributes with the command line:

```
ldapsearch -p 3060 -h myhost.example.com -D cn=orcladmin -q \
  -b "cn=dsaconfig,cn=configsets,cn=oracle internet directory" \
  -s base "objectclass=*
```

DSE

You can list the attributes with the command line:

```
ldapsearch -p 3060 -h myhost.example.com -D cn=orcladmin -q \
  -b "" -s base "objectclass=*
```

Managing System Configuration Attributes by Using ODSM Data Browser

Oracle Enterprise Manager Fusion Middleware Control is the recommended graphical user interface for managing system configuration attributes. You can also use ODSM to manage system configuration attributes, which can be useful if Fusion Middleware Control is not available or if you must modify an attribute that has no Fusion Middleware Control interface.

See "[Managing Entries by Using Oracle Directory Services Manager](#)" on page 13-1 for detailed instructions for changing the attributes of a directory entry. The following sections explain how to get to the entries that contain system configuration attributes in ODSM.

Navigating to the Instance-Specific Configuration Entry

On the Data Browser tab, in the navigation tree, expand `subconfigs`, then `osdlldapd`. Then select the name of the Oracle Internet Directory component you want to manage.

Navigating to the DSA Configuration Entry

On the Data Browser tab, in the navigation tree, expand `oracle internet directory`, then `configsets`, then select the entry `dsaconfig`.

Navigating to the DSE Root

On the Data Browser tab, click `Root` in the navigation tree to select the DSE.

Managing IP Addresses

This chapter discusses how to manage Oracle Internet Directory's IP addresses. It contains the following sections:

- [Introduction to Managing IP Addresses](#)
- [Configuring an IP Address for IP V6, Cold Failover Cluster, or Virtual IP](#)

Introduction to Managing IP Addresses

When you install Oracle Internet Directory on a dual stack (IPV4/IPV6) host, Oracle Internet Directory listens on both addresses. You cannot install Oracle Internet Directory on a host with only an IPV6 address because the Oracle Database requires an IPV4 address to connect to.

If you install Oracle Internet Directory on an IPV4 host and then change the host's address to IPV6, you must configure Oracle Internet Directory's IP address separately to the IPV6 address by changing the `orclhostname` attribute in the instance-specific configuration entry.

If you must have Oracle Internet Directory listen on a specific address for some other reason, you also do that by changing the `orclhostname` attribute in the instance-specific configuration entry.

Configuring an IP Address for IP V6, Cold Failover Cluster, or Virtual IP

Perform the following steps to configure Oracle Internet Directory to listen on a specific IP address:

1. Create an LDIF file similar to this:

```
dn: cn=COMPONENT_NAME, cn=osldapd, cn=subconfigsubentry
changetype: modify
replace: orclhostname
orclhostname: IP_address
```

2. Execute the following `ldapmodify` command:

```
ldapmodify -D cn=orcladmin -q -p portNum -h hostname -f ldifFile
```

3. Restart Oracle Internet Directory by using `opmnctl`, as follows:

```
opmnctl stopall
opmnctl startall
```

4. Update the registration of the Oracle Internet Directory component, as described in ["Updating the Component Registration of an Oracle Instance by Using opmnctl"](#) on page 8-8. For example:

```
$ORACLE_INSTANCE/bin/opmnctl updatecomponentregistration \  
-adminHost myhost \  
-adminPort 7001 \  
-adminUsername weblogic \  
-componentType OID \  
-componentName oid2\  
-Port 3061
```

If you fail to perform this step, you will be unable to use Fusion Middleware Control or `wlst` to manage that component.

You can also use ODSM to change the `orclhostname` attribute in the instance-specific configuration entry. See ["Managing System Configuration Attributes by Using ODSM Data Browser"](#) on page 9-18.

Managing Naming Contexts

To enable users to search for specific naming contexts, you can publish those naming contexts. This section contains these topics:

- [Introduction to Managing Naming Contexts](#)
- [Searching for Published Naming Contexts](#)
- [Publishing a Naming Context](#)

Introduction to Managing Naming Contexts

See "[Naming Contexts](#)" on page 3-14 for a description of naming contexts.

To publish a naming context, you specify the topmost entry of each naming context as a value of the `namingContexts` attribute in the root DSE. For example, suppose you have a DIT with three major naming contexts, the topmost entries of which are `c=uk`, `c=us`, and `c=de`. If these entries are specified as values in the `namingContexts` attribute, then a user, by specifying the appropriate filter, can find information about them by searching the root DSE. The user can then focus the search—for example, by concentrating on the `c=de` naming context in particular.

Searching for Published Naming Contexts

To search for published naming contexts, perform a base search on the root DSE with `objectClass =*` specified as a search filter. The retrieved information includes those entries specified in the `namingContexts` attribute. For example:

```
ldapsearch -p 3060 -q -D cn=orcladmin -b "" -s base -L "objectclass=*" \  
namingcontexts
```

Note: This command will not return anything unless naming contexts have been published.

Before you publish a naming context, be sure that:

- You are a directory administrator with the necessary access to the root DSE.
- The topmost entry of that naming context exists in the directory.

Publishing a Naming Context

You use `ldapmodify` to publish a naming context. The `namingContexts` attribute is multi-valued, so you can specify multiple naming contexts.

You can modify `namingContexts` by using the command-line:

```
ldapmodify -D cn=orcladmin -q -p portNum -h hostname -f ldifFile
```

The following sample LDIF file specifies the entry `c=uk` as a naming context.

```
dn:  
changetype: modify  
add: namingcontexts  
namingcontexts: c=uk
```

Managing Accounts and Passwords

This chapter contains these topics:

- [Introduction to Managing Accounts and Passwords](#)
- [Managing Accounts and Passwords by Using Command-Line Tools](#)
- [Managing Accounts and Passwords by Using the Self-Service Console](#)
- [Listing and Unlocking Locked Accounts by Using Oracle Directory Services Manager](#)
- [Changing the Superuser Password by Using Fusion Middleware Control](#)
- [Creating Another Account With Superuser Privileges](#)
- [Managing the Superuser Password by Using Idapmodify](#)
- [Changing the Oracle Internet Directory Database Password](#)
- [Changing the Password for the EMD Administrator Account](#)
- [Changing the Password for the ODSSM Administrator Account](#)

Introduction to Managing Accounts and Passwords

This chapter describes some administrative tasks related to accounts and passwords.

See Also:

- [Chapter 13, "Managing Directory Entries"](#)
- [Chapter 28, "Managing Password Policies"](#)
- ["Changing the Replication Administrator's Password for Advanced Replication" on page 41-26](#)

Note: All references to the Self-Service console in this chapter refer to the console included with Oracle Delegated Administration Services 10g (10.1.4.3.0) or later, which is compatible with Oracle Internet Directory 11g Release 1 (11.1.1). See *Oracle Identity Management Guide to Delegated Administration* in the 10g (10.1.4.0.1) Library for more information.

Using command-line tools or the Self-Service console, you can temporarily disable a user's account, then enable it again. If you are a member of the Security Administrators Group, then you can unlock an account without resetting the user

password. This saves you from having to explicitly tell the user the new password. The user can simply log in using the old password.

Using command-line tools, you can force users to change their passwords when they log in for the first time.

If you forget your password or become locked out of your account, then you can reset your password. You do this by using the Self-Service Console. This involves identifying yourself to the server by providing values for a set of password validation attributes. This takes the form of answering a password hint question to which you had earlier specified an answer.

The Superuser is a special directory administrator with full access to directory information. The default user name of the superuser is `orcladmin`. The password is set by the administrator during installation.

Note: Oracle recommends that you change the password immediately after installation.

You can use either Oracle Enterprise Manager or `ldapmodify` to administer the Superuserpassword.

See Also: [Chapter 29, "Managing Directory Access Control"](#) for information on how to set access rights

Another privileged account is the administrator, "`cn=emd admin,cn=oracle internet directory`". This account is used for starting and stopping Oracle Internet Directory server manageability information collection. It is also used by Oracle Enterprise Manager Fusion Middleware Control to make configuration changes to Oracle Internet Directory. These changes are made over a secure connection.

The only way you can change this account's password is to use the procedure documented in "[Changing the Password for the EMD Administrator Account](#)" on page 12-7. There is no support in the `oidpasswd` tool for changing this password.

Managing Accounts and Passwords by Using Command-Line Tools

This section contains these topics:

- [Enabling and Disabling Accounts by Using Command-Line Tools](#)
- [Unlocking Accounts by Using Command-Line Tools](#)
- [Forcing a Password Change by Using Command-Line Tools](#)

Enabling and Disabling Accounts by Using Command-Line Tools

You can temporarily disable a user's account, then enable it again, by using command-line tools.

To permanently disable the account, set the `orclisEnabled` attribute to `DISABLED`. Setting this attribute to any other value enables the account.

To enable the account after you have disabled it, delete this attribute from the entry.

To enable the account for a specific period, set the `orclActiveStartDate` and `orclActiveEndDate` attributes in the user entry to the proper value in UTC (Coordinated Universal Time) format. For example, you could use a command line such as:

```
ldapmodify -p port -h host -D cn=orcladmin -q -v -f my.ldif
```

where my.ldif contains:

```
dn:cn=John Doe,cn=users,o=my_company,dc=com
orclactivestartdate:20030101000000z
orclactiveenddate: 20031231000000z
```

In this example, John Doe can log in only between January 1, 2003 and December 31, 2003. He cannot login before January 1, 2003 or after December 31, 2003. If you want to disable his account for the period between these dates, then set the `orclisenabled` attribute to `DISABLED`.

Unlocking Accounts by Using Command-Line Tools

If you are a member of the Security Administrators Group, then you can unlock an account without resetting the user password. This saves you from having to explicitly tell the user the new password. The user can simply log in using the old password.

To unlock an account, set the `orclpwdaccountunlock` attribute to 1.

The following example unlocks the account for user John Doe.

```
ldapmodify -p port -h host -D cn=orcladmin -q -v -f file.ldif
```

where file.ldif contains:

```
dn: cn=John Doe,cn=users,o=my_company,dc=com
changetype: modify
add: orclpwdaccountunlock
orclpwdaccountunlock: 1
```

Forcing a Password Change by Using Command-Line Tools

You can force users to change their passwords when they log in for the first time. To do this, set the `pwdMustChange` attribute in the `pwdpolicy` entry to 1, and then reset the password. If you do this, you must explicitly tell the user the new password so that the user can log in to change that password.

See Also:

- ["Resetting Your Own Password by Using the Oracle Internet Directory Self-Service Console"](#) on page 12-4 for instructions on resetting passwords
- ["Setting Password Policies by Using Command-Line Tools"](#) on page 28-12 for instructions on setting attributes of a password policy

Managing Accounts and Passwords by Using the Self-Service Console

For administrators, Oracle Directory Services Manager is the primary tool for managing users and passwords.

You can also use Oracle Identity Manager to centralize user and account provisioning to Oracle Internet Directory 11g Release 1 (11.1.1). For end user self-service, Oracle Identity Manager is the recommended solution. The Oracle Identity Manager documentation is available on Oracle Technology Network at:

<http://www.oracle.com/technology/documentation/oim.html>

Customers who already have Oracle Delegated Administration Services in their environment can use it for end user self-service with Oracle Internet Directory 11g Release 1 (11.1.1). However, 10g is the terminal release for Oracle Delegated Administration Services, and the component is deprecated in 11g and later releases.

This section contains these topics:

- [Enabling and Disabling Accounts by Using the Oracle Internet Directory Self-Service Console](#)
- [Unlocking Accounts by Using the Oracle Internet Directory Self-Service Console](#)
- [Resetting Your Own Password by Using the Oracle Internet Directory Self-Service Console](#)

Enabling and Disabling Accounts by Using the Oracle Internet Directory Self-Service Console

You can temporarily disable a user's account, then enable it again, by using the Oracle Internet Directory Self-Service Console.

See Also: The section on managing accounts in *Oracle Identity Management Guide to Delegated Administration* in the 10g (10.1.4.0.1) library for instructions on enabling and disabling accounts by using the Oracle Internet Directory Self-Service Console

Unlocking Accounts by Using the Oracle Internet Directory Self-Service Console

If you are a member of the Security Administrators Group, then, if an account becomes locked, you can unlock it without resetting the user password. This saves you from having to explicitly tell the user the new password. The user can simply log in by using the old password.

See Also: The section on managing accounts in *Oracle Identity Management Guide to Delegated Administration* in the 10g (10.1.4.0.1) library for instructions on using the Oracle Internet Directory Self-Service Console to unlock accounts

Resetting Your Own Password by Using the Oracle Internet Directory Self-Service Console

If you forget your password or become locked out of your account, then you can reset your password. This involves identifying yourself to the server by providing values for a set of password validation attributes. This takes the form of answering a password hint question to which you had earlier specified an answer.

See Also: The section on resetting your password if you forget it in *Oracle Identity Management Guide to Delegated Administration* in the 10g (10.1.4.0.1) library for instructions on using the Oracle Internet Directory Self-Service Console to reset your password

Listing and Unlocking Locked Accounts by Using Oracle Directory Services Manager

You can use Oracle Directory Services Manager to list and unlock locked accounts.

1. Invoke Oracle Directory Services Manager as described in "[Invoking Oracle Directory Services Manager](#)" on page 7-9, and

2. From the task selection bar, select **Data Browser**.
3. Perform a simple search, as described in ["Searching for Entries by Using Oracle Directory Services Manager"](#) on page 13-3, using the search string (`pwdaccountlockedtime=*`). A list of entries with locked accounts appears.
4. Select the entry whose account you want to unlock.
5. When an account is locked, **Unlock Account** appears before the **Apply** and **Revert** buttons. Click **Unlock Account**.

Changing the Superuser Password by Using Fusion Middleware Control

To change the password for the superuser by using Oracle Enterprise Manager Fusion Middleware Control:

1. Select **Administration**, then **Shared Properties** from the **Oracle Internet Directory** menu.
2. Click the **Change Superuser Password** tab.
3. Specify the old password.
4. Specify the new password.
5. Confirm the new password.
6. Click **Apply**.

Table 12–1 Configuration Attributes on Shared Properties, Change Superuser Password Tab.

Field or Heading	Configuration Attribute
Superuser Password	orclsupassword

The configuration attribute `orclsupassword` is an attribute of the DSE root.

Creating Another Account With Superuser Privileges

The Superuser, `cn=orcladmin`, gets its privileges from membership in several privileged groups. You can query for those groups by using the following `ldapsearch` command:

```
ldapsearch -h host -p port -D "cn=orcladmin" -q -b "" -L \
-s sub "(|(uniquemember=cn=orcladmin)(member=cn=orcladmin))" dn
```

To create a second account with Superuser privilege, create another user entry that belongs to the same groups. Also add the user as member of the group `cn=directoryadmingroup,cn=oracle internet directory`.

After you have created additional users with Superuser privileges, you no longer need to use `cn=orcladmin` to administer Oracle Internet Directory. The privileged accounts should be sufficient. The attribute `orclsunname`, however, must have the value `cn=orcladmin`.

See Also: [Chapter 13, "Managing Directory Entries"](#) to learn how to create a user entry and [Chapter 14, "Managing Dynamic and Static Groups"](#) to learn how to add a user to a group.

Note: To maintain system security, keep the number of privileged users to a minimum and ensure that all privileged accounts are audited. See [Chapter 22, "Managing Auditing."](#)

Managing the Superuser Password by Using ldapmodify

You should never change the Superuser's name. The value of `orclsuname` must remain `cn=orcladmin`

To set or modify the password for the superuser, use `ldapmodify` to modify the attribute `orclsuname` or `orclsupassword`, respectively, in the DSE root. Changing the user name of the superuser can have serious repercussions and is not recommended.

To change the password of the superuser to `superuserpassword`, use an LDIF file such as the following:

```
dn:  
changetype:modify  
replace:orclsupassword  
orclsupassword:superuserpassword
```

See Also: The `ldapmodify` command-line tool reference in *Oracle Fusion Middleware Reference for Oracle Identity Management* for `ldapmodify` syntax and usage notes.

Changing the Oracle Internet Directory Database Password

The Oracle Internet Directory uses a password when connecting to its own designated Oracle database. The default for this password when you install Oracle Internet Directory is the same as that for the Oracle Fusion Middleware administrator. You can change this password by using `oidpasswd`.

The following example shows how to change the Oracle Internet Directory database password, assuming the database is on the same machine.

```
oidpasswd connect=dbs1 change_oiddb_pwd=true  
current password: oldpassword  
new password: newpassword  
confirm password: newpassword  
password set.
```

See Also: The `oidpasswd` command-line tool reference in *Oracle Fusion Middleware Reference for Oracle Identity Management*

Note: The account described here is different from the ODSSM account used for accessing server manageability information. "[Account Used for Accessing Server Manageability Information](#)" on page 24-4 describes that account. For information about changing that account, see "[Changing the Password for the ODSSM Administrator Account](#)" on page 12-8.

Resetting the Superuser Password

If you forget the Oracle Internet Directory superuser (`cn=orcladmin`) password, you can use the `oidpasswd` tool to reset it. You must provide the Oracle Internet Directory database password. When you first install Oracle Internet Directory, the superuser password and Oracle Internet Directory database password are the same. After installation, however, you can change the Oracle Internet Directory superuser password using `ldapmodify`. If you forget the Oracle Internet Directory superuser password, you can reset it using the `oidpasswd` tool separately.

The following example shows how to reset the Oracle Internet Directory superuser password. The `oidpasswd` tool prompts you for the Oracle Internet Directory database password.

Example:

```
oidpasswd connect=dbs1 reset_su_password=true
OID DB user password: oid_db_password
    password: new_su_password
confirm password: new_su_password
OID superuser password reset successfully
```

Changing the Password for the EMD Administrator Account

The EMD administrator account, "`cn=emd admin,cn=oracle internet directory`", has very limited privilege and is used primarily by for starting and stopping Oracle Internet Directory server manageability information collection.

See Also: [Chapter 24, "Monitoring Oracle Internet Directory"](#) for information about Oracle Internet Directory server manageability information collection.

To change the password for the EMD administrator, you must change it in Oracle Internet Directory, then change it on both the WebLogic domain server and on each Oracle instance in the domain. Use the following procedure:

1. Change the `userpassword` of the account "`cn=emd admin,cn=oracle internet directory`" in Oracle Internet Directory by using `ldapmodify`.

2. Invoke `wlst` and connect to the WebLogic server.

```
java weblogic.WLST
connect('weblogic', 'weblogic_user_password', 'protocol:host:port')
```

3. Run the following WLST command:

```
updateCred(map='emd',keu='EMD_instance_name',
password='newpassword',user='EMD')
```

4. On each Oracle instance in the WebLogic domain, execute the following command line:

```
ORACLE_HOME/ldap/bin/oidcred emd update [instanceName]
```

5. Update the component registration of the Oracle instance, as described in ["Updating the Component Registration of an Oracle Instance by Using `opmnctl`"](#) on page 8-8

Changing the Password for the ODSSM Administrator Account

Oracle Internet Directory connects to its Oracle Database, using the password specified for the ODS schema during schema creation. It also connects to retrieve its metrics using the ODSSM schema password, given during schema creation as well.

The Oracle Enterprise Manager Fusion Middleware Control default password, at the end of install, is the same as the ODSSM password.

To change the password for the ODSSM administrator, you must change it in the Oracle Database and then change it on both the WebLogic domain server and on each Oracle instance in the domain. Use the following procedure:

1. Use SQLPlus or a similar tool to alter the password in the database.
2. Go to `ORACLE_HOME/common/bin` and run the following command:

```
sh wlst.sh
```

3. Connect to the WebLogic Administration Server:

```
connect('weblogic_username','pwd','t3://host:port')
```

4. Run the `updateCred()` command:

```
updateCred(map='odssm', key='ODSSM_instance_name', password='newpassword',  
user='ODSSM')
```

where `instance_name` is the instance name provided during installation, for example, `asinst_1`.

5. On each Oracle instance in the WebLogic domain, execute the following command line:

```
ORACLE_HOME/ldap/bin/oidcred odssm update [instance_name]
```

6. Update the component registration of the Oracle instance, as described in ["Updating the Component Registration of an Oracle Instance by Using opmnctl"](#) on page 8-8.

If Oracle Directory Integration Platform is also configured in the instance, then you must update this new ODSSM password in one additional place. Proceed as follows:

1. Log in to the WebLogic Administration console at:

```
http://host:port/console
```

2. Select **Data Sources** -> **schedulerDS** -> **Connection Pool**.

3. Click **Lock & Edit** in the top left corner of the screen.

4. Enter the new password in the **Password** and **Confirm Password** fields.

Click **Save**.

5. Click **Activate Changes**.

Managing Directory Entries

This chapter contains these topics:

- [Introduction to Managing Directory Entries](#)
- [Managing Entries by Using Oracle Directory Services Manager](#)
- [Managing Entries by Using LDAP Command-Line Tools](#)

Introduction to Managing Directory Entries

The primary function of most directories is to store information about users and return that information in response to requests. Applications that request information from the directory server are called clients of the server.

As administrator, you manage users, groups, and other types of entries by using Oracle Directory Services manager or the command-line tools.

See Also: [Chapter 3, "Understanding Oracle Internet Directory Concepts and Architecture,"](#) for introductory information about entries, object classes, and attributes.

Managing Entries by Using Oracle Directory Services Manager

You display entries, including users and groups, by using the Data Browser in Oracle Directory Services Manager.

The current chapter focuses on users and other types of entries. [Chapter 14, "Managing Dynamic and Static Groups"](#) discusses groups and group entries in more detail.

This section contains these topics:

- [Displaying Entries by Using Oracle Directory Services Manager](#)
- [Searching for Entries by Using Oracle Directory Services Manager](#)
- [Importing Entries from an LDIF File by Using Oracle Directory Services Manager](#)
- [Exporting Entries to an LDIF File by Using Oracle Directory Services Manager](#)
- [Viewing Attributes for a Specific Entry by Using Oracle Directory Services Manager](#)
- [Deleting an Entry or Subtree by Using Oracle Directory Services Manager](#)
- [Adding a New Entry by Using Oracle Directory Services Manager](#)
- [Adding an Entry by Copying an Existing Entry in Oracle Directory Services Manager](#)

- [Modifying an Entry by Using Oracle Directory Services Manager](#)

See Also:

- ["Adding or Modifying an ACP by Using the Data Browser in ODSM"](#) on page 21
- ["Setting or Modifying Entry-Level Access by Using the Data Browser in ODSM"](#) on page 21







for information on setting or modifying access control on an entry.

Displaying Entries by Using Oracle Directory Services Manager



To display entries by using the Data Browser in Oracle Directory Services Manager proceed as follows:

1. Invoke Oracle Directory Services Manager and connect to the Oracle Internet Directory server as described in ["Invoking Oracle Directory Services Manager"](#) on page 7-9.
2. From the task selection bar, select **Data Browser**.
3. If desired, expand items in the data tree in the left panel to view the entries in each subtree.

Entries of some object class types have generic icons in the data tree. Others are shown with a specific icon. For example:

Object Class	Icon
User	
Group	
OrganizationalUnit	
Organization	
Domain	
Country	
Generic	

When an access control list (ACL) has been set on an entry, the icon changes; a small key appears to the right of the icon. For example:

Object Class	Icon with ACL
User	
Group	

See Also: [Chapter 29, "Managing Directory Access Control."](#)

4. If desired, mouse over each icon in the tool bar to read the icon's action.

5. Select the **Refresh the entry** icon to refresh only the entry in the right pane. Select the **Refresh subtree entries** icon to refresh child entries of the selected entry.
6. To limit the number of entries displayed in a subtree, select the entry at the root of the subtree, then click the **Filter child entries** icon and specify a filter, as follows:
 - a. In the Max Results field, specify a number from 1 to 1000, indicating the maximum number of entries to return.
 - b. From the list at the left end of the search criteria bar, select an attribute of the entries you want to view.
 - c. From the list in the middle of the search criteria bar, select a filter.
 - d. In the text box at the right end of the search criteria bar, type the value for the attribute you just selected. For example, if the attribute you selected was `cn`, you could type the particular common name you want to find.
 - e. Click **+** to add this search criterion to the **LDAP Query** field.
 - f. To view the LDAP filter you have selected, select **Show LDAP filter**.
 - g. To further refine your search, use the list of conjunctions (**AND**, **OR**, **NOT AND**, and **NOT OR**) and the lists and text fields on the search criteria bar to add additional search criteria. Click **+** to add a search criterion to the **LDAP Query** field. Click **X** to delete a search criterion from the **LDAP Query** field.
7. When you have finished configuring the search criteria, click **OK**. The child entries that match the filter are shown under the selected entry. The filter is applied for first level children only, not for the entire subtree. Click the **Refresh** icon to remove the filter.

Searching for Entries by Using Oracle Directory Services Manager

To search for a directory entry:

1. Invoke Oracle Directory Services Manager as described in "[Invoking Oracle Directory Services Manager](#)" on page 7-9.
2. From the task selection bar, choose **Data Browser**.
3. To perform a simple keyword search, enter text in the field next to the Search icon to specify keywords to search for in the attributes `cn`, `uid`, `sn`, `givenname`, `mail` and `initials`.
4. Click the **Simple Search** arrow to the right of the text field or press the Enter key. Search results, if any, are displayed below the data tree. Click the information icon to view information about this search. Click the **Refresh the search results entries** icon to refresh the results. Click the **Close search result** icon to dismiss the search.
5. To perform a more complex search, click **Advanced**. The Search Dialog appears.
6. In the **Root of the Search** field, enter the DN of the root of your search.

For example, suppose you want to search for an employee who works in the Manufacturing division in the IMC organization in the Americas. The DN of the root of your search would be:

```
ou=Manufacturing,ou=Americas,o=IMC,c=US
```

You would therefore type that DN in the **Root of the Search** text box.

You can also select the root of your search by browsing the data tree. To do this:

- a. Click **Browse** to the right of the **Root of the Search** field. The Select Distinguished Name (DN) Path: Tree View dialog box appears.
 - b. Expand an item in the tree view to display its entries.
 - c. Continue navigating to the entry that represents the level you want for the root of your search.
 - d. Select that entry, then click **OK**. The DN for the root of your search appears in the **Root of the Search** text box in the right pane.
7. In the **Max Results (entries)** box, type the maximum number of entries you want your search to retrieve. The default is 200. The directory server retrieves the value you set, up to 1000.
 8. In the **Max Search Time (seconds)** box, type the maximum number of seconds for the duration of your search. The value you enter here must be at least that of the default, namely, 25. The directory server searches for the amount of time you specify, up to one hour.
 9. In the **Search Depth** list, select the level in the DIT to which you want to search. The options are:
 - **Base:** Retrieves a particular directory entry. Along with this search depth, you use the search criteria bar to select the attribute `objectClass` and the filter `Present`.
 - **One Level:** Limits your search to all entries beginning one level down from the root of your search.
 - **Subtree:** Searches entries within the entire subtree, including the root of your search. This is the default.
 10. Set search criteria.

Optionally, select Show LDAP filter, then type a query string directly into the **LDAP Query** text field.

Alternatively, use the lists and text fields on the search criteria bar to focus your search.

- a. From the list at the left end of the search criteria bar, select an attribute of the entry for which you want to search. Because not all attributes are used in every entry, be sure that the attribute you specify actually corresponds to one in the entry for which you are looking. Otherwise, the search fails.
 - b. From the list in the middle of the search criteria bar, select a filter.
 - c. In the text box at the right end of the search criteria bar, type the value for the attribute you just selected. For example, if the attribute you selected was `cn`, you could type the particular common name you want to find.
 - d. Click **+** to add this search criterion to the **LDAP Query** field.
 - e. To view the LDAP filter you have selected, select **Show LDAP filter**.
 - f. To further refine your search, use the list of conjunctions (**AND**, **OR**, **NOT AND**, and **NOT OR**) and the lists and text fields on the search criteria bar to add additional search criteria. Click **+** to add a search criterion to the **LDAP Query** field. Click **X** to delete a search criterion from the **LDAP Query** field.
11. Click **Search**. Search results, if any, are displayed below the data tree. If an **LDAP error** icon appears, mouse over it to see the error. Search again with different criteria, if necessary, to correct the error. Click the Search Filter icon to see

information about the search. Click the **Refresh the search result entries** icon to refresh the results. You can delete the search results by clicking the **Close search result** icon.

See Also: "[Viewing Active Server Instance Information by Using opmnctl](#)" on page 8-9 For instructions on setting the number of entries to display in searches, and to set the time limit for searches

Importing Entries from an LDIF File by Using Oracle Directory Services Manager

You can import entries from an LDIF file, as follows:

1. Invoke Oracle Directory Services Manager and connect to the Oracle Internet Directory server as described in "[Invoking Oracle Directory Services Manager](#)" on page 7-9.
2. Click the Data Browser tab.
3. Click the **Import LDIF** icon. The Import File dialog appears.
4. Enter the path to the LDIF file you want to import, or click **Browse** and navigate to the file, then click **Open** in the browser window.
5. Click **OK** in the Import File dialog. The LDIF Import Progress window shows the progress of the operation. Expand View Import Progress Table to see detailed progress.

Click **Cancel** to stop importing entries. Entries already imported are not aborted.

The Data Browser tree refreshes to show the new entries.

Exporting Entries to an LDIF File by Using Oracle Directory Services Manager

You can export entries to an LDIF file, as follows:

1. Invoke Oracle Directory Services Manager and connect to the Oracle Internet Directory server as described in "[Invoking Oracle Directory Services Manager](#)" on page 7-9.
2. Click the Data Browser tab.
3. Navigate to the top level DN of the subtree you want to export.
4. Click the **Export LDIF** icon. The Export File dialog appears. Select Export Operational Attributes if you want to export them.
5. Click **OK**. The Download LDIF File dialog appears. By default, the entries are exported to a temporary file on the machine where Oracle Directory Services Manager is deployed. If you want to save a copy of the LDIF file to your computer, click **Click here to open the LDIF file** and save the file.

Click **OK**.

Viewing Attributes for a Specific Entry by Using Oracle Directory Services Manager

You can view the attributes for a specific entry as follows:

1. Invoke Oracle Directory Services Manager and connect to the Oracle Internet Directory server as described in "[Invoking Oracle Directory Services Manager](#)" on page 7-9.

2. Locate the entry by navigating to it in the data tree or by searching for it, as described in ["Searching for Entries by Using Oracle Directory Services Manager"](#) on page 13-3.
3. Click the entry. Attributes for that entry are displayed in the right pane. The display for the entry has at least the three tabs: **Attributes**, **Subtree Access**, and **Local Access**. If the entry is a person, the display in the right pane also has an **Person** tab, which displays basic user information. If the entry is a group, the display screen has a **Group** tab, which displays basic group information.
4. To view the attributes of an entry, click the **Attributes** tab.
5. You can switch between Managed Attributes and Show All by using the **Views** list.
6. To change the list of attributes shown as managed attributes, click the icon under **Optional Attributes**. Select attributes you want to move from the All Attributes list to the Shown Attributes lists and use the **Move** and **Move All** arrows to move the attributes. Select attributes you want to move from the shown Attributes list to the All Attributes lists and use the **Remove** and **Remove All** arrows to move the attributes. Click **Add Attributes** to make your changes take effect or click **Cancel** to discard your changes. After you click **Add Attributes**, only the attributes that were on the Shown Attributes list are shown in the Managed Attributes view.
7. For information on using the Subtree Access and Local Access tabs to view access control settings, see ["Adding or Modifying an ACP by Using the Data Browser in ODSM"](#) on page 29-21.

Adding a New Entry by Using Oracle Directory Services Manager

To add or delete entries with Oracle Directory Services Manager, you must have write access to the parent entry and you must know the DN to use for the new entry.

Note: When you add or modify an entry, the Oracle directory server does not verify the syntax of the attribute values in the entry.

To add a group entry, follow the procedure described in ["Managing Group Entries by Using Oracle Directory Services Manager"](#) on page 14-8. For other entry types, proceed as follows:

1. Invoke Oracle Directory Services Manager and connect to the Oracle Internet Directory server as described in ["Invoking Oracle Directory Services Manager"](#) on page 7-9.
2. From the task selection bar, select **Data Browser**.
3. On the toolbar, select the **Create a new entry** icon. Alternatively, right click any entry and choose **Create**.

The Create New Entry wizard appears.

4. Specify the object classes for the new entry. Click the **Add** icon and use the Add Object Class dialog to select object class entries. Optionally, use the search box to filter the list of object classes. To add the object class, select it and then click **OK**. (All the superclasses from this object class through `top` are also added.)

Note: You must assign user entries to the `inetOrgPerson` object class in order for the entries to appear in the Oracle Internet Directory Self-Service Console in Oracle Delegated Administration Services.

5. In the **Parent of the entry** field, you can specify the full DN of the parent entry of the entry you are creating. You can also click **Browse** to locate and select the DN of the parent for the entry you want to add. If you leave the **Parent of the entry** field blank, the entry is created under the root entry.
6. Click **Next**.
7. Choose an attribute which will be the **Relative Distinguished Name** value for this entry and enter a value for that attribute. You must enter values for attributes that are required for the object class you are using, even if none of them is the RDN value. For example, for object class `inetorgperson`, attributes `cn` (common name) and `sn` (surname or last name) are required, even if neither of them is the Relative Distinguished Name value.
8. Click **Next**. The next page of the wizard appears. (Alternatively, you can click **Back** to return to the previous page.)
9. Click **Finish**.
10. To manage optional attributes, navigate to the entry you have just created in the Data Tree
11. If the entry is a person, click the **Person** tab and use it to manage basic user attributes. Click **Apply** to save your changes or **Revert** to discard them.
If the entry is a group, see "[Managing Group Entries by Using Oracle Directory Services Manager](#)" on page 14-8.
12. If this is a person entry, you can upload a photograph. Click **Browse**, navigate to the photograph, then click **Open**. To update the photograph, click **Update** and follow the same procedure. Click the **Delete** icon to delete the photograph.
13. To manage object classes, as well as attributes that are not specific to a person or group entry, click the **Attributes** tab.
14. To add an object class:
 - a. Click the **Attributes** tab.
 - b. Click the **Add** icon next to `objectclass` and use the Add Object Class dialog to select object class entries. Optionally, use the search box to filter the list of object classes. To add the object class, click it and then click **OK**.
15. To delete an object class,
 - a. Click the **Attributes** tab.
 - b. Select the object class you want to delete.
 - c. Click the **Delete** icon next to `objectclass`. The Delete Object Class dialog lists the attributes that will be deleted with that class.
 - d. Click **Delete** to proceed.
16. By default, only non-empty attributes are shown. You can switch between **Managed Attributes** and **Show All** by using the **Views** list.
17. To change the list of attributes shown as managed attributes, click the icon under **Optional Attributes**. Select attributes you want to move from the All Attributes

list to the Shown Attributes lists and use the **Move** and **Move All** arrows to move the attributes. Select attributes you want to move from the shown Attributes list to the All Attributes lists and use the **Remove** and **Remove All** arrows to move the attributes. Click **Add Attributes** to make your changes take effect or click **Cancel** to discard your changes. After you click **Add Attributes**, only the attributes that were on the Shown Attributes list are shown in the Managed Attributes view.

18. Specify values for the optional properties. You can also modify the values of the mandatory properties. For multivalued attributes, you can use the **Add** and **Delete** icons to add and delete multiple values.
19. Click **Apply** to save your changes or **Revert** to discard them.
20. For information on using the Subtree Access and Local Access tabs to set access control, see ["Adding or Modifying an ACP by Using the Data Browser in ODSM"](#) on page 29-21.

Deleting an Entry or Subtree by Using Oracle Directory Services Manager

You can delete an entry, including an entire subtree, as follows:

1. Invoke Oracle Directory Services Manager and connect to the Oracle Internet Directory server as described in ["Invoking Oracle Directory Services Manager"](#) on page 7-9.
2. From the task selection bar, select **Data Browser**.
3. Navigate to the entry you want to delete.
4. To delete only the entry, click the **Delete** icon. When the Delete dialog appears, click **Yes**. If the entry has no subentries, deletion succeeds. If the entry has subentries, the deletion fails and ODSM displays an error message. Click **OK** to dismiss the error message.

To delete an entire subtree, click the icon labelled **Delete the selected entry and its subtree**. When the Delete Subtree dialog appears, read the contents of the dialog. Click **Yes** to proceed with the deletion or **No** to abort.

Adding an Entry by Copying an Existing Entry in Oracle Directory Services Manager

You can use Oracle Directory Services Manager to create a new entry by copying from an existing entry and changing its DN. When you do this, you should also change the attributes, such as name and address, so that they correspond with the new DN. To add an entry, you must have write access to its parent.

Tip: You can find a template for the new DN by looking up other similar entries in the search pane.

To add a group entry, follow the procedure described in ["Managing Group Entries by Using Oracle Directory Services Manager"](#) on page 14-8. For other entry types, proceed as follows:

1. Invoke Oracle Directory Services Manager and connect to the Oracle Internet Directory server as described in ["Invoking Oracle Directory Services Manager"](#) on page 7-9.
2. From the task selection bar, select **Data Browser**.
3. In the data tree, navigate to the entry you want to use as a template. Alternatively, click **Advanced Search**, and use it to search for an entry that you want to use as a template.

4. In the left panel, click the **Create a new entry like this one** icon. Alternatively, click the entry you want to use as a template, right click, and choose **Create Like**. A **New Entry: Create Like** wizard appears. The object classes and the DN of the parent entry are already filled in.
5. To add an object class:
 - a. Click the **Attributes** tab.
 - b. Click the **Add** icon next to `objectclass` and use the Add Object Class dialog to select object class entries. Optionally, use the search box to filter the list of object classes. To add the object class, click it and then click **OK**.
6. To delete an object class,
 - a. Click the **Attributes** tab.
 - b. Select the object class you want to delete.
 - c. Click the **Delete** icon next to `objectclass`. The Delete Object Class dialog lists the attributes that will be deleted with that class.
 - d. Click **Delete** to proceed.
7. Specify the DN of the parent entry, either by changing the content in the text box or by using the **Browse** button to locate a different DN.
8. Click **Next**. The next page of the wizard appears.
9. Choose an attribute which will be the **Relative Distinguished Name** value for this entry and enter a value for that attribute. You must enter values for attributes that are required for the object class you are using, even if none of them is the RDN value. For example, for object class `inetorgperson`, attributes `cn` (common name) and `sn` (surname or last name) are required, even if neither of them is the Relative Distinguished Name value.
10. Click **Next**.
11. Click **Finish**.
12. To manage optional attributes, navigate to the entry you have just created in the Data Tree, then proceed to Step 11 in "[Adding a New Entry by Using Oracle Directory Services Manager](#)" on page 13-6.

Modifying an Entry by Using Oracle Directory Services Manager

You can add auxiliary object classes to an existing entry.

Note: When you add or modify an entry, the Oracle directory server does not verify the syntax of the attribute values in the entry.

To modify a group entry, follow the procedure described in "[Managing Group Entries by Using Oracle Directory Services Manager](#)" on page 14-8. For other entry types, proceed as follows:

1. Invoke Oracle Directory Services Manager and connect to the Oracle Internet Directory server as described in "[Invoking Oracle Directory Services Manager](#)" on page 7-9.
2. From the task selection bar, select **Data Browser**.

3. Navigate to an entry in the data tree. Alternatively, perform a search for the entry you want to modify as described in ["Searching for Entries by Using Oracle Directory Services Manager"](#) on page 13-3. In the search result in the left pane, select the entry you want to modify.
4. To edit the RDN, select the **Edit RDN** icon above the Data Tree. Alternatively, you can select the entry in the Data Tree, right click, and select **Edit RDN**.
Specify the new RDN value. For a multivalued RDN you can use the **Delete Old RDN** checkbox to specify whether the old RDN should be deleted. Select **OK** to save the change or **Cancel** to abandon the change.
5. To add an object class:
 - a. Click the **Attributes** tab.
 - b. Click the **Add** icon next to `objectclass` and use the Add Object Class dialog to select object class entries. Optionally, use the search box to filter the list of object classes. To add the object class, click it and then click **OK**.
6. To delete an object class,
 - a. Click the **Attributes** tab.
 - b. Select the object class you want to delete.
 - c. Click the **Delete** icon next to `objectclass`. The Delete Object Class dialog lists the attributes that will be deleted with that class.
 - d. Click **Delete** to proceed or **Cancel** to cancel the deletion.
7. If the entry is a person, click the **Person** tab and use it to manage basic user attributes. Click **Apply** to save your changes or **Revert** to discard them.
If the entry is a group, see ["Managing Group Entries by Using Oracle Directory Services Manager"](#) on page 14-8.
8. If this is a person entry, you can upload a photograph. Click **Browse**, navigate to the photograph, then click **Open**. To update the photograph, click **Update** and follow the same procedure. Click the **Delete** icon to delete the photograph.
9. To modify the values of attributes that are not specific to a person or group, click the **Attributes** tab in the right pane and make the desired changes.
By default, only non-empty attributes are shown. You can switch between **Managed Attributes** and **Show All** by using the **Views** list.
10. To change the list of attributes shown as managed attributes, click the icon under **Optional Attributes**. Select attributes you want to move from the All Attributes list to the Shown Attributes lists and use the **Move** and **Move All** arrows to move the attributes. Select attributes you want to move from the shown Attributes list to the All Attributes lists and use the **Remove** and **Remove All** arrows to move the attributes. Click **Add Attributes** to make your changes take effect or click **Cancel** to discard your changes. After you click **Add Attributes**, only the attributes that were on the Shown Attributes list are shown in the Managed Attributes view.
11. Specify values for the optional properties. You can also modify the values of the mandatory properties. For multivalued attributes, you can use the **Add** and **Delete** icons to add and delete multiple values.
12. When you have completed all your changes, click **Apply** to make them take effect. Alternatively, click **Revert** to abandon your changes.
13. You can set an access control point (ACP) on this entry by using the Subtree Access and Local Access tabs. The procedures are described in ["Adding or Modifying an](#)

[ACP by Using the Data Browser in ODSM](#) on page 29-21 and ["Setting or Modifying Entry-Level Access by Using the Data Browser in ODSM"](#) on page 29-21.

Managing Entries by Using LDAP Command-Line Tools

This section contains the following topics:

- [Listing All the Attributes in the Directory by Using ldapsearch](#)
- [Listing Operational Attributes by Using ldapsearch](#)
- [Attribute Case in ldapsearch Output](#)
- [Adding a User Entry by Using ldapadd](#)
- [Modifying a User Entry by Using ldapmodify](#)
- [Adding an Attribute Option by Using ldapmodify](#)
- [Deleting an Attribute Option by Using ldapmodify](#)
- [Searching for Entries with Attribute Options by Using ldapsearch](#)

Listing All the Attributes in the Directory by Using ldapsearch

Use the following command line to list of all the attributes, including those that do not have values:

```
ldapsearch -p port -h host -D "cn=orcladmin" -q -b "cn=subschemasubentry" \
-s base "objectclass=*
```

Listing Operational Attributes by Using ldapsearch

By default, `ldapsearch` does not return operational attributes. If you add the character "+" to the list of attributes in the search request, however, `ldapsearch` returns all operational attributes.

Searching for an entry with "+" returns only operational attributes. For example:

```
$ ldapsearch -h adc2190517 -p 3060 -D cn=orcladmin -w welcome -b "c=uk" -L -s base
"(objectclass=*)" +
dn: c=UK
orclguid: 8EB5730F5852DECBE040E80A7452694E
creatorsname: cn=orcladmin
createtimestamp: 20100826065339z
modifytimestamp: 20100826065339z
modifiersname: cn=orcladmin
orclnormdn: c=uk
```

By comparison, a search with "*" but not "+" returns all user attributes:

```
$ ldapsearch -h adc2190517 -p 3060 -D cn=orcladmin -w welcome -b "c=uk" -L -s base
"(objectclass=*)"
dn: c=UK
c: uk
objectclass: top
objectclass: country
```

Attribute Case in Ldapsearch Output

In the output from the `ldapsearch` command, the attribute names are shown in lower case if the attribute `orclReqattrCase` in the instance-specific configuration entry is 0. If `orclReqattrCase` is set to 1, the attribute names in the output are shown in the same case in which they were entered on the command line.

Example:

```
ldapsearch -h localhost -p 389 -b "dc=oracle,dc=com" -s base -L "objectclass=*" DC
```

If `orclReqattrCase` is 0 the output looks like this:

```
dn: dc=oracle,dc=com
dc: oracle
```

If `orclReqattrCase` is 1, the output looks like this:

```
dn: dc=oracle,dc=com
DC: oracle
```

If an attribute is specified more than once on the same command line, the attribute names in the output will match the case of the first attribute specification.

Adding a User Entry by Using Ldapadd

The following example shows how to add an entry for an employee named John.

Use `ldapadd` as follows:

```
ldapadd -p port_number -h host -D cn=orcladmin -q -f entry.ldif
```

where `entry.ldif` looks like this:

```
dn: cn=john, c=us
objectclass: top
objectclass: person
objectclass: organizationalPerson
objectclass: inetOrgPerson
cn: john
cn;lang-fr:Jean
cn;lang-en-us:John
sn: Doe
jpegPhoto: /photo/john.jpg
userpassword: password
```

This file contains the `cn`, `sn`, `jpegPhoto`, and `userpassword` attributes.

For the `cn` attribute, it specifies two options: `cn;lang-fr`, and `cn;lang-en-us`. These options return the common name in either French or American English.

For the `jpegPhoto` attribute, it specifies the path and file name of the corresponding JPEG image you want to include as an entry attribute.

Notes:

- When you add or modify an entry, the Oracle directory server does not verify the syntax of the attribute values in the entry.
 - Do not insert a tilde (~) in a user name.
-
-

Modifying a User Entry by Using `ldapmodify`

The following example changes the password for a user to a new value. As in the previous example, the data for this user entry is in the `entry.ldif` file. This file contains the following:

```
dn: cn=audrey,c=us
changetype: modify
replace: userpassword
userpassword: password
```

Substitute the new password for `password` in the file.

Issue this command to modify the file:

```
ldapmodify -p 3060 -D "cn=orcladmin" -q -v -f entry.ldif
```

where `-v` specifies verbose mode.

Note: When you add or modify an entry, the Oracle directory server does not verify the syntax of the attribute values in the entry.

Adding an Attribute Option by Using `ldapmodify`

The following entry adds the Spanish equivalent of an entry for John. The data for this user entry is in the `entry.ldif` file. This file contains the following:

```
dn: cn=john,c=us
changetype: modify
add: cn;lang-sp
cn;lang-sp: Juan
```

Issue this command to modify the file:

```
ldapmodify -D "cn=orcladmin" -q -p 3060 -v -f entry.ldif
```

Deleting an Attribute Option by Using `ldapmodify`

The following example deletes the `cn;lang-fr` attribute option from the entry for John. As in the previous example, assume that the data for this user entry is in the `entry.ldif` file. This file contains the following:

```
dn: cn=john, c=us
changetype: modify
delete: cn;lang-fr
cn;lang-fr: Jean
```

Issue this command to modify the file:

```
ldapmodify -D "cn=orcladmin" -q -p 3060 -v -f entry.ldif
```

Searching for Entries with Attribute Options by Using `ldapsearch`

The following example retrieves entries with common name (`cn`) attributes that have an option specifying a language code attribute option. This particular example retrieves entries in which the common names are in French and begin with the letter R.

```
ldapsearch -D "cn=orcladmin" -q -p 3060 -h myhost -b "c=US" -s sub "cn;lang-fr=R"
```

Suppose that, in the entry for John, no value is set for the `cn;lang-it` language code attribute option. In this case, the following example fails:

```
ldapsearch -D "cn=orcladmin" -q -p 3060 -h myhost -b "c=us" \  
-s sub "cn;lang-it=Giovanni"
```

See Also: ["Attribute Options"](#) on page 3-11

You can use the `-X` or `-B` options to `ldapsearch` to print binary values.

See Also: The `ldapsearch` command reference in *Oracle Fusion Middleware Reference for Oracle Identity Management*.

Managing Dynamic and Static Groups

This chapter explains how to administer both static and dynamic groups in Oracle Internet Directory. This chapter contains these topics:

- [Introduction to Managing Dynamic and Static Groups](#)
- [Managing Group Entries by Using Oracle Directory Services Manager](#)
- [Managing Group Entries by Using the Command Line](#)

Introduction to Managing Dynamic and Static Groups

Oracle Internet Directory enables you to assign and manage membership in two types of groups—namely, static groups and dynamic groups. Each type of group suited for a different purpose.

Note: If you are creating a hierarchy of groups, be sure that it is a true hierarchy as described in "[Hierarchies](#)" on page 14-6.

See Also:

- "[Security Groups](#)" on page 29-4 for instructions on setting access control policies for group entries
- [Globalization Support](#) on page 3-15 and [Chapter 29, "Managing Directory Access Control"](#) for information about access privileges

This section contains these topics:

- [Static Groups](#)
- [Dynamic Groups](#)
- [Hierarchies](#)
- [Querying Group Entries](#)
- [orclMemberOf Attribute](#)
- [When to Use Each Kind of Group](#)

Static Groups

A static group is one whose entry contains a list of members that you explicitly administer.

A static group requires you to explicitly administer its membership. For example, if a member changes his name, then you must change that user's DN for each group he belongs to. For this reason, a static group is best suited for a group whose membership is unlikely to change frequently.

Schema Elements for Creating Static Groups

When you create the entry for this kind of group, you associate it with either the `groupOfNames` or `groupOfUniqueNames` object class.

Each of these object classes has a multivalued attribute for storing the names of group members. To assign a user as a member of a group, you add the DN of each member to the respective multivalued attribute. Conversely, to remove a member from a group, you delete the member's DN from the respective attribute. In the `groupOfNames` object class, this multivalued attribute is `member`, and, in the `groupOfUniqueNames` object class, it is `uniqueMember`.

Dynamic Groups

A dynamic group is one whose membership, rather than being maintained in a list, is computed, based on rules and assertions you specify. Oracle Internet Directory supports the following methods for dynamically computing the membership of the group:

- Using `orclDynamicGroup` object class and `labeleduri` attribute
- Using `orclDynamicGroup` object class and `CONNECT_BY` attributes
- Using `orclDynamicList` object class and `labeleduri` attribute (referred as dynamic list)

Dynamic groups can have static and dynamic members. The static members are listed as values of the `member` or `uniqueMember` attribute.

Cached and Uncached Dynamic Groups

Dynamic groups can be cached or uncached. By cached, we mean that dynamic group members are computed and stored when the dynamic group is added, and that the member list is kept consistent when the dynamic group is later modified. As entries are added, modified, deleted, and renamed, the member lists of all dynamic groups are kept consistent. For example, if there is a dynamic group containing all `person` entries under "`c=us`", when we add "`cn=user1,c=us`", that entry is automatically added to the member list of the dynamic group. Similarly, when we delete "`cn=user1,c=us`", the entry is removed from the dynamic group's member list. This feature ensures that whenever a search is performed for a dynamic group, the member list can be fetched from the stored data without any additional computation. The search performance for cached dynamic groups is almost the same as for static groups.

Cached Dynamic Group

Starting with Oracle Internet Directory 10g (10.1.4.0.1), dynamic groups based on `orclDynamicGroup` object class using `labeleduri` attribute are cached

Uncached Dynamic Group

- Dynamic groups based on `orclDynamicGroup` object class using `CONNECT_BY` attributes are not cached.
- As of Oracle Internet Directory 11g Release 1 (11.1.1.4), a second type of dynamic group based on `labeleduri` attribute is available. It is referred to as a dynamic

list, and its members are not cached. You determine whether a dynamic group based on the `labeleduri` attribute is cached or uncached by selecting the type of auxiliary object class your group is associated with, as described in "[Schema Elements for Creating a Dynamic Group](#)" on page 14-4. If you want a cached group, associate your group with the auxiliary object class `orclDynamicGroup`. If you want an uncached group, associate your group with the auxiliary object class or `orclDynamicList` object class.

Notes:

- You cannot add a dynamic group based on the `labeledURI` attribute with scope `base`. Only scope `sub` and `one` are supported.
 - To refresh dynamic group memberships for dynamic groups using the `orclDynamicGroup` object class and `labeleduri` attribute, set the attribute `orclrefreshdgrmems` in the DSA Configuration entry to 1. Oracle Internet Directory recomputes the member lists for all dynamic groups and resets the value of `orclrefreshdgrmems` to 0. If there are many groups, this operation can take a long time to complete.
 - When you query for the groups that a user belongs to, dynamic groups based on the `labeledURI` attribute are automatically included in the result. Dynamic groups based on the `CONNECT_BY` assertion and dynamic lists must be explicitly queried. For example, assume `nc=jdoe, cn=users, o=oracle` is a member of three groups: `labeleduri dynamic group dgrouplab1`, `CONNECT_BY dynamic group dgroupcby1`, and dynamic list `dlist1`. The search `uniquemember=cn=jdoe, cn=users, o=oracle` finds only the cached `labeleduri dynamic group dgrouplab1`.
-
-

See Also:

- "About LDAP Controls" in *Oracle Fusion Middleware Reference for Oracle Identity Management* for more information on controls used by Oracle Internet Directory
- The C API chapter in *Oracle Fusion Middleware Application Developer's Guide for Oracle Identity Management*
- Performing Hierarchical Searches in *Oracle Fusion Middleware Application Developer's Guide for Oracle Identity Management*

Enhancements to and Limitations of Dynamic Groups in Oracle Internet Directory

In Oracle Internet Directory 10g (10.1.4.1) and later releases, you can use dynamic groups in the same ways you use static groups. For example, you can use them in:

- Access control lists, by associating the group with either the `orclACPgroup` or the `orclPrivilegeGroup` object class.
- Hierarchical group resolution queries

Dynamic groups have the following limitations in Oracle Internet Directory:

- Hierarchical queries and queries involving specific attributes of members can only be done on cached dynamic groups.

- Dynamic groups can only be added using `ldapadd` or `ODSM`. They cannot be added by using `bulkload`.
- The attributes used in the LDAP filter part of the `labeleduri` must be indexed. See ["Creating and Dropping Indexes from Existing Attributes by Using catalog"](#) on page 15-11 and ["About Indexing Attributes"](#) on page 20-6.
- You cannot change the objectclass of a dynamic group after the group has been created. You must delete the group and re-create it.
- Searches for the `uniquemember` attribute will not pick up dynamic lists or `CONNECT BY` assertion-based dynamic groups.

Schema Elements for Creating a Dynamic Group

When you create a dynamic group, you begin as when creating a static group—that is, you associate its entry with either the `groupOfNames` or `groupOfUniqueNames` object class. You then associate that object class with the auxiliary object class `orclDynamicGroup` or `orclDynamicList`.

The auxiliary object class `orclDynamicGroup` has various attributes in which you specify one of two methods for dynamically computing the membership of the group: using the `labeledURI` attribute and using a `CONNECT BY` assertion. The auxiliary object class `orclDynamicList` supports only the `labeledURI` attribute method of computing membership.

The two methods of computing membership are:

- Using the `labeledURI` attribute

Both of the auxiliary object classes `orclDynamicGroup` and `orclDynamicList` have the `labeledURI` attribute. If you associate your group with `orclDynamicGroup` and use the `labeledURI` attribute to compute membership, the group is cached. If you associate your group with `orclDynamicList` and use the `labeledURI` attribute to compute membership, the group is not cached. This uncached type, using `orclDynamicList` objectclass, is referred to as a dynamic list.

When using the `labeledURI` method, the directory server performs a typical search based on the hierarchy of the DIT. It requires you to provide a value for one of the attributes of the `orclDynamicGroup` or `orclDynamicList` object class, namely `labeledURI`. In this attribute, you specify the base of the query, the filters, and any required attributes. For example, suppose that you have entered the following value for the `labeledURI` attribute:

```
labeledURI:ldap://host:port/ou=NewUnit,o=MyCompany,c=US??sub?(objectclass=person)
```

When you use this method, a search for the entry returns entries for all members of the group.

Do not set `orclConnectByAttribute` or `orclConnectByStartingValue` when using the `labeledURI` attribute method.

Note: In the `labeledURI` attribute, the `host:port` section is present for syntax purposes alone. Irrespective of the host and port settings in the `labeledURI` attribute, the directory server always computes members of dynamic group from the local directory server. It cannot retrieve members from other directory servers.

See Also: "The LDAP URL Format" (RFC 2255). T. Howes, M. Smith, December 1997. This RFC provides more information about how LDAP URLs are to be represented—as, for example, in the `labeledURI` attribute. It is available at <http://www.ietf.org>.

- Using a `CONNECT BY` assertion

Unlike the `labeledURI` attribute method, this method relies not on the hierarchy of the DIT, but on attributes that implicitly connect entries to each other, regardless of their location in the DIT. For example, the `manager` attribute connects the entries of employees with those of their managers, and this connection applies regardless of the location of the employee entries in the DIT. This method uses a `CONNECT BY` clause in which you specify the attribute to use for building the hierarchy—for example, `manager`—and the starting value for such a hierarchy—for example, `cn=Anne Smith, cn=users, dc=example, dc=com`.

See Also: *Performing Hierarchical Searches in Oracle Fusion Middleware Application Developer's Guide for Oracle Identity Management*

More specifically, to use this method, you specify in the `orclDynamicGroup` object class a value for each of the single-valued attributes in [Table 14-1](#).

Table 14-1 *orclDynamicGroup Attributes for "Connect By" Assertions*

Attribute	Description
<code>orclConnectByAttribute</code>	The attribute that you want to use as the filter for the query—for example, <code>manager</code> . This attribute must be indexed.
<code>orclConnectByStartingValue</code>	The DN of the attribute you specified in the <code>orclConnectByAttribute</code> attribute—for example, <code>cn=Anne Smith, cn=users, dc=example, dc=com</code>

For example, to retrieve the entries of all employees who report to Anne Smith in the `MyOrganizationalUnit` in the Americas, you would provide values for these attributes as follows:

```
orclConnectByAttribute=manager
orclConnectByStartingValue=
"cn=Anne Smith,ou=MyOrganizationalUnit,o=MyCompany,c=US"
```

Do not set `labeledURI` when using the `CONNECT BY` assertion method.

You can also develop an application specifying that you want the values for a particular attribute—for example, the `email` attribute—of all the members.

See Also: *Oracle Fusion Middleware Application Developer's Guide for Oracle Identity Management* for more information about how to develop applications that retrieve values for particular attributes

The following examples show the two kinds of dynamic group entries.

Example: a Dynamic Group Entry Using the `labeledURI` Attribute

The following is an example of a dynamic group entry using the `labeledURI` attribute.

```
dn: cn=dgroup1
cn: dgroup1
```

```
description: this is an example of a dynamic group
labeleduri:ldap://hostname:7777/ou=oid,l=amer,dc=oracle,
  dc=dgrptest??sub?objectclass=person
objectclass: orcdynamicgroup
objectclass: groupOfUniqueNames
objectclass: top
```

This group will have `uniquemember` values that are the DNs of all entries associated with the object class `person` in the subtree `ou=oid,l=amer,dc=oracle,dc=dgrptest`.

Example: a Dynamic List Entry Using the `labeledURI` Attribute

The following is an example of a dynamic list entry using the `labeledURI` attribute. (Dynamic lists are not cached.) It is the same as the previous example, except that the auxiliary object class is `orcdynamiclist` instead of `orcdynamicgroup`

```
dn: cn=dgroup1
cn: dgroup1
description: this is an example of a dynamic group
labeleduri:ldap://hostname:7777/ou=oid,l=amer,dc=oracle,
  dc=dgrptest??sub?objectclass=person
objectclass: orcdynamiclist
objectclass: groupOfUniqueNames
objectclass: top
```

This group will have `uniquemember` values that are the DNs of all entries associated with the object class `person` in the subtree `ou=oid,l=amer,dc=oracle,dc=dgrptest`. Searches for the `uniquemember` attribute, however, will not pick up dynamic lists

Example: a Dynamic Group Entry Using the `CONNECT BY` Assertion

The following is an example of a dynamic group entry that uses the `CONNECT_BY` assertion.

```
dn: cn=dgroup2
cn: dgroup2
description: this is connect by manager assertion dynamic group
orlconnectbyattribute: manager
orlconnectbystartingvalue: cn=john doe sr,l=amer,dc=oracle,dc=dgrptest
objectclass: orcdynamicgroup
objectclass: groupOfUniqueNames
objectclass: top
```

This dynamic group has unique members with values that are DNs of all the entries whose `manager` attribute is `cn=john doe sr`. either indirectly or directly. If several individuals have `cn=john doe JR`. as their manager, and he, in turn, has `cn=john doe SR`. as his manager, then all the lower-level individuals are returned.

Hierarchies

Hierarchies can be either explicit or implicit.

In explicit hierarchies, the relationship is determined by the location of the entry in the DIT—for example, Group A may reside higher in the DIT than Group B.

In implicit hierarchies, the relationship between entries is determined not by the location in the DIT, but by the values of certain attributes. For example, suppose that you have a DIT in which the entry for John Doe is at the same level of the hierarchy as Anne Smith. However, suppose that, in the entry for John Doe, the `manager` attribute

specifies Anne Smith as his manager. In this case, although their locations in the DIT are at an equal level, their rankings in the hierarchy are unequal because Anne Smith is specified as John Doe's manager.

Note: In a query based on an implicit hierarchy, the client can specify in the search request the control 2.16.840.1.113894.1.8.3. The filter in this query specifies the attribute used to build the implicit hierarchy. For example, `(manager=cn=john doe, o=foo)` specifies the query for all people reporting directly or indirectly to John Doe. The implicit hierarchy is based on the `manager` attribute. The base of the search is ignored for such queries.

For more information on controls used by Oracle Internet Directory, see "About LDAP Controls" in *Oracle Fusion Middleware Reference for Oracle Identity Management*.

See Also: The C API chapter in *Oracle Fusion Middleware Application Developer's Guide for Oracle Identity Management*

Querying Group Entries

An application can query either kind of group to do the following:

- List all members of a group
- List all groups of which a user is a member
- Check to see if a user is a member of a particular group

In addition, you can query dynamic groups, but not static ones, for whatever member attributes you specify.

See Also: The `GSL_REQDATTR_CONTROL` entry under "LDAP Controls" in *Oracle Fusion Middleware Reference for Oracle Identity Management*.

orclMemberOf Attribute

`orclMemberOf` is a multivalued attribute containing the groups to which the entry belongs. The groups in `orclMemberOf` include static groups and `labeleduri`-based dynamic groups. `CONNECT BY` assertion-based dynamic groups and dynamic lists are not included. The membership includes both direct groups and nested groups.

For example, suppose Mary is a member of the static group `directors` and the group `directors` is a member of the static group `managers`. If you do a specific query for the attribute `orclMemberOf` on Mary's DN, it will show the value:

```
managers, directors
```

The attribute values are computed during search and are not stored. This attribute cannot be used in search filters. `orclMemberOf` is not returned in a search unless explicitly requested by name.

`orclMemberOf` has the aliases `memberof` and `ismemberof` for compatibility with Active Directory and Oracle Directory Server Enterprise Edition (formerly Sun Java System Directory Server and SunONE iPlanet).

See Also: [Chapter 17, "Managing Alias Entries."](#)

When to Use Each Kind of Group

When deliberating about which kind of group to use, you must weigh the ease of administration against higher performance. For example, dynamic groups provide for easier administration, but cause a decrease in performance. [Table 14–2](#) lists some things to consider when deliberating whether to use static or dynamic groups.

Table 14–2 Static and Dynamic Group Considerations

Consideration	Static Groups	Dynamic Groups
Ease of administration	More difficult to administer if group memberships are large and change frequently	Easier to use, especially when group memberships are large and change frequently
Search Performance	Higher level of performance because you explicitly administer the membership list	Slightly decreased level of performance with dynamic groups using <code>labeleduri</code> , but almost same when compared to static groups, because memberships are cached. Decrease in performance with uncached groups, when compared to static groups and cached dynamic groups because memberships are computed as needed.

Managing Group Entries by Using Oracle Directory Services Manager

You can manage static and dynamic group entries by using the Data Browser page in Oracle Directory Services Manager. You can display group entries, search for groups, and view groups using the procedures described in "[Managing Entries by Using Oracle Directory Services Manager](#)" on page 13-1. The procedures for creating and modifying groups are described in this section. This section contains the following topics:

- [Creating Static Group Entries by Using Oracle Directory Services Manager](#)
- [Modifying a Static Group Entry by Using Oracle Directory Services Manager](#)
- [Creating Dynamic Group Entries by Using Oracle Directory Services Manager](#)
- [Modifying a Dynamic Group Entry by Using Oracle Directory Services Manager](#)

Creating Static Group Entries by Using Oracle Directory Services Manager

If the static group entry belongs to the `groupOfNames` object class, then you determine membership in the group by adding DNs to the multivalued attribute `member`. If the entry belongs to the `groupOfUniqueNames` object class, then you determine membership in the group by adding DNs to the multivalued attribute `uniqueMember`.

To add a static group entry:

1. Invoke Oracle Directory Services Manager and connect to the Oracle Internet Directory server as described in ["Invoking Oracle Directory Services Manager"](#) on page 7-9.
2. From the task selection bar, select **Data Browser**.
3. On the toolbar, choose the **Create a new entry** icon. Alternatively, right click any entry and choose **Create**.

You can, alternatively, select a group that is similar to the one you want to create, then choose the **Create a new entry like this one** icon. Alternatively, right click any entry and choose **Create**.

The Create New Entry wizard appears.
4. Specify the object classes for the new entry. Click the **Add** icon and use the Add Object Class dialog to select either `groupOfNames` or `groupOfUniqueNames`. (All the superclasses from this object class through `top` are also added.)

Click **OK**.
5. In the **Parent of the entry** field, you can specify the full DN of the parent entry of the entry you are creating. You can also click **Browse** to locate and select the DN of the parent for the entry you want to add, then click **Select**.

If you leave the **Parent of the entry** field blank, the entry is created under the root entry.
6. Click **Next**.
7. Choose an attribute which will be the **Relative Distinguished Name** value for this entry and enter a value for that attribute. You must enter a value for the `cn` attribute, even if it is not the RDN value.
8. Click **Next**. The next page of the wizard appears. (Alternatively, you can click **Back** to return to the previous page.)
9. Click **Finish**.
10. To add an owner or member, navigate to the group entry you just created in the Data Tree.
11. Select the **Group** tab.
12. To add an owner to the group, click the **Add** icon next to the Owner box.
13. Enter the owner's DN or click the button to select the entry you want to add as owner (usually a user or group entry) in the Select Distinguished Name Path dialog.

Click **OK**.
14. To add a member to the group, click the Add icon next to the Members text box
15. Enter the member's DN or click the button to select the entry you want to add as a member (usually a user or group entry) in the Select Distinguished Name Path dialog.

Click **OK**.
16. Optionally, enter a description for the entry.
17. Choose **Apply** to apply your changes or choose **Revert** to abandon your changes.
18. To make other changes to the group entry, see ["Modifying a Static Group Entry by Using Oracle Directory Services Manager"](#)

See Also:

- ["Dynamic Groups"](#) on page 14-2
- ["Security Groups"](#) on page 29-4
- ["Globalization Support"](#) on page 3-15

Modifying a Static Group Entry by Using Oracle Directory Services Manager

To modify an attribute, such as the member list, for a group entry:

1. Select the group in the data tree.
2. To add or delete an owner or member, select the **Group** tab or the **Attributes** tab.
3. To add a member to the group, click the Add icon next to the Members text box.
4. Select the entry you want to add as a member (usually a user or group entry) in the Select Distinguished Name Path dialog.
Click **OK**.
5. To add an owner to the group, click the Add icon next to the Owners text box.
6. Select the entry you want to add as an owner (usually a user or group entry) in the Select Distinguished Name Path dialog
Click **OK**.
7. To delete an owner or member, select it in the list and click the **Delete** icon.
8. To add or modify an attribute other than an owner or member, select the **Attributes** tab.
9. By default, only non-empty attributes are shown. You can switch between **Managed Attributes** and **Show All** by using the **Views** list.
10. To change the list of attributes shown as managed attributes, click the icon under **Optional Attributes**. Select attributes you want to move from the All Attributes list to the Shown Attributes lists and use the **Move** and **Move All** arrows to move the attributes. Select attributes you want to move from the shown Attributes list to the All Attributes lists and use the **Remove** and **Remove All** arrows to move the attributes. Click **Add Attributes** to make your changes take effect or click **Cancel** to discard your changes. After you click **Add Attributes**, only the attributes that were on the Shown Attributes list are shown in the Managed Attributes view.
11. Specify values for the optional properties. You can also modify the values of the mandatory properties. For multivalued attributes, you can use the **Add** and **Delete** icons to add and delete multiple values.
12. Click **Apply** to save your changes or **Revert** to discard them.
13. You can set an access control point (ACP) on this entry by using the Subtree Access and Local Access tabs. The procedures are described in ["Adding or Modifying an ACP by Using the Data Browser in ODSM"](#) on page 29-21 and ["Setting or Modifying Entry-Level Access by Using the Data Browser in ODSM"](#) on page 29-21.

Creating Dynamic Group Entries by Using Oracle Directory Services Manager

Dynamic groups can have static and dynamic members. The static members are listed as values of the member or `uniquemember` attribute. If the dynamic group entry belongs to the `groupOfNames` object class, then add static members to the group by

adding DN's to the multivalued attribute `member`. If the dynamic group entry belongs to the `groupOfUniqueNames` object class, then add static members to the group by adding DN's to the multivalued attribute `uniqueMember`.

For dynamic groups, you must also set attributes to specify how the group membership is computed. You must choose either the `labeledURI` or the `CONNECT BY` method for dynamically computing membership in the group. You cannot use both methods. If you are using the `labeledURI` method, you must set the `labeledURI` attribute, but not the `orclConnectByAttribute` and `orclConnectByStartingValue` attributes. If you are using the `CONNECT BY` method, you must set the `orclConnectByAttribute` and `orclConnectByStartingValue` attributes, but not the `labeledURI` attribute.

To add a dynamic group entry:

1. Invoke Oracle Directory Services Manager and connect to the Oracle Internet Directory server as described in "[Invoking Oracle Directory Services Manager](#)" on page 7-9.
2. From the task selection bar, select **Data Browser**.
3. On the toolbar, choose **Create a new entry**. The Create New Entry wizard appears.
4. Specify the object classes for the new entry. Select at least the following object class entries.
 - Either `groupOfNames` or `groupOfUniqueNames`
 - `orclDynamicGroup` or `orclDynamicList`

Use `orclDynamicGroup` for a cached dynamic group based on `labeledURI` or a dynamic group based on `CONNECT BY`. Use `orclDynamicList` for an uncached dynamic list based on `labeledURI`.

Click the **Add** icon and use the Add Object Class dialog to select object class entries. Optionally, use the search box to filter the list of object classes. To add the object class, select it and then click **OK**. (All the superclasses from this object class through `top` are also added.)

5. In the **Parent of the entry** field, you can specify the full DN of the parent entry of the entry you are creating. You can also click **Browse** to locate the DN of the parent for the entry you want to add, then click **Select**.

If you leave the **Parent of the entry** field blank, the entry is created under the root entry.

6. Click **Next**.
7. Choose an attribute which will be the **Relative Distinguished Name** value for this entry and enter a value for that attribute. You must enter a value for the `cn` attribute, even if it is not the RDN value.
8. Click **Next**. The next page of the wizard appears. (Alternatively, you can click **Back** to return to the previous page.)
9. Click **Finish**.
10. To add an owner or member, navigate to the group entry you just created in the Data Tree. (You might have to click the Refresh icon to see the new entry).
11. Select the **Group** tab.
12. To add an owner to the group, click the **Add** icon next to the Owner box.

13. Select the entry you want to add as owner (usually a user or group entry) in the Select Distinguished Name Path dialog.
Click **OK**.
14. To add a member to the group, click the Add icon next to the Members text box
15. Select the entry you want to add as a member (usually a user or group entry) in the Select Distinguished Name Path dialog.
Click **OK**.
16. Optionally, enter a description for the entry.
17. Choose **Apply** to apply your changes or choose **Revert** to abandon your changes.
18. Select the **Attributes** tab.
19. You can switch between Managed Attributes and Show All by using the **Views** list.
20. To change the list of attributes shown as managed attributes, click the icon under **Optional Attributes**. Select attributes you want to move from the All Attributes list to the Shown Attributes lists and use the **Move** and **Move All** arrows to move the attributes. Select attributes you want to move from the shown Attributes list to the All Attributes lists and use the **Remove** and **Remove All** arrows to move the attributes. Click **Add Attributes** to make your changes take effect or click **Cancel** to discard your changes. After you click **Add Attributes**, only the attributes that were on the Shown Attributes list are shown in the Managed Attributes view.
21. If you are using the `labeledURI` method for dynamically computing membership in the group, you must set the `labeledURI` attribute, but not the `orclConnectByAttribute` and `orclConnectByStartingValue` attributes. In the **Attributes** tab page, in the `labeledURI` field, specify the following:

```
ldap:ldap_URL
```

For example:

```
ldap://my_host:3000/ou=MyNeworganizationalUnit,  
o=MyCompany,c=US??sub?(objectclass=person)
```

If you are using the `CONNECT BY` method for dynamically computing membership in the group, you must set the `orclConnectByAttribute` and `orclConnectByStartingValue` attributes, but not the `labeledURI` attribute. In the `orclConnectByAttribute` field, specify the attribute that you want to use as the filter for the query—for example, `manager`. In the `orclConnectByStartingValue` field, specify the DN of the attribute you specified in the `orclConnectByAttribute` attribute—for example, `cn=Anne Smith`.

For information about specifying the other attributes that appear in the **Attributes** tab page, see "User and Group Schema Elements" in *Oracle Fusion Middleware Reference for Oracle Identity Management*.

22. Click **Apply** to save your changes or **Revert** to discard them.
23. You can set an access control point (ACP) on this entry by using the Subtree Access and Local Access tabs. The procedures are described in "[Adding or Modifying an ACP by Using the Data Browser in ODSM](#)" on page 29-21 and "[Setting or Modifying Entry-Level Access by Using the Data Browser in ODSM](#)" on page 29-21.

See Also:

- ["Dynamic Groups"](#) on page 14-2
- ["Security Groups"](#) on page 29-4
- ["Globalization Support"](#) on page 3-15

Modifying a Dynamic Group Entry by Using Oracle Directory Services Manager

Remember that you must choose either the `labeledURI` or the `CONNECT BY` method for dynamically computing membership in the group. You cannot use both methods. If you are using the `labeledURI` method, you must set the `labeledURI` attribute, but not the `orclConnectByAttribute` and `orclConnectByStartingValue` attributes. If you are using the `CONNECT BY` method, you must set the `orclConnectByAttribute` and `orclConnectByStartingValue` attributes, but not the `labeledURI` attribute.

To modify an attribute for a dynamic group entry, proceed as for a static group entry, as described in ["Modifying a Static Group Entry by Using Oracle Directory Services Manager"](#) on page 14-10. You can add static members to a dynamic group, but you are not required to do so.

Managing Group Entries by Using the Command Line

You can manage static and dynamic groups from the command line by using LDAP tools. This section contains the following topics:

- [Creating a Static Group Entry by Using `ldapadd`](#)
- [Modifying a Static Group by Using `ldapmodify`](#)
- [Creating a Dynamic Group Entry by Using `ldapadd`](#)
- [Modifying a Dynamic Group by Using `ldapmodify`](#)

Notes:

- When you create a group, specifying members is optional and is shown here for the sake of completeness.
 - It is uncommon to have dynamic groups with static membership.
-
-

Creating a Static Group Entry by Using `ldapadd`

The syntax for the LDIF file is:

```
dn: DN_of_group_entry
objectclass: top
objectclass: groupOfNames | groupOfUniqueNames
member: DN of member 1
member: DN of member 2
.
.
.
member: DN of member N
```

The following command adds the group and members in this LDIF file to the directory:

```
ldapadd -p port_number -h host -D cn=orcladmin -q -f file_name.ldif
```

Example: Creating a Static Group Entry by Using Idapadd The following example shows an LDIF file named `myStaticGroup.ldif` for the entry for a group named `MyStaticGroup`:

```
dn: cn=myStaticGroup,c=us
objectclass: top
objectclass: groupOfNames
member: cn=John Doe
member: cn=Anne Smith
```

The following command adds the group and members in this LDIF file to the directory:

```
ldapadd -p 3060 -h myhost -D cn=orcladmin -q -f myStaticGroup.ldif
```

Modifying a Static Group by Using Idapmodify

To add a member to a group, the syntax of the LDIF file is:

```
dn: DN_of_group_entry
changetype: modify
add: member
member: DN of member entry
```

To delete a member from a group, the syntax of the LDIF file is:

```
dn: DN of group entry
changetype: modify
delete:member
member:DN of member entry
```

Issue this command to modify the file:

```
ldapmodify -D "cn=orcladmin" -q -p 3060 -v -f file_name.ldif
```

where `-v` specifies verbose mode.

Example: Modifying a Static Group by Using Idapmodify The following example adds John Doe to a group named `MyStaticGroup`. As in the previous example, the data for this user entry is in the `myStaticGroup.ldif` file. This file contains the following:

```
dn: cn=myStaticGroup,c=us
changetype: modify
add:member
member: cn=John Doe
```

Issue this command to modify the file:

```
ldapmodify -D "cn=orcladmin" -q -p 3060 -v -f myStaticGroup.ldif
```

where `-v` specifies verbose mode.

Note: When you add or modify an entry, the Oracle directory server does not verify the existence of the entry. However, if the attribute value must contain a DN, then the directory server verifies that the DN is specified.

Creating a Dynamic Group Entry by Using ldapadd

You can use `ldapadd` to create a dynamic group from the command line.

Creating a Cached Dynamic Group Using labeledURI Attribute

If you use the `labeledURI` attribute to create a cached dynamic group, then the syntax for the LDIF file is:

```
dn: DN_of_group_entry
objectclass: top
objectclass: groupOfNames | groupOfUniqueNames
objectclass: orcldynamicgroup
labeledURI:ldap:ldap_URL
member: DN of member 1
member: DN of member 2
.
.
member: DN of member N
```

Use the following command to add the group and members in this LDIF file to the directory:

```
ldapadd -p port_number -h host -f file_name.ldif
```

Creating an Uncached Dynamic List Using labeledURI Attribute

If you use the `labeledURI` attribute to create an uncached dynamic list, then the syntax for the LDIF file is:

```
dn: DN_of_group_entry
objectclass: top
objectclass: groupOfNames | groupOfUniqueNames
objectclass: orcldynamiclist
labeledURI:ldap:ldap_URL
member: DN of member 1
member: DN of member 2
.
.
member: DN of member N
```

Use the same command as in the previous example to add the group and members in this LDIF file to the directory:

```
ldapadd -p port_number -h host -f file_name.ldif
```

Creating a Dynamic Group Using CONNECT BY String

If you use the `CONNECT BY` string, then the syntax for the LDIF file is:

```
dn: DN_of_group_entry
objectclass: top
objectclass: groupOfNames | groupOfUniqueNames
objectclass: orclDynamicGroup
orclConnectByAttribute:attribute_name
orclConnectByStartingValue:DN_of_attribute
member: DN of member 1
member: DN of member 2
.
```

```
.  
.br/>member: DN of member N
```

When specifying entries in this syntax, do not use double quotes around distinguished names.

The following example shows an LDIF file for the entry for a dynamic group:

```
dn: cn=myDynamicGroup,c=us  
objectclass: top  
objectclass: groupOfNames  
objectclass: orcldynamicgroup  
labeledURI:ldap://my_host:3000/ou=MyNeworganizationalUnit,  
o=MyCompany,c=US??sub?(objectclass=person)  
member: cn=John Doe  
member: cn=Anne Smith
```

The following command adds this LDIF file to the directory:

```
ldapadd -p 3060 -h myhost -f myDynamicGroup.ldif
```

Modifying a Dynamic Group by Using Idapmodify

To change the organizational unit of the group created in the previous example, the syntax of the LDIF file is:

```
dn: DN_of_group_entry  
changetype: modify  
replace:labeledURI  
labeledURI:ldap://my_host:3000/  
ou=MyNeworganizationalUnit,o=MyCompany,c=US??sub?(objectclass=person)
```

Note: When you add or modify an entry, the Oracle directory server does not verify the syntax of the attribute values in the entry.

Performing Bulk Operations

This chapter consists of the following sections:

- [Introduction to Performing Bulk Operations](#)
- [Changing Server Mode](#)
- [Loading Data Into the Schema by Using bulkload](#)
- [Modifying Attributes of a Large Number of Entries By Using bulkmodify](#)
- [Deleting Entries or Attributes of Entries by Using bulkdelete](#)
- [Dumping Data from Oracle Internet Directory to a File by Using ldifwrite](#)
- [Creating and Dropping Indexes from Existing Attributes by Using catalog](#)

Introduction to Performing Bulk Operations

For processing large quantities of data, bulk operations are typically more efficient than standard LDAP operations. You can perform bulk operations only by using the command-line bulk tools.

Before you begin using the Oracle Identity Management command-line tools, you must configure your environment. This involves setting the appropriate environment variables.

The syntax and examples provided in this guide require that you have the following environment variables set:

- `ORACLE_HOME` - The location of non-writable files in your Oracle Identity Management installation.
- `ORACLE_INSTANCE` - The location of writable files in your Oracle Identity Management installation.
- `NLS_LANG` (`APPROPRIATE_LANGUAGE.AL32UTF8`) - The default language set at installation is `AMERICAN_AMERICA`.
- `WLS_HOME` - The location where the WebLogic Server is installed. This environment variable is required for Oracle Directory Integration Platform commands but not Oracle Internet Directory commands.
- `PATH` - The following directory locations should be added to your `PATH`:

`ORACLE_HOME/bin`

`ORACLE_HOME/ldap/bin`

`ORACLE_HOME/ldap/admin`

Note: The bulk tools do not support attribute uniqueness.

In addition to this chapter, bulk tools are also discussed in the following sections of this book:

- ["Indexing an Attribute for Which Data Exists by Using the Catalog Management Tool"](#) on page 20-21
- ["Introduction to Logging"](#) on page 23-1
- ["Backing Up and Restoring a Small Directory or Specific Naming Context"](#) on page 25-1
- ["Migrating Data from LDAP-Compliant Directories"](#) on page 36-1
- [Chapter 38, "Setting Up Replication"](#)

See Also: The chapter on Oracle Internet Directory administration tools in *Oracle Fusion Middleware Reference for Oracle Identity Management*.

Notes:

- Stop all instances of Oracle Internet Directory before using `bulkload`. Before using any of the other bulk tools, either stop all instances of Oracle Internet Directory or disable the entry cache.
 - Do not start Oracle Internet Directory while a bulk tool is executing.
-
-

Tip: The syntax descriptions in this chapter show true or false arguments in the following format:

```
check="TRUE"
```

You can type `true` or `false` in uppercase or lowercase, you can specify just the first letter, and you can omit the double quotes. That is, the following specifications are equivalent:

```
check=t
check=true
check="true"
check=T
check=TRUE
check="TRUE"
```

Changing Server Mode

Some bulk tool operations and replication setup procedures require you to switch an Oracle Internet Directory instance from read/write to read-only mode or from read-only to read/write mode. You can do so by using either Oracle Enterprise Manager Fusion Middleware Control or `ldapmodify`.

While the server is in read-only mode, only the administrator `cn=orcladmin` can write to the directory. As a result, you can only make changes to the directory by using utilities that enable you to connect as `cn=orcladmin`. These include:

- Oracle Directory Services Manager
- Command line tools

You cannot make changes while the server is in read-only mode by using WLST or Oracle Enterprise Manager Fusion Middleware Control because they connect to the Oracle Internet Directory server as the user `cn=emd_admin, cn=oracle_internet_directory`.

Setting the Server Mode by Using Fusion Middleware Control

To set the server mode to read-only from Fusion Middleware Control:

1. Select **Administration**, then **Server Properties** from the **Oracle Internet Directory** menu.
2. Select **General**.
3. Choose **Read-only** for Server Mode.
4. Click **Apply**.

To set the server mode to read/write mode from Fusion Middleware Control, use the same procedure but choose **Read/Write** in Step 3.

Setting the Server Mode by Using ldapmodify

To set the server mode to Read-Only by using `ldapmodify`, run the following command:

```
ldapmodify -D "cn=orcladmin" -q -h host_name \
          -p port -f change_mode.ldif
```

where the file `change_mode.ldif` has the following content:

```
dn: cn=componentname,cn=osldapd,cn=subconfigsentry
changetype: modify
replace: orclservermode
orclservermode: r
```

To set the server mode to Read/Write by using `ldapmodify`, use the same command but change the last line in the LDIF file to:

```
orclservermode: rw
```

Loading Data Into the Schema by Using bulkload

The bulk loader, `bulkload`, is a bulk management tool. It takes input data in LDIF or SQL*Loader format and loads the data directly into Oracle Internet Directory's schema in the metadata repository. It has three main phases: `check`, `generate` and `load`.

In the `check` phase, `bulkload` parses and verifies the LDIF input data for the schema.

In the `generate` phase, `bulkload` generates intermediate files in SQL*Loader format.

In the `load` phase, `bulkload` can use either of two methods: bulk mode loading or incremental mode loading.

- When using bulk mode loading, `bulkload` loads generated intermediate files into the database. As it does so, it drops old indexes and generates new ones.

- When using incremental mode loading, `bulkload` loads intermediate files to tables in the database using insert mode. While it loads the data, `bulkload` updates the indexes.

Bulk mode loading is faster than incremental mode loading.

The bulk loader also supports the following features:

- It enables you to specify the number of threads in order to achieve parallelism during the generate and load phases.
- It has an `encode` option that enables you to use data in other languages.
- It has a `restore` option that enables you to retain the operational attributes specified in the LDIF file.
- It has an `index` option for index recreation and a `missing` option for creation of missing indexes.
- It has a `recover` option that is useful for recovering from `bulkload` failures.
- When appending the data to existing directories, `bulkload` supports both bulk mode and incremental mode loading.
- The `append` option enables you to load data while the LDAP server is up and running.

At the beginning of the `generate` phase, the server's `orclServerMode`, in the instance-specific configuration entry, is changed from `read/write` to `read-modify`. At the end of the `generate` phase, it is left in the `read-modify` state so that you cannot add entries to Oracle Internet Directory between the `generate` and `load` phases. This is necessary to maintain internal sequence numbers. You are expected to run the `load` phase immediately after the `generate` phase. At the end of the `load` phase, the servers' `orclServerMode` is set back to `read/write`. Using `bulkload` with the `recover` option also sets `orclServerMode` back to `read/write`.

At the start of the load operation, `bulkload` determines the current configured value of `orclRIenabled`, then disables referential integrity. At the end of load phase, `bulkload` returns `orclRIenabled` to its original value. If any referential integrity violations occurred, however, referential integrity is disabled, and you see the message:

```
There is a violation of Referential Integrity and hence it is Disabled now. Run
the OIDDIAg tool with diagnostic option to collect the Entries which have dangling
DN attribute values and Fix the violation
Fix the violation and then set orclRIenabled to the desired value.
```

The `bulkload` tool generates the following output files in the `ORACLE_INSTANCE/diagnostics/logs/OID/tools` directory:

- An output log, `bulkload.log`
- A list of duplicate DNs, `duplicateDN.log`
- Intermediate files, `*.ctl` and `*.dat`

The `bulkload` tool generates the following output files in the `ORACLE_INSTANCE/OID/load` directory:

- A list of bad LDIF entries, `badentry.ldif`
- A list of all dynamic group entries that can be added using `ldapadd`, `dynGrp.ldif`
- Intermediate log files generated by the SQL*Loader, `bsl_*.log`

Notes:

- If a directory server instance is participating in a replication agreement, do not use the `bulkload` tool to add data into the node. Instead, use `ldapadd`.
- Before using `bulkload`, ensure that the environment variable `ORACLE_INSTANCE` has been set to the full path name of the Oracle instance.
- Running the `bulkload load` operation sets the server mode to read/write. If you require a different mode, reset it after performing the `load` operation.
- If the applicable password policy has the `pwdmustchange` attribute set to 1, then for every new entry loaded by `bulkload`, the `pwdreset` attribute is set to 1 by default. See [Chapter 28, "Managing Password Policies"](#) for more information.
- If you do not use the `bulkload` utility to populate the directory, then you must run the `oidstats.sql` tool to avoid significant search performance degradation.

See Also: The `oidstats.sql` command-line tool reference in *Oracle Fusion Middleware Reference for Oracle Identity Management* for a description and syntax for the `oidstats.sql` tool

The `bulkload` tool has the following syntax:

```
bulkload [connect=connect_string]
{[check="TRUE"|"FALSE" [file=ldif_file]] [generate="TRUE"|"FALSE"
[append="TRUE"|"FALSE"] [restore="TRUE"|"FALSE"] [thread=num_of_threads]
file=ldif_file] [load="TRUE"|"FALSE" [append="TRUE"|"FALSE"]
[thread= num_of_threads]] [index="TRUE"|"FALSE"] [missing="TRUE"|"FALSE"]
[recover="TRUE"|"FALSE"]} [encode=character_set] [debug="TRUE"|"FALSE"]
[verbose="TRUE"|"FALSE"]
```

Some of the parameter combinations are valid while others are invalid.

You must set the environment variable `ORACLE_INSTANCE`. Specify the fully qualified path to the Oracle Instance where the intermediate file is generated.

You must specify at least one of the following actions when you invoke `bulkload`: `check`, `generate`, `load`, `append`, `recover`, or `index`.

If `check` is `TRUE`, `bulkload` performs a schema check.

If `generate` is `TRUE`, `bulkload` generates intermediate files.

When using the `check` or `generate` action, you must specify the path name to the LDIF data file.

If `load` is `TRUE`, `bulkload` loads intermediate files.

When `append` is `TRUE`, `bulkload` can perform its actions while the server is up and running.

Use the `restore` flag only when the LDIF file contains operational attributes, such as `orclguid` or `creatorsname`. Avoid having operational attributes in the LDIF file when the `restore` flag is not specified or is set to `FALSE`.

Do not specify `recover` with any other option.

The option combination `check index` verifies the existing indexes.

Importing an LDIF File by Using bulkload

To import an LDIF file, you use the `bulkload` utility. This section discusses the tasks to process an LDIF file through `bulkload`.

See Also: The `bulkload` command-line tool reference in *Oracle Fusion Middleware Reference for Oracle Identity Management*.

This section contains these topics:

- [Task 1: Stopping Oracle Internet Directory Processes](#)
- [Task 2: Backing Up the Oracle Database Server](#)
- [Task 3: Finding Out the Oracle Internet Directory Password](#)
- [Task 4: Checking Input for Schema and Data Consistency Violations and Generating the Input Files for SQL*Loader](#)
- [Task 5: Loading the Input Files](#)

Task 1: Stopping Oracle Internet Directory Processes

Stop all Oracle Internet Directory server instances by using either Fusion Middleware Control or the command line.

See Also: [Chapter 8, "Managing Oracle Internet Directory Instances"](#)

Task 2: Backing Up the Oracle Database Server

Before you import the file, back up the Oracle database server as a safety precaution.

See Also: *Oracle Database Backup and Recovery Basics* in the Oracle Database Documentation Library

Task 3: Finding Out the Oracle Internet Directory Password

To use `bulkload`, you must provide the Oracle Internet Directory ODS schema password.

See Also: The `oidpasswd` command-line tool reference in *Oracle Fusion Middleware Reference for Oracle Identity Management*

Task 4: Checking Input for Schema and Data Consistency Violations and Generating the Input Files for SQL*Loader

On UNIX, the `bulkload` tool usually resides in `$ORACLE_HOME/ldap/bin`. On Microsoft Windows, this tool usually resides in `ORACLE_HOME\ldap\bin`.

Check the input file and generate files for the SQL*Loader by typing:

```
bulkload connect="connect_string" \  
  check="TRUE" generate="TRUE" file="full_path_to_ldif-file_name"
```

When you specify both the `check` and `generate` options, the entries are checked for schema compliance.

All check-related errors are reported as command line output. All schema violations are reported in `ORACLE_INSTANCE/diagnostics/logs/OID/tools/bulkload.log`. All bad entries are logged in `ORACLE_INSTANCE/OID/load/badentry.ldif`.

If there are duplicate entries, their DN's are logged in `ORACLE_INSTANCE/diagnostics/logs/OID/tools/duplicateDN.log`. This is just for information purpose. The `bulkload` tool does not generate duplicate data for duplicate entries. It ignores duplicate entries.

Use a text editor to fix all bad entries, then re-run `bulkload` with the `check` and `generate` options. Repeat until there are no errors, or until the remaining errors are acceptable to you. For example, you might be willing to load a small number of entries with `ldapadd`.

The `bulkload` tool generates intermediate `*.ctl` and `*.dat` files in the `ORACLE_INSTANCE/OID/load` directory. Even when errors occur, `bulkload` generates the intermediate files for those entries that had no check errors.

When `bulkload` completes successfully or with acceptable errors, you can use the intermediate files with the `SQL*Loader` in `load` mode. Do not modify these files.

Note: Always use the `check` and `generate` options together if you plan to ignore check-related errors. If you use the `generate` option without the `check` option, none of the validation checks are performed. In that case, the intermediate files will contain erroneous entries. Loading such files can lead to data inconsistency and index creation failures.

Task 5: Loading the Input Files

After you have generated the input files, run `bulkload` with the `load` option. During this step, `bulkload` loads the `*.dat` files, which are in Oracle `SQL*Loader` specific format, into the database, creates attribute indexes, and generates database statistics. The syntax is:

```
bulkload connect="connect_string" load="TRUE"
```

The tool will indicate any errors on the screen. All loading errors are reported in the `ORACLE_INSTANCE/diagnostics/logs/OID/tools` directory. They reside in `bulkload.log` and in the `SQL*Loader`-generated files `*.bad` and `bsl_*.log`.

If `load` fails, the database might be in an inconsistent state. Restore the database to its state prior to the `bulkload` operation, either by using `bulkload` with the `recover` option or by restoring Oracle Internet Directory directory from a backup taken before you invoked `bulkload`. Then repeat the command:

```
bulkload connect="connect_string" load="TRUE"
```

If you encounter an error during the indexing phase, you can use:

```
bulkload connect="con_str" index=true
```

to re-create all indexes.

If you encounter an error during database statistics generation, you can use the `oidstats.sql` command to generate statistics.

See Also: The "oidstats.sql" command reference in *Oracle Fusion Middleware Reference for Oracle Identity Management*

Loading Data in Incremental or Append Mode By Using bulkload

If you must add entries to an Oracle Internet Directory server that already contains data, and the server must be up and running at the same time, then you must use the

incremental or append mode. This mode is usually faster than other methods of adding entries to the directory. However, you must ensure that the Oracle Internet Directory LDAP instances are in read-modify mode so that bulkload can append data.

You invoke `bulkload` in incremental or append mode with command lines similar to these:

```
bulkload connect="conn_str" \  
  check="TRUE" generate="TRUE" append="TRUE" file="LDIF_file"  
bulkload connect="conn_str" \  
  load="TRUE" append="TRUE"
```

Performing Index Verification By Using bulkload

The `bulkload` operation can either update indexes or create indexes. Sometimes, however, `bulkload` does not update or create the indexes properly. This is typically due to issues like improper sizing. If this happens, you can use `bulkload` to verify and re-create all the indexes.

Use the following syntax to invoke `bulkload` for verification of indexes:

```
bulkload connect="conn_str" \  
  check="TRUE" index="TRUE"
```

Re-Creating Indexes By Using bulkload

To re-create indexes, use the following syntax:

```
bulkload connect="conn_str" index="TRUE"
```

Recovering Data After a Load Failure By Using bulkload

The `load` phase of `bulkload` can fail because of issues like improper disk sizing. After such a failure, the directory data might be inconsistent. You can use the `recover` option to return the directory data to its pre-`bulkload` state. The syntax is:

```
bulkload connect="conn_str" recover="TRUE"
```

Modifying Attributes of a Large Number of Entries By Using bulkmodify

The `bulkmodify` tool is useful for modifying the attributes of a large number of entries in an existing directory. It can perform add and replace operations on attribute values. It can operate on a naming context. Using filters, it can also operate selectively on a few entries under a specified naming context.

The `bulkmodify` tool does not allow add or `replace` operations on the following attributes:

- `dn`
- `cn`
- `userpassword`
- `orclpassword`
- `orclentrylevelaci`
- `orclaci`
- `orclcertificatehash`
- `orclcertificatematch`

- any binary attribute

It does not allow `replace` operation on the attribute `objectclass`.

It does not allow `add` for single-valued attributes.

Output from `bulkmodify` is logged in `ORACLE_INSTANCE/diagnostics/logs/OID/tools/bulkmodify.log`.

See Also: The `bulkmodify` command-line tool reference in *Oracle Fusion Middleware Reference for Oracle Identity Management*

`bulkmodify` has the following syntax.

```
bulkmodify connect=connect_string basedn=Base_DN
{[add="TRUE"|"FALSE"]|[replace="TRUE"|"FALSE"]} attribute=attribute_name
value=attribute_value [filter=filter_string] [size=transaction_size]
[threads=num_of_threads] [debug="TRUE"|"FALSE"] [encode=character_set]
[verbose="TRUE"|"FALSE"]
```

The number of threads should be from one to six times the number of processors.

Select either the `add` or the `replace` option. By default both are set to `FALSE`.

Note: Before using `bulkmodify`, ensure that the environment variable `ORACLE_INSTANCE` has been set to the full path name of the Oracle instance.

Adding a Description for All Entries Under a Specified Naming Context

This example adds descriptions for all the entries under "`c=us`".

```
bulkmodify connect="connect_str" baseDN="c=us" add="TRUE" \
attribute="description" value="US citizen" filter="objectclass=*
```

Adding an Attribute for Entries Under a Specified Naming Context Matching a Filter

This example adds `telephonenumber` for all the entries under "`c=us`" that have the manager Anne Smith.

```
bulkmodify connect="connect_str" baseDN="c=us" add="TRUE" \
attribute="telephoneNumber" \
value="408-123-4567" filter="manager=cn=Anne Smith"
```

Replacing an Attribute for All Entries Under a Specified Naming Context

This example replaces `pwdreset` for all the entries under "`c=us`".

```
bulkmodify connect="connect_str" baseDN="c=us" replace="TRUE" \
attribute="pwdreset" value="1" filter="objectclass=*
```

Deleting Entries or Attributes of Entries by Using bulkdelete

`bulkdelete` is useful for deleting the attributes of a large number of entries in an existing directory. `bulkdelete` can delete entries specified under a naming context. By default, it deletes entries completely. It removes all traces of an entry from the

database. If you use the option `cleandb FALSE`, `bulkdelete` turns all entries into tombstone entries instead of deleting them completely.

Bulkdelete output is logged in `ORACLE_INSTANCE/diagnostics/logs/OID/tools/bulkdelete.log`.

See Also: The `bulkdelete` command-line tool reference in *Oracle Fusion Middleware Reference for Oracle Identity Management*

The `bulkdelete` tool has the following syntax.

```
bulkdelete connect=connect_string {[basedn=Base_DN] | [file=file_name]}
[cleandb="TRUE"|"FALSE"] [size=transaction_size] [encode=character_set]
[debug="TRUE"|"FALSE"] [threads=num_of_threads] [verbose="TRUE"|"FALSE"]
```

Select either the `basedn` or the `file` option. If `cleandb` is `TRUE`, `bulkdelete` removes entries completely from the database. By default `cleandb` is set to `TRUE`. The number of threads should be from one to six times the number of CPUs.

Notes:

- Before using `bulkdelete`, ensure that the environment variable `ORACLE_INSTANCE` has been set to the full path name of the Oracle instance.
 - If the number of entries to be deleted in the specified naming context is large, you must tune the Oracle Database as specified in the Oracle Internet Directory chapter of *Oracle Fusion Middleware Performance and Tuning Guide*.
-
-

Deleting All Entries Under a Specified Naming Context by Using `bulkdelete`

This example deletes all the entries under "c=us".

```
bulkdelete connect="connect_str" baseDN="c=us" cleandb="TRUE"
```

Deleting Entries Under Naming Contexts and Making them Tombstone Entries

This example deletes all the entries under "c=us" and leaves them as tombstone entries.

```
bulkdelete connect="connect_str" baseDN="c=us" cleandb=FALSE
```

This example deletes all the entries under given base DNs specified in file and leaves them as tombstone entries.

```
bulkdelete connect="connect_str" file="file" cleandb=FALSE
```

Dumping Data from Oracle Internet Directory to a File by Using `ldifwrite`

The `ldifwrite` tool is used to dump of data from an Oracle Internet Directory store to a file. Having the data in a file facilitates loading the data into another node for replication or backup storage. As it writes to the output file, the `ldifwrite` tool performs a subtree search, including all entries below the specified DN, and the DN itself. It dumps data in LDIF format. It can also dump entries under a specified replication agreement DN.

The `ldifwrite` tool can dump entries located by using specified filters.

Output from `ldifwrite` is logged in `ORACLE_INSTANCE/diagnostics/logs/OID/tools/ldifwrite.log`.

See Also: The `ldifwrite` command-line tool reference in *Oracle Fusion Middleware Reference for Oracle Identity Management*

The `ldifwrite` tool has the following syntax.

```
ldifwrite connect=connect_string basedn=Base_DN ldiffile=LDIF_Filename
[filter=LDAP_Filter] [threads=num_of_threads] [debug="TRUE"|"FALSE"]
[encode=character_set] [verbose="TRUE"|"FALSE"]
```

Use the `basedn` option to specify the base DN or replication agreement DN.

The number of threads should be from one to six times the number of CPUs.

Note: Before using `ldifwrite`, ensure that the environment variable `ORACLE_INSTANCE` has been set to the full path name of the Oracle instance.

Dumping Part of a Specified Naming Context to an LDIF File

This example uses the following naming context objects defined in partial replication:

```
dn: cn=includednamingcontext000001, cn=replication namecontext,
   orclagreementid=000001, orclreplicaid=node replica identifier,
   cn=replication configuration
orclincludednamingcontexts: c=us
orclxcludednamingcontexts: ou=Americas, c=us
orclxcludedattributes: userpassword
objectclass: top
objectclass: orclreplnamectxconfig
```

In this example, all entries under "c=us" are backed up except "ou=Americas, c=us". The `userpassword` attribute is also excluded. The command is:

```
ldifwrite connect="conn_str" \
  baseDN="cn=includednamingcontext000001, cn=replication namecontext, \
  orclagreementid=000001,orclreplicaid=node replica identifier,\
  cn=replication configuration" ldiffile="ldif_file_name"
```

Dumping Entries Under a Specified Naming Context to an LDIF File

This example writes all the entries that satisfy LDAP search filter criteria under "ou=Europe, o=imc, c=us" into the `output.ldif` file.

```
ldifwrite connect="connect_str" baseDN="ou=Europe, o=imc, c=us" \
  filter="uid=abc" ldiffile="output.ldif"
```

Creating and Dropping Indexes from Existing Attributes by Using catalog

The `catalog` tool is useful for creating indexes for or dropping indexes from existing attributes. The `catalog` tool makes an attribute searchable.

Output from `catalog` is logged in `ORACLE_INSTANCE/diagnostics/logs/OID/tools/catalog.log`.

catalog has the following syntax.

```
catalog connect=connect_string {[add="TRUE"|"FALSE"]|[delete="TRUE"|"FALSE"]}
{[attribute=attribute_name]|[file=file_name]} [logging="TRUE"|"FALSE"]
[threads=num_of_threads] [debug="TRUE"|"FALSE"] [verbose="TRUE"|"FALSE"]
```

Select either the `add` or the `delete` option. By default both are set to `FALSE`.

The number of threads should be from one to six times the number of CPUs.

If `logging` is `TRUE`, `catalog` generates a redo log.

You can specify only one `attribute` argument on the command line at a time. To add or delete more than one attribute in a single command invocation, use the `file` option and specify a list of attributes in the file. Use one line for each attribute, for example:

```
description
sn
title
```

Notes:

- Before using `catalog`, ensure that the environment variable `ORACLE_INSTANCE` has been set to the full path name of the Oracle instance.
 - The `catalog` command cannot index more than 1000 attributes at a time. If more than 1000 attributes are present in the file, the tool throws an error. If you need to index more than 1000 attributes, use multiple files.
-
-

Changing a Searchable Attribute into a Non-searchable Attribute

This example drops an index from the attribute `title`.

```
catalog connect="connect_str" delete="TRUE" attribute="title"
```

Note: Unless you are absolutely sure that the indexes were not created by the base schema that was installed with Oracle Internet Directory, be careful not to use the `catalog delete=T` option to remove indexes from attributes. Removing indexes from base schema attributes can adversely impact the operation of Oracle Internet Directory.

Changing a Non-searchable Attribute into a Searchable Attribute

This example adds an index to the attribute `title`.

```
catalog connect="connect_str" add="TRUE" attribute="title"
```

See Also:

- ["Indexing an Attribute for Which Data Exists by Using the Catalog Management Tool" on page 20-21](#)
- ["Adding an Index to a New Attribute by Using Oracle Directory Services Manager" on page 20-15](#)
- ["Adding an Index to an Existing Attribute by Using Oracle Directory Services Manager" on page 20-15](#)
- ["Configuring Specific Attributes for Referential Integrity by Using the Command Line" on page 21-3](#)

Managing Collective Attributes

This chapter describes collective attributes in Oracle Internet Directory and explains how to manage them.

This chapter contains the following topics:

- [Introduction to Collective Attributes](#)
- [Managing Collective Attributes by Using the Command Line](#)

Introduction to Collective Attributes

Attributes shared by the entries comprising an entry collection are called collective attributes. Values of collective attributes are visible but not updatable to clients accessing entries within the collection. As administrator, you manage collective attributes by defining and modifying the associated collective attributes sub entry.

See Also : RFC 3671 "Collective Attributes in the Lightweight Directory Access Protocol (LDAP)" and RFC 3672 "Subentries in the Lightweight Directory Access Protocol (LDAP)" at <http://www.ietf.org> for more information.

The RFC Definition and Oracle Extensions

RFC 3671 describes a specific schema for collective attributes. If you want to, you can define and use the collective attribute schema exactly as described in the RFC. Oracle Internet Directory, however, extends the definition of collective attributes to make them easier to use.

RFC 3671

According to RFC 3671, you must define each collective attribute schema before you can use it in the collective subentry. For example, if you want to use the telephone number attribute as a collective attribute, then you define the schema for the `c-telephoneNumber` in the directory like this:

```
( 2.5.4.20.1 NAME 'c-TelephoneNumber' SUP telephoneNumber  
  COLLECTIVE )
```

In addition, the collective attribute must be multivalued.

Oracle Extensions

Oracle extends the usage as follows:

- You do not need a schema definition for a collective attribute. You can use any attribute as a collective attribute.

- To make an attribute a collective attribute, create it in the collective subentry with the subtype `collective`.
- A collective attribute can be either multivalued or single valued.

The rest of this chapter describes Oracle Internet Directory usage.

Defining the Collective Attribute Subentry

You create a collective attribute by defining a subentry. The following example defines a collective subentry for the entries under `dc=mycompany, dc=com`. This subentry causes `TelephoneNumber` and `postalCode` to be included as collective attributes in all the entries under `dc=mycompany, dc=com`:

```
Dn: cn=collective attributes, dc=mycompany,dc=com
Cn: collective attributes
Objectclass: subentry
Objectclass: collectiveAttributeSubentry
Objectclass: top
Objectclass: extensibleobject
TelephoneNumber;collective: 1234560000
PostalCode;collective: 98765
```

Using subtreeSpecification

You can control which specific entries actually get collective attributes. You do this by using the `subtreeSpecification` attribute in the collective subentry. If no `subtreeSpecification` attribute is specified in the collective subentry then the collective attributes are included in all the child entries where the collective subentry is defined.

See Also : RFC 3672 "Subentries in the Lightweight Directory Access Protocol (LDAP)" at <http://www.ietf.org> for more details about the `subtreeSpecification` attribute.

The next three sections provide examples of how to use the `subtreeSpecification` attribute.

Base

You use the `base` keyword in the `subtreeSpecification` to limit a collective attribute to a subtree.

For example, to restrict collective attributes only to the subtree `cn=users, dc=mycompany, dc=com`, you can use the subentry previously shown for `dc=mycompany, dc=com`, but add a `base` value to the `subtreeSpecification` attribute in the collective subentry like this:

```
SubtreeSpecification: {base "cn=users"}
```

Minimum and Maximum

You use the `minimum` and `maximum` keywords in the `subtreeSpecification` attribute to control the number of RDNs from the base where collective attributes apply.

For example, if you want collective attributes to be added to the entries under `ou=Americas, cn=users, dc=mycompany, dc=com` but not to one level child

entries of `cn=users`, `dc=mycompany`, `dc=com`, or two levels down from `cn=users`, `dc=mycompany`, `dc=com`, then define the `subtreeSpecification` as follows:

```
SubtreeSpecification: {base "cn=users", minimum 2, maximum 4}
```

In this configuration, `cn=john doe`, `ou=Americas`, `cn=users`, `dc=mycompany`, `dc=com` gets the collective attributes, but `cn=inbox`, `cn=2009`, `cn=emailFolder`, `cn=john doe`, `ou=Americas`, `cn=users`, `dc=mycompany`, `dc=com` does not get the collective attributes because it is more than four levels from the base `cn=users`.

Specific Exclusions

You can further exclude collective attributes from specific entries by using the `specificExclusions`, `chopBefore`, and `chopAfter` keywords. For example, if you do not want to add collective attributes to `ou=Europe`, define the `subtreeSpecification` as follows:

```
SubtreeSpecification: {base "cn=users", minimum 2, maximum 4, specificExclusions { chopBefore: "ou=Europe" } }
```

If you want the collective attributes to be included in a parent DN but not its child entries, define the specification filter like this:

```
SubtreeSpecification: {base "cn=users", minimum 2, maximum 4, specificExclusions { chopBefore: "ou=Europe", chopAfter: "cn=Global User" } }
```

In this example, the entry `cn=Global User`, `ou=all region`, `cn=users`, `dc=mycompany`, `dc=com` gets the collective attributes, but the entry `cn=emailFolder`, `cn=GlobalUser`, `ou=all region`, `cn=users`, `dc=mycompany`, `dc=com` does not get the collective attributes.

If you want collective attributes to be included for a certain object class only, then specify the Object Identifier or name of the object class in the `specificationFilter` for the `subtreeSpecification` attribute. For example, to include the collective attributes to the objectclass `person` only, define the specification filter like this:

```
SubtreeSpecification: {base "cn=users", minimum 2, maximum 4, specificExclusions { chopBefore: "ou=Europe", chopAfter: "cn=GlobalUser" }, specificationFilter item:person }
```

Alternatively, you could use:

```
SubtreeSpecification: {base "cn=users", minimum 2, maximum 4, specificExclusions { chopBefore: "ou=Europe", chopAfter: "cn=GlobalUser" }, specificationFilter item:2.5.6.6 }
```

where `2.5.6.6` is the Object Identifier for objectclass `person`.

Examples of SpecificationFilter

You can use the keywords `and`, `or`, and `not` to further refine your `subtreeSpecification`, as follows:

```
SubtreeSpecification: {base "cn=users", minimum 2, maximum 4, specificExclusions { chopBefore: "ou=Europe", chopAfter: "cn=GlobalUser" }, specificationFilter and:{ item:2.5.6.6, item:2.5.6.7 } }
```

```
SubtreeSpecification: {base "cn=users", minimum 2, maximum 4, specificExclusions { chopBefore: "ou=Europe", chopAfter: "cn=GlobalUser" }, specificationFilter or:{ item:2.5.6.6, item:2.5.6.7 } }
```

```
SubtreeSpecification: {base "cn=users", minimum 2, maximum 4, specificExclusions {
chopBefore: "ou=Europe", chopAfter: "cn=GlobalUser"}, specificationFilter not:{
item:2.5.6.7} }
```

Overriding a Collective Attribute

If you want some entries to have their own values for an attribute, instead of the collective attribute value, you can specifically add that attribute to those entries and add attribute `collectiveExclusions: attributeName` to that entry.

If all the collective attributes needs to be excluded then add attribute `excludeAllCollectiveAttributes: true` to those entries. Doing so overrides the value of the collective attribute value. For example, if you add the `TelephoneNumber` attribute and the `excludeAllCollectiveAttributes: true` attribute to the entry `cn=jane smith, ou=Americas, cn=users, dc=mycompany, dc=com`, this entry will have its own value for `TelephoneNumber` instead of the collective attribute.

Managing Collective Attributes by Using the Command Line

You can manage a collective attributes sub entry from the command line, like any other directory entry.

Adding a Subentry by Using `ldapadd`

To create collective attributes, you define the collective subentry in an LDIF file using `ldapadd`, as follows:

```
ldapadd -p port_number -h host -D cn=orcladmin -q -f subentry.ldif
```

where the contents of `subentry.ldif` is something like this:

```
Dn: cn=collective attributes, dc=mycompany,dc=com
Cn: collective attributes
Objectclass: subentry
Objectclass: collectiveAttributeSubentry
Objectclass: top
Objectclass: extensibleobject
TelephoneNumber;collective: 1234560000
PostalCode;collective: 98765
SubtreeSpecification: {base "cn=users", minimum 2, maximum 4, specificExclusions {
chopBefore: "ou=Europe", chopAfter: "cn=GlobalUser"}, specificationFilter not:{
item:2.5.6.7} }
```

Modifying a Subentry by Using `ldapmodify`

Issue this command to modify the file:

```
ldapmodify -p 3060 -D "cn=orcladmin" -q -f mod_subentry.ldif
```

where `mod_subentry.ldif` is something like this:

```
dn: cn=collective attributes, dc=mycompany,dc=com
changetype: modify
replace: PostalCode;collective
PostalCode;collective: 98768
```

Managing Alias Entries

This chapter provides examples of how to add, search for, and modify alias entries, and it includes a list of messages. It contains these topics:

- [Introduction to Managing Alias Entries](#)
- [Adding an Alias Entry](#)
- [Searching the Directory with Alias Entries](#)
- [Modifying Alias Entries](#)
- [Interpreting Messages Related to Alias Dereferencing](#)

For information about attribute aliases, see "[Understanding Attribute Aliases](#)" on page 20-10.

Introduction to Managing Alias Entries

Entries sometimes have distinguished names that are long and cumbersome. Oracle Internet Directory makes it easier to administer long names by using alias objects. When someone looks up—that is, references—an object by using an alias, the alias is dereferenced, and what is returned is the object to which the alias points. For example, the alias, `Server1`, can be dereferenced so that it points to the fully qualified DN—namely, `dc=server1,dc=us,dc=myCompany,dc=com`. This feature also enables you to devise structures that are not strictly hierarchical.

An alias entry uses the object class `alias` to distinguish it from object entries in a directory. The definition of that object class is as follows:

```
(2.5.6.1 NAME 'alias' SUP top STRUCTURAL MUST aliasedObjectName)
```

An alias entry also contains the `aliasedObjectName` attribute that, in turn, contains the DN of the object to which it is pointing. The definition of that attribute is as follows:

```
(2.4.5.1 NAME 'aliasedObjectName' EQUALITY distinguishedNnameMatch SYNTAX 1.3.6.1.4.1.1466.115.121.1.12 SINGLE-VALUE)
```

[Figure 17-1](#) and the accompanying text provides an example of alias entry dereferencing.

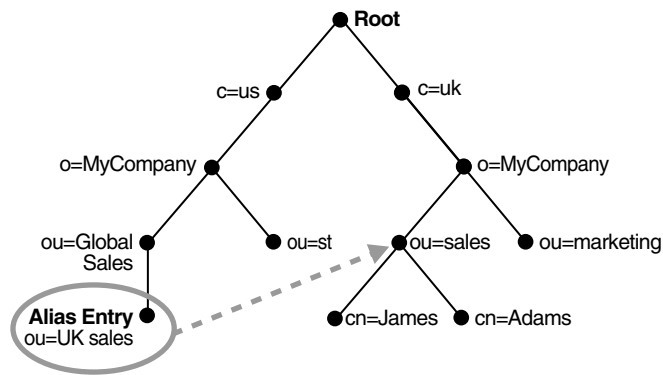
Figure 17-1 Alias Entries Example

In [Figure 17-1](#), `ou=uk sales`, `ou=global sales`, `o=myCompany`, `c=us` is an alias entry pointing to the `ou=sales`, `o=myCompany`, `c=uk` entry.

When anyone references `ou=uk sales`, `ou=global sales`, `o=oracle`, `c=us`, the directory server automatically reroutes them to the real entry, `ou=sales`, `o=oracle`, `c=uk`.

Adding an Alias Entry

To add an alias entry, you create a normal entry in LDIF and an alias entry pointing to the real entry. Following the steps in this example produces the tree in [Figure 17-2](#) on page 17-3.

1. Create a sample LDIF file, `My_file.ldif`, with the following entries:

```
dn: c=us
c: us
objectclass: country

dn: o=MyCompany, c=us
o: MyCompany
objectclass: organization

dn: ou=Areal, c=us
objectclass: alias
objectclass: extensibleobject
ou: Areal
aliasedObjectName: o=MyCompany, c=us

dn: cn=John Doe, o=MyCompany, c=us
cn: John Doe
sn: Doe
objectclass: person

dn: cn=President, o=MyCompany, c=us
objectclass: alias
objectclass: extensibleobject
cn: President
aliasedobjectname: cn=John Doe, o=MyCompany, c=us
```

2. Add these entries to the directory by using the following command:

```
ldapadd -p port -h host -D cn=orcladmin -q -f My_file.ldif
```

Note: If you attempt to add an alias entry whose parent is an alias entry, the directory server returns an error.

See Also: [Entry Alias Dereferencing Messages](#) on page 17-6 for error messages

Figure 17-2 Resulting Tree when Creating the *My_file.Idif*

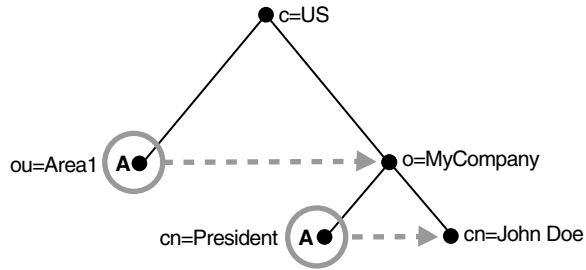

In [Figure 17-2](#), the letter A represents an alias entry, where:

- `ou=Area1` is an alias pointing to `o=MyCompany`
- `cn=President` is an alias pointing to `cn=John Doe`

Searching the Directory with Alias Entries

In each search you specify, there are flags you can set. The search is performed based on the flag you specify, as shown in [Table 17-1](#).

Table 17-1 Flags for Searching the Directory with Alias Entries

Flag	Search Behavior of LDAP Server
<code>-a never</code>	Never dereferences aliases.
<code>-a find</code>	Dereferences the base object in a search, but does not dereference alias entries that are under the base.
<code>-a search</code>	Dereferences aliases in subordinates of the base object in search but not in locating the base object of the search.
<code>-a always</code>	Dereferences aliases both in searching and in locating the base object of the search.

By default, the dereference flag in `ldapsearch` is `-a never` and thus the directory server does not perform any dereferencing for alias entries.

Searching the Base with Alias Entries

A base search finds the top level of the alias entry you specify.

Base Search with the Dereferencing Flag `-a find`

This example shows a base search of `ou=Area1, c=us` with a filter of `"objectclass=*"` with the dereferencing flag set to `-a find`.

```
ldapsearch -p port -h host -b "ou=Area1,c=us" -a find -s base "objectclass=*"
```

The directory server, during the base search, looks up the base specified in the search request and returns it to the user. However, if the base is an alias entry and, as in the example, `-a find` is specified in the search request, then the directory server automatically dereferences the alias entry and returns the entry it points to. In this example, the search dereferences `ou=Area1, c=us`, which is an alias entry, and returns `o=MyCompany, c=us`.

Base Search with the Dereferencing Flag `-a search`

This example shows a base search of `ou=Area1, c=us` with a filter of `"objectclass=*"` with the dereferencing flag set to `-a search`.

```
ldapsearch -p port -h host -b "ou=Area1,c=us" -a search -s base "objectclass=*" 
```

The directory server, during the base search, looks up the base specified in the search request and returns it to the user without dereferencing it. It returns `ou=Area1, c=us`.

Base Search with the Dereferencing Flag `-a always`

This example shows a base search of `ou=Area1, c=us` with a filter of `"objectclass=*"` with the dereferencing flag set to `-a always`.

```
ldapsearch -p port -h host -b "ou=Area1,c=us" -a always -s base "objectclass=*" 
```

The directory server, during the base search, looks up the base specified in the search request. If it is an alias entry, the directory server automatically dereferences the alias entry and returns the entry it points to. In this example, the search dereferences `ou=Area1, c=us`, which is an alias entry, and returns `o=MyCompany, c=us`.

Searching One-Level with Alias Entries

A one-level search finds only the children of the base level you specify.

One-Level Search with the Dereferencing Flag `-a find`

This example shows a one-level search of `"ou=Area1, c=us"` with a filter of `"objectclass=*"` with the dereferencing flag set to `-a find`.

```
ldapsearch -p port -h host -b "ou=Area1,c=us" -a find -s one "objectclass=*" 
```

The directory server returns one-level entries under the base that match the filter criteria. In the example, `-a find` is specified in the search request, and thus the directory server automatically dereferences while looking up the base (the first step), but does not dereference alias entries that are one level under the base. Therefore, the search dereferences `ou=Area1, c=us`, which is an alias entry, and then looks up one-level entries under `o=MyCompany, c=us`. One of the one-level entries is `cn=President, o=MyCompany, c=us` that is not dereferenced and is returned as is.

Thus, the search returns `cn=President, o=MyCompany, c=us` and `cn=John Doe, o=MyCompany, c=us`.

One-Level Search with the Dereferencing Flag `-a search`

This example shows a one-level search of `"ou=Area1, c=us"` with a filter of `"objectclass=*"` with the dereferencing flag set to `-a search`.

```
ldapsearch -p port -h host -b "ou=Area1,c=us" -a search -s one "objectclass=*" 
```

The directory server searches for the base that is specified in the search request. If the base entry is an alias entry, it returns nothing. (Alias entries cannot have children.) Otherwise, it returns the base entry's immediate children after dereferencing them. In

this example, the base entry is "ou=Area1,c=us", which is an alias entry, so the search returns nothing

One-Level Search with the Dereferencing Flag `-a always`

This example shows a one-level search of "ou=Area1,c=us" with a filter of "objectclass=*" with the dereferencing flag set to `-a always`.

```
ldapsearch -p port -h host -b "ou=Area1,c=us" -a always -s one "objectclass=*"
```

In the example, `-a always` is specified in the search request, and thus the directory server automatically dereferences while looking up the base (the first step), then dereference alias entries that are one level under the base. Therefore, the search dereferences ou=Area1,c=us, which is an alias entry, and then looks up one-level entries under o=MyCompany,c=us. One of the one-level entries is cn=President,o=MyCompany,c=us. That is dereferenced and is returned as cn=John Doe,o=MyCompany,c=us. The other one-level entry is cn=John Doe,o=MyCompany,c=us, which has already been returned.

Thus, the search returns cn=John Doe,o=MyCompany,c=us.

Searching a Subtree with Alias Entries

A subtree search finds the base, children, and grand children.

Subtree Search with the Dereferencing Flag `-a find`

This example shows a subtree search of "ou=Area1,c=us" with a filter of "objectclass=*" with the dereferencing flag set to `-a find`.

```
ldapsearch -p port -h host -b "ou=Area1,c=us" -a find -s sub "objectclass=*"
```

The directory server returns all entries under the base that match the filter criteria. In the example, `-a find` is specified in the search request, and thus the directory server automatically dereferences while looking up the base (the first step), but does not dereference alias entries that are under the base. Therefore, the search dereferences ou=Area1,c=us, which is an alias entry, and then looks up entries under o=MyCompany,c=us. One of the entries is cn=President,o=MyCompany,c=us that is not dereferenced and is returned as is.

Thus, the search returns:

- o=MyCompany,c=us
- cn=John doe,o=MyCompany,c=us
- cn=President,o=MyCompany,c=us

Subtree Search with the Dereferencing Flag `-a search`

This example shows a subtree search of "ou=Area1,c=us" with a filter of "objectclass=*" with the dereferencing flag set to `-a search`.

```
ldapsearch -p port -h host -b "ou=Area1,c=us" -a search -s sub "objectclass=*"
```

The directory searches for the base that is specified in the search request. If the base is an alias entry, then it returns the base entry without dereferencing it. (Alias entries cannot have children.) Otherwise it returns all entries under the base. If any alias entries are found, it dereferences them and returns all entries under them as well.

In this example, the base entry is an alias entry, ou=Area1,c=us, so the directory returns ou=Area1,c=us.

Subtree Search with the Dereferencing Flag -a always

This example shows a subtree search of "ou=Area1, c=us" with a filter of "objectclass=*" with the dereferencing flag set to -a always.

```
ldapsearch -p port -h host -b "ou=Area1,c=us" -a always -s sub "objectclass=*"
```

The directory server dereferences the base entry and returns it. It also returns all entries under the dereferenced base. If any alias entries are found, it dereferences them and returns all entries under them as well.

In this example, the base entry is ou=Area1, c=us, which is dereferenced to o=MyCompany, c=us, which is returned. There are two entries under o=MyCompany, c=us. One is cn=President, o=MyCompany, c=us, which is returned and also dereferenced to cn=John Doe, o=MyCompany, c=us, which is returned. The other entry under o=MyCompany, c=us, which has already been returned. So the result is o=MyCompany, c=us and cn=John Doe, o=MyCompany, c=us.

Modifying Alias Entries

This example shows how to modify alias entries. It creates a sample LDIF file, My_file.ldif with following entries:

```
dn: cn=President, o=MyCompany, c=us
changetype : modify
replace: aliasedobjectname
aliasedobjectname: cn=XYZ, o=MyCompany, c=us
```

Modify the alias entry using the following command:

```
ldapmodify -D "cn=orcladmin" -q -p port -h host -f My_file.ldif
```

Interpreting Messages Related to Alias Dereferencing

Table 17-2 lists the messages related to alias entry dereferencing and the corresponding meaning for each message.

Table 17-2 Entry Alias Dereferencing Messages

Message	Meaning
Alias Problem	Either of the following have occurred: <ul style="list-style-type: none"> An alias was dereferenced, but it did not point to an entry in the DIT. The user tries to add an alias entry whose parent is an alias.
Alias Dereferencing Problem	The user cannot dereference an alias because of access control issues.
No Such Object	The server cannot find the base DN specified in the search request.
Invalid DN Syntax	When adding or modifying an alias entry, if the value specified for aliasedObjectName has invalid DN syntax, then the directory server returns this error message to the client.
Success	The client operation successfully completes. When the dereferenced target does exist but does not match the filter specified in the search request, the server returns a success message with no matched entry.

Table 17-2 (Cont.) Entry Alias Dereferencing Messages

Message	Meaning
Insufficient Access Rights	The user does not have access to the dereferenced entry.

Managing Attribute Uniqueness Constraint Entries

This chapter explains attribute uniqueness in Oracle Internet Directory. It contains these topics:

- [Introduction to Managing Attribute Uniqueness Constraint Entries](#)
- [Specifying Attribute Uniqueness Constraint Entries](#)
- [Managing an Attribute Uniqueness Constraint Entry by Using Oracle Directory Services Manager](#)
- [Managing an Attribute Uniqueness Constraint Entry by Using the Command Line](#)

Introduction to Managing Attribute Uniqueness Constraint Entries

When you use the LDAP tools, the attribute uniqueness feature prevents duplication of attribute values, both when adding and modifying them. For example, it prevents you from assigning to a new employee an identifier already assigned to another employee. Instead, the directory server terminates the operation and returns an error message.

You can define attribute uniqueness:

- Across the entire directory
For example, to ensure that every entry in your directory that includes a `mail` attribute has a unique value for that attribute, you create an instance of attribute uniqueness associated with `mail`.
- Across one subtree for each attribute
For example, suppose that MyCompany hosts the directories for SubscriberCompany1 and SubscriberCompany2. You can choose to enforce attribute uniqueness in SubscriberCompany1 only.
- Across one object class
For example, suppose that `ID` is an attribute in both the `machine` object class and the `person` object class. If attribute uniqueness is enabled, then the directory server prevents you from adding either two machines or two people with the same `ID`. You can, however, add a `machine ID` attribute that has the same value as an existing `person ID` attribute. Similarly, you can add a `person ID` attribute that has the same value as an existing `machine ID` attribute.

Note: The LDAP tools support attribute uniqueness. The bulk tools do not.

To implement attribute uniqueness, you create an attribute uniqueness constraint entry in which you provide values for the attributes in [Table 18–1](#) on page 18-2.

Attribute uniqueness constraint entries are stored under `cn=unique`, `cn=Common`, `cn=Products`, `cn=OracleContext`.

Table 18–1 Attribute Uniqueness Constraint Entry

Attribute Name	Mandatory?	Valid Value	Default Value	Default Effect
<code>orcluniqueattrname</code>	Yes	Any string	N/A	N/A
<code>orcluniquescope</code>	No	One of the following: <ul style="list-style-type: none"> ■ <code>base</code>: Searches the root entry only ■ <code>onelevel</code>: Searches one level only ■ <code>sub</code>: Searches the entire directory 	<code>sub</code>	Searches the entire directory
<code>orcluniqueenable</code>	No	Either 0 (disable) or 1 (enable)	0	Disables attribute uniqueness
<code>orcluniquesubtree</code>	No	Any string	" "	Searches the entire directory
<code>orcluniqueobjectclass</code>	No	Any string	" "	Searches all object classes

When you have created the entry and specified the attributes, before it performs an operation, the directory server:

- Uses the attribute uniqueness constraint to check all update operations
- Determines whether the operation applies to a monitored attribute, subtree, or object class

If an operation applies to a monitored attribute, suffix, or object class, and would cause two entries to have the same attribute value, then the directory server terminates the operation and returns a constraint violation error message to the client.

Note: The attribute uniqueness feature works on indexed attributes only.

When an attribute uniqueness constraint is present in the Oracle Internet Directory replication environment, be careful about configuring the attribute uniqueness constraints on each server.

This section contains these topics:

- [Simple Replication Scenario](#)
- [Multimaster Replication Scenario](#)

Simple Replication Scenario

Because all modifications by client applications are performed on the supplier server, the attribute uniqueness constraint should be enabled on that server. It is not necessary to enable the attribute uniqueness constraint on the consumer server. Enabling the attribute uniqueness constraint on the consumer server does not prevent the directory server from operating correctly, but it can cause a performance degradation.

Multimaster Replication Scenario

In a multimaster replication scenario, nodes serve as both suppliers and consumers of the same replica. Multimaster replication uses a loosely consistent replication model.

Enabling an attribute uniqueness constraint on one of the servers does not ensure that attribute values are unique across both masters at any given time. Enabling an attribute uniqueness constraint on only one server can cause inconsistencies in the data held on each replica.

The attribute uniqueness constraint must be enabled on both masters. However, there may still be an inconsistent state. For example, in both masters we can successfully modify entries to the same attribute value. However, when the changes are later replicated to the other node, the conflict becomes apparent. You must take this type of conflict resolution into consideration as well, deciding whether conflict resolution should be the replication server's responsibility.

Specifying Attribute Uniqueness Constraint Entries

Attribute uniqueness constraint entries are stored under `cn=unique`, `cn=Common`, `cn=Products`, `cn=OracleContext`.

This section describes and gives examples of rules you follow when creating attribute uniqueness constraints. It contains these topics:

- [Specifying Multiple Attribute Names in an Attribute Uniqueness Constraint](#)
- [Specifying Multiple Subtrees in an Attribute Uniqueness Constraint](#)
- [Specifying Multiple Scopes in an Attribute Uniqueness Constraint](#)
- [Specifying Multiple Object Classes in an Attribute Uniqueness Constraint](#)
- [Specifying Multiple Subtrees, Scopes, and Object Classes in an Attribute Uniqueness Constraint](#)

To understand the examples in this section, refer to [Figure 18-1](#).

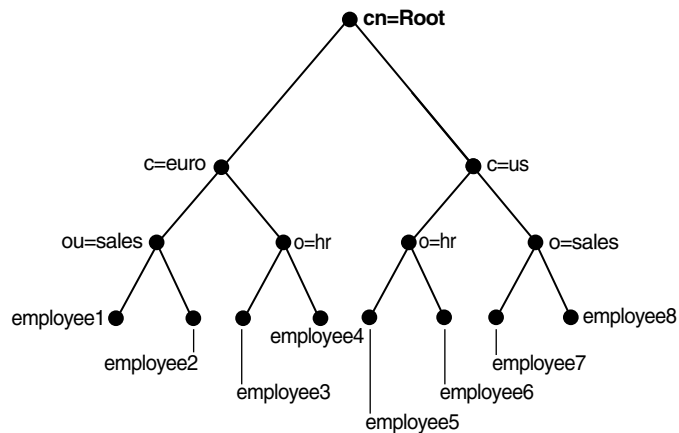
Figure 18–1 Example of a Directory Information Tree

Specifying Multiple Attribute Names in an Attribute Uniqueness Constraint

When multiple attribute uniqueness constraints have different values in `orcluniqueattrname`, their effects are independent of each other.

For example, suppose that a user defines two attribute uniqueness constraints as follows:

Constraint1:

```
orcluniqueattrname: employee_id
```

Constraint2:

```
orcluniqueattrname: email_id
```

In this example, Constraint1 and Constraint2 enforce uniqueness on the specified attribute within their own attribute uniqueness scopes. Constraint1 and Constraint2 are independent of each other.

Specifying Multiple Subtrees in an Attribute Uniqueness Constraint

When multiple attribute uniqueness constraints have the same values in `orcluniqueattrname`, `orcluniquescope` and `orcluniqueobjectclass`, but different values in `orcluniquesubtree`, the subtree scopes specified by those attribute uniqueness constraints are checked individually.

For example, refer to [Figure 18–1](#) on page 18-4. Suppose that a user defines two attribute uniqueness constraints as follows:

Constraint1:

```
orcluniqueattrname: employee_id
orcluniquesubtree: o=sales, c=us, cn=root
orcluniquescope: onelevel
```

Constraint2:

```
orcluniqueattrname: employee_id
orcluniquesubtree: o=hr, c=euro, cn=root
orcluniquescope: onelevel
```

In this example, the attribute uniqueness on `employee_id` is enforced against all entries under subtree `o=sales, c=us, cn=root`. Attribute uniqueness on

`employee_id` is also enforced against all entries under `o=hr,c=euro,cn=root` independent of the entries under the subtree `o=sales,c=us,cn=root`—that is, the directory server enforces the unique value of the `employee_id` attribute for `employee3` and `employee4`. Unique `employee_id` is enforced for `employee7` and `employee8` as well while `employee7` could have the same `employee_id` as `employee4`.

Specifying Multiple Scopes in an Attribute Uniqueness Constraint

When multiple attribute uniqueness constraints have the same values in `orcluniqueattrname`, `orcluniquesubtree` and `orcluniqueobjectclass`, but different values in `orcluniquescopes`, the attribute uniqueness constraint with the largest search scope takes effect.

For example, referring to [Figure 18–1](#) on page 18-4, suppose that a user defines two attribute uniqueness constraints as follows:

Constraint1:

```
orcluniqueattrname: employee_id
orcluniquesubtree: c=us, cn=root
orcluniquescopes: onelevel
```

Constraint2:

```
orcluniqueattrname: employee_id
orcluniquesubtree: c=us, cn=root
orcluniquescopes: sub
```

In this example, the attribute uniqueness on `employee_id` is enforced against all entries under the subtree `c=us, cn=root` and the entry `c=us, cn=root` itself. Note that this is the same as if the user had defined only `Constraint2`.

Specifying Multiple Object Classes in an Attribute Uniqueness Constraint

When multiple attribute uniqueness constraints have the same values in `orcluniqueattrname`, `orcluniquesubtree`, and `orcluniquescopes`, but different values in `orcluniqueobjectclass`, then the union of attributes belonging to those object classes is checked.

For example, look at [Figure 18–1](#) on page 18-4. Suppose that a user defines two attribute uniqueness constraints as follows:

Constraint1:

```
orcluniqueattrname: employee_id
orcluniquesubtree: c=us, cn=root
orcluniqueobjectclass: person
```

Constraint2:

```
orcluniqueattrname: employee_id
orcluniquesubtree: c=us, cn=root
```

In this example, the attribute uniqueness on `employee_id` is enforced against all entries under the subtree `c=us, cn=root` and the entry `c=us, cn=root` itself, no matter what object class those entries belong to. Note that `Constraint2` specifies no `orcluniqueobjectclass` attribute, which is the same as specifying all object classes.

Specifying Multiple Subtrees, Scopes, and Object Classes in an Attribute Uniqueness Constraint

When multiple attribute uniqueness constraints have the same values in `orcluniqueattrname`, but different values in `orcluniquesubtree`, `orcluniquescope`, and `orcluniqueobjectclass`, the entries that belong to the attribute uniqueness scopes of different constraints are checked individually.

For example, referring to [Figure 18-1](#) on page 18-4, suppose that a user defines two attribute uniqueness constraints as follows:

Constraint1:

```
orcluniqueattrname: employee_id
orcluniquesubtree: o=sales, c=us, cn=root
orcluniquescope: onelevel
orcluniqueobjectclass: person
```

Constraint2:

```
orcluniqueattrname: employee_id
orcluniquesubtree: c=euro, cn=root
orcluniquescope: sub
orcluniqueobjectclass: organization
```

In this example, the attribute uniqueness on `employee_id` is enforced against each of the following independent of each other:

- All entries one level under the entry `o=sales, c=us, cn=root` with the object class `person`
- All entries under subtree `c=euro, cn=root` and the entry `c=euro, cn=root` itself with the object class `organization`

Managing an Attribute Uniqueness Constraint Entry by Using Oracle Directory Services Manager

You can manage an attribute uniqueness constraint policy by using Oracle Directory Services Manager.

Creating an Attribute Uniqueness Constraint Entry by Using ODSM

1. Invoke Oracle Directory Services Manager and connect to the Oracle Internet Directory server as described in "[Invoking Oracle Directory Services Manager](#)" on page 7-9.
2. Select **Advanced** from the task selection bar.
3. Expand **Attribute Uniqueness** in the left pane.
4. On the toolbar, choose the **Create an attribute uniqueness constraint** icon. This displays the New Constraint window.
5. In the New Constraint dialog box, enter values in the text fields and select the **Unique Attribute Scope**. You can click **Browse** to select the Unique Attribute Subtree.
6. If you want to enable the constraint now, click Enable **Unique Attribute**.
7. Choose **OK**. The entry you just created appears in the list of attribute uniqueness constraint entries in the left panel.

8. Click **Apply** to apply this constraint or **Revert** to revert to the state before you created the new entry.

Modifying an Attribute Uniqueness Constraint Entry by Using ODSM

1. Invoke Oracle Directory Services Manager and connect to the Oracle Internet Directory server as described in "[Invoking Oracle Directory Services Manager](#)" on page 7-9.
2. Select **Advanced** from the task selection bar.
3. Expand **Attribute Uniqueness** in the left pane.
4. Select an existing uniqueness constraint. This displays the General tab of the Attribute Uniqueness Constraint window.
5. Enter or modify values.
6. If you want to enable the constraint now, click Enable **Unique Attribute**.
7. Click **Apply** to apply this change or **Revert** to revert to the state before you modified the entry.

Deleting an Attribute Uniqueness Constraint Entry by Using ODSM

To delete an attribute uniqueness constraint policy:

1. Invoke Oracle Directory Services Manager and connect to the Oracle Internet Directory server as described in "[Invoking Oracle Directory Services Manager](#)" on page 7-9.
2. Select **Advanced** from the task selection bar.
3. Expand **Attribute Uniqueness** in the left pane.
4. In the left panel, select the attribute uniqueness constraint entry you want to delete.
5. Choose the **Delete** icon, then, when prompted, confirm the deletion. The entry you deleted no longer appears in the list of attribute uniqueness constraint entries in the left panel.
6. Click **Apply** to apply this change or **Revert** to revert to the state before you deleted the entry.

Managing an Attribute Uniqueness Constraint Entry by Using the Command Line

You can manage an attribute uniqueness constraint policy by using the command line.

Creating Attribute Uniqueness Across a Directory by Using Command-Line Tools

To create an instance of attribute uniqueness across an entire directory, specify an attribute name for which you want to enforce value uniqueness.

For example, to make employee identifiers unique for all US employees at MyCompany, you would follow these steps:

1. Create an attribute uniqueness constraint entry (in LDIF format) as follows:

```
dn: cn=constraint1, cn=unique, cn=common, cn=products, cn=oraclecontext  
objectclass: orclUniqueConfig
```

```
orcluniqueattrname: employeenumber
orcluniquesubtree: o=MyCompany, c=US
orcluniqueobjectclass: person
```

2. Apply the attribute uniqueness feature by loading the attribute uniqueness constraint entry as follows:

```
ldapadd -h host -p port -D DN -q -f constraint1.ldif
```

3. Restart the directory server.

Example:

The following LDIF file, `uniquenessConstraint.ldif`, specifies a uniqueness constraint for the `orclcommonusername` attribute:

```
# Use this LDIF file to set up a uniqueness constraint on the nickname
# attribute within the user search base.
# Before running the script, change the following parameters in the LDIF file.
# <userid_attribute> - Specify the name of the attribute that holds the user
# id. This value should be the same as the orclcommonusername attribute
# configured for the realm.
# <dn_of_user_search_base> - Specify the user search base in which the
# uniqueness constraint should be enforced.
#
dn: cn=<userid_attribute>,cn=unique,cn=common,cn=Products,cn=OracleContext
changetype: add
objectclass: orclUniqueConfig
orcluniqueattrname: <userid_attribute>
orcluniquesubtree: <dn_of_user_search_base>
orcluniqueenable:1
```

Creating Attribute Uniqueness Across One Subtree by Using Command-Line Tools

To create an instance of attribute uniqueness across one or more subtrees, specify:

- An attribute name for which you want to enforce value uniqueness
- Subtree locations under which you want the uniqueness constraint to be enforced

For example, suppose that MyCompany hosts the directories for SubscriberCompany1 and SubscriberCompany2, and you want to enforce the uniqueness of the employee identifier attribute in SubscriberCompany1 only. When you add an entry such as `uid=dlin,ou=people,o=SubscriberCompany1,dc=MyCompany,dc=com`, you must enforce uniqueness only in the `o=SubscriberCompany1,dc=MyCompany,dc=com` subtree. Do this by listing the DN of the subtree explicitly in the attribute uniqueness constraint configuration.

In this case, the LDIF file would look like this:

```
dn: cn=constraint1,cn=unique,cn=common,cn=products,cn=oraclecontext
objectclass: orclUniqueConfig
orcluniqueattrname: employeenumber
orcluniquesubtree: o=SubscriberCompany1,dc=MyCompany,dc=com
```

Creating Attribute Uniqueness Across One Object Class by Using Command-Line Tools

To create an instance of attribute uniqueness across one object class, specify:

- An attribute name for which you want to enforce value uniqueness
- Object class name

In this case, the LDIF file would look like this:

```
dn: cn=constraint1, cn=unique, cn=common, cn=products, cn=oraclecontext
objectclass: orclUniqueConfig
orcluniqueattrname: employeenumber
orcluniqueobjectclass: person
```

Use `ldapadd` to add the entry.

```
ldapadd -D "cn=orcladmin" -q -p port -D user -f file_name
```

Modifying Attribute Uniqueness Constraint Entries by Using Command-Line Tools

To modify an attribute uniqueness entry, use create an LDIF file for the entry, then use `ldapmodify` to upload it into the directory.

For example, suppose there is an existing attribute uniqueness constraint entry:

```
dn: cn=constraint1, cn=unique, cn=common, cn=products, cn=oraclecontext
objectclass: orclUniqueConfig
orcluniqueattrname: employeenumber
orcluniquesubtree: o=MyCompany, c=US
orcluniqueobjectclass: person
```

To enforce the constraint against `c=US`, instead of `o=MyCompany`, you would perform these steps:

1. Create an LDIF entry to change the `orcluniquenesssubtree`:

```
dn: cn=constraint1, cn=unique, cn=common, cn=products, cn=oraclecontext
changetype: modify
replace: orcluniquesubtree
orcluniquesubtree: o=Oracle Corporation, c=US
```

2. Use `ldapmodify` to apply the change to directory server.

```
ldapmodify -D "cn=orcladmin" -q -p port -D user -f file_name
```

3. Restart the directory server to effect this change.

Deleting Attribute Uniqueness Constraint Entries by Using Command-Line Tools

Use the `ldapdelete` command-line tool to delete an attribute uniqueness constraint policy.

1. Remove the attribute uniqueness constraint entry from the directory by using `ldapdelete`.

```
ldapdelete -D "cn=orcladmin" -q -p port -D bind_DN \
  "cn=constraint1,cn=unique,cn=common,cn=products,cn=oraclecontext"
```

2. Restart the directory server to effect this change.

Enabling and Disabling Attribute Uniqueness by Using Command-Line Tools

You can enable or disable attribute uniqueness for an existing attribute uniqueness constraint entry.

To enable attribute uniqueness for an existing attribute uniqueness constraint entry:

1. Set the `orcluniqueenable` attribute to 1 by using `ldapmodify`.

2. Restart the directory server to enable the policy.

To disable attribute uniqueness:

1. Set the `orcluniqueenable` attribute to 0 by using `ldapmodify`.
2. Restart the directory server to disable the policy.

Managing Knowledge References and Referrals

This chapter explains

See Also: ["Knowledge References and Referrals"](#) on page 3-17 for an overview of directory entries, directory information trees, distinguished names, and relative distinguished names

This Chapter contains these topics:

- [Introduction to Managing Knowledge References and Referrals](#)
- [Configuring Smart Referrals](#)
- [Configuring Default Referrals](#)

Introduction to Managing Knowledge References and Referrals

A knowledge reference, also called a referral, is represented in the directory as a particular type of entry. When you create a knowledge reference entry, you associate it with the `referral` object class and the `extensibleObject` object class. Typically, you create knowledge reference entries at the place in the DIT where you want to establish the partition.

A knowledge reference provides users with a referral containing an LDAP URL. You enter these URLs as values for the `ref` attribute. There can be multiple `ref` attributes specified for any knowledge reference entry. Similarly, there can be multiple knowledge reference entries in the DIT.

See Also: [Chapter 3, "Understanding Oracle Internet Directory Concepts and Architecture"](#) for an overview of directory partitioning and knowledge references and a description of a smart knowledge reference and a default knowledge reference

Referral caching is the process of storing referral information so that it can be easily accessed again and again. Suppose that a client queries Server A, which returns a referral to Server B. The client chases this referral and contacts Server B which performs the operation and returns the results to the client. Without referral caching, the next time the client makes the same query to Server A, the entire procedure is repeated, an unnecessary consumption of time and system resources.

However, if the referral information can be cached, then, in each subsequent query, the referral information can be obtained from cache and Server B can be contacted directly. This speeds up the operation.

Client-side referral caching enables each client to cache this referral information and use it to speed up of referral processing.

Referral entries are stored in a configuration file on the client. When a client establishes a session, it reads the referral information from this configuration file and stores them in a cache. This cache remains static, with no further updates being added during the session. From this point on, for every operation, the client looks up referral information in the cache.

The directory administrator prepares this configuration file for clients to use.

Note: The configuration file is optional for clients. If a file is not present, then client operations involving referrals still behave correctly. Thus it is not mandatory for administrator to prepare this file. The advantage of using the configuration file is that it speeds up the client/server operations involving referrals.

The configuration file consists of one or more referral sets. Each referral set consists of:

- The host name where a particular directory server is running
- One or more referral entries residing on that server

Each referral entry consists of a sequence of lines, each of which corresponds to one referral URL. The line separator is CR or LF.

```
ref_file=ref_file_content
ref_file_content=1*(referral_set)
referral_set=hostname      SEP      ref_entry_set      SEP
ref_entry_set=ref_entry    *(SEP  ref_entry)
ref_entry=1*(referralurl  SEP)
SEP=CR LF / LF
CR=0x0D
LF=0x0A
```

For example, consider two referral entries in a directory server running on host serverX:

```
dn: dc=example, dc=com
ref: ldap://serverA:3060/dc=example, dc=com
ref: ldap://serverB:3060/dc=example, dc=com

dn: dc=oracle, dc=com
ref: ldap://serverC:3060/dc=oracle, dc=com
ref: ldap://serverD:3060/dc=oracle, dc=com
```

Consider the following referral entry in a directory server running on host serverY:-

```
dn: dc=fiction, dc=com
ref: ldap://serverE:3060/dc=fiction, dc=com
```

The corresponding `referral.ora` file looks like this:

```
ServerX
ldap://serverA:3060/dc=example, dc=com
ldap://serverB:3060/dc=example, dc=com

ldap://serverC:3060/dc=oracle, dc=com
ldap://serverD:3060/dc=oracle, dc=com

ServerY
```



```
ldap://serverE:3060/dc=fiction, dc=com
```

Configuring Smart Referrals

A search result can contain regular entries along with knowledge references. When a user performs a search operation, Oracle Internet Directory looks for the knowledge reference entry within the specified scope of the search. If it finds the knowledge reference, then Oracle Internet Directory returns a referral to the client.

If a user performs an add, delete, or modify operation on an entry located below the knowledge reference entry, then Oracle Internet Directory returns the referral.

For example, suppose you want to partition the DIT based on the geographical location of the directory servers. In this example, assume that:

- The `c=us` naming context is held locally on Server A and Server B in the United States.
- The `c=uk` naming context is held locally on Server C and Server D in the United Kingdom.

In this case, you would configure knowledge references between these two naming contexts as follows:

1. On Server A and B in the United States, configure a knowledge reference for the `c=uk` object on Server C and Server D:

```
dn: c=uk
c: uk
ref: ldap://host C:3060/c=uk
ref: ldap://host D:600/c=uk
objectclass: top
objectclass: referral
objectClass: extensibleObject
```

2. Configure a similar knowledge reference on Server C and D in the United Kingdom for the `c=us` object on Server A and Server B:

```
dn: c=us
c: us
ref: ldap://host A:4000/c=us
ref: ldap://host B:5000/c=us
objectclass: top
objectclass: referral
objectClass: extensibleObject
```

Use the command-line:

```
ldapmodify -D cn=orcladmin -q -p portNum -h hostname -f ldifFile
```

Results:

- A client querying Server A or Server B with base `o=f00, c=uk` receives a referral.
- A client querying Server C or Server D with base `o=f00, c=us` receives a referral.
- An add operation of `o=f00, c=uk` on either Server A or Server B fails. Instead, Oracle Internet Directory returns a referral.

Configuring Default Referrals

Oracle Internet Directory uses the `namingcontext` attribute in the DSE to determine every directory naming context held locally by the server. Be sure that the `namingContext` attribute correctly reflects the naming context information.

See Also: [Chapter 11, "Managing Naming Contexts."](#)

You specify default referrals by entering a value for the `ref` attribute in the DSE entry. If the `ref` attribute is not in the DSE entry, then no default referral is returned.

When configuring a default referral, do not specify the DN in the LDAP URL.

For example, suppose that the DSE entry on Server A contains the following `namingContext` value:

```
namingcontext: c=us
```

Further, suppose that the default referral is:

```
Ref: ldap://host PQR:3060
```

Now, suppose that a user enters an operation on Server A that has a base DN in the naming context `c=canada`, for example:

```
ou=marketing,o=foo,c=canada
```

This user would receive a referral to the host PQR. This is because Server A does not hold the `c=canada` base DN, and the `namingcontext` attribute in its DSE does not hold the value `c=canada`.

See Also: ["Knowledge References and Referrals"](#) on page 3-17 for a conceptual discussion of knowledge references

Managing Directory Schema

This chapter explains how to administer the Oracle Internet Directory object classes and attributes.

This chapter contains these topics:

- [Introduction to Managing Directory Schema](#)
- [Managing Directory Schema by Using Oracle Directory Services Manager](#)
- [Managing Directory Schema by Using the Command Line](#)

Introduction to Managing Directory Schema

Oracle recommends that you understand the basic concepts of directory components before attempting to add to or modify the base schema in the directory.

A directory schema:

- Contains rules about the kinds of objects you can store in the directory
- Contains rules for how directory servers and clients treat information during operations such as a search
- Helps to maintain the integrity and quality of the data stored in the directory
- Reduces duplication of data
- Provides a predictable way for directory-enabled applications to access and modify directory objects

Note: Every schema object in the Oracle Internet Directory has certain limitations. For example, some objects cannot be changed. These limitations are explained as constraints and rules in this chapter.

This section contains the following topics:

- [Where Schema Information is Stored in the Directory](#)
- [Understanding Object Classes](#)
- [Understanding Attributes](#)
- [Extending the Number of Attributes Associated with Entries](#)
- [Understanding Attribute Aliases](#)
- [Object Identifier Support in LDAP Operations](#)

See Also: "LDAP Schema Overview" in *Oracle Fusion Middleware Reference for Oracle Identity Management*.

Where Schema Information is Stored in the Directory

The directory schema contains all information about how data is organized in the DIT—that is, metadata such as that for an object class, an attribute, a matching rule, and syntax. This information is stored in a special class of entry called a subentry. More specifically, Oracle Internet Directory, following LDAP Version 3 standards, stores this information in subentries of type `subSchemaSubentry`.

You can add new object classes and attribute types to a subentry of type `subSchemaSubentry`. You cannot add new matching rules and syntaxes beyond those already supported by Oracle Internet Directory.

before 10g (10.1.4.0.1) there was only one `subSchemaSubentry`, directly under the root DSE entry, called `cn=subSchemaSubentry`, and you always added object classes and attribute types directly to it. As of 10g (10.1.4.0.1), the entry `cn=subSchemaSubentry` can now have subordinate entries. Any application using Oracle Internet Directory that must add schema components can create its own `subSchemaSubentry` under `cn=subSchemaSubentry` and add the schema components to it. [Figure 20–1](#) shows some `subSchemaSubentry` entries that were defined by applications, such as `cn=userdefined1, cn=subschemasubentry` and `cn=userdefined2, cn=subschemasubentry`.

Best practice is to create one subordinate entry under `subschemasubentry` for one application or a group of applications. All the `attributeTypes` and `objectClasses` related to the application should be put under its corresponding entry under `cn=subschemasubentry`.

All the schema entries are listed in the root DSE attribute `subschemasubentry`.

Figure 20–1 Location of Schema Components in Entries of Type `subSchemaSubentry`

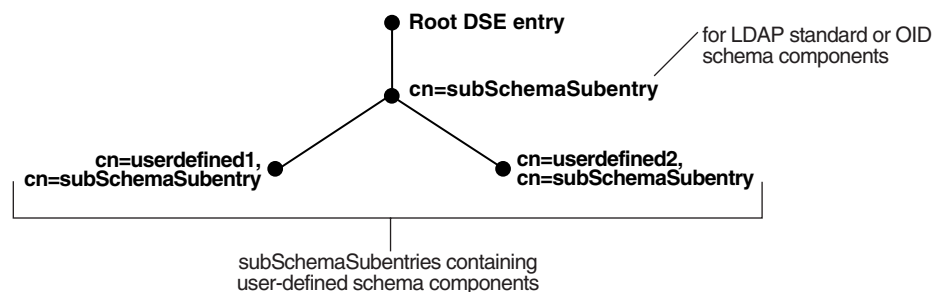

You cannot use `bulkload` to add `subSchemaSubentry` entries. You must use `ldapadd`.

Understanding Object Classes

When you add an entry, you associate it with one or more object classes. Each object class contains attributes that you want to associate with the new entry. For example, if you are creating an entry for an employee, you can associate it with the `person` object class. This object class contains many of the attributes that you want to associate with that employee entry, including, for example, name, address, and telephone number.

Note: The attribute page in the Schema tab in Oracle Directory Services Manager includes a **Referenced By** section that lists the object classes that directly reference an attribute

Each object class derives from a hierarchy of superclasses, and it inherits attributes from these superclasses. By default, all object classes inherit from the `top` object class. When you assign an object class to an entry, the entry inherits all of the attributes of both that object class and its superclasses.

The attributes that entries inherit from a super class may be either mandatory or optional. Values for optional attributes need not be present in the directory entry.

You can specify for any object class whether an attribute is mandatory or optional; however, the characteristic you specify is binding only for that object class. If you place the attribute in another object class, you can again specify whether the attribute is mandatory or optional for that object class. You can:

- Add a new, nonstandard object class and assign it existing attributes
- Select from existing standard object classes
- Modify an existing object class, assigning it a different set of attributes
- Add and modify existing attributes

See Also: "LDAP Schema Overview" in *Oracle Fusion Middleware Reference for Oracle Identity Management* for a list of schema elements installed with Oracle Internet Directory

Entries must be added in a top-down sequence—that is, when you add an entry, all of its parent entries must already exist in the directory. Similarly, when you add entries that reference object classes and attributes, those referenced object classes and attributes must already exist in the directory schema. In most cases this is not a problem because the directory server is delivered with a full set of standard directory objects.

When you add or perform an operation on an entry, you do not need to specify the entire hierarchy of superclasses associated with that entry. You can specify only the leaf object classes. Oracle Internet Directory resolves the hierarchy for the leaf object classes and enforces the information model constraints. This is often called **object class explosion**. For example, the `inetOrgPerson` object class has `top`, `person` and `organizationalPerson` as its superclasses. When you create an entry for a person, you must specify only `inetOrgPerson` as the object class. Oracle Internet Directory then enforces the schema constraints defined by the respective superclasses, namely, `top`, `person`, and `organizationalPerson`.

About Adding Object Classes

When you add object classes, keep the following in mind:

- Every structural object class must have `top` as a superclass.
- The name and the object identifier of an object class must be unique across all the schema components. The actual attribute name and any attribute name aliases must be unique across all attribute names and attribute aliases. The Object Identifier must begin with the unique identifier 2.16.840.1.113894 followed by either the Oracle-supplied prefix.9999 or a site-specific prefix.

- Schema components referred to in the object class, such as superclasses, must already exist.
- The superclass of an abstract object class must be abstract also.
- It is possible to redefine mandatory attributes in a superclass into optional attributes in the new object class. Conversely, optional attributes in a superclass can be redefined into mandatory attributes in the new object class.

See Also: ["Subclasses, Superclasses, and Inheritance"](#) on page 3-12 for a conceptual discussion of these terms

About Modifying Object Classes

This section discusses the types of modifications you can make to an existing object class. You can perform modifications through Oracle Directory Services Manager and through the command-line tools.

You can make these changes to an object class:

- Change a mandatory attribute into an optional attribute
- Add optional attributes
- Add additional superclasses
- Convert *abstract* object classes into *structural* or *auxiliary* object classes unless the abstract object class is a superclass to another abstract object class

When you modify object classes, keep these guidelines in mind:

- You cannot modify an object class that is part of the standard LDAP schema. You can, however, modify user-defined object classes.
- If existing object classes do not have the attributes you need, you can create an auxiliary object class and associate the needed attributes with that object class.
- You cannot add additional mandatory attributes to an existing object class.
- You should not modify object classes in the base schema.
- You cannot remove attributes or superclasses from an existing object class.
- You cannot convert structural object classes to other object class types.
- You should not modify an object class if there are entries already associated with it.

About Deleting Object Classes

There are also some limitations on deleting object classes:

- You cannot delete object classes from the base schema.
- You can delete object classes that are not in the base schema if they are not directly or indirectly referenced by other schema components. For example, there may be some directory entries referring to these object classes. Deleting these object classes renders these entries inaccessible.

Understanding Attributes

You must understand attributes from a conceptual standpoint before attempting operations involving attributes.

In most cases, the attributes available in the base schema will suit the needs of your organization. However, if you decide to use an attribute not in the base schema, you can add a new attribute or modify an existing one.

By default, attributes are multivalued. You can specify an attribute as single-valued by using either Oracle Directory Services Manager or command-line tools.

Note: The maximum length of a non-binary attribute value is 4000 bytes.

See Also:

- ["Attributes"](#) on page 3-8 for a conceptual discussion of attributes
- ["Attribute Options"](#) on page 3-11 for information about attribute options
- "Attribute Syntax" in *Oracle Fusion Middleware Reference for Oracle Identity Management* for information about using syntax to specify the size of the attribute value

About Adding Attributes

The rules for adding attributes are:

- The name and the object identifier of an attribute must be unique across all the schema components.
- Syntax and matching rules must agree.
- Any super attributes must already exist.
- The length of an attribute name must not exceed 127 characters.

About Modifying Attributes

The rules for modifying attributes are:

- The name and the object identifier of an attribute must be unique across all the schema components.
- The syntax of an attribute cannot be modified.
- A single-valued attribute can be made multi-valued, but a multi-valued attribute cannot be made single-valued.
- You cannot modify or delete base schema attributes.

About Deleting Attributes

The rules for deleting attributes are:

- You can delete only user-defined attributes. Do not delete attributes from the base schema.
- You can delete any attribute that is not referenced directly or indirectly by some other schema component.

If you delete an attribute that is referenced by any entry, that entry will no longer be available for directory operations.

Note: The attribute page in the Schema tab in Oracle Directory Services Manager includes a **Referenced By** section that lists the object classes that directly reference an attribute

See Also: ""Attribute Syntax" in *Oracle Fusion Middleware Reference for Oracle Identity Management* for information about using syntax to specify the size of the attribute value

About Indexing Attributes

Oracle Internet Directory uses indexes to make attributes available for searches. When Oracle Internet Directory is installed, the entry `cn=catalogs` lists available attributes that can be used in a search.

If you want to use additional attributes in search filters, you must add them to the catalog entry.

You can index a new attribute—that is, one for which no data exists in the directory—by using `ldapmodify`. You can index an attribute for which data already exists in the directory by using the Catalog Management tool. You can drop an index from an attribute by using `ldapmodify`, but Oracle recommends that you use the Catalog Management tool. You can also manage attribute indexes by using Oracle Directory Services Manager.

Notes:

- If you attempt to perform a search with a non-indexed attribute specified as a required attribute, the server returns a "Function not implemented" or "DSA unwilling to perform" error.
 - You can use Oracle Directory Services Manager to index an attribute only if it has not been used yet. You cannot use Oracle Directory Services Manager to index an attribute that is already in use. To index an attribute that is in use, use the Catalog Management tool as described in "[Indexing an Attribute for Which Data Exists by Using the Catalog Management Tool](#)" on page 20-21.
-
-

Notes: You can index only those attributes that have:

- An equality matching rule
 - Matching rules supported by Oracle Internet Directory as listed in "Attribute Matching Rules" in *Oracle Fusion Middleware Reference for Oracle Identity Management*
 - Less than 128 characters in their names
-
-

Extending the Number of Attributes Associated with Entries

You can extend the number of attributes for entries. The method you use depends on whether the entries already exist.

If the entry does not yet exist, you can extend the number of attributes before creating the entry in the directory.

For an existing entry, there are two ways to extend the attributes associated with it.

- Add names of object classes to the list in the `objectclass` attribute for each entry. If your directory is relatively small, then this can be a desirable method because it enables searches for entries based on that attribute. However, if your directory is large, then entering the names of object classes to the `objectclass` attribute can be very painstaking.
- Use content rules. This may be a more efficient way to extend the content of entries in a large directory.

This section contains these topics:

- [Extending the Number of Attributes before Creating Entries in the Directory](#)
- [Extending the Number of Attributes for Existing Entries by Creating an Auxiliary Object Class](#)
- [Extending the Number of Attributes for Existing Entries by Creating a Content Rule](#)

Extending the Number of Attributes before Creating Entries in the Directory

At installation, Oracle Internet Directory provides standard LDAP object classes and several proprietary object classes. You cannot add mandatory attributes to the sets of attributes belonging to these predefined object classes. If a given object class does not contain all the attributes that you want for an entry, then you can do one of the following:

- Define a new (base) object class
- Define an object subclass

See Also:

- "Oracle Identity Management LDAP Object Classes" in *Oracle Fusion Middleware Reference for Oracle Identity Management* for a list of object classes in the schema installed with Oracle Internet Directory
- ["Adding Object Classes by Using Oracle Directory Services Manager"](#) on page 20-11 for instructions on how to define a new object class or object subclass

Extending the Number of Attributes for Existing Entries by Creating an Auxiliary Object Class

You can create an auxiliary object class containing the additional attributes you want for your entry, and then associate that auxiliary object class with the entry. You associate the auxiliary object class with the entry by specifying it in the `objectclass` attribute for the entry.

See Also:

- ["Adding Object Classes by Using Oracle Directory Services Manager"](#) on page 20-11 for instructions on creating auxiliary object classes
- [Chapter 13, "Managing Directory Entries"](#) for instructions on associating an object class with an entry

Extending the Number of Attributes for Existing Entries by Creating a Content Rule

A content rule, following your specifications, determines the kind of content allowed in any entry that is associated with a particular structural object class. For example, you can specify that any entry associated with the `person` object class must have, in addition to the attributes in that object class, other attributes as well. The additional attributes can be those of an auxiliary object class, and they can be either mandatory or optional.

Whereas you must list auxiliary classes in the entry—which can be an administrative burden—you do not need to list content rules in the entry.

In addition to the structural object class to which it applies, a content rule can also indicate:

- Auxiliary object classes allowed for entries governed by the rule
- Mandatory attributes, in addition to those called for by the structural and auxiliary object classes, required for entries governed by the DIT content rule
- Optional attributes permitted for entries governed by the DIT content rule, in addition to those called for by structural and auxiliary object classes

This section tells you how to manage content rules by using Oracle Directory Services Manager and command-line tools.

During the process of defining a new content rule, the directory server validates the syntax and ensures that the attributes and object classes listed in the content rule have been defined in the directory.

Content rules can be specified for structural object classes only. The name of the object class is case-insensitive.

You can specify more than one content rule for each structural object class provided the content rules have different labels associated with them.

To modify an existing definition of a content rule, the client must first delete the existing definition and then add the new definition. Simple replacement of a content rule by using the `replace` command is not allowed.

To delete a content rule, the client must specify only the structural object class and the alphanumeric object identifier of the content rule. Optionally, the client can also specify the associated version of the content rule to be deleted.

Rules for Creating and Modifying Content Rules

Content rules are defined as values of the `DITContentRule` attribute in the subschema subentry (`cn=subschemasubentry`). They must conform to these rules:

- The structural object class of the entry identifies the content rule applicable for the entry. If no content rule is present for a structural object class, then entries associated with that object class contain only the attributes permitted by the structural object class definition.
- Because a content rule is associated with a structural object class, all entries of the same structural object class have the same content rule regardless of their location in the DIT.
- The content of an entry must be consistent with the object classes listed in the `objectClass` attribute of that entry. More specifically:
 - Mandatory attributes of object classes listed in the `objectClass` attribute must always be present in the entry.

- Optional attributes of auxiliary object classes indicated by the content rule can also be present even if the `objectClass` attribute does not list these auxiliary object classes.

See Also: ["Extending the Number of Attributes for Existing Entries by Creating an Auxiliary Object Class"](#) on page 20-8 for instructions on creating and managing content rules

Schema Enforcement When Using Content Rules

When validating an object for schema consistency, the directory server uses the content rule for the structural object class of the entry. It also uses all the other object classes listed in the entry.

If more than one content rule exists for an object class, then, when adding or modifying an entry, or when bulkloading data, the following rules apply.

- An entry can have attributes from all the auxiliary object classes listed in the various content rules. Not specifying an object class in the content rule does not restrict a client from explicitly adding an auxiliary object class in directory entries.
- An entry must contain values for all the mandatory attributes listed in:
 - The content rules
 - The object classes associated with the entry
 - The auxiliary object classes listed in the content rule applicable to the entry
- Optionally, an entry can contain values for any or all the optional attributes listed in:
 - The content rule
 - The object classes listed in the entry
 - The auxiliary object classes listed in the content rule applicable for the entry
- If any attribute is specified as mandatory, then it overrides any other definition that defines it as optional.

Searches for Object Classes Listed in Content Rules

Because the auxiliary object classes listed in content rules are not listed in the `objectClass` attribute for an entry, you cannot list those object classes as filters when you search for entries. Instead, base your searches on the structural object class that you are interested in. If you must base your search on an auxiliary object class, then add that auxiliary object class to the `objectClass` attribute in the user objects explicitly.

For example, a content rule for structural object class `inetOrgPerson` may specify an auxiliary object class `orclUser`. However, this does not mean that every `inetOrgPerson` entry in the directory contains `orclUser` as a value of the `objectClass` attribute. As a result, the search with the filter `objectClass=orclUser` fails. Instead of querying for an auxiliary object class contained in the content rule, you should query for structural object classes—for example, `objectClass=inetOrgPerson`.

To base a search on `objectClass=orclUser`, add `orclUser` as one of the values of `objectClass` attribute in each entry.

These considerations apply also to filters used in access control policies. If you are using a content rule to associate additional auxiliary object classes, then use only the structural object classes in the search filters.

Understanding Attribute Aliases

As of 10g (10.1.4.0.1), you can create aliases for attribute names. For example, you could create the user-friendly alias `surname` for the attribute `sn`. After you create an alias for an attribute name, a user can specify the alias instead of the attribute name in an LDAP operation.

You define an alias for an attribute in the LDAP schema definition of the attribute. The directory schema operational attribute `attributeTypes` has been enhanced to allow you to include aliases in the attribute name list. In previous releases, the format for an attribute name list was:

```
attributeTypes=( ObjectIdentifier NAME 'AttributeName' ... )
```

As of 10g (10.1.4.0.1), you may optionally specify:

```
attributeTypes=( ObjectIdentifier NAME ( 'AttributeName' 'Alias1' 'Alias2' ... )
... )
```

This is consistent with the LDAP protocol as specified by RFC 2251 and RFC 2252. In the attribute name list, the first item is recognized as the name of the attribute and rest of the items in the list are recognized as attribute aliases. For example, to specify the alias `surname` for the attribute `sn`, you would change the schema definition for `sn` from:

```
attributeTypes=( 2.5.4.4 NAME 'sn' SUP name )
```

to:

```
attributeTypes=( 2.5.4.4 NAME ( 'sn' 'surname' ) SUP name )
```

The following rules apply to attribute aliases:

- An attribute alias name must be unique throughout all the actual attribute names and other attribute aliases across all the schema components.
- When you define an attribute, the first value in the `attributeTypes` definition `NAME` field must be the actual attribute name. You define attribute aliases in the `NAME` field after the actual attribute name.
- Attribute alias names follow the same syntax rules as attribute names.
- You delete an attribute alias by redefining the attribute without the alias.

See "[Managing Directory Schema by Using the Command Line](#)" on page 20-17.

See Also: [Chapter 17, "Managing Alias Entries"](#) for information about alias entries.

Object Identifier Support in LDAP Operations

Users can substitute object identifiers for attribute names in the same way as attribute aliases.

Managing Directory Schema by Using Oracle Directory Services Manager

This section contains the following topics:

- [Searching for Object Classes by Using Oracle Directory Services Manager](#)
- [Adding Object Classes by Using Oracle Directory Services Manager](#)
- [Deleting Object Classes by Using Oracle Directory Services Manager](#)
- [Viewing Properties of Object Classes by Using Oracle Directory Services Manager](#)
- [Adding a New Attribute by Using Oracle Directory Services Manager](#)
- [Modifying an Attribute by Using Oracle Directory Services Manager](#)
- [Deleting an Attribute by Using Oracle Directory Services Manager](#)
- [Viewing All Directory Attributes by Using Oracle Directory Services Manager](#)
- [Searching for Attributes by Using Oracle Directory Services Manager](#)
- [Adding an Index to a New Attribute by Using Oracle Directory Services Manager](#)
- [Adding an Index to an Existing Attribute by Using Oracle Directory Services Manager](#)
- [Adding an Index to an Existing Attribute by Using Oracle Directory Services Manager](#)
- [Creating a Content Rule by Using Oracle Directory Services Manager](#)
- [Modifying a Content Rule by Using Oracle Directory Services Manager](#)
- [Viewing Matching Rules by Using Oracle Directory Services Manager](#)
- [Viewing Syntaxes by Using Oracle Directory Services Manager](#)

Searching for Object Classes by Using Oracle Directory Services Manager

To search for object classes by using Oracle Directory Services Manager:

1. Invoke Oracle Directory Services Manager and connect to the Oracle Internet Directory server as described in "[Invoking Oracle Directory Services Manager](#)" on page 7-9.
2. From the task selection bar, choose **Schema**.
3. Expand the Object Classes panel on the left.
4. Enter a keyword in the **Search** field and click **Go**. The list of object classes matching the keyword is displayed in the left panel.

You can use "*" and "?" as wildcards. For example, if you enter *person, the search returns all the object classes ending with person.

Select **Clear search text** to dismiss the search and return to the complete list of object classes.

Adding Object Classes by Using Oracle Directory Services Manager

To add object classes by using Oracle Directory Services Manager:

1. Invoke Oracle Directory Services Manager and connect to the Oracle Internet Directory server as described in "[Invoking Oracle Directory Services Manager](#)" on page 7-9.
2. From the task selection bar, choose **Schema**.
3. Expand the Object Classes panel on the left and, in the toolbar, choose **Create**. The New Object Class dialog box appears.

Alternatively, in the **Object Classes** panel, select an object class that is similar to one you would like to create, and then choose **Create Like**. The New Object Class dialog box displays the attributes of the selected object class. You can create the new object class by using this one as a template.

4. In the New Object Class dialog box, enter the information in the fields.
5. Choose **Create**.

See Also:

- ["Object Class Types"](#) on page 3-13
- ["Subclasses, Superclasses, and Inheritance"](#) on page 3-12
- Oracle Directory Services Manager online help for further details about adding object classes

Modifying Object Classes by Using Oracle Directory Services Manager

You can add optional, but not mandatory, attributes to an object class already in use by entries. If you add optional attributes to an object class already in use, then no special rules apply, and they are added as empty attributes to those entries.

To modify an object class:

1. Invoke Oracle Directory Services Manager and connect to the Oracle Internet Directory server as described in ["Invoking Oracle Directory Services Manager"](#) on page 7-9.
2. From the task selection bar, choose **Schema**.
3. Expand the Object Classes panel on the left. Use the scroll bar to move through the alphabetical list of object classes. You can also search for an object class as described in ["Searching for Object Classes by Using Oracle Directory Services Manager"](#) on page 20-11.
4. Click the object class you want to modify. The Object Class tab appears on the right side of the page.
5. To add or delete a superclass or attribute, select it in the **Superclass**, **Mandatory Attributes**, or **Optional Attributes** list and choose **Add** or **Delete** in the toolbar above the list

Choose **Make Optional** in the **Mandatory Attributes** toolbar to make the attribute optional.

To edit a superclass or attribute, select it in the **Superclass**, **Mandatory Attributes**, or **Optional Attributes** list and choose **Edit**. An Object Class or Attribute dialog appears. Use it to make changes to the superclass or attribute. In the Object Class dialog, you can add, delete, or edit the superclass, mandatory attributes, or optional attributes of the superclass. Click **OK** in each dialog after making change.

6. Choose **Apply** in the Object Class page to apply changes, or **Revert** to abandon changes.

See Also:

- ["Object Classes"](#) on page 3-12
- ["Subclasses, Superclasses, and Inheritance"](#) on page 3-12

Note: You can add attributes to an auxiliary object class or a user-defined structural object class.

See Also: ["Adding a New Attribute to an Auxiliary or User-Defined Object Class by Using Command-Line Tools"](#) on page 20-19 for an example of adding attributes to an auxiliary object class

Deleting Object Classes by Using Oracle Directory Services Manager

Caution: Oracle recommends that you not delete object classes from the base schema. If you delete an object class that is referenced by any entries, those entries then become inaccessible.

Deleting object classes from the base schema might also cause Oracle Directory Services Manager to malfunction.

To delete an object class by using Oracle Directory Services Manager:

1. Invoke Oracle Directory Services Manager and connect to the Oracle Internet Directory server as described in ["Invoking Oracle Directory Services Manager"](#) on page 7-9.
2. From the task selection bar, choose **Schema**.
3. Click + next to **Object Classes** to expand the Object Classes panel. Use the scroll bar to move through the alphabetical list of Object Classes.
4. Select the object class you want to delete.
5. Choose **Delete** from the toolbar, then click **Delete** in the confirmation dialog.

Viewing Properties of Object Classes by Using Oracle Directory Services Manager

To view all object classes in the schema:

1. Invoke Oracle Directory Services Manager and connect to the Oracle Internet Directory server as described in ["Invoking Oracle Directory Services Manager"](#) on page 7-9.
2. From the task selection bar, choose **Schema**.
3. Click + next to **Object Classes** to expand the Object Classes panel. Use the scroll bar to move through the alphabetical list of Object Classes.
4. Click the Object Class you want to view. The Object Class tab appears on the right side of the page.
5. To see more detail about a superclass or attribute of the object class, select the item and click Edit. Click Cancel to return to the object class panel

Adding a New Attribute by Using Oracle Directory Services Manager

To add a new attribute:

1. Invoke Oracle Directory Services Manager and connect to the Oracle Internet Directory server as described in ["Invoking Oracle Directory Services Manager"](#) on page 7-9.

2. From the task selection bar, choose **Schema**.
3. If necessary, expand the **Attributes** pane, on the left, then choose the **Create** button in the toolbar. The New Attribute Type dialog box appears.

Alternatively, in the **Attributes** panel, select an attribute that is similar to one you would like to create, and then choose **Create Like**. The New Attribute Type dialog box displays the attributes of the selected attribute. You can create the new attribute by using this one as a template.

Tip: Because equality, syntax, and matching rules are numerous and complex, it may be simpler to copy these characteristics from a similar existing attribute.

4. Enter values in each of the fields.
5. Choose **Apply**.

Notes: To use this attribute, remember to declare it to be part of the attribute set for an object class. You do this in the Object Classes pane. For further instructions, see "[Modifying Object Classes by Using Oracle Directory Services Manager](#)" on page 20-12 and "[Modifying Object Classes by Using Command-Line Tools](#)" on page 20-19.

Modifying an Attribute by Using Oracle Directory Services Manager

To modify an attribute by using Oracle Directory Services Manager:

1. Invoke Oracle Directory Services Manager and connect to the Oracle Internet Directory server as described in "[Invoking Oracle Directory Services Manager](#)" on page 7-9.
2. From the task selection bar, choose **Schema**.
3. In the **Attributes** panel, select an attribute that you would like to modify. The attribute page appears on the right.
4. Modify or add information in editable fields, if any, in the attribute tab.
5. Choose **Apply**.

Deleting an Attribute by Using Oracle Directory Services Manager

Caution: Oracle recommends that you not delete attributes or object classes from the base schema.

Deleting attributes or object classes from the base schema might cause Oracle Directory Services Manager to malfunction.

To delete an attribute:

1. Invoke Oracle Directory Services Manager and connect to the Oracle Internet Directory server as described in "[Invoking Oracle Directory Services Manager](#)" on page 7-9.
2. From the task selection bar, choose **Schema**.

3. In the **Attributes** panel, select an attribute that you would like to delete.
4. Choose **Delete** from the toolbar in the left panel, then click **Delete** in the confirmation dialog.

Viewing All Directory Attributes by Using Oracle Directory Services Manager

To view attributes by using Oracle Directory Services Manager:

1. Invoke Oracle Directory Services Manager and connect to the Oracle Internet Directory server as described in "[Invoking Oracle Directory Services Manager](#)" on page 7-9.
2. From the task selection bar, choose **Schema**.
3. Expand **Attributes**.
4. Use the scrollbar in the **Attributes** panel to move through the alphabetical list.

See Also: "[Viewing Properties of Object Classes by Using Oracle Directory Services Manager](#)" on page 20-13 for instructions about how to view attributes for a specific object class.

Searching for Attributes by Using Oracle Directory Services Manager

To search for attributes by using Oracle Directory Services Manager:

1. Invoke Oracle Directory Services Manager and connect to the Oracle Internet Directory server as described in "[Invoking Oracle Directory Services Manager](#)" on page 7-9.
2. From the task selection bar, select **Schema**.
3. Expand the **Attributes** list in the left pane.
4. Enter a search term in the Search field in the left pane. You can use an asterisk (*) or question mark (?) as a wildcard. Click the **Go** icon or press **Enter** on your keyboard.
5. The results of your search appear in the list in the left pane. To dismiss the search and return to the complete list of attributes, click the **Clear search text** icon.

Adding an Index to a New Attribute by Using Oracle Directory Services Manager

To add an index to an attribute:

1. Create an attribute as described in "[Adding a New Attribute by Using Oracle Directory Services Manager](#)" on page 20-13 or in "[Adding and Modifying Attributes by Using ldapmodify](#)" on page 20-19
2. In the New Attribute Type dialog box, select the **Indexed** box.

Adding an Index to an Existing Attribute by Using Oracle Directory Services Manager

You can use Oracle Directory Services Manager to add an index to an existing attribute only if that attribute is not in use yet.

To add an index to an existing attribute:

1. Invoke Oracle Directory Services Manager and connect to the Oracle Internet Directory server as described in "[Invoking Oracle Directory Services Manager](#)" on page 7-9.

2. From the task selection bar, select **Schema**.
3. Select an attribute that is not currently indexed that you want to add the index to.
4. Click the **The attribute will be cataloged/decataloged** icon. When the Confirm Dialog appears, click **Confirm**.
5. The Indexed box indicates that the attribute is indexed.

Dropping an Index from an Attribute by Using Oracle Directory Services Manager

To drop an index from an attribute:

1. Invoke Oracle Directory Services Manager and connect to the Oracle Internet Directory server as described in "[Invoking Oracle Directory Services Manager](#)" on page 7-9.
2. From the task selection bar, select **Schema**.
3. Select an attribute that is currently indexed that you want to drop the index from.
4. Click the **The attribute will be cataloged/decataloged** icon. When the Confirm Dialog appears, click **Confirm**.
5. The Indexed box indicates that the attribute is no longer indexed.

Creating a Content Rule by Using Oracle Directory Services Manager

To create a content rule:

1. Invoke Oracle Directory Services Manager and connect to the Oracle Internet Directory server as described in "[Invoking Oracle Directory Services Manager](#)" on page 7-9.
2. From the task selection bar, choose **Schema**.
3. In the left pane, expand the **Content Rules** list.
4. Choose **Create**. The New Content Rule dialog box appears.
5. In the New Content Rule dialog box, add information in the **Structural Object Class** and **Object ID** fields. Optionally, add a label.

Choose the **Add**, **Delete**, or **Edit** icons in the toolbar above the **Auxiliary Classes**, **Mandatory Attributes**, or **Optional Attributes** list to add or delete an item. When adding, select the auxiliary class, mandatory attribute or optional attribute from the dialog. Use the search function if necessary.

6. Alternatively, in the **Content Rules** panel, select a content rule that is similar to one you would like to create, and then choose **Create Like**. The New Content Rule dialog box displays the attributes of the selected content rule. You can create the new content rule by using this one as a template.
7. Choose **OK** to add the content rule.

Modifying a Content Rule by Using Oracle Directory Services Manager

To modify a content rule:

1. Invoke Oracle Directory Services Manager and connect to the Oracle Internet Directory server as described in "[Invoking Oracle Directory Services Manager](#)" on page 7-9.
2. From the task selection bar, choose **Schema**.

3. In the left pane, expand the **Content Rules** list.
4. Select the content rule you want to modify. You can search for a content rule by entering a keyword in the search field, in the same way you search for object classes. See "[Searching for Object Classes by Using Oracle Directory Services Manager](#)" on page 20-11.

5. Modify values in the appropriate fields in the content rule tab.

Choose the **Add**, **Delete**, or **Edit** icons in the toolbar above the **Auxiliary Classes**, **Mandatory Attributes**, or **Optional Attributes** list to add or delete an item. When adding, select the auxiliary class, mandatory attribute or optional attribute from the dialog. Use the search function if necessary

6. Choose **Apply** to make the changes effective or choose **Revert** to abandon the changes.

Viewing Matching Rules by Using Oracle Directory Services Manager

Note: Matching rules cannot be modified.

1. Invoke Oracle Directory Services Manager and connect to the Oracle Internet Directory server as described in "[Invoking Oracle Directory Services Manager](#)" on page 7-9.
2. From the task selection bar, choose **Schema**.
3. Expand the **Matching Rules** list. Matching rules are shown in the list.
4. You can search for a matching rule by entering a keyword in the search field, in the same way you search for object classes. See "[Searching for Object Classes by Using Oracle Directory Services Manager](#)" on page 20-11.
5. Select a matching rule to see its details in the matching rule tab page on the right.

Viewing Syntaxes by Using Oracle Directory Services Manager

Note: Syntaxes cannot be modified.

To view syntaxes by using Oracle Directory Services Manager:

1. Invoke Oracle Directory Services Manager and connect to the Oracle Internet Directory server as described in "[Invoking Oracle Directory Services Manager](#)" on page 7-9.
2. From the task selection bar, choose **Schema**.
3. Expand the **Syntaxes** list. Syntax names are shown in the list.
4. Select a syntax to see its details in the syntax tab page on the right.

Managing Directory Schema by Using the Command Line

This section contains the following topics:

- [Viewing the Schema by Using ldapsearch](#)
- [Adding a New Object Class by Using Command-Line Tools](#)

- [Adding a New Attribute to an Auxiliary or User-Defined Object Class by Using Command-Line Tools](#)
- [Modifying Object Classes by Using Command-Line Tools](#)
- [Adding and Modifying Attributes by Using ldapmodify](#)
- [Deleting Attributes by Using ldapmodify](#)
- [Indexing an Attribute for Which No Data Exists by Using ldapmodify](#)
- [Dropping an Index from an Attribute by Using ldapmodify](#)
- [Indexing an Attribute for Which Data Exists by Using the Catalog Management Tool](#)
- [Adding a New Attribute With Attribute Aliases by Using the Command Line](#)
- [Adding or Modifying Attribute Aliases in Existing Attributes by Using the Command Line](#)
- [Deleting Attribute Aliases by Using the Command Line](#)
- [Using Attribute Aliases with LDAP Commands](#)
- [Managing Content Rules by Using Command-Line Tools](#)
- [Viewing Matching Rules by Using ldapsearch](#)
- [Viewing Syntaxes by Using ldapsearch](#)

Viewing the Schema by Using ldapsearch

You can write the schema to a file by typing:

```
ldapsearch -h OID_host -p OID_port -q -L -D "cn=orcladmin" \
    -b "cn=subschemasubentry" -s base "objectclass=*" > schema.ldif
```

Adding a New Object Class by Using Command-Line Tools

In this example, an LDIF input file, `new_object_class.ldif`, contains data similar to this:

```
dn: cn=subschemasubentry
changetype: modify
add: objectclasses
objectclasses: ( 2.16.840.1.113894.9999.12345 NAME 'myobjclass' SUP top STRUCTURAL
MUST ( cn $ sn )
MAY ( telephonenumber $ givenname $ myattr ) )
```

Be sure to leave the mandatory space between the opening and closing parentheses and the object identifier.

To load the file, enter this command:

```
ldapmodify -D "cn=orcladmin" -q -h myhost -p 3060 -f new_object_class.ldif
```

This example:

- Adds the *structural* object class named `myobjclass`
- Gives it an object identifier of `2.16.840.1.113894.9999.12345`.
- Specifies `top` as its superclass
- Specifies `cn` and `sn` as mandatory attributes

- Allows `telephonenumber`, `givenname`, and `myattr` as optional attributes

Note that all the attributes mentioned must exist before the execution of the command.

To create an *abstract* object class, follow the previous example, replacing the word `STRUCTURAL` with the word `ABSTRACT`.

Adding a New Attribute to an Auxiliary or User-Defined Object Class by Using Command-Line Tools

To add a new attribute to either an auxiliary object class or a user-defined structural object class, use `ldapmodify`. This example deletes the old object class definition and adds the new definition in a compound modify operation. The change is committed by the directory server in one transaction. Existing data is not affected. The input file should be as follows:

```
dn: cn=subschemasubentry
changetype: modify
delete: objectclasses
objectclasses: old value
-
add: objectclasses
objectclasses: new value
```

For example, to add the attribute changes to the existing object class `country`, the input file would be:

```
dn: cn=subschemasubentry
changetype: modify
delete: objectclasses
objectclasses:
( 2.16.840.1.113894.9999.12345 NAME 'country' SUP top STRUCTURAL MUST c MAY
  ( searchGuide $ description ) )
-
add: objectclasses
objectclasses:
( 2.16.840.1.113894.9999.12345 NAME 'country' SUP top STRUCTURAL MUST c MAY
  ( searchGuide $ description $ changes ) )
```

To load the file, enter this command:

```
ldapmodify -D "cn=orcladmin" -q -h myhost -p 3060 -f new_attribute.ldif
```

Modifying Object Classes by Using Command-Line Tools

To add or modify schema components, use `ldapmodify`.

See Also: The `ldapmodify` command-line tool reference in *Oracle Fusion Middleware Reference for Oracle Identity Management*

Adding and Modifying Attributes by Using `ldapmodify`

To add a new attribute to the schema by using `ldapmodify`, type a command similar to the following at the system prompt:

```
ldapmodify -D "cn=orcladmin" -q -h host -p port -f ldif_file_name
```

The LDIF file contains data similar to this:

```
dn: cn=subschemasubentry
```

```
changetype: modify
add: attributetypes
attributetypes: ( 1.2.3.4.5 NAME 'myattr' SYNTAX
                  '1.3.6.1.4.1.1466.115.121.1.38' )
```

To specify an attribute as single-valued, include in the attribute definition entry in the LDIF file the keyword SINGLE-VALUE with surrounding white space.

You can find a given syntax Object ID by using either Oracle Directory Services Manager or the ldapsearch command line tool.

See Also:

- The `ldapmodify` command-line tool reference in *Oracle Fusion Middleware Reference for Oracle Identity Management* for a detailed explanation of `ldapmodify` and its options
- ["Viewing Syntaxes by Using by Using ldapsearch"](#) on page 20-26 for instructions on how to view syntaxes by using either Oracle Directory Services Manager or `ldapsearch`

Deleting Attributes by Using ldapmodify

Note: You can delete only user-defined attributes. Do not delete attributes from the base schema.

To delete an attribute by using `ldapmodify`, type a command similar to the following at the system prompt:

```
ldapmodify -D "cn=orcladmin" -q -h host -p port -f ldif_file_name
```

The LDIF file contains data similar to this:

```
dn: cn=subschemasubentry
changetype: modify
delete: attributetypes
attributetypes: ( 1.2.3.4.5 NAME 'myattr' SYNTAX
                  '1.3.6.1.4.1.1466.115.121.1.38' )
```

You can find a given syntax Object ID by using either Oracle Directory Services Manager or the ldapsearch command line tool.

See Also:

- The `ldapmodify` command-line tool reference in *Oracle Fusion Middleware Reference for Oracle Identity Management* for a detailed explanation of `ldapmodify` and its options
- ["Viewing Syntaxes by Using by Using ldapsearch"](#) on page 20-26 or ["Viewing Syntaxes by Using Oracle Directory Services Manager"](#) on page 20-17 for instructions on how to view syntaxes

Indexing an Attribute for Which No Data Exists by Using ldapmodify

After you define a new attribute in the schema, you can add it to the catalog entry by using `ldapmodify`.

To add an attribute for which no directory data exists, import an LDIF file by using `ldapmodify`. For example, to add a new attribute `foo` that has already been defined in the schema, import the following LDIF file by using `ldapmodify`:

```
dn: cn=catalogs
changetype: modify
add: orclindexedattribute
orclindexedattribute: foo
```

Type a command similar to the following at the system prompt:

```
ldapmodify -D "cn=orcladmin" -q -h host -p port -f ldif_file_name
```

You should not use this method to index an attribute for which data exists in the directory. To index such an attribute, use the Catalog Management tool, `catalog`. See ["Creating and Dropping Indexes from Existing Attributes by Using catalog"](#) on page 15-11.

Dropping an Index from an Attribute by Using `ldapmodify`

To drop an index from an attribute by using `ldapmodify`, specify `delete` in the LDIF file. For example:

```
dn: cn=catalogs
changetype: modify
delete: orclindexedattribute
orclindexedattribute: foo
```

See Also: The `ldapmodify` command-line tool reference in *Oracle Fusion Middleware Reference for Oracle Identity Management*

Indexing an Attribute for Which Data Exists by Using the Catalog Management Tool

Use the Catalog Management tool to index an attribute for which data already exists and to drop an index from an attribute. See ["Creating and Dropping Indexes from Existing Attributes by Using catalog"](#) on page 15-11.

See Also: The `catalog` command-line tool reference in *Oracle Fusion Middleware Reference for Oracle Identity Management*

Note: Unless you are absolutely sure that the indexes were not created by the base schema that was installed with Oracle Internet Directory, be careful not to use the `catalog delete=T` option to remove indexes from attributes. Removing indexes from base schema attributes can adversely impact the operation of Oracle Internet Directory.

Adding a New Attribute With Attribute Aliases by Using the Command Line

You add, modify, or delete attribute aliases by creating an LDIF file, then using `ldapmodify` with the following syntax:

```
ldapmodify -D "cn=orcladmin" -q -h host -p port -f ldif_file_name
```

Note: DN is not an attribute. You cannot define `dn` in the schema. Therefore you cannot create an alias for `dn`.

The following LDIF file adds the attribute `myattr` with the attribute aliases `myalias1` and `myalias2`:

```
dn: cn=subschemasubentry
changetype: modify
add: attributeTypes
attributeTypes: ( 1.2.3.4.5 NAME ( 'myattr' 'myalias1' 'myalias2' ) SYNTAX
                 '1.3.6.1.4.1.1466.115.121.1.38' )
```

Adding or Modifying Attribute Aliases in Existing Attributes by Using the Command Line

The following LDIF file adds the attribute aliases `surname` and `mysurName` to the existing attribute `sn`:

```
dn: cn=subschemasubentry
changetype: modify
delete: attributeTypes
attributeTypes: ( 2.5.4.4 NAME 'sn' SUP name )
-
add: attributeTypes
attributeTypes: ( 2.5.4.4 NAME ( 'sn' 'surname' 'mysurName' ) SUP name )
```

Type a command similar to the following at the system prompt:

```
ldapmodify -D "cn=orcladmin" -q -h host -p port -f ldif_file_name
```

Deleting Attribute Aliases by Using the Command Line

Use the `ldapmodify` command to delete attribute aliases. The following LDIF file deletes the attribute alias `mysurName` but not the attribute alias `surName` from the attribute `sn`:

```
dn: cn=subschemasubentry
changetype: modify
delete: attributeTypes
attributeTypes: ( 2.5.4.4 NAME ( 'sn' 'surname' 'mysurName' ) SUP name )
-
add: attributeTypes
attributeTypes: ( 2.5.4.4 NAME ( 'sn' 'surname' ) SUP name )
```

The following LDIF file deletes both attribute aliases, `surname` and `mysurName`, from the attribute `sn`:

```
dn: cn=subschemasubentry
changetype: modify
delete: attributeTypes
attributeTypes: ( 2.5.4.4 NAME ( 'sn' 'surname' 'mysurName' ) SUP name )
-
add: attributeTypes
attributeTypes: ( 2.5.4.4 NAME 'sn' SUP name )
```

Using Attribute Aliases with LDAP Commands

After you define attribute aliases in the LDAP schema, users can substitute the aliases for attribute names in LDAP operations. The following examples show the commands to use and the results to expect:

- [Using Attribute Aliases with ldapsearch](#)

- [Using Attribute Aliases with ldapadd](#)
- [Using Attribute Aliases with ldapmodify](#)
- [Using Attribute Aliases with ldapdelete](#)
- [Using Attribute Aliases with ldapmoddn](#)

Table 20–1 shows the aliases used in the examples and the attributes names they represent:

Table 20–1 Attribute Aliases Used in Examples

Alias	Attribute Name
userid	uid
organizationalunit	ou
country	c
organization	o
surname	sn
commonname	cn
phone	telephonenumber

Using Attribute Aliases with ldapsearch

The LDAP server recognizes attribute aliases in the search filter string, in the base DN, and in the required attributes list in `ldapsearch` operations. The search result contains the actual attribute names, unless the user explicitly asks for an alias using the required attributes list. For example, suppose the user specifies the following search, using the aliases `organizationalUnit`, `country`, and `organization` in the base DN and the alias `surname` in the filter string:

```
ldapsearch -p 3060 -h myhost \
  -b "organizationalUnit=dev,country=us,organization=myorg" \
  -s sub "surname=brown"
```

The search returns a result similar to this:

```
uid=mbrown,ou=dev,c=us,o=myorg
uid=mbrown
sn=Brown
cn=Mark Brown
telephonenumber;office=444006
telephonenumber;mobile=555006
objectclass=organizationalPerson
objectclass=top
objectclass=person
```

Now suppose the user specifically asks for the aliases `surname`, `commonname`, and `userid` by including them in a required attributes list, like this:

```
ldapsearch -p 3060 -h myhost \
  -b "organizationalUnit=dev,country=us,organization=myorg" \
  -s sub "surname=brown" surname commonname userid phone
```

Because the user specifically included the aliases, the search returns a result similar to this:

```
uid=mbrown,ou=dev,c=us,o=myorg
surname=Brown
```

```

commonname=Mark Brown
userid=mbrown
phone;office=444006
phone;mobile=555006
    
```

Using Attribute Aliases with Idapadd

The LDAP server recognizes attribute aliases in place of attribute names during the add operation. When the LDAP server stores the entry, it replaces the alias with the actual attribute name.

The command-line format is:

```
ldapadd -h host -p port -D cn=orcladmin -q -f ldif_file_name
```

The user could provide an LDIF file like this:

```

dn: userid=mbrown,organizationalUnit=dev,country=us,organization=myorg
objectclass: account
objectclass: organizationalPerson
userID: mbrown
surname: Brown
commonName: Mark Brown
userpassword: password
phone;office: 444006
phone;mobile: 555006
    
```

The entry is stored as if the file contained the attribute names instead of the aliases. On subsequent LDAP searches, however, the DN is returned as it was entered when added or modified:

```
dn: userid=mbrown,organizationalUnit=dev,country=us,organization=myorg
```

This is standard behavior for LDAP search results. The DN is always returned with the same format that was used when the entry was created.

Using Attribute Aliases with Idapmodify

The LDAP server recognizes attribute aliases in place of attribute names during the modify operation.

The command-line format is:

```
ldapmodify -D "cn=orcladmin" -q -h host -p port -f ldif_file_name
```

The user could provide an LDIF file like this:

```

dn:
userid=mbrown,organizationalUnit=dev,country=us,organization=myorg
changetype: modify
replace: surname
surname: davis
    
```

The entry is stored as if the file contained the attribute names instead of the aliases. On subsequent LDAP searches, however, the DN is returned as it was entered when added or modified:

```
dn: userid=mbrown,organizationalUnit=dev,country=us,organization=myorg
```

This is standard behavior for LDAP search results. The DN is always returned with the same format that was used when the entry was created.

Using Attribute Aliases with `ldapdelete`

The LDAP server recognizes attribute aliases in the DN provided for delete operations. For example, suppose the user provides a request like this, with the aliases `userid`, `organizationalUnit`, `country`, and `organization` in the search filter:

```
ldapdelete -D "cn=orcladmin" -q -p 3060 \
-h myhost "userid=mbrown,organizationalUnit=dev,country=us,organization=myorg"
```

The server deletes the entry as if the user had typed:

```
ldapdelete -D "cn=orcladmin" -q -p 3060 \
-h myhost "uid=mbrown,ou=dev,c=us,o=myorg"
```

Using Attribute Aliases with `ldapmoddn`

The LDAP server recognizes attribute aliases in the DN, the new RDN, and the new parent DN options. For example, suppose the user types the command line:

```
ldapmoddn -D "cn=orcladmin" -q \
-b "userid=mbrown,organizationalUnit=dev,country=us,organization=myorg" \
-R "userid=mdavis"
```

The LDAP server interprets the command line as if the user had typed

```
ldapmoddn -D "cn=orcladmin" -q -b "uid=mbrown,ou=dev,c=us,o=myorg" \
-R "uid=mdavis"
```

The entry is stored as if the file contained the attribute names instead of the aliases. On subsequent LDAP searches, however, the DN is returned as it was entered when added or modified:

```
dn: userid=mbrown,organizationalUnit=dev,country=us,organization=myorg
```

This is standard behavior for LDAP search results. The DN is always returned with the same format that was used when the entry was created.

Managing Content Rules by Using Command-Line Tools

The format of a content rule is:

```
DITContentRule ::= SEQUENCE {
oids                ALPHA-NUMERIC-OID,
structuralObjectClass OBJECT-CLASS,
LABEL              CONTENT-LABEL OPTIONAL,
auxiliaries        SET (1..MAX) OF OBJECT-CLASS OPTIONAL,
mandatory          SET (1..MAX) OF ATTRIBUTE OPTIONAL,
optional           SET (1..MAX) OF ATTRIBUTE OPTIONAL,
precluded          SET (1..MAX) OF ATTRIBUTE OPTIONAL
}
```

You can use `ldapmodify` with an LDIF file such as the following to add a content rule:

```
dn: cn=subschemasubentry
changetype: modify
add: contentrules
contentrules: ( 2.16.840.1.113894.9999.1.1 OBJECTCLASS 'exampleObjClassName'
LABEL abc AUX exampleAuxObjClassName MUST businessCategory MAY ( description $
host ) )
```

Table 20–2 describes the parameters. Note that the attribute and object class names are case-insensitive.

Table 20–2 Content Rule Parameters

Parameter	Description
oids	A unique object identifier (oids) for the content rule similar to the one for an object class or attribute definition. It must be a unique numeric value that begins with 2.16.840.1.113894 followed by .9999 or a site-specific prefix.
LABEL	The content label of the content rule as applied in the directory
structuralObjectClass	The structural object class to which the content rule applies
auxiliaries	The auxiliary object classes allowed for an entry to which the content rule applies
mandatory	User attribute types contained in an entry to which the content rule applies. These are in addition to those mandatory attributes that the entry contains as a result of its association with its specified structural and auxiliary object classes.
optional	User attribute types that may be contained in an entry to which the content rule applies. These are in addition to those that the entry may contain as a result of its association with its specified structural and auxiliary object classes.

Viewing Matching Rules by Using ldapsearch

Note: Matching rules cannot be modified.

To view matching rules, type:

```
ldapsearch -L -D "cn=orcladmin" -p port -q -b "cn=subschemasubentry" -s base
"objectclass=*" matchingrules
```

See Also: The `ldapsearch` command-line tool reference in *Oracle Fusion Middleware Reference for Oracle Identity Management*

Viewing Syntaxes by Using ldapsearch

Note: Syntaxes cannot be modified.

To view syntaxes, type:

```
ldapsearch -L -D "cn=orcladmin" -p port -q -b "cn=subschemasubentry" -s base
"objectclass=*" ldapsyntaxes
```

See Also: The `ldapsearch` command-line tool reference in *Oracle Fusion Middleware Reference for Oracle Identity Management*

Configuring Referential Integrity

This chapter contains the following topics:

- [Introduction to Configuring Referential Integrity](#)
- [Enabling Referential Integrity by Using Fusion Middleware Control](#)
- [Disabling Referential Integrity by Using Fusion Middleware Control](#)
- [Enabling Referential Integrity by Using the Command Line](#)
- [Configuring Specific Attributes for Referential Integrity by Using the Command Line](#)
- [Disabling Referential Integrity by Using the Command Line](#)
- [Detecting and Correcting Referential Integrity Violations](#)

Introduction to Configuring Referential Integrity

Referential integrity is the process of maintaining consistent relationships among sets of data. If referential integrity is enabled in Oracle Internet Directory, whenever you update an entry in the directory, the server also updates other entries that refer to that entry. For example, if you remove a user's entry from the directory, and the user is a member of a group, the server also removes the user from the group. If referential integrity is not enabled, the user remains a member of the group until manually removed. Referential integrity is not enabled by default.

Note: Disable referential integrity during the replication bootstrapping process. If referential integrity is enabled, bootstrapping fails.

Referential integrity takes effect in two situations:

- **Delete**—When an entry is deleted, all the DN attributes that refer to this entry DN are removed.
- **Modify**—When an entry's DN is modified (renamed), all the attributes that refer to this entry DN are modified.

Beginning with 11g Release 1 (11.1.1), the Oracle Internet Directory server can enforce referential integrity. For every LDAP add, modify, delete, and rename operation, the server monitors the request and updates the necessary DN references.

Two configuration parameters control referential integrity: `orclRIenabled` and `orclRIattr`.

- The parameter `orclRIenabled` controls the referential integrity level. Values for `orclRIenabled` are:
 - 0—Referential integrity is disabled
 - 1—Referential integrity is enabled for `member` and `uniquemember` attributes only.
 - 2—Referential Integrity is enabled for a list of DN syntax attributes as specified in `orclRIattr` and for attributes `member` and `uniquemember`.
- When `orclRIenabled` is set to 2, the value of the parameter `orclRIattr` takes effect. The value of `orclRIattr` is a list of referential integrity-enabled attributes.

If referential integrity is enabled, it is strictly enforced. For example, you cannot add a group entry whose `member` or `uniquemember` attributes are not currently part of the DIT.

Enabling Referential Integrity by Using Fusion Middleware Control

To configure and enable referential integrity by using Oracle Enterprise Manager Fusion Middleware Control, perform the following steps:

1. Select **Administration**, then **Shared Properties** from the **Oracle Internet Directory** menu, then select **General**.
2. Select a value from the Referential Integrity list:
 - Enabled for `GroupofNames` and `GroupofUniqueNames`
 - Enabled for `GroupofNames`, `GroupofUniqueNames`, and configured DN attributes
3. Choose **Apply**.

Disabling Referential Integrity by Using Fusion Middleware Control

To disable referential integrity by using Oracle Enterprise Manager Fusion Middleware Control, perform the following steps:

1. Select **Administration**, then **Shared Properties** from the **Oracle Internet Directory** menu, then select **General**.
2. Select **Disabled** from the Enable Referential Integrity list.

Enabling Referential Integrity by Using the Command Line

You enable referential integrity in the directory by using `ldapmodify` to change the value of the parameter `orclRIenabled` in the DSA Configuration entry:

```
cn=dsaconfig,cn=configsets,cn=oracle internet directory.
```

You can set the value to either 1 or 2.

Setting a value of 1 enables referential integrity for `GroupofNames` and `GroupofUniqueNames`.

Setting a value of 2 for `orclRIenabled` enables referential integrity for `GroupofNames` and `GroupofUniqueNames` and for specific configured attributes. The next section describes configuring specific attributes.

For example, you would use a command line such as:

```
ldapmodify -D cn=orcladmin -q -p portNum -h hostname -f ldifFile
```

with an LDIF file such as:

```
dn: cn=dsaconfig, cn=configsets, cn=oracle internet directory
changetype: modify
replace: orclRIenabled
orclRIenabled: 2
```

Changes to `orclRIenabled` take effect immediately.

Configuring Specific Attributes for Referential Integrity by Using the Command Line

When `orclRIenabled` is set to 2, referential integrity is enabled for `GroupofNames`, `GroupofUniqueNames`, and for specific configured attributes.

You configure specific attributes for referential integrity by using `catalog` with the arguments `rienable=TRUE`, `add=true`, and `attribute=name_of_attribute`. This adds the attribute to `orclRIattr`, which contains the list of DN syntax attributes to which referential integrity applies. You remove an attribute from referential integrity by using `catalog` with the arguments `rienable=TRUE`, `delete=true`, and `attribute=name_of_attribute`. This removes the attribute from `orclRIattr`.

Notes:

- You cannot change the value of `orclRIattr` by using `ldapmodify`. You must use the `catalog` command.
 - Remember that the `ORACLE_INSTANCE` environment variable must be set when you use `catalog`.
-
-

This example enables referential integrity for the attribute manager.

```
catalog connect="connect_str" add=true riable="TRUE" attribute="manager"
```

This example disables referential integrity for the attribute manager.

```
catalog connect="connect_str" delete=true riable="TRUE" attribute="manager"
```

Disabling Referential Integrity by Using the Command Line

To disable referential integrity in the directory, set the value of `orclRIenabled` to 0 in the DSA Configuration entry:

```
cn=dsaconfig, cn=configsets, cn=oracle internet directory.
```

Detecting and Correcting Referential Integrity Violations

When you try to enable referential integrity, if there are underlying violations in the DIT, you get an error. You must run the `oiddiag` tool to look at the violations, rectify them, and then enable referential integrity. The `oiddiag` tool has an option, `OidDiagDC10`, to report all the referential integrity violations. in LDIF format. That LDIF file can be used with `ldapmodify` tool to fix all reported entries. The steps are as follows:

1. Run `oiddiag` with the option `listdiags=true`. The default output file is `ORACLE_INSTANCE/diagnostics/logs/OID/tools/oiddiag.txt`.
2. Edit the output file, `oiddiag.txt` so that it contains only the line:
`oracle.ldap.oiddiag.dc.OidDiagDC10`
3. Run `oiddiag` with the option `collect_sub=true`

See Also:

- The `oiddiag` command reference in *Oracle Fusion Middleware Reference for Oracle Identity Management*.
- The `oiddiag` usage message. Type:
`oiddiag -help`

Note: On Windows, the filename of the `oiddiag` command is `oiddiag.bat`.

Managing Auditing

This chapter covers only Oracle Internet Directory-specific information. See *Oracle Fusion Middleware Application Security Guide* for complete coverage of Audit Administration Tasks.

This chapter contains the following topics:

- [Introduction to Auditing](#)
- [Managing Auditing by Using Fusion Middleware Control](#)
- [Managing Auditing by Using WLST](#)
- [Managing Auditing from the Command Line](#)

Introduction to Auditing

This introduction contains the following topics:

- [Configuring the Audit Store](#)
- [Oracle Internet Directory Audit Configuration](#)
- [Replication and Oracle Directory Integration Platform Audit Configuration](#)
- [Audit Record Fields](#)
- [Audit Record Storage](#)
- [Generating Audit Reports](#)

Auditing is the process that collects and stores information about security requests and the outcome of those requests, thus providing an electronic trail of selected system activity for non-repudiation purposes. Auditing can be configured to track particular security events and management operations based on specific audit criteria. Audit records are kept in a centralized repository (LDAP, database, or file) that allows the creation, viewing, and storage of audit reports.

As of release 11g Release 1 (11.1.1), Oracle Internet Directory uses an audit framework that is integrated with Oracle Fusion Middleware. Oracle Internet Directory uses this framework to audit its critical security related operations. The features of the framework are:

- APIs for collecting audit information from AS components
- Common audit record format to be used by all AS components
- Audit repository database that collects audit records produced by components in the enterprise. (The customer also has an option to use the Audit vault as a repository)

- Administrative interface for controlling the type of information captured by the audit facility.

Before reading this chapter, please read the auditing chapters in the *Oracle Fusion Middleware Application Security Guide*.

The new Oracle Internet Directory audit framework has the following advantages:

- It uses the same record format as other Oracle Application Server components.
- Records are stored in Oracle Database tables for better performance and security.
- Records can be stored in Audit Vault for increased security.
- As administrator, you can configure the type of information captured in the audit records by using Enterprise Manager.
- Configuration changes are effective immediately.
- An administrator can view audit records:
 - In Enterprise Manager
 - In summary reports based on XML Publisher

All audit configuration performed by the instance administrator is audited. This cannot be disabled.

See Also: *Oracle Fusion Middleware Application Security Guide* for information about configuring the audit repository and audit filters.

Configuring the Audit Store

You must configure an audit store to ensure that audit records are saved in a database. See the "Configuring and Managing Auditing" chapter in *Oracle Fusion Middleware Application Security Guide* for complete coverage of Audit Administration Tasks, including:

- Managing the Audit Store
- Advanced Management of Database Store

Oracle Internet Directory Audit Configuration

Audit configuration for Oracle Internet Directory consists of three attributes of the instance-specific entry:

`cn=componentname,cn=osdldapd,cn=subconfigsentry`

Table 22–1 describes these attributes.

Table 22–1 Oracle Internet Directory Audit Configuration Attributes

Attribute	Description
<code>orclAudFilterPreset</code>	Presets are None, Low, Medium, All, and Custom, where Low specifies Account Management, Change Password and ModifyDataItemAttributes events and Medium specifies all events in Low plus Failed authentication events.

Table 22–1 (Cont.) Oracle Internet Directory Audit Configuration Attributes

Attribute	Description
<code>orclAudCustEvents</code>	A comma-separated list of events and category names to be audited. Examples include: Authentication.SUCSESSESONLY, Authorization(Permission -eq 'CSFPerfmission') Custom events are only applicable when <code>orclAudFilterPreset</code> is Custom.
<code>orclAudSplUsers</code>	A comma separated list of users for whom auditing is always enabled, even if <code>orclAudFilterPreset</code> is None. For example: <code>cn=orcladmin.</code>

For more information, see the *Oracle Fusion Middleware Application Security Guide*.

Replication and Oracle Directory Integration Platform Audit Configuration

Replication and Oracle Directory Integration Platform auditing can be enabled by changing the value of the attribute `orclExtConfFlag` in the instance-specific configuration entry. The default value is 3, which disables both replication and Oracle Directory Integration Platform auditing. To enable both, change it to 7. This is the only change you can make to `orclExtConfFlag`, which is otherwise an internal attribute.

See ["Enabling Replication and Oracle Directory Integration Platform Auditing"](#) on page 22-6.

Audit Record Fields

Audit records contain the following fields:

- Event category—the class of event, such as authentication or authorization.
- Event name
- Initiator—the user who initiates the operation
- Status—success or failure
- Authentication method
- Session ID—Connection ID
- Target—the user on whom the operation is performed
- Event date and time
- Remote IP—source IP address of client
- Component type—OID
- ECID
- Resource—entry or attribute on which operation is performed.

Audit Record Storage

Audit information is held temporarily in a location called a busstop before it is written to its final location.

The file is in the directory `ORACLE_
INSTANCE/auditlogs/componentType/componentName.`

Audit files are permanently stored in either XML files or a database. XML files are the default storage mechanism for audit records. There is one XML repository for each Oracle instance. Audit records generated for all components running in a given Oracle instance are stored in the same repository. If using a database repository, audit records generated by all components in all Oracle instances in the domain are stored in the same repository.

Generating Audit Reports

See the *Oracle Fusion Middleware Application Security Guide* chapter on audit analysis and reporting for information about generating audit reports.

Managing Auditing by Using Fusion Middleware Control

You can use Oracle Enterprise Manager Fusion Middleware Control to manage auditing. The interface is basically the same for all Oracle Fusion Middleware components, as documented in the *Oracle Fusion Middleware Application Security Guide*.

1. From the Oracle Internet Directory menu, select **Security**, then **Audit Policy Settings**.
2. From the Audit Policy list, select **Custom** to configure your own filters, or one of the filter presets, **None**, **Low**, or **Medium**. (You cannot set All from Fusion Middleware Control.)
3. If you want to audit only failures, click Select Failures Only.
4. To configure a filter, click the **Edit** icon next to its name. The Edit Filter dialog for the filter appears.
5. Specify the filter condition using the buttons, selections from the menus, and strings that you enter. Condition subjects include HostID, HostNwaddr, InitiatorDN, TargetDN, Initiator, Remote IP, and Roles. Condition tests include -contains, -contains_case, endswith, endswith_case, -eq, -ne, -startswith, and -startswith-case. Enter values for the tests as strings. Parentheses are used for grouping and AND and OR for combining.
6. To add a condition, click the **Add** icon.
7. When you have completed the filter, click **Apply** to save the changes or **Revert** to discard the changes.

Oracle Internet Directory stores its audit configuration in the three instance-specific configuration entry attributes described in [Table 22-1, "Oracle Internet Directory Audit Configuration Attributes"](#). The correspondence between the fields on the Audit Policy Page and the attributes is shown in [Table 22-2](#).

Table 22-2 Audit Configuration Attributes in Fusion Middleware Control

Field or Heading	Configuration attribute
Audit Policy	orclAudFilterPreset
Name, Select Failures Only, Enable Audit, Filter	orclAudCustEvents
Users to always audit	orclAudSplUsers

Managing Auditing by Using WLST

You can use `wlst` to manage auditing, as described in "Manage Audit Policies with WLST" in the *Oracle Fusion Middleware Application Security Guide*. You use the commands `getAuditPolicy()`, `setAuditPolicy()`, or `listAuditEvents()`.

For component that manage their audit policy locally, such as Oracle Internet Directory, you must include an MBean name as an argument to the command. The name for an Audit MBean is of the form:

```
oracle.as.management.mbeans.register:type=component.auditconfig,name=auditconfig1,instance=INSTANCE,component=COMPONENT_NAME
```

For example:

```
oracle.as.management.mbeans.register:type=component.auditconfig,name=auditconfig1,instance=instance1,component=oid1
```

Another `wlst` command you must use is `invoke()`. As described in "[Managing System Configuration Attributes by Using WLST](#)" on page 9-14, before you make any changes to attributes, you must ensure that the MBean has the current server configuration. To do that, you must use the `invoke()` command to load the configuration from Oracle Internet Directory server to the mbean. After making changes, you must use the `invoke()` command to save the MBean configuration to the Oracle Internet Directory server. In order to use `invoke()` in this way, you must navigate to the Root Proxy MBean in the tree. The name for a Root Proxy MBean is of the form:

```
oracle.as.management.mbeans.register:type=component,name=COMPONENT_NAME,instance=INSTANCE
```

For example:

```
oracle.as.management.mbeans.register:type=component,name=oid1,instance=instance1
```

Here is an example of a `wlst` session using `setAuditPolicy()` and `invoke()`:

```
ORACLE_COMMON_HOME/common/bin/wlst.sh
connect('username', 'password', 'localhost:7001')
custom()
cd('oracle.as.management.mbeans.register')
cd('oracle.as.management.mbeans.register:type=component,name=oid1,instance=instance1')
invoke('load',jarray.array([],java.lang.Object),jarray.array([],java.lang.String))
setAuditPolicy(filterPreset='None',
  on='oracle.as.management.mbeans.register:type=component.auditconfig,
  name=auditconfig1,instance=instance1,component=oid1')
invoke('save',jarray.array([],java.lang.Object),jarray.array([],java.lang.String))
```

Managing Auditing from the Command Line

You can manage auditing by using LDAP tools.

Viewing Audit Configuration from the Command Line

You can use `ldapsearch` to view audit configuration. For example:

```
ldapsearch -p 3060 -h myhost.example.com -D cn=orcladmin -q \
  -b "cn=oid1,cn=osdldapd,cn=subconfigsentry" \
  -s base "objectclass=*" > /tmp/oid1-config.txt
grep orclaud oid1-config.txt
```

```
orclaudsplusers=cn=orcladmin
orclaudcustevents=UserLogin.FAILUREONLY, UserLogout, CheckAuthorization,
  ModifyDataItemAttributes, CompareDataItemAttributes, ChangePassword.FAILUREONLY
orclaudfilterpreset=custom
```

Configuring Oracle Internet Directory Auditing from the Command Line

You can use `ldapmodify` commands to manage auditing. You must create an LDIF file to make the required changes to the attributes `orclAudFilterPreset`, `orclAudCustEvents`, and `orclAudSplUsers`.

The command is:

```
ldapmodify -D cn=orcladmin -q -p portNum -h hostname -f ldifFile
```

For example to enable auditing for user login events only, use this LDIF file with the preceding `ldapmodify` command:

```
dn: cn=componentname,cn=osldapd,cn=subconfigsubentry
changetype: modify
replace: orclaudFilterPreset
orclaudFilterPreset: Custom
-
replace: orclaudcustevents
orclaudcustevents: UserLogin
```

For more information, see the *Oracle Fusion Middleware Application Security Guide*.

Enabling Replication and Oracle Directory Integration Platform Auditing

The following LDIF file enables both replication and Oracle Directory Integration Platform auditing.

```
dn: cn=oid1,cn=osldapd,cn=subconfigsubentry
changetype: modify
replace: orclextconfflag
orclextconfflag: 7
```

The following LDIF file disables both:

```
dn: cn=oid1,cn=osldapd,cn=subconfigsubentry
changetype: modify
replace: orclextconfflag
orclextconfflag: 3
```

Use a command line similar to this:

```
ldapmodify -h host -p port -D "cn=orcladmin" -q -f ldiffile
```

Managing Logging

This chapter describes logging by Oracle Internet Directory. For general information about logging in Oracle Fusion Middleware, see the *Managing Log Files and Diagnostic Data* chapter in the *Oracle Fusion Middleware Administrator's Guide*. This chapter contains these topics:

- [Introduction to Logging](#)
- [Managing Logging by Using Fusion Middleware Control](#)
- [Managing Logging from the Command Line](#)

Introduction to Logging

Like other Oracle Fusion Middleware components, Oracle Internet Directory writes diagnostic log files in the Oracle Diagnostic Logging (ODL) format.

See Also: *Oracle Fusion Middleware Administrator's Guide* for information about ODL.

Oracle Internet Directory tools and servers output their log and trace information to log files in the `ORACLE_INSTANCE`. [Table 23–1](#) lists each component and the location of its corresponding log file.

Table 23–1 Oracle Internet Directory Log File Locations

Tool or Server Name	Log File Name
Bulk Loader (bulkload)	<code>ORACLE_INSTANCE/diagnostics/logs/OID/tools/bulkload.log</code>
Bulk Modifier (bulkmodify)	<code>ORACLE_INSTANCE/diagnostics/logs/OID/tools/bulkmodify.log</code>
Bulk Delete Tool (bulkdelete)	<code>ORACLE_INSTANCE/diagnostics/logs/OID/tools/bulkdelete.log</code>
Catalog Management Tool (catalog)	<code>ORACLE_INSTANCE/diagnostics/logs/OID/tools/catalog.log</code>
Data Export Tool (ldifwrite)	<code>ORACLE_INSTANCE/diagnostics/logs/OID/tools/ldifwrite.log</code>
Directory replication server (oidrepld)	<code>ORACLE_INSTANCE/diagnostics/logs/OID/componentName/oidrepld-XXXX.log</code> where <code>XXXX</code> is a number from 0000 to <code>orclmaxlogfilesconfigured</code> .

Table 23–1 (Cont.) Oracle Internet Directory Log File Locations

Tool or Server Name	Log File Name
Directory server (oidldapd)	<p><i>ORACLE_</i> <i>INSTANCE</i>/diagnostics/logs/OID/<i>componentName</i>/oidldapd01s<i>PID-XXXX</i>.log where:</p> <ul style="list-style-type: none"> ■ 01 is the instance number, which is 01 by default ■ s stands for server ■ PID is the server process identifier ■ XXXX is a number from 0000 to <i>orclmaxlogfilesconfigured</i> <p><i>ORACLE_</i> <i>INSTANCE</i>/diagnostics/logs/OID/<i>componentName</i>/<i>oidstackInstNumber</i><i>PID</i>.log</p> <p>Note: The <i>oidstackInstNumber</i> log files pertain to SIGSEGV/SIGBUS tracing. Also, empty files with this name are created during directory instance startup, and can be ignored.</p>
LDAP dispatcher (oidldapd)	<p><i>ORACLE_</i> <i>INSTANCE</i>/diagnostics/logs/OID/<i>componentName</i>/oidldapd01-<i>XXXX</i>.log where 01 is the instance number, which defaults to 01, and <i>XXXX</i> is a number from 0000 to <i>orclmaxlogfilesconfigured</i>.</p>
OID Monitor (OIDMON)	<p><i>ORACLE_</i> <i>INSTANCE</i>/diagnostics/logs/OID/<i>componentName</i>/oidmon-<i>XXXX</i>.log where <i>XXXX</i> is a number from 0000 to <i>orclmaxlogfilesconfigured</i>.</p>

Features of Oracle Internet Directory Debug Logging

Oracle Internet Directory enables you to:

- View logging information for the directory server, the directory replication server, and the directory integration server
- Set the logging level
- Specify one or more operations for which you want logging to occur
- Search messages in a standard format to determine remedial action for fatal and serious errors
- View trace messages according to their severity and order of importance
- Diagnose Oracle Internet Directory components by examining trace messages with relevant information about, for example, entry DN, ACP evaluation, and the context of an operation

Interpreting Log Messages

This section discusses log messages—those associated with specified LDAP operations and those not. It provides an example of a trace log and explains how to interpret it.

Like other Oracle Fusion Middleware components, Oracle Internet Directory writes diagnostic log files in the Oracle Diagnostic Logging (ODL) format. The *Oracle Fusion Middleware Administrator's Guide* describes ODL format.

Log Messages for Specified LDAP Operations

Log messages for a specified operation are stored as a trace object. This object tracks the operation from start to finish across the various Oracle Internet Directory modules. It is entered in the log file when one of the following occur:

- An LDAP operation completes
- A high priority message is logged
- The trace messages buffer is full

Each thread has one contiguous block of information for each operation, and that block is clearly delimited. This makes it easy, in a shared server environment, to follow the messages of different threads, operations, and connections.

If, because of an internal message buffer overflow, a single trace object cannot contain all the information about an operation, then the information is distributed among multiple trace objects. Each distributed piece of information is clearly delimited and has a common header. To track the progress of the operation, you follow the trace objects and their common header to the end, which is marked with the trace message "Operation Complete".

Log Messages Not Associated with Specified LDAP Operations

Messages not associated with any LDAP operation are represented in a simple format, which is not object-based. It is entered in the log file when either the operation completes or a high priority message is encountered.

A thread that does not perform an operation logs only trace messages. Its header contains the date, time, and the thread identifier. It does not contain the Execution Context ID (ECID) or connection and operation-related information.

A trace object starts with the keyword `BEGIN` and ends with the keyword `END`.

Example: Trace Messages in Oracle Internet Directory Server Log File

```
[2008-11-14T15:28:01-08:00] [OID] [NOTIFICATION:16] [] [OIDLDAPD] [host:
srvhst.us.abccorp.com] [pid: 7043] [tid: 0] Main:: Starting up the OiD Server, on
node srvhst.us.abccorp.com.
```

```
[2008-11-14T15:28:01-08:00] [OID] [NOTIFICATION:16] [] [OIDLDAPD] [host:
srvhst.us.abccorp.com] [pid: 7043] [tid: 0] Main:: Oid Server Connected to DB
store via inst1 connect string.
```

```
[2008-11-14T15:28:01-08:00] [OID] [NOTIFICATION:16] [] [OIDLDAPD] [host:
srvhst.us.abccorp.com] [pid: 7043] [tid: 0] Main:: Loading Root DSE ...
```

```
[2008-11-14T15:28:01-08:00] [OID] [NOTIFICATION:16] [] [OIDLDAPD] [host:
srvhst.us.abccorp.com] [pid: 7043] [tid: 0] Main:: Loading subschema subentry ...
```

```
[2008-11-14T15:28:01-08:00] [OID] [NOTIFICATION:16] [] [OIDLDAPD] [host:
srvhst.us.abccorp.com] [pid: 7043] [tid: 0] Main:: Loading catalog entry ...
```

```
[2008-11-14T15:28:01-08:00] [OID] [NOTIFICATION:16] [] [OIDLDAPD] [host:
srvhst.us.abccorp.com] [pid: 7043] [tid: 0] Main:: OiD LDAP server started.
```

```
[2008-11-14T15:28:02-08:00] [OID] [NOTIFICATION:16] [] [OIDLDAPD] [host:
srvhst.us.abccorp.com] [pid: 7043] [tid: 2] ServerDispatcher : Thread Started
```

```
[2008-11-14T15:28:02-08:00] [OID] [NOTIFICATION:16] [] [OIDLDAPD] [host:
```

```

srvhst.us.abccorp.com] [pid: 7043] [tid: 1] ServerDispatcher : Thread Started

[2008-11-14T15:28:02-08:00] [OID] [NOTIFICATION:16] [] [OIDLDAPD] [host:
srvhst.us.abccorp.com] [pid: 7043] [tid: 3] ServerWorker (REG): Thread Started

[2008-11-14T15:28:02-08:00] [OID] [NOTIFICATION:16] [] [OIDLDAPD] [host:
srvhst.us.abccorp.com] [pid: 7043] [tid: 4] ServerWorker (REG): Thread Started

[2008-11-14T15:28:02-08:00] [OID] [NOTIFICATION:16] [] [OIDLDAPD] [host:
srvhst.us.abccorp.com] [pid: 7043] [tid: 5] ServerWorker (SPW): Thread Started

[2008-11-14T15:28:47-08:00] [OID] [TRACE:16] [] [OIDLDAPD] [host:
srvhst.us.abccorp.com] [pid: 7043] [tid: 3] [ecid:
004MuuNFY7UCknT6uBU4UH0001i30000Ee,0] ServerWorker (REG):[[
BEGIN
  ConnID:87 msgID:2 OpID:1 OpName:bind ConnIP:170.90.11.210 ConnDN:cn=orcladmin
15:28:47-08:00 * gslfbiADoBind * Entry
15:28:47-08:00 * gslfbiGetControlInfo * Entry
15:28:47-08:00 * gslfbiGetControlInfo * Exit
15:28:47-08:00 * gslfbidbDoBind * Version=3 BIND dn="cn=orcladmin" method=128
15:28:47-08:00 * gslsbnrNormalizeString * String to Normalize: "orcladmin"
15:28:47-08:01 * gslsbnrNormalizeString * Normalized value: "orcladmin"
15:28:47-08:01 * gslfrsBSendLdapResult * Entry
15:28:47-08:01 * gslfrsASendLdapResult2 * Entry
15:28:47-08:01 * sgslunwWrite * Entry
15:28:47-08:01 * sgslunwWrite * Exit
15:28:47-08:01 * gslfrsASendLdapResult2 * Exit
15:28:47-08:01 * gslfrsBSendLdapResult * Exit
15:28:47-08:01 * gslfbiADoBind * Exit
TOTAL Worker time : 4402 micro sec
END
]]

[2008-11-14T15:28:56-08:01] [OID] [TRACE:16] [] [OIDLDAPD] [host:
srvhst.us.abccorp.com] [pid: 7043] [tid: 4] [ecid:
004MuuNqbefCknT6uBU4UH0001i30000Lf,0] ServerWorker (REG):[[
BEGIN
  ConnID:126 msgID:1 OpID:0 OpName:bind ConnIP:170.90.11.210 ConnDN:Anonymous
15:28:56-08:01 * gslfbiADoBind * Entry
15:28:56-08:01 * gslfbiGetControlInfo * Entry
15:28:56-08:01 * gslfbiGetControlInfo * Exit
15:28:56-08:01 * gslfbidbDoBind * Version=3 BIND dn="" method=128
15:28:56-08:01 * gslfrsBSendLdapResult * Entry
15:28:56-08:01 * gslfrsASendLdapResult2 * Entry
15:28:56-08:01 * sgslunwWrite * Entry
15:28:56-08:02 * sgslunwWrite * Exit
15:28:56-08:02 * gslfrsASendLdapResult2 * Exit
15:28:56-08:02 * gslfrsBSendLdapResult * Exit
15:28:56-08:02 * gslfbiADoBind * Exit
TOTAL Worker time : 2591 micro sec
END
]]

```

Managing Logging by Using Fusion Middleware Control

You can view log files and configure debug logging with Oracle Enterprise Manager Fusion Middleware Control.

Viewing Log Files by Using Fusion Middleware Control

Select Log Messages to view as follows:

1. From the Oracle Internet Directory menu, select **Logs**, then **View Log Messages**. The Log Messages page appears.
2. Select the date range for the logs you want to view. You can select **Most Recent**, by minutes, hours or days. Alternatively, you can select a **Time Interval** and specify the date and time to start and end.
3. Select the Message Types you want to view.
4. Specify the **Maximum Rows Displayed**.
5. From the **View** list, select **Columns** to change the columns shown. Select **Reorder Columns** to change the order of the columns.
6. Within each column, you can toggle between ascending and descending order by choosing the up or down arrow in the column header.
7. From the Show list, choose whether to show all messages, a summary by message type, or a summary by message id.
8. To perform a specific search, choose **Add Fields** and add fields to search on. For each field, select a criterion from the list, then enter text into the box. Choose the red **X** to delete a field. Choose **Add Fields** to add additional fields. When you have finished adding criteria, choose **Search**.
9. Use the **Broaden Target Scope** list to view messages for the Domain.
10. Choose **Export Messages to File** to export the log messages to a file as XML, text, or comma-separated list.
11. Click **Target Log Files** to view information about individual log files.
12. You can indicate when to refresh the view. Select Manual Refresh, 30-Second Refresh, or One Minute Refresh from the list on the upper right.
13. Use the **View** list to change the columns listed or to reorder columns.
14. Use the **Show** list to change the grouping of messages.
15. Collapse the Search label to view only the list of log messages.
16. To view the contents of a log file, double click the file name in the Log File column. The View Log File: *filename* page is displayed. You can use the up and down arrows in the Time, Message Type, and Message ID to reorder the records in the file.

Configuring Logging by Using Fusion Middleware Control

Table 23–2 Configuration Attributes on Server Properties Page, Logging Tab

Field or Heading	Configuration Attribute
Debug Level	orcldebugflag
Operations Enabled for Debug	orcldebugop
Maximum Log File Size (MB)	orclmaxlogfilesize
Maximum Number of Log Files to Keep in Rotation	orclmaxlogfiles

To configure logging:

1. Select **Administration**, then **Server Properties** from the **Oracle Internet Directory** menu, then select **Logging**.
2. Under **Debug Level**, select the types of activity to be logged.
3. Under **Operations Enabled for Debug**, enable the LDAP operations that you want logged.
4. Under **Logging**, specify values for **Maximum log file size (MB)** and **Maximum number of log files to keep in rotation**. The defaults are 1 MB and 100 log files, respectively.

Note: Values you set on the **Logging** tab of the **Server Properties** page control LDAP server debugging. To set a value for **Replication server debugging**, use the **Replication** tab of the **Shared properties** page as described in "[Configuring the Replication Debug Level by Using Fusion Middleware Control](#)" on page 41-12.

Managing Logging from the Command Line

This section contains the following topics:

- [Viewing Log Files from the Command Line](#)
- [Setting Debug Logging Levels by Using the Command Line](#)
- [Setting the Debug Operation by Using the Command Line](#)
- [Force Flushing the Trace Information to a Log File](#)

Viewing Log Files from the Command Line

You can view Oracle Internet Directory log files in a text editor. See [Table 23–1, "Oracle Internet Directory Log File Locations"](#).

Setting Debug Logging Levels by Using the Command Line

You set debug logging levels by using the `ldapmodify` command.

Because debug levels are additive, you must add the numbers representing the functions that you want to activate, and use the sum of those in the command-line option.

By default, debug logging is turned off. To turn it on, modify the attribute `orcldebugflag` in the instance-specific configuration entry to the level you want.

Note: The DN of an instance-specific configuration entry has the form:

```
cn=componentname,cn=osldapd, cn=subconfigsubentry
```

You can configure debug levels to one of the following levels.

[Table 23–3](#) shows values for `OrclDebugFlag`.

Table 23–3 Values for OrclDebugFlag

Value	Operation
1	Heavy trace debugging
128	Debug packet handling
256	Connection management
512	Search filter processing
1024	Entry parsing
2048	Configuration file processing
8192	Access control list processing
491520	Log of communication with DB
524288	Schema related operations
4194304	Replication specific ops
8388608	Log of entries, operations, and results for each connection
16777216	Trace function call arguments
67108864	Number and identity of clients connected to this server
117440511	All possible operations and data
134217728	All Java plug-in debug messages and internal server messages related to the Java plug-in framework
268435456	All messages passed by a Java plug-in using the ServerLog object.
402653184	Both of the above

For example, to trace search filter processing (512) and connection management (256), enter 768 as the debug level (512 + 256 = 768).

Note: The value of `orcldebugflag` controls LDAP server debugging. To control Replication server debugging, set the value of `orcldebuglevel`, as described in ["Configuring Attributes of the Replication Configuration Set by Using ldapmodify"](#) on page 41-21.

Setting the Debug Operation by Using the Command Line

To make logging more focused, set the debug operations. For example, to limit logging to particular directory server operations, specify those operations. [Table 23–4](#) shows these operations. Any subset of these values can be configured by adding the codes together. For example, to set debugging for `ldapbind` and `ldapadd`, set the value 5 because $1 + 4 = 5$.

Table 23–4 Debug Operations

Debug Operation	Provides Information Regarding
1	<code>ldapbind</code>
2	<code>ldapunbind</code>
4	<code>ldapadd</code>
8	<code>ldapdelete</code>

Table 23–4 (Cont.) Debug Operations

Debug Operation	Provides Information Regarding
16	ldapmodify
32	ldapmodrdn
64	ldapcompare
128	ldapsearch
256	ldapabandon
511	All LDAP operations

To log more than one operation, add the values of their dimensions. For example, if you want to trace ldapbind (1), ldapadd (4) and ldapmodify (16) operations, then create an LDIF file setting the orcldebugop attribute to 21 (1 + 4 + 16 = 21). The LDIF file is as follows:

```
dn: cn=componentname,cn=osldapd,cn=subconfigsubentry
changetype:modify
replace:orcldebugop
orcldebugop:21
```

To load this file, enter:

```
ldapmodify -D "cn=orcladmin" -q -h host_name -p port_number -f file_name
```

Force Flushing the Trace Information to a Log File

To minimize the performance overhead in I/O operations, debug messages are flushed to the log file periodically instead of every time a message is logged by the directory server. Writing to the log file is performed when one of the following occur:

- An LDAP operation completes
- A high priority message is logged
- The trace messages buffer is full

You can, however, view the trace messages in the log file as they are logged without having to wait for the periodic flush. To do this, set the instance-specific configuration entry attribute orcldebugforceflush to 1. Do this by using ldapmodify as shown in the following example.

Example 23–1 Enabling Force Flushing

To enable force flushing by using ldapmodify:

1. Create an LDIF file as follows:

```
dn: cn=componentname,cn=osldapd,cn=subconfigsubentry
changetype: modify
replace: orcldebugforceflush
orcldebugforceflush: 1
```

2. Load this file by entering the following:

```
ldapmodify -D "cn=orcladmin" -q -h host_name -p port_number -f file_name
```

Notes:

- When force flushing is enabled, the format of the trace message object for every operation becomes fragmented.
 - By default, force flushing is disabled. After you have flushed the necessary information to the log file, you should disable force flushing.
-

See Also: "Oracle Identity Management LDAP Attribute Reference" in *Oracle Fusion Middleware Reference for Oracle Identity Management* for information about the `orcldebugforceflush` attribute

Monitoring Oracle Internet Directory

This chapter describes Oracle Internet Directory Manageability framework, which enables you to monitor Oracle Internet Directory. For information on monitoring other Oracle Fusion Middleware components, see the Monitoring Oracle Fusion Middleware chapter in the *Oracle Fusion Middleware Administrator's Guide*.

- [Introduction to Monitoring Oracle Internet Directory Server](#)
- [Setting Up Statistics Collection by Using Fusion Middleware Control](#)
- [Viewing Statistics Information with Fusion Middleware Control](#)
- [Viewing Statistics Information from the Oracle Directory Services Manager Home Page](#)
- [Setting Up Statistics Collection by Using the Command-Line](#)
- [Viewing Information with the OIIDDIAG Tool](#)

Introduction to Monitoring Oracle Internet Directory Server

This introduction contains the following topics:

- [Capabilities of Oracle Internet Directory Server Manageability](#)
- [Oracle Internet Directory Server Manageability Architecture and Components](#)
- [Purging of Security Events and Statistics Entries](#)
- [Account Used for Accessing Server Manageability Information](#)

Capabilities of Oracle Internet Directory Server Manageability

The Oracle Internet Directory Server Manageability framework enables you to monitor the following directory server statistics:

- Server health statistics about LDAP request queues, percent CPU usage, memory, LDAP sessions, and database sessions. For example, you can view the number of active database sessions over a period. You can also view the total number of connections opened to Oracle Internet Directory server instances over a period.
- Performance statistics. Average latency in millisecond is provided for bind, compare, messaging search, and all search operations over a period.
- General statistics about specific server operations, such as add, modify, or delete. For example, you can view the number of directory server operations over a period. You can also view the failed bind operation count.

- User statistics comprising successful and failed operations to the directory and the user performing each one. All LDAP operations are tracked for configured users. Also, the connections held by users at the ends of the statistics collection period are tracked.
- Critical events related to system resources and security—for example, occasions when a user provided the wrong password or had inadequate access rights to perform an operation. Other critical events include ORA errors other than expected errors including 1, 100 or 1403 and abnormal termination of the LDAP server.
- Security events tracking of users' successful and unsuccessful bind and userpassword compare operations.

Because bind and user password compare are among the most security sensitive operations, an exclusive category security event is used to track these two operations. This event tracks the number of these operations performed by LDAP users and applications. The basic information recorded is user DN and source IP address. For failed user password compare, additional information is tracked, specifically, the number of failed compares of one user's password by another user from a given IP address.
- Status information of the directory server and the directory replication server—for example, the date and time at which the directory replication server was invoked

Oracle Internet Directory Server Manageability Architecture and Components

The relationship between the various components of directory server manageability is explained in [Figure 24-1](#) and the accompanying text in [Table 24-1](#).

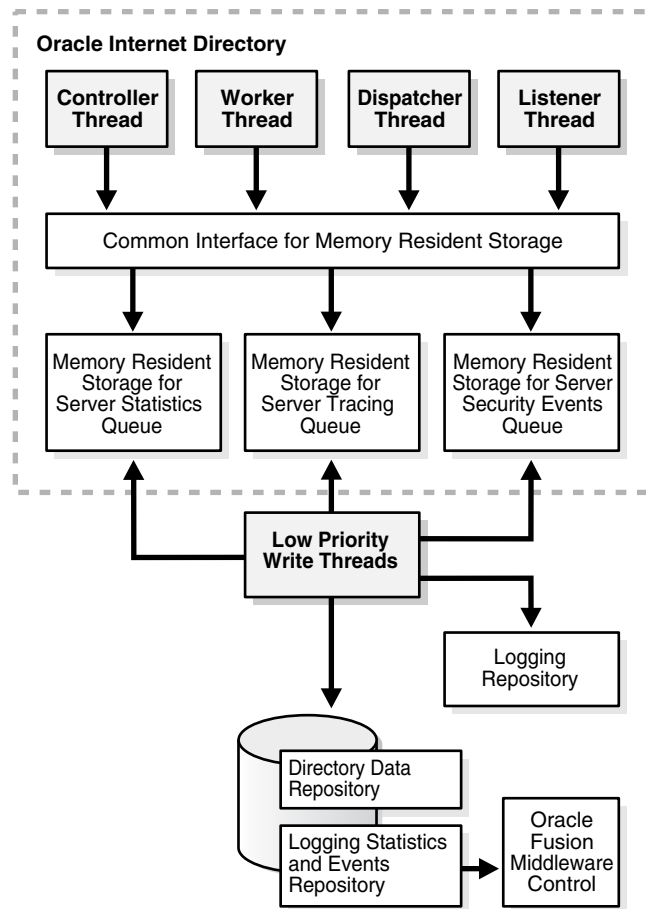
Figure 24–1 Architecture of Oracle Internet Directory Server Manageability**Table 24–1 Components of Oracle Internet Directory Server Manageability**

Component	Description
Oracle Internet Directory	<p>A directory server responds to directory requests from clients. It has four kinds of functional threads: controller, worker, dispatcher, and listener. It accepts LDAP requests from clients, processes them, and sends the LDAP response back to the clients.</p> <p>When you use the Oracle Internet Directory Server Manageability framework to set run-time monitoring, the four functional threads of the server record the specified information and store it in local memory.</p> <p>See Also: "An Oracle Directory Server Instance" on page 3-3 for a description of the directory server</p>
Memory Resident Storage	This is a local process memory. The Oracle Internet DirectoryServer Manageability framework assigns one each for statistics, tracing, and security events. Each has its own separate data structure maintained in the local memory storage.
Low Priority Write Threads	These dedicated write threads differ from server functional threads in that they write server statistics, security events logging, and tracing information to the repository. To maintain reduced system overhead, their priorities are kept low.
External Monitoring Application	This module, which is proprietary and external to the server manageability framework, collects the gathered statistics through a standard LDAP interface with the directory server and stores it in its own repository.
External Repository for Server Management Information	This is the repository that the monitoring agent uses to store the gathered directory server statistics. The monitoring agent determines how this repository is implemented.

Table 24–1 (Cont.) Components of Oracle Internet Directory Server Manageability

Component	Description
Fusion Middleware Control	extracts monitored data from the statistics and events repository, presenting it in a Web-based graphical user interface. Users can view the data in a normal browser. A repository can store the collected data for generic and custom queries.
Logging Repository (File System)	This repository uses a file system to store information traced across various modules of the directory server. By using a file system for this purpose, the Oracle Internet Directory Server Manageability framework uses the features and security of the operating system.
Directory Data Repository	This repository contains all user-entered data—for example, user and group entries.
Statistics and Events Repository	This repository is like the tracing repository except that it stores the information in the same database as the directory data repository rather than in a file system. In this way, the Oracle Internet Directory Server Manageability framework uses: <ul style="list-style-type: none"> ▪ Normal LDAP operations to store and retrieve the information ▪ Existing access control policies to manage the security of the gathered information <p>The directory manageability framework isolates the gathered information from the directory data by storing the two separately.</p>

Purging of Security Events and Statistics Entries

Obsolete statistics entries are removed from Oracle Internet Directory by the Oracle Internet Directory purge tool, described in [Chapter 35, "Managing Garbage Collection"](#).

Account Used for Accessing Server Manageability Information

The Oracle Internet Directory database account ODSSM is used to access server manageability information from the database. During installation, this account's password is set to a value provided by the user at a prompt. The credentials for this account, including the password, are stored in the Oracle Internet Directory snippet in the Oracle Enterprise Manager Fusion Middleware Control file `targets.xml`.

The only way you can change this account's password is to use the procedure documented in ["Changing the Password for the ODSSM Administrator Account"](#) on page 12-8. There is no support in the `oidpasswd` tool for changing this password.

Setting Up Statistics Collection by Using Fusion Middleware Control

This section contains the following topics:

- [Configuring Directory Server Statistics Collection by Using Fusion Middleware Control](#)
- [Configuring a User for Statistics Collection by Using Fusion Middleware Control](#)

Configuring Directory Server Statistics Collection by Using Fusion Middleware Control

To configure statistics collection from Oracle Enterprise Manager Fusion Middleware Control, follow these steps:

1. Select **Administration**, then **Server Properties** from the **Oracle Internet Directory** menu, then select **Statistics**.
2. In the General section of the page, select **Stats Flag** to enable statistics collection.

3. Specify the number of minutes in the Stats Frequency field to control the frequency of statistics collection.
4. Select values from the Bind Security Event Tracking and Compare Security Event Tracking lists.
5. To collect statistics about users, select **User Statistics Collection** in the User Statistics section of the page.
6. In the Event Levels section of the page, select the events you want to track.

Table 24–2 Configuration Attributes on Server Properties Page, Statistics Tab

Field or Heading	Configuration Attribute
Stats Flag	orclstatsflag
Stats Frequency (min)	orclstatsperiodicity
Bind Security Event Tracking and Compare Security Event Tracking	orcloptracklevel
User Statistics	orclstatslevel
Event Levels	orclevntlevel

Notes:

- After you enable User Statistics collection, you also must specify individual users for statistics collection. See "[Configuring a User for Statistics Collection by Using Fusion Middleware Control](#)" on page 24-5.
- If you do not select SuperUser Login as an event level, the corresponding Security values on the Oracle Internet Directory home page is always 0.
- In 11g Release 1 (11.1.1), consecutive settings of `orcldebugflag` and of `orcloptracklevel` are additive.

Configuring a User for Statistics Collection by Using Fusion Middleware Control

Note: If you have configured `orclldapconntimeout` so that idle LDAP connections are closed after a period of time, as described in the Oracle Internet Directory chapter of *Oracle Fusion Middleware Performance and Tuning Guide*, be aware that connections do not time out as per this setting for users who are configured for statistics collection.

To configure a user so that Server Manageability collects statistics for that user:

1. From the Oracle Internet Directory menu, select **Administration**, then **Shared Properties**.
2. Select the **General** tab.
3. Add the user's distinguished name to **User DN**. (This adds the user's DN to the attribute `orclstatsdn`.) For example:

```
cn=Mary Lee, ou=Product Testing, c=us
cn=Michael Smith, ou=Product Testing, c=us
```

cn=Raj Sharma, ou=Human Resources, c=us

Viewing Statistics Information with Fusion Middleware Control

You can use Oracle Enterprise Manager Fusion Middleware Control to view many of the features of Oracle Internet Directory Server Manageability, as explained in this section.

See Also: ["Viewing Queue Statistics by Using Fusion Middleware Control"](#) on page 41-13 for information on replication queue statistics.

Viewing Statistics Information on the Oracle Internet Directory Home Page

The Oracle Internet Directory Home Page displays the following information:

- Performance
 - Average Operation Response Time(ms)
 - Messaging Search Response Time(ms)
 - Bind Response Time(ms)
- Load
 - Total LDAP Connections
 - Operations Completed
 - Operations in progress
- Security
 - Failed Bind Operations
 - Failed SuperUser Logins
 - Successful SuperUser Logins
- Resource Usage
 - CPU Utilization %
 - Memory Utilization %
- Average Response and Load
 - LDAPserverResponse
 - numCompletedOps

Click Table View if you want to see values in tabular form.

In the Security section of the page, the values for Failed Bind Operations, Failed SuperUser Logins, and Successful SuperUser Logins are 0 if you have not enabled collection of these metrics. See ["Setting Up Statistics Collection by Using Fusion Middleware Control"](#) on page 24-4 for more information.

Viewing Information on the Oracle Internet Directory Performance Page

From the **Oracle Internet Directory** menu, select **Monitoring**, then **Performance Summary**. The following metrics are shown by default:

- Server Response

- Total Operations
- Messaging Search Operation Response Time
- Bind Operation Response Time
- Compare Operation Response Time
- Total Number of Security Events Objects in Purge Queue
- Total Number of Security Refresh Events Objects in Purge Queue
- Total Number of System Resource Events Objects in Purge Queue

To display other metrics, expand the Metrics Palette by clicking the arrow on the right edge of the window. You can collapse the Metrics Palette by clicking the arrow on the left edge of the window.

The default time interval is 15 minutes. To change the time interval, click **Slider**, then use the sliders to set the time interval. You can also click the **Date and Time** icon, set the start and end date and time on the Enter Date and Time dialog, then click **OK**.

Click the **Refresh** icon to refresh the page.

The **View** list enables you to view and save charts.

The **Overlay** list enables you to overlay the metrics for a different Oracle Internet Directory target.

Notes:

- For non-critical events, there is a time lag of several minutes, up to `orclstatsperiodicity`, before the corresponding metric is updated.
 - You must click the Refresh icon to see updated metrics.
-
-

Viewing Statistics Information from the Oracle Directory Services Manager Home Page

The Oracle Directory Services Manager home page for Oracle Internet Directory lists the following information:

- Uptime
- LDAP Connections
- OID Procs
- Number of Entries
- LDAP Change Log Entries
- Replication Agreements
- Debug Enabled
- Operation Latency

Setting Up Statistics Collection by Using the Command-Line

This section contains the following topics:

- [Configuring Health, General, and Performance Statistics Attributes](#)

- [Configuring User Statistics Collection from the Command Line](#)
[Configuring Event Levels from the Command Line](#)
[Configuring a User for Statistics Collection by Using the Command Line](#)

Configuring Health, General, and Performance Statistics Attributes

You can use `ldapmodify` and `ldapsearch` to set and view statistics collection-related configuration attributes. These attributes are in the instance-specific configuration entry, as described in [Chapter 9, "Managing System Configuration Attributes."](#)

To enable the collection of health, general, and performance statistics, set the `orclStatsFlag` and `orclStatsPeriodicity` attributes.

For example, to enable the Oracle Internet Directory Server Manageability framework for the component `oid1`, you create an LDIF file that looks like this:

```
dn:cn=oid1,cn=osldapd,cn=subconfigsubentry
changetype: modify
replace: orclstatsflag
orclstatsflag:1
```

To upload this file, enter the following command:

```
ldapmodify -h host -p port_number -D bind_DN -q -f file_name
```

where the bind DN authorized to perform server manageability configuration is `cn=emd admin,cn=oracle internet directory`.

Configuring Security Events Tracking

To configure security events tracking, set the attribute `orcloptracklevel`. This attribute is located in the instance-specific configuration entry, as described in [Chapter 9, "Managing System Configuration Attributes."](#) [Table 24–3](#) lists the values of `orcloptracklevel` to configure different levels of bind and compare information collection:

Table 24–3 Values of `orcloptracklevel`

<code>orcloptracklevel</code> value	Configuration
1	Bind DN only
2	Bind DN and IP address
4	Compare DN only
8	Compare DN and IP address
16	Compare DN, IP address and failure details

The metrics recorded by each `orcloptracklevel` value are listed in the following table:

Table 24–4 Metrics Recorded by Each orcloptracklevel Value

Configuration	Metrics Recorded
DN only	Date and time stamp EID of DN performing the operation Success counts Failure counts
DN and IP address	All metrics listed under DN only Source IP Address
DN, IP address and failure details	All metrics listed under DN and IP address Distinct success counts Distinct failure counts Failure details for each DN performing password compare from an IP Address: <ul style="list-style-type: none"> ▪ Date and time stamp ▪ Source IP Address ▪ EID of DN whose password is compared ▪ Failure counts

The attributes `orcloptrackmaxtotalsize` and `orcloptracknumelemcontainers` enable you to tune memory used for tracking statistics and events. See the Oracle Internet Directory chapter in *Oracle Fusion Middleware Performance and Tuning Guide*.

Configuring User Statistics Collection from the Command Line

To enable user statistics, set the `orclstatslevel` attribute to 1. The `orclStatsPeriodicity` attribute must also be set for user statistics collection to occur.

Note: When you are collecting statistics for Oracle Enterprise Manager Fusion Middleware Control, set `orclStatsPeriodicity` to be the same as the collection periodicity of the Enterprise Manager agent, which is 10 minutes by default.

To configure users for statistics collection, see "[Configuring a User for Statistics Collection by Using the Command Line](#)" on page 24-10.

Configuring Event Levels from the Command Line

The `orclstatsflag` attribute must be set to 1 for event level tracking to occur.

To configure event levels, use `ldapmodify` to set the `orcleventlevel` attribute to one or more of the event levels listed in [Table 24–5](#). The attribute `orcleventlevel` is in the instance-specific configuration entry, as described in [Chapter 9, "Managing System Configuration Attributes."](#)

Table 24–5 Event Levels

Level Value	Critical Event	Information It Provides
1	SuperUser login	Super uses bind (successes or failures)

Table 24–5 (Cont.) Event Levels

Level Value	Critical Event	Information It Provides
2	Proxy user login	Proxy user bind (failures)
4	Replication login	Replication bind (failures)
8	Add access	Add access violation
16	Delete access	Delete access violation
32	Write access	Write access violation
64	ORA 3113 error	Loss of connection to database
128	ORA 3114 error	Loss of connection to database
256	ORA 28 error	ORA-28 Error
512	ORA error	ORA errors other an expected 1, 100, or 1403
1024	Oracle Internet Directory server termination count	
2047	All critical events	

Configuring a User for Statistics Collection by Using the Command Line

Note: If you have configured `orclldapconntimeout` so that idle LDAP connections are closed after a period of time, as described in the Oracle Internet Directory chapter of *Oracle Fusion Middleware Performance and Tuning Guide*, be aware that connections do not time out as per this setting for users who are configured for statistics collection.

To configure a user by using the command line, add the user's DN to the DSA Configset entry's multivalued attribute `orclstatsdn` (DN: `cn=dsaconfig,cn=configsets,cn=oracle internet directory`) by using the `ldapmodify` command line tool. For example, this LDIF file adds Mary Lee to `orclstatsdn`:

```
dn: cn=dsaconfig,cn=configsets,cn=oracle internet directory
changetype:modify
add: orclstatsdn
orclstatsdn: cn=Mary Lee, ou=Product Testing, c=us
```

Use a command line such as:

```
ldapmodify -h host -p port -f ldifFile -D cn=orcladmin -q
```

Viewing Information with the OIDDIAG Tool

Reports for all the statistics can be viewed using the `oiddiag` tool, as follows:

Security Events

```
oiddiag audit_report=true [outfile=file_name]
```

All Statistics and Events

```
oiddiag collect_all=true, [outfile=file_name]
```

Subset of Statistics and Events

```
oiddiag collect_sub=true [infile=input_file_name, outfile=file_name ]
```

where *input_file_name* is created by taking the output from

```
oiddiag listdiags=true
```

and removing unwanted statistics classes.

Note: On Windows, the filename of the `oiddiag` command is `oiddiag.bat`.

See Also:

- The `oiddiag` command tool reference in *Oracle Fusion Middleware Reference for Oracle Identity Management*.
- The chapter about administration tools in the *Oracle Fusion Middleware Administrator's Guide*

Backing Up and Restoring Oracle Internet Directory

This chapter tells how to backup and restore both small and large directories. It contains these topics:

- [Introduction to Backing Up and Restoring Oracle Internet Directory](#)
- [Backing Up and Restoring a Small Directory or Specific Naming Context](#)
- [Backing Up and Restoring a Large Directory](#)

Introduction to Backing Up and Restoring Oracle Internet Directory

You can back up a small directory or a specific naming context by using `ldifwrite`. For larger directories, perform an Oracle Fusion Middleware backup. See the chapters on backup and recovery in *Oracle Fusion Middleware Administrator's Guide*.

Backing Up and Restoring a Small Directory or Specific Naming Context

To backup and restore a small directory or specific naming context in directory, do the following:

1. Back up the node, as follows:
 - a. Ensure that the environment variable `ORACLE_INSTANCE` is set correctly.
 - b. Ensure all Oracle Internet Directory servers, both LDAP and replication, are stopped on the node.
 - c. Enter this command:

```
ldifwrite connect="connect_string" basedn="naming_context" \  
ldiffile="backup.ldif"
```

2. Start the directory server on the new node by entering this command:

```
opmnctl startproc process-type=OID
```

3. Load data into the new node by using the `bulkload` utility. Enter this command:

```
bulkload connect="connect_string" check="TRUE" generate="TRUE" \  
load="TRUE" restore="TRUE" append="TRUE" file="/complete_path/backup.ldif"
```

Note: If you back up data from an earlier version of Oracle Internet Directory, such as 10g Release 2 (10.1.2.0.2), then restore it on a node running 10g (10.1.4.0.1) or later, you must update the password policy entries as described in "Password Policy and Fan-out Replication" on page 30-32.

Backing Up and Restoring a Large Directory

For instructions on backing up and restoring a large directory, see the backup and recovery chapter in *Oracle Fusion Middleware Administrator's Guide*.

Part III

Advanced Administration: Security

This part explains how to:

- Secure data within the directory
- Establish access controls for administering applications in enterprises and hosted environments
- Establish and manage policies governing passwords
- Manage password verifiers used to authenticate users to other Oracle components
- Store data for users, groups, and services in one repository, and delegate the administration of that data to various administrators

It contains these chapters:

- [Chapter 26, "Configuring Secure Sockets Layer \(SSL\)"](#)
- [Chapter 27, "Configuring Data Privacy"](#)
- [Chapter 28, "Managing Password Policies"](#)
- [Chapter 29, "Managing Directory Access Control"](#)
- [Chapter 30, "Managing Password Verifiers"](#)
- [Chapter 31, "Delegating Privileges for Oracle Identity Management"](#)
- [Chapter 32, "Managing Authentication"](#)

Configuring Secure Sockets Layer (SSL)

This chapter explains how to configure Secure Sockets Layer (SSL) for use with Oracle Internet Directory. If you use Secure Sockets Layer (SSL), you may also configure strong authentication, data integrity, and data privacy.

This chapter contains these topics:

- [Introduction to Configuring Secure Sockets Layer \(SSL\)](#)
- [Configuring SSL by Using Fusion Middleware Control](#)
- [Configuring SSL by Using WLST](#)
- [Configuring SSL by Using LDAP Commands](#)
- [Testing SSL Connections by Using Oracle Directory Services Manager](#)
- [Testing SSL Connections From the Command Line](#)
- [Configuring SSL Interoperability Mode](#)

See Also:

- "Security" on page 3-14 for a conceptual overview of SSL in relation to Oracle Internet Directory
- [Chapter 32, "Managing Authentication"](#).
- The SSL Configuration Service chapter in *Oracle Fusion Middleware Administrator's Guide*.
- The SSL Automation Tool chapter in *Oracle Fusion Middleware Administrator's Guide*. The SSL Automation Tool enables you to configure SSL for multiple components using a domain-specific CA.

Introduction to Configuring Secure Sockets Layer (SSL)

Oracle Internet Directory ensures that data has not been modified, deleted, or replayed during transmission by using Secure Sockets Layer (SSL). SSL generates a cryptographically secure message digest—through cryptographic checksums using either the MD5 algorithm or the Secure Hash Algorithm (SHA)—and includes it with each packet sent across the network. SSL provides authentication, encryption, and data integrity using message digest.

This introduction contains the following topics:

- [Supported Cipher Suites](#)
- [Supported Protocol Versions](#)

- [SSL Authentication Modes](#)
- [Limitations of the Use of SSL in 11g Release 1 \(11.1.1\)](#)
- [Other Components and SSL](#)
- [SSL Interoperability Mode](#)
- [StartTLS](#)

Oracle Internet Directory ensures that data is not disclosed during transmission by using public key encryption available with SSL. In public-key encryption, the sender of a message encrypts the message with the public key of the recipient. Upon delivery, the recipient decrypts the message using the recipient's private key.

Supported Cipher Suites

A cipher suite is a set of authentication, encryption, and data integrity algorithms used for exchanging messages between network nodes. During an SSL handshake, the two nodes negotiate to determine which cipher suite they will use when transmitting messages back and forth.

[Table 26–1](#) lists the SSL cipher suites supported by Oracle Internet Directory and their corresponding authentication, encryption, and data integrity mechanisms. These are stored in the attribute `orclsslcpiphersuite` in the instance-specific configuration entry.

Table 26–1 SSL Cipher Suites Supported in Oracle Internet Directory

Cipher Suite	Authentication	Encryption	Data Integrity
SSL_RSA_WITH_3DES_EDE_CBC_SHA	RSA	3DES	SHA
SSL_RSA_WITH_RC4_128_SHA	RSA	RC4	SHA
SSL_RSA_WITH_RC4_128_MD5	RSA	RC4	MD5
SSL_RSA_WITH_DES_CBC_SHA	RSA	DES	SHA
SSL_RSA_EXPORT_WITH_RC4_40_MD5	RSA	RC4_40	MD5
SSL_RSA_EXPORT_WITH_DES40_CBC_SHA	RSA	DES40	SHA
SSL_DH_anon_WITH_3DES_EDE_CBC_SHA	None	3DES	SHA
SSL_DH_anon_WITH_RC4_128_MD5	None	RC4	MD5
SSL_DH_anon_WITH_DES_CBC_SHA	None	DES	SHA
SSL_RSA_WITH_AES_128_CBC_SHA	RSA	AES	SHA
SSL_RSA_WITH_AES_256_CBC_SHA	RSA	AES	SHA

Supported Protocol Versions

Oracle Internet Directory supports the following TLS/SSL protocols:

- SSLv3
- TLSv1
- SSLv3 with SSLv2 Hello

Oracle Internet Directory does not support SSLv2.

TLSv1 can use all of the cipher suites listed in [Table 26–1](#). SSLv3 and SSLv3 with SSLv2 Hello can use the first 10 cipher suites listed in [Table 26–1](#). They cannot use the AES

ciphers.SL_RSA_WITH_AES_128_CBC_SHA or SSL_RSA_WITH_AES_256_CBC_SHA.

SSL Authentication Modes

The SSL protocol provides transport layer security with authenticity, integrity, and confidentiality, for a connection between a client and server. Three authentication modes are supported, as described in [Table 26-2](#). The SSL authentication mode is controlled by the attribute `orclsslauthentication` in the instance-specific configuration entry.

Table 26-2 SSL Authentication Modes

SSL Authentication Method	Value of <code>orclsslauthentication</code>	Authentication Behavior
SSL No Authentication Mode, Confidentiality mode	1	Neither the client nor the server authenticates itself to the other. No certificates are sent or exchanged. Only SSL encryption and decryption is used.
SSL Server Authentication Only Mode	32	The directory server authenticates itself to the client. The directory server sends the client a certificate asserting the server's identity.
SSL Client and Server Authentication Mode	64	The client and server authenticate themselves with each other and send certificates to each other.

By default, Oracle Internet Directory uses SSL No Authentication Mode (`orclsslauthentication=1`).

When both a client and server authenticate themselves with each other, SSL derives the identity information it requires from the X509v3 digital certificates.

See Also: [Chapter 32, "Managing Authentication"](#).

Notes:

- By default, the SSL authentication mode is set to authentication mode 1 (encryption only, no authentication). Be sure at least one Oracle Internet Directory server instance has this default authentication mode. Otherwise, you break Oracle Delegated Administration Services and other applications that expect to communicate with Oracle Internet Directory on the encrypted SSL port.
 - Replication does not work with SSL Server Authentication or SSL Client and Server Authentication.
-
-

During start-up of a directory server instance, the directory reads a set of configuration parameters, including the parameters for the SSL profile.

To run a server instance in secure mode, configure a single listening endpoint to communicate using LDAPS. To allow the same instance to run non-secure connections concurrently, configure a second listening endpoint to communicate using LDAP.

During installation of Oracle Internet Directory, Oracle Identity Management 11g Installer follows specific steps in assigning the SSL and non-SSL port. First, it attempts to use 3060 as the non-SSL port. If that port is unavailable, it tries ports in the range

3061 to 3070, then 13060 to 13070. Similarly, it attempts to use 3131 as its SSL port, then ports in the range 3132 to 3141, then 13131 to 13141.

Note: If you perform an upgrade from an earlier version of Oracle Internet Directory to 11g Release 1 (11.1.1), your port numbers from the earlier version are retained.

You can create and modify multiple Oracle Internet Directory instances with differing values, using a different SSL parameters. This is a useful way to accommodate clients with different security needs.

See Also: [Chapter 8, "Managing Oracle Internet Directory Instances"](#) for information about creating a new server instance.

Limitations of the Use of SSL in 11g Release 1 (11.1.1)

The Oracle directory replication server cannot communicate directly with an SSL-enabled LDAP server that supports two way (mutual) authentication. The replication server startup fails and hangs if the LDAP server is configured for SSL mutual authentication.

Oracle Wallets

Oracle Wallet is a secure software container that is used to store X509 certificates, Private key, and trusted CA certificates. A self-signed certificate can be stored in Oracle Wallet that can be within an enterprise.

Before removing the reference to the wallet from the instance-specific configuration, you must disable SSL by setting `orclsslenable` to 0.

See Also: *Oracle Fusion Middleware Administrator's Guide* for information on using Oracle wallets with middleware components.

Never delete a wallet currently in use, as defined in the attribute `orclsslwalleturl`, from the file system. Doing so prevents the server from starting successfully. Remove the reference to the wallet from the instance-specific configuration entry attribute `orclsslwalleturl` before you delete the file.

In 11g, you do not need to directly manipulate `orclsslwalleturl` because the SSL configuration service abstracts this out, both in WLST and Oracle Enterprise Manager Fusion Middleware Control. The SSL configuration service traps any attempts to delete a wallet that is currently in use, provided you do so by using the SSL configuration service.

Other Components and SSL

At installation, Oracle Internet Directory starts up in dual mode. That is, some components can access Oracle Internet Directory using non-SSL connections, while others use SSL when connecting to the directory. By default, Oracle Application Server components are configured to run in this dual mode environment when communicating with Oracle Internet Directory. If you want, you can remove the non-SSL mode and change all middleware instances to use SSL.

Enterprise User Security or a customer application might need an SSL channel with a different configuration from the default. For example, it might need SSL server authentication mode or SSL mutual authentication mode. In this case, you must create

another Oracle Internet Directory component instance listening on a different SSL mode and port.

See Also: [Chapter 8, "Managing Oracle Internet Directory Instances"](#) for instructions on how to configure server instances

For more information about Enterprise User Security SSL configuration, please see the section on enterprise user security configuration in *Oracle Database Enterprise User Administrator's Guide*.

SSL Interoperability Mode

In no-auth mode, Oracle components developed before 11g Release 1 (11.1.1) can only connect with Oracle Internet Directory using an instance that has interoperability mode enabled (`orclsslinteropmode = 1`). For compatibility with those components, SSL interoperability mode is enabled by default.

New clients using JSSE (Java Secure Socket Extensions), and non-Oracle clients, need an SSL instance with the interopmode disabled. Oracle Internet Directory is fully compliant with the Sun JDK's SSL, provided SSL interoperability mode is disabled (`orclsslinteropmode = 0`).

If Oracle Internet Directory is set to the wrong mode for a client, you might observe rare an non-deterministic failures of client SSL connections to the server.

See Also: ["Configuring SSL Interoperability Mode"](#) on page 26-13.

StartTLS

Beginning with 11g Release 1 (11.1.1), Oracle Internet Directory supports startTLS. This feature enables the on-demand negotiation of an SSL session on a non-SSL port. No special configuration is required for the non-SSL port. If Oracle Internet Directory has an SSL endpoint configured, a client can use startTLS on the non-SSL port to negotiate an SSL connection on the non-SSL port with the same configuration that is on the SSL port. That is, if the SSL port uses mutual authentication, startTLS tries to negotiate mutual authentication on the non-SSL port.

Configuring SSL by Using Fusion Middleware Control

Configuring SSL by using Fusion Middleware Control consists of three basic tasks:

1. [Creating a Wallet by Using Fusion Middleware Control](#)
2. [Configuring SSL Parameters by Using Fusion Middleware Control](#)
3. Restarting Oracle Internet Directory.

See Also:

- [Chapter 8, "Managing Oracle Internet Directory Instances"](#) for instructions on how to stop and start the server.
- ["Configuring Certificate Authentication Method by Using Fusion Middleware Control"](#) on page 32-6
- *Oracle Fusion Middleware Reference for Oracle Identity Management* for descriptions of the SSL parameters

Creating a Wallet by Using Fusion Middleware Control

To create a self-signed wallet to use when configuring SSL, perform the following steps:

1. From the Oracle Internet Directory menu, select **Security**, then **Wallets**. If any wallets exist, you see a list.
2. To create a new wallet, click **Create Self-Signed Wallet**. The Create Self-Signed Wallet page appears.

Oracle Internet Directory Page Refreshed Feb 6, 2009 3:13:56 PM PST

Wallests > Create Self-Signed Wallet

Create Self-Signed Wallet OK Cancel

A self signed wallet is not signed by a well known CA. A self-signed wallet is not recommended in a production environment. The wallet name should be unique for a given component. The wallet type can be auto-login or password-protected. Passwords, if specified, have a minimum length of eight characters, and contain alphabetic characters combined with numeric or special characters. Auto-login wallet is an obfuscated form of PKCS#12 wallet that provides PKI-based access to services and applications without requiring a password at runtime. Auto-login wallet don't need a password to modify, or delete the wallet. File system permissions provide the necessary security for Auto-login wallets.

Self-Signed Wallet Details

* Wallet Name

Auto-login

Wallet Password

Confirm Password

Add Self-Signed Certificate
Add a self-signed certificate that becomes part of the wallet.

* Common Name

Organizational Unit

Organization

City

State

Country

Key Size

3. On the Create Self-Signed Wallet page, enter a name for the new wallet, using lower-case letters only.
4. Select **Auto Login** for an auto login wallet. Deselect **Auto Login** for a password-protected wallet.
5. If you have deselected **Auto Login**, enter the password in the two fields.
6. For **Common Name**, enter the hostname of the instance.
7. Select a **Key Size** from the list.
8. Click **Submit**.
9. A confirmation message is displayed and the new wallet appears in the list of wallets.

Oracle Internet Directory Page Refreshed Feb 6, 2009 3:16:12 PM PST

Confirmation
Self-signed wallet selfsigned successfully created

Wallets
A Wallet is a Keystore that stores X.509 certificates and private keys in industry-standard, PKCS #12 format. To create a wallet, click Create. To create a wallet with a self-signed certificate, click Create Self-Signed Wallet. To manage the contents of a wallet, select a wallet and click Manage.

Name	Auto-login
oid2	
selfsigned	✓

See Also: *Oracle Fusion Middleware Administrator's Guide* for more information about Oracle wallets.

Configuring SSL Parameters by Using Fusion Middleware Control

After you have a wallet to use for configuring SSL, perform the following steps:

1. From the Oracle Internet Directory menu, select **Administration**, then **Server Properties**.

2. Click **Change SSL Settings**.
3. On the SSL Settings dialog:

- Select **Enable SSL**.
 - Select a wallet.
 - If this is a non auto login wallet, supply the wallet password in the Server Wallet Password field.
 - If necessary, expand **Advanced SSL Settings**.
 - Set SSL Authentication to **Server**.
 - Set Cipher Suite to **All**.
 - Set SSL protocol version to the appropriate version, usually **v3**.
 - Click **OK**.
4. Restart the Oracle Internet Directory instance by navigating to **Oracle Internet Directory**, then **Availability**, then **Restart**.

The steps for SSL-enabling in mutual-auth mode are the same, except that in the SSL Settings dialog, you would set SSL Authentication to **Mutual** instead of **Server**.

Note: You cannot directly change the parameters for an active instance.

Setting SSL Parameters with Fusion Middleware Control

Table 26–3 lists the SSL parameters in Oracle Enterprise Manager Fusion Middleware Control that are applicable to Oracle Internet Directory. All of them are in the instance-specific configuration entry, which has a DN of the form:

```
"cn=componentname,cn=osdldapd,cn=subconfigsentry."
```

SSL Attributes

Table 26–3 SSL-Related Attributes in Fusion Middleware Control

Field or Heading	Configuration Attribute
Server SSL Protocol Version	orclsslversion
SSL Wallet URL	orclsslwalleturl
Enable SSL	orclsslenable
SSL Authentication Mode	orclsslauthentication
Server Cipher Suite	orclssliphersuite

You must restart the server for SSL configuration changes to take effect.

Configuring SSL by Using WLST

You must perform the following steps to configure SSL:

1. Create an Oracle wallet.
2. Configure SSL parameters.
3. Restart Oracle Internet Directory.

To create an Oracle wallet and configure SSL parameters by using `wlst`, perform the following steps:

1. Invoke `wlst` and connect to the host, specifying the username, password, and port of the WebLogic administration server.

```
ORACLE_COMMON_HOME/common/bin/wlst.sh
connect('username', 'password', 'localhost:7001')
```

2. Navigate to the custom mbean tree, then to the specific mbean `oracle.as.oid`, as described in "Managing System Configuration Attributes by Using WLST" on page 9-14.

```
custom()
ls()
cd('oracle.as.oid')
ls()
```

3. Determine what certificates, if any, you already have in the Key Store MBean. See Table 9–7, "Oracle Internet Directory-Related MBeans".

```
listWallets('app_server_instance', 'oid_component', 'oid')
```

For example:

```
listWallets('inst1', 'oid1', 'oid')
```

4. If Necessary, create a new self-signed certificate.

```
createWallet('inst1',
            'oid1',
            'oid',
            'WALLET_NAME',
            'WALLET_PASSWORD')
```

5. Add a self-signed certificate to the wallet for use as the server certificate.

```
addSelfSignedCertificate('inst1',
                        'oid1',
                        'oid',
                        'WALLET_NAME',
                        'WALLET_PASSWORD',
                        'cn=INSTANCE_HOST_NAME',
                        'key_size',
                        'alias=server-cert')
```

If you want to use a third-party or custom Certificate Authority-issued certificate, instead of a self-signed certificate, you must first import the certificate. See the chapter on managing keystores, wallets, and certificates in *Oracle Fusion Middleware Administrator's Guide* for instructions.

6. Configure the `oid1` component node's listener/port for SSL, specifying the appropriate authentication mode:

```
configureSSL('app_server_instance',
            'oid_component',
            'oid',
            'sslport1',
            'property_file.prop')
```

For an Oracle Internet Directory component the listener port is always `sslport1` and the component type is always `oid`. For example:

```
configureSSL('inst1',
            'oid1',
            'oid',
            'sslport1',
            'myfile.prop')
```

where `myfile.prop` contains:

```
KeyStore=WALLET_NAME
AuthenticationType=auth-type
SSLVersions=version
Ciphers=cipher
SSLEnabled=true
```

See *Oracle Fusion Middleware Administrator's Guide* for information about property files for SSL.

7. Restart Oracle Internet Directory, as described in [Chapter 8, "Managing Oracle Internet Directory Instances,"](#) to activate the changes
8. Run `opmnctl updatecomponentregistration`, as described in ["Updating the Component Registration of an Oracle Instance by Using opmnctl"](#) on page 8-8
9. Verify that SSL is enabled by using the methods described in ["Testing SSL Connections by Using Oracle Directory Services Manager"](#) on page 26-11 and ["Testing SSL Connections From the Command Line"](#) on page 26-11.

Note: WLST manages Oracle Internet Directory through its SSL port. The Oracle Internet Directory SSL port must be configured for no authentication or server authentication. If the Oracle Internet Directory SSL port is configured for mutual authentication, you will not be able to change Oracle Internet Directory parameters by using WLST. See ["SSL Authentication Modes"](#) on page 26-3.

See Also:

- *Oracle Fusion Middleware Administrator's Guide* for more information about `wlst` commands.
- *Oracle Fusion Middleware Administrator's Guide* for information on using Oracle wallets with middleware components.

Configuring SSL by Using LDAP Commands

You must perform the following steps to configure SSL:

1. Create an Oracle wallet.
2. Configure SSL parameters.
3. Restart Oracle Internet Directory.

See Also:

- [Chapter 8, "Managing Oracle Internet Directory Instances"](#) for instructions on how to stop and start the server.
- ["Configuring Certificate Authentication Method by Using Command-Line Tools"](#) on page 32-6
- *Oracle Fusion Middleware Reference for Oracle Identity Management* for descriptions of the SSL parameters

Note: You can also use `orapki` to configure a wallet. See *Oracle Fusion Middleware Administrator's Guide*

If you already have created a wallet, you can use the `ldapmodify` command instead of `wlst` to change SSL parameters.

For example, to change the value of `orclsslinteropmode` to 1 for the instance `oid1`, you would type:

```
ldapmodify -D cn=orcladmin -q -p portNum -h hostname -f ldifFile
```

where `ldifFile` contains:

```
dn: cn=oid1,cn=osdldapd,cn=subconfigsentry
changetype: modify
replace: orclsslinteropmode
orclsslinteropmode: 1
```

SSL parameters are attributes of an instance-specific configuration entry. These configuration entries have DN's of the form:

```
cn=componentname,cn=osdldapd,cn=subconfigsentry
```

for example:

```
cn=oid1,cn=osldapd,cn=subconfigsentry
```

The SSL attributes are shown in [Table 26–4](#).

Table 26–4 SSL Attributes

Attribute	Meaning
orclsslversion	SSL Version
orclsslwalleturl	SSL Wallet URL
orclsslenable	SSL Enable
orclsslauthentication	SSL Authentication
orclsslinteropmode	SSL Interoperability Mode
orclssliphersuite	SSL Cipher Suite

You can use the `ldapsearch` command to list the SSL attributes and their values. For example, to list attributes containing the string `orclssl` in the instance `oid1`, you would type:

```
ldapsearch -p 3060 -D cn=orcladmin -q \
  -b "cn=oid1,cn=osldapd,cn=subconfigsentry" \
  -s base "objectclass=*" | grep -i orclssl
```

After you have configured SSL Parameters, restart Oracle Internet Directory., as described in [Chapter 8, "Managing Oracle Internet Directory Instances."](#)

Note: Do not set `orclsslenable` to 1 (SSL only) if you use Oracle Enterprise Manager Fusion Middleware Control or WLST to manage Oracle Internet Directory. Those utilities manage the server through MBeans, which use SASL over a non-SSL connection.

Testing SSL Connections by Using Oracle Directory Services Manager

To test the SSL connection by using Oracle Directory Services Manager:

1. Invoke ODSM as described in ["Invoking Oracle Directory Services Manager"](#) on page 7-9
2. Connect to the Oracle Internet Directory server. On the login screen, enable SSL and specify the SSL port.

If you can connect, the SSL connection is working correctly.

Testing SSL Connections From the Command Line

You can use the `ldapbind` command to test SSL connections. On UNIX, the syntax is:

```
ldapbind -D cn=orcladmin -q -U authentication_mode -h host -p SSL_port \
  -W "file://DIRECTORY_CONTAINING_WALLET" -Q
```

and on Windows, the syntax is:

```
ldapbind -D cn=orcladmin -q -U authentication_mode -h host -p SSL_port \
  -W "file:device:\DIRECTORY_CONTAINING_WALLET" -Q
```

where *authentication_mode* is one of:

Number	Authentication
1	SSL No authentication required.
2	One-way (server only) SSL authentication required.
3	Two-way (client and server) SSL authentication required.

See Also: The `ldapbind` command-line tool reference in *Oracle Fusion Middleware Reference for Oracle Identity Management*.

Testing SSL With Encryption Only

Use this method to test an SSL configuration with SSL no authentication required. The syntax is:

```
ldapbind -D cn=orcladmin -q -U 1 -h host -p SSL_Port
```

Testing SSL With Server Authentication

Use this method to test an SSL configuration with SSL server authentication configured. A client can request either server authentication or no authentication.

For an anonymous bind with server authentication, the syntax is:

```
ldapbind -U 2 -h host -p port -W "file:DIRECTORY_CONTAINING_WALLET" -Q
```

For a bind with user `cn=orcladmin`, wallet file `ORACLE_INSTANCE/OID/admin/mywallet`, and server authentication, the syntax is:

```
ldapbind -D cn=orcladmin -q -U 2 -h host -p port \  
-W "file:ORACLE_INSTANCE/OID/admin/mywallet" -Q
```

For a bind without SSL authentication, the syntax is:

```
ldapbind -D cn=orcladmin -q -U 1 -h host -p SSL_Port
```

Testing SSL With Client and Server Authentication

Use this method to test an SSL configuration with SSL client and server authentication configured.

Oracle Internet Directory supports the Certificate Matching Rule. The DN and password passed on the `ldapbind` command line are ignored. Only the DN from the certificate or the certificate hash is used for authorization.

See Also: ["Direct Authentication"](#) on page 32-1.

To use the bind DN (Distinguished Name) from the client certificate, the syntax is:

```
ldapbind -U 3 -h host -p port -W "file:DIRECTORY_CONTAINING_WALLET" -Q
```

Configuring SSL Interoperability Mode

See ["SSL Interoperability Mode"](#) on page 26-5 for a description of interoperability mode.

To set SSL interoperability mode for compatibility with Oracle components developed before 11g Release 1 (11.1.1) use the command:

```
ldapmodify -D cn=orcladmin -q -p portNum -h hostname -f ldifFile
```

where *ldifFile* contains:

```
dn: cn=oid1,cn=osldapd,cn=subconfigsubentry  
changetype: modify  
replace: orclsslinteropmode  
orclsslinteropmode: 1
```

After you have configured SSL Parameters, restart Oracle Internet Directory, as described in [Chapter 8, "Managing Oracle Internet Directory Instances."](#)

Configuring Data Privacy

Data privacy is a concern both during transmission and after the data is received. During transmission, data is protected with SSL. This chapter explains how Oracle Internet Directory protects data after it is received.

This Chapter contains the following topics:

- [Introduction to Table Space Encryption](#)
- [Enabling and Disabling Table Space Encryption](#)
- [Introduction to Using Database Vault With Oracle Internet Directory](#)
- [Configuring Oracle Database Vault to Protect Oracle Internet Directory Data](#)
- [Best Practices for Using Database Vault with Oracle Internet Directory](#)
- [Introduction to Sensitive Attributes](#)
- [Configuring Privacy of Retrieved Sensitive Attributes](#)
- [Introduction to Hashed Attributes](#)
- [Configuring Hashed Attributes](#)

Introduction to Table Space Encryption

Oracle Database Transparent Data Encryption (TDE), a component of Oracle Enterprise User Security, transparently encrypts data when it is written to disk and decrypts it when it is read back to the authorized user. TDE helps protect data stored on media if the storage media or data file gets stolen. Applications don't have to be modified, and the data encryption on the storage media is transparent to users.

Oracle Database 11g Advanced Security Transparent Data Encryption introduced support for encryption of database table spaces. All objects created in an encrypted tablespace are automatically encrypted. All data in an encrypted tablespace is stored in encrypted format on the disk. Data blocks are transparently decrypted as they are accessed by the Oracle Database. Table space encryption eliminates the foreign key restriction of column encryption and enables index range scans on encrypted data.

Enabling and Disabling Table Space Encryption

To enable or disable table space encryption on Oracle Databases used by Oracle Internet Directory, follow these steps:

Note: If you have previously enabled and disabled table space encryption, and you are enabling it again, skip to Step 7.

1. Make a cold backup of the Oracle Databases that are used by the Oracle Internet Directory instances.
2. Make sure you have the JavaVM and XML developer's Kit packages installed in the database Oracle home.

To verify whether the specified packages are installed, execute the following SQL*Plus:

```
SELECT comp_id, status FROM dba_registry;
```

Execute the following PL/SQL procedure:

```
sys.dbms_metadata_util.load_stylesheets
```

3. Log in to SQL*Plus as a user who has the SYSTEM privilege and execute the following command:

```
GRANT CREATE ANY DIRECTORY TO ods;
```
4. Create the directory object, log directory object used for dumpfiles, and logfiles of the Oracle DataPump utility. Log in to SQL*Plus as the ODS user and execute the following commands:

```
CREATE OR REPLACE DIRECTORY directory_object_name as directory_path;  
CREATE OR REPLACE DIRECTORY log_directory_object_name as log_directory_path;
```
5. Create *directory_path* and *log_directory_path* in the file system.
6. Set the database wallet location in the `sqlnet.ora` of the database Oracle home.

Note: Do not confuse the database wallet with the Oracle Internet Directory wallet described in [Chapter 26](#).

Oracle recommends that you use a separate wallet exclusively for table space encryption.

- a. To use a separate database wallet for table space encryption, set the parameter ENCRYPTION_WALLET_LOCATION in `sqlnet.ora`. For example:

```
ENCRYPTION_WALLET_LOCATION=(SOURCE=(METHOD=FILE) (METHOD_  
DATA=(DIRECTORY=/install/db11g/dbs)))
```

- b. To use the same database wallet shared by all Oracle components, set the parameter WALLET_LOCATION in `sqlnet.ora`. For example:

```
WALLET_LOCATION= (SOURCE=(METHOD=FILE) (METHOD_  
DATA=(DIRECTORY=/install/db11g/dbs)))
```

7. Shut down all the Oracle Internet Directory instances that are using the Oracle Database Oracle home.
8. If you are enabling table space encryption for the first time in the Oracle Database Oracle home, log in to SQL*Plus as a user who has the ALTER SYSTEM privilege and execute the following command:

```
ALTER SYSTEM SET ENCRYPTION KEY IDENTIFIED BY yourwalletpassword;
```

9. Whenever the Oracle Database is shut down and restarted, log in to SQL*Plus as a user who has the ALTER SYSTEM privilege and execute the following command:

```
ALTER SYSTEM SET ENCRYPTION WALLET OPEN IDENTIFIED BY yourwalletpassword;
```

Be sure to execute the command before starting Oracle Internet Directory and before running the Perl script shown in Step 12.

10. Set the environment variable ORACLE_HOME to the Oracle Database home.
11. Set the environment variable NLS_LANG to the character set of the Oracle Database server.
12. Edit the path of the perl5 executable in the Perl script `ORACLE_HOME/ldap/datasecurity/oidtbltde.pl` so that it matches the location of perl5 on your computer.
13. If you have not already done so, install the database independent interface module for Perl (DBI) and the Oracle DBD driver for Perl.
14. Run the Perl script `oidtbltde.pl` to enable or disable TDE for Oracle Internet Directory

Introduction to Using Database Vault With Oracle Internet Directory

Oracle Internet Directory enforces access control in the LDAP protocol layer. However, a privileged user such as DBA can normally access the Oracle Internet Directory data in the underlying database by using SQL*Plus.

You can use Oracle Database Vault to prevent unauthorized access to Oracle Internet Directory data by a privileged user. To do so, you must install and enable Oracle Database Vault, set up a Database Vault realm containing the ODS database schema used by Oracle Internet Directory, and set up a policy to allow only the ODS database account to access the data.

See Also:

- *Oracle Database 2 Day + Security Guide* for a quick guide to installing, enabling, and disabling Oracle Database Vault
- *Oracle Database Vault Administrator's Guide* for detailed information about administering Oracle Database Vault

Configuring Oracle Database Vault to Protect Oracle Internet Directory Data

You must install and register Oracle Database Vault before you configure it for Oracle Internet Directory. You install Database Vault as part of the Oracle Database installation.

Registering Oracle Database Vault

If you do not know whether Oracle Database Vault was registered with your Oracle Database 11g, type:

```
SELECT * FROM V$OPTION WHERE PARAMETER = 'Oracle Database Vault';
```

at a SQL*Plus prompt. If the query returns `Oracle Database Vault`, then Oracle Database Vault has been installed and registered. Note that the query is case-sensitive.

If Oracle Database Vault is not registered with your Oracle Database 11g, proceed as follows:

1. Install Oracle Internet Directory as described in *Oracle Fusion Middleware Installation Guide for Oracle Identity Management*.
2. Register Oracle Database Vault as described in *Oracle Database Vault Administrator's Guide*.
3. If the Oracle Database version is 11.1.0.7, download and install the patch for Bug 7244497. This is not necessary for later versions of Oracle Database.
4. If the Oracle Database version is 11.1.0.7, download and install the patch for Bug 7291157. This is not necessary for later versions of Oracle Database.

If Oracle Database Vault was registered with your Oracle Database, proceed as follows:

1. Disable Oracle Database Vault, if it is enabled. See the appendix entitled "Disabling and Enabling Oracle Database Vault" in *Oracle Database Vault Administrator's Guide*.
2. Install Oracle Internet Directory as described in *Oracle Fusion Middleware Installation Guide for Oracle Identity Management*.
3. Enable Database Vault as described in the *Oracle Database Vault Administrator's Guide*.
4. Download and install the patch for Bug 7244497 if you are using Oracle Database 11.1.0.7.
5. Download and install the patch for Bug 7291157 if you are using Oracle Database 11.1.0.7.

Adding a Database Vault Realm and Policies for Oracle Internet Directory

Oracle Internet Directory provides scripts to apply the required Database Vault policies. These scripts are located in the Oracle Internet Directory installation under `$ORACLE_HOME/ldap/datasecurity`.

To apply the Database Vault policies to the Oracle Internet Directory database, you must create the default Database Vault realm for Oracle Internet Directory, as follows:

1. Open `dbv_oid_rule.sql` in a text editor and replace the dummy IP address in the `Check ods connections` and `Check ods connections 2` rules with the IP address of the computer where Oracle Internet Directory is running.
2. Connect to the database as the Database Vault owner and execute `dbv_create_oid_policies.sql`.

The policies in `dbv_create_oid_policies.sql` completely disable SQL*Plus access to the Oracle Internet Directory database. For some tasks, you might require SQL*Plus access to the database by the ODS user. If so, enable SQL*Plus access to the Oracle Internet Directory Database from a specific host or hosts only.

To enable connectivity to the Oracle Internet Directory Database, follow these steps:

1. Open `dbv_oid_rule_sqlplus.sql` in a text editor. Replace the dummy IP address in `Check ods connections 3` rule with the IP addresses of the hosts from which to allow SQL*Plus access to Oracle Internet Directory Database.
2. Connect to the database as the Database Vault owner and execute `dbv_oid_rule_sqlplus.sql`.

If you want to block SQL*Plus access completely to the Oracle Internet Directory database at some point, connect to the Database as the Database Vault owner and execute `dbv_oid_delete_rule_sqlplus.sql`.

Managing Oracle Database Vault Configuration for Oracle Internet Directory

The "Oracle Database Vault Objects" chapter in the *Oracle Database Vault Administrator's Guide* explains how to use data dictionary views. This section describes some views that report Oracle Internet Directory-related information.

The name of the Database Vault realm that Oracle Internet Directory uses is `OID Realm`. You can verify that the realm exists by querying the `DBA_DV_REALM` data dictionary view.

The Database Vault rules defined for Oracle Internet Directory are `Check ods connections`, `Check ods connections 2`, `Check odssm connections`, and `Allow other connections`. If you ran `dbv_oid_rule_sqlplus.sql`, the rule `Check ods connection 3` is also defined. These rules are added to a rule set named `OID App Access`. To check the names of the existing rules, query the `DBA_DV_RULE_SET_RULE` view.

A `CONNECT` command rule is firing this rule set. You can verify this by querying the `DBA_DV_COMMAND_RULE` view. This `CONNECT` rule does not overwrite existing `CONNECT` command rules when you run the Oracle Internet Directory scripts on an existing Oracle Database Vault installation.

Deleting Database Vault Policies For Oracle Internet Directory

To remove the Database Vault policies for OID installed in the prior section, execute `dbv_delete_oid_policies.sql` while connected to the database as the Database Vault Owner.

Disabling Oracle Database Vault for the Oracle Internet Directory Database

See the appendix entitled "Enabling and Disabling Oracle Database Vault" in *Oracle Database Vault Administrator's Guide*.

Best Practices for Using Database Vault with Oracle Internet Directory

The following administrative tasks require special attention when Oracle Database Vault is in use:

- Upgrading Products and Installing Patchsets—disable Oracle Database Vault before performing Oracle Internet Directory or Oracle Database upgrades or patchset installations. Enable Oracle Database Vault again after the upgrade or installation is complete.
- Bulk Loading Data—when Oracle Database Vault is enabled, the SQL*Loader direct path mode is unavailable, which reduces the performance of the `bulkload` tool. Disable Oracle Database Vault before using `bulkload` to load more than 100KB of data or more than one million entries. Enable Oracle Database Vault again after the operation is complete.
- Modifying a Multimaster DRG—before adding or deleting a node in an Oracle Database Advanced Replication-based multimaster directory replication group, disable Oracle Database Vault on that node. Enable Oracle Database Vault again after the operation is complete.

Introduction to Sensitive Attributes

Oracle Internet Directory stores sensitive attributes in an encrypted format. Examples of sensitive attributes are: `orclpasswordattribute`, `orclrevpwd`, the plug-in attribute `orclpluginsecuredflexfield` and the server chaining attribute `orclOIDSCExtPassword`.

List of Sensitive Attributes

The list of sensitive attributes is stored in the attribute `orclencryptedattributes` in the DSA configuration entry. The list is shown in [Table 27-1](#).

Table 27-1 Sensitive Attributes Stored in `orclencryptedattributes`

Sensitive Attribute	Attribute Usage
<code>orclpluginsecuredflexfield</code>	Sensitive attributes passed to a plug-in. See Chapter 43-1 .
<code>orcloidscextpassword</code>	Server admin password for plug-in connection. See Chapter 43-1 .
<code>orcloidswalletpassword</code>	Plug-in sslwallet password. See Chapter 37
<code>orclrevpwd</code>	User password in reversible encrypted format. See Chapter 30 .
<code>orclunsyncrevpwd</code>	Encrypted reversible password NOT synchronized with the related <code>userpassword</code> . See Chapter 30 .
<code>orclodipprofileinterfaceconnectioninformation</code>	Oracle Directory Integration Platform: Information used to connect to an application for event propagation.
<code>orclodipcondiraccesspassword</code>	Oracle Directory Integration Platform: Used by third-party directory to connect to directory.
<code>orclodipagentpassword</code>	Oracle Directory Integration Platform: Password that the synchronization profile uses to bind to the directory.

For information about the last three entries, see the "Attribute Reference" chapter in *Oracle Fusion Middleware Reference for Oracle Identity Management*.

The `orcldataprivacymode` attribute controls whether these attributes are encrypted when the data is received. When `orcldataprivacymode` is enabled, the sensitive attributes are encrypted. When privacy mode is disabled, the sensitive data is returned in the clear.

Note: This list should not be modified. Do not attempt to add sensitive attributes.

Encryption Algorithm for Sensitive Attributes

Prior to 11g Release 1 (11.1.1.4.0), Oracle Internet Directory used the 3DES encryption algorithm for the storage of sensitive attributes. As of 11g Release 1 (11.1.1.4.0), Oracle Internet Directory uses AES-256.

Customers who have patched their systems from an earlier release might already have stored values encrypted with the 3DES algorithm. In such cases, the following rules apply:

- At decryption time, Oracle Internet Directory uses the appropriate algorithm (3DES or AES-256) to decrypt the value.
- At encryption time, Oracle Internet Directory always encrypts using AES-256.

This ensures that, over time, all encrypted values are converted to AES-256.

Configuring Privacy of Retrieved Sensitive Attributes

Privacy mode is disabled by default. That is, the value of `orcldataprivacymode` is 0. To provide security protection, you must enable privacy mode by changing the value of `orcldataprivacymode` from 0 to 1 in the DSA configuration entry

To determine the value of `orcldataprivacymode`, perform the following search:

```
$ORACLE_HOME/bin/ldapsearch -h host -p port -D cn=orcladmin -q \
  -b "cn=dsaconfig,cn=configsets,cn=oracle internet directory" -s base \
  "objectclass=*" orcldataprivacymode
```

To enable privacy mode, use an LDIF file containing the following entries:

```
dn: cn=dsaconfig,cn=configsets,cn=oracle internet directory
changetype: modify
replace: orcldataprivacymode
orcldataprivacymode: 1
```

Load the LDIF file with a command line similar to this:

```
$ORACLE_HOME/bin/ldapmodify -h host -p port -D cn=orcladmin -q -v \
  -f LDIF_file_name
```

Introduction to Hashed Attributes

Unlike encryption, hashing is a one-way operation. It is not possible to derive the original value from the hashed value. Oracle Internet Directory supports hashed attributes in addition to sensitive attributes. The list of hashed attributes is contained in `orclhashedattributes`, a multivalued attribute of the DSA configuration entry. Hashing is performed using the cryptographic scheme set in the root DSE attribute `orclcryptoscheme`.

LDAP operations and `bulkload` automatically perform the transformations described in [Table 27-2](#). You cannot use the `bulkmodify` command with hashed attributes.

Table 27-2 LDAP and Bulk Operations on Attributes in `orclhashedattributes`

Operation	When incoming attribute value is already hashed	When incoming attribute value is not yet hashed
<code>ldapadd</code>	Use value as it is.	Hash incoming value by using <code>orclcryptoscheme</code> before performing operation.
<code>ldapmodify</code>	Use value as it is.	For an add or replace operation, hash incoming value by using <code>orclcryptoscheme</code> before performing operation. For a delete operation, hash the incoming value using the cryptographic scheme that was in use at the time the attribute was stored in the directory before performing operation.

Table 27–2 (Cont.) LDAP and Bulk Operations on Attributes in orclhashedattributes

Operation	When incoming attribute value is already hashed	When incoming attribute value is not yet hashed
ldapcompare	Compare incoming value with value stored in directory.	Hash the incoming value by using the crypto scheme that was in use at the time the attribute was stored in the directory and then compare it with the stored value.
bulkload	Use value as it is.	Hash incoming value by using orclcryptoscheme before performing operation.
bulkmodify	Do not allow bulkmodify.	Do not allow bulkmodify.

Notes:

- Never include the same attribute in both orclhashedattributes and orclencryptedattributes.
- Only single-valued attributes can be hashed attributes.

Configuring Hashed Attributes

You can manage the list of attributes in `orclhashedattributes` by using Oracle Enterprise Manager Fusion Middleware Control or the command line.

Configuring Hashed Attributes by Using Fusion Middleware Control

You can configure hashed attributes by using the Shared Properties page in Oracle Enterprise Manager Fusion Middleware Control.

Select **Administration**, then **Shared Properties** from the **Oracle Internet Directory** menu.

Configuring Hashed Attributes by Using ldapmodify

To configure hashed attributes by using the command line, add the attribute names to the DSA configuration entry's multivalued attribute `orclhashedattribute`.

For example, the following LDIF file adds three attributes to `orclhashedattributes`.

```
dn: cn=dsconfig,cn=configsets,cn=oracle internet directory
changetype:modify
add: orclhashedattributes
orclhashedattributes: attributeName1
orclhashedattributes: attributeName2
orclhashedattributes: attributeName3
```

Load the LDIF file with a command line similar to this:

```
$ORACLE_HOME/bin/ldapmodify -h host -p port -D cn=orcladmin -q -v \
-f LDIF_file_name
```

Managing Password Policies

Password policies are sets of rules that govern how passwords are used. This chapter contains these topics:

- [Introduction to Managing Password Policies](#)
- [Managing Password Policies by Using Oracle Directory Services Manager](#)
- [Managing Password Policies by Using Command-Line Tools](#)

Note: All references to Oracle Delegated Administration Services in this chapter refer to Oracle Delegated Administration Services 10g (10.1.4.3.0) or later.

Introduction to Managing Password Policies

A password policy is a set of rules governing how passwords are used. When a user attempts to bind to the directory, the directory server ensures that the password meets the various requirements set in the password policy.

When you establish a password policy, you set the following types of rules, to mention just a few:

- The maximum length of time a given password is valid
- The minimum number of characters a password must contain
- The number of numeric characters required in a password

This section contains these topics:

- [What a Password Policy Is](#)
- [Fine-Grained Password Policies](#)
- [Default Password Policy](#)
- [Password Policy Attributes](#)
- [Directory Server Verification of Password Policy Information](#)

What a Password Policy Is

Password policies are sets of rules that govern password syntax and how passwords are used. Password policies enforced by Oracle Internet Directory include:

- The maximum length of time a given password is valid
- The minimum number of characters a password must contain

- The minimum number of numeric characters required in a password
- The minimum number of alphabetic characters
- The minimum number of repeated characters
- The use of uppercase and lowercase
- The minimum number of non-alphanumeric characters (that is, special characters)
- That users change their passwords periodically
- The minimum and maximum time between password changes
- The grace period for logins after password expiration, by time or by number of logins
- That users cannot reuse previously used passwords

Steps Required to Create and Apply a Password Policy

In general, establishing a password policy requires the following steps:

1. Create a password policy entry in the appropriate container and associate it with the `pwdpolicy` object. (Default entries exist when you first install Oracle Internet Directory.)
2. Create the desired policy by setting values for attributes defined under the `pwdpolicy` object class for the entry created in step 1.
3. Enable the policy by setting the `orclpwdpolicynable` attribute to 1. If this is not set to 1, Oracle Internet Directory ignores the policy.
4. Determine the subtree to be governed by the policy. Add and populate a `pwdpolicysubentry` attribute with the policy's DN, at the root of that subtree.

See Also: "Object Class Reference" in *Oracle Fusion Middleware Reference for Oracle Identity Management* for a list and descriptions of the attributes of the `pwdPolicy` object class, and those of the `top` object class that pertain to password policies

Fine-Grained Password Policies

In 10g (10.1.4.0.1) and later, Oracle Internet Directory supports multiple password policies in each realm. You can apply these policies to any subtree within that realm. This means that you can have entry-specific password policies.

You can specify password policies as realm-specific or directory-wide in scope. To achieve the desired scope, you must create the password policy entry in the appropriate container. Password policies are populated under a "cn=pwdPolicies" container created under the "cn=common" entry in each realm. By default these containers contain a password policy with the RDN "cn=default". The directory specific default password policy, for example, has the DN:

```
cn=default,cn=pwdPolicies,cn=Common,cn=Products,cn=OracleContext.
```

You can create other policies under the `pwdPolicies` container, with different RDNs. [Figure 28-1](#) illustrates this scenario.

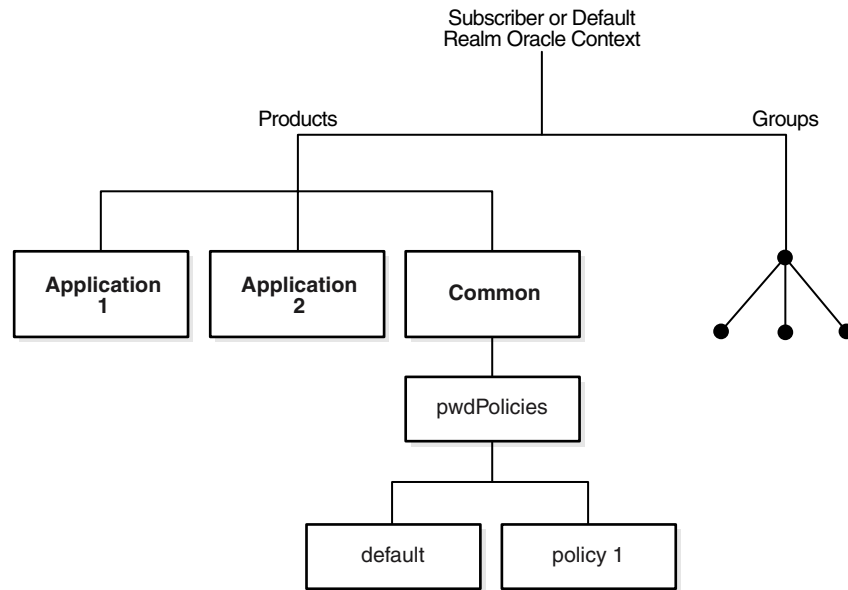
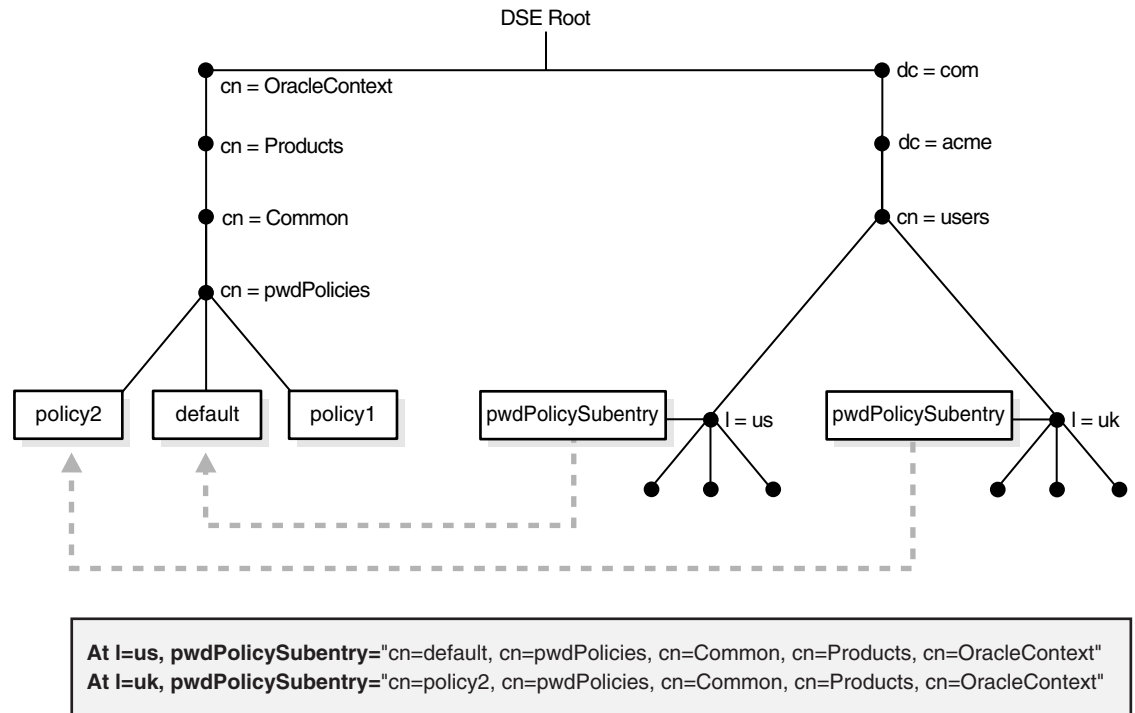
Figure 28-1 Location of Password Policy Entries**Figure 28-2 pwdPolicy subentry Attributes Populated with DN of Password Policy**

At run time, Oracle Internet Directory resolves the applicable password policy on an entry by looking for a populated `pwdpolicysubentry` attribute in the entry and applying the policy pointed to by its value. If a populated `pwdPolicysubentry` attribute does not exist, Oracle Internet Directory traverses up the directory tree until it finds the nearest ancestor entry with a populated `pwdPolicysubentry`. Oracle Internet Directory applies the password policy pointed to by the value at that entry.

Notes:

- You can disable a password policy by setting `orclpwdpolicyenable` to 0. Doing so leaves that portion of the directory without an applicable password policy. Oracle Internet Directory does not traverse up the DIT to find an enabled policy that is applicable. Setting this attribute to 0 enables you to leave portions of the directory free of password policies when necessary. However you should consider the implications of making such a change before doing so.
 - You must protect password policy entries from anonymous access using Oracle Internet Directory's ACI infrastructure, described in [Chapter 29, "Managing Directory Access Control"](#). This is particularly important when a password policy is weak, as that information can assist an attacker in compromising the directory.
-

Default Password Policy

The default password policy for Oracle Internet Directory enforces:

- Password expiration in 120 days
- Account lockout after 10 login failures. Except for the superuser account, all accounts remain locked for a duration of 24 hours unless the passwords are reset by the directory administrator. A user account stays locked even after the lockout duration has passed unless the user binds with the correct password

If the superuser account, `cn=orcladmin`, becomes locked, it stays locked until you unlock it by using the OID Database Password utility. This utility prompts you for the ODS user password. After you enter the ODS password, it unlocks the account.

See Also:

- The `oidpasswd` command-line tool reference in *Oracle Fusion Middleware Reference for Oracle Identity Management* for information on unlocking a superuser account
- ["Troubleshooting Password Policies"](#) on page R-9.
- A minimum password length of five characters with at least one numeric character
- Password expiry warning seven days before expiry
- Five grace logins allowed after password expiry

Beginning in Oracle Internet Directory, Release 9.0.4, the password policy entry in the Root Oracle Context applies to the superuser, but only the password policy governing account lockout is enforced on that account.

Note: Oracle Identity Management has two distinct types of privileged user. Both privileged user accounts can be locked if certain password policies are activated.

The first type of privileged user, the superuser with the DN `cn=orcladmin`, is represented as a special user entry found within the default identity management realm. It enables directory administrators to make any modifications to the DIT and any changes to the configuration of Oracle Internet Directory servers. If the superuser (`orcladmin`) account is locked—for example, as a result of too many attempts to bind with an incorrect password—then an administrator with DBA privileges to the Oracle Internet Directory repository can unlock it by using the `oidpasswd` tool. To unlock the `orcladmin` account execute the command:

```
oidpasswd unlock_su_acct=TRUE
```

The second privileged user, a realm-specific privileged user, governs capabilities such as creation and deletion of users and groups within a realm and all the functionality related to Oracle Delegated Administration Services. This account is represented by an entry with the DN `cn=orcladmin,cn=users, realm DN`. Note that, in contrast to the single superuser account, each realm has its own realm-specific privileged user. To unlock the realm-specific privileged account, the first type of privileged user, `cn=orcladmin`, can modify the account password by using Oracle Directory Services Manager.

The Oracle Internet Directory password policy is applicable to simple binds (based on the `userpassword` attribute), compare operations on the `userpassword` attribute, and SASL binds. It does not apply to SSL and proxy binds.

Password Policy Attributes

The following attributes affect password policy:

Table 28–1 Password Policy Attributes

Name	Function
<code>pwdMinAge</code>	The number of seconds that must elapse between user modifications to the password. The default is 0.
<code>pwdMaxAge</code>	The maximum time, in seconds, that a password can be valid. Upon reaching this age, the password is considered to have expired. The default is 10368000 seconds (120 days).
<code>pwdLockout</code>	When this is true, the server locks out a user after a number of consecutive invalid login attempts. The number is specified by <code>pwdMaxFailure</code> . The default value of <code>pwdLockout</code> is 1 (true).
<code>orclpwdIPLockout</code>	When this is true, the server locks out a user after a number of consecutive invalid login attempts from the same IP address. The number is specified by <code>orclpwdIPMaxFailure</code> . The default is false.
<code>pwdLockoutDuration</code>	The time period in seconds to lock out a user account when the threshold of invalid login attempts is reached. The default is 86400 seconds (24 hours).

Table 28–1 (Cont.) Password Policy Attributes

Name	Function
<code>orclpwdIPLockoutDuration</code>	The time period in seconds to lock out a user account when the threshold of invalid login attempts from the same IP address is reached. The default is 0.
<code>pwdMaxFailure</code>	The maximum number of invalid login attempts the server should allow before locking out a user account. The default value is 10.
<code>orclpwdIPMaxFailure</code>	The maximum number of invalid login attempts the server should allow from a particular IP address before locking the user account. The default is 0.
<code>pwdFailureCountInterval</code>	The time in seconds after which the password failures are purged from the failure counter, even though no successful authentication occurred. The default is 0.
<code>pwdExpireWarning</code>	The maximum number of seconds before a password is due to expire that expiration warning messages are returned to an authenticating user. The default value is 604800 seconds (seven days).
<code>pwdCheckSyntax</code>	Enables or disables password syntax check 0–Disable all syntax checks 1–Enable password syntax value checks, except for encrypted passwords (default)
<code>pwdMinLength</code>	The minimum length of a password governed by this policy. The default is 5 characters
<code>pwdGraceLoginLimit</code>	The maximum number of grace logins allowed after a password expires. The default is 5. The maximum is 250.
<code>orclpwdGraceLoginTimeLimit</code>	The maximum period in seconds where grace logins are allowed after a password expires. If <code>orclpwdGraceLoginTimeLimit</code> is nonzero, then <code>pwdGraceLoginLimit</code> must be zero. If <code>pwdGraceLoginLimit</code> is nonzero, then <code>orclpwdGraceLoginTimeLimit</code> must be zero (the default).
<code>pwdMustChange</code>	Requires users to reset their password upon their first login after account creation or after a password has been reset by the administrator. The default is 0 (false).
<code>orclpwdIllegalValues</code>	A list of values that are not allowed as passwords.
<code>orclpwdAlphaNumeric</code>	The minimum number of numeric characters required in a password. The default is 1.
<code>orclpwdMinAlphaChars</code>	The minimum number of alphabetic characters required in a password. The default is 0.
<code>orclpwdMinSpecialChars</code>	The minimum number of non-alphanumeric characters (that is, special characters) required in a password. The default is 0.
<code>orclpwdMinUppercase</code>	The minimum number of uppercase characters required in a password. The default is 0.
<code>orclpwdMinLowercase</code>	The minimum number of lowercase characters required in a password. The default is 0.
<code>orclpwdMaxRptChars</code>	The maximum number of repeated characters allowed in a password. The default is 0.
<code>pwdInHistory</code>	The maximum number of used passwords stored in the <code>pwdHistory</code> attribute of a given entry. Passwords stored in <code>pwdHistory</code> cannot be used as a new password until they are purged from it. The default is 0.

Table 28–1 (Cont.) Password Policy Attributes

Name	Function
pwdAllowUserChange	Not currently used.
orclpwdPolicyEnable	When this is true, the server evaluates this policy. Otherwise, the policy is ignored and not enforced. The default is 1 (true).
orclpwdEncryptionEnable	When set to true, enables password encryption. The default is 0 (false).
orclpwdAllowHashCompare	Enables or disables logins using the hashed password value. 0 = disabled (default). 1 = enabled.
orclPwTrackLogin	Enables or disables tracking of user's last login time. 0 = disabled (default). 1 = enabled.
orclPwMaxInactivity	Amount of inactive time, in seconds, before an account is automatically expired. 0=disabled (default). The attribute orclPwTrackLogin must be enabled if orclPwMaxInactivity is non-zero.

Password Policy-Related Operational Attributes

The Oracle Internet Directory server stores user-specific password policy-related information in operational attributes of the user entry. Only the server can modify these attributes. They are shown in [Table 28–2](#).

Table 28–2 Password Policy-Related Operational Attributes

Attribute	Description
orcllastlogintime	Timestamp of last successful login. Tracked only if the password policy attribute orclPwTrackLogin is enabled.
pwdfailuretime	A space-delimited set of timestamps of failed login attempts, cleared upon successful login.
orclpwdipaccountlocketime	Time when account was locked for logins from this IP address. This can be a multivalued attribute.
orclpwdipfailuretime	A space-delimited set of timestamps of failed login attempts from a specific IP address, cleared upon successful login. This can be a multivalued attribute.
pwdaccountlockedtime	Time when account was locked.
pwdchangedtime	Time of last password change.
pwdexpirationwarned	Time when user was warned of password expiration.
pwdgraceusetime	A space-delimited set of timestamps of logins during the grace period.
pwdreset	If the value is 1, the user must reset the password at the next login.
pwdhistory	List of previously used passwords.

To determine the last login attempt, compare `orcllastlogintime` with the last timestamp in `pwdfailuretime`. The most recent of these is the time of the last login attempt.

Directory Server Verification of Password Policy Information

As explained in "[Fine-Grained Password Policies](#)" on page 28-2, Oracle Internet Directory determines the applicable policy for an entry by locating the appropriate

populated `pwdPolicySubentry`. To ensure that the user password meets the requirements of a given policy, the directory server verifies:

- That the password policy is enabled. It does this by checking the value of the attribute `orclpwdpolicyenable` in the password policy entry. A value of 1 indicates that the password policy is enabled. A value of 0 indicates that it is disabled.
- Correctness of password policy syntax information, which includes, for example, the correct number of alphabetic and numeric characters, or the correct password length. The directory server checks the syntax during `ldapadd` and `ldapmodify` operations on the `userpassword` attribute.
- Password policy state information, which, for example, includes:
 - The timestamp of the user password creation or modification
 - That the minimum password age is greater than the current time minus the time of password creation
 - The timestamp of consecutive failed login attempts by the user
 - The time at which the user account was locked
 - Indicator that the password has been reset and must be changed by the user on first authentication
 - A history of user's previously used passwords
 - Time stamps of grace logins

If the grace login is set by time period, the server checks the time discrepancy between the current time and the expiration.

The directory server checks the state information during `ldapbind` and `ldapcompare` operations, but does so only if the `orclpwdpolicyenable` attribute is set to 1.

To enable password value syntax checking, set the attributes `orclpwdpolicyenable` and `pwdchecksyntax` in the password policy entry to `TRUE`.

Password Policy Error Messages

Whenever there are password policy violations, the directory server sends to the client various error and warning messages. In Oracle Internet Directory, 10g (10.1.4.0.1) or later, the directory server can send these messages as LDAP controls only if the client sends a password policy request control as a part of an LDAP bind or compare operation. If the client does not send the request control, then the directory server does not send the response controls. Instead, it sends errors and warnings as part of additional information.

See: ["Troubleshooting Password Policies"](#) on page R-9 for a list of the messages and information about how to resolve them

Releases Before 10g (10.1.4.0.1)

In releases before 10g (10.1.4.0.1), password policies were controlled by the `orclcommonusersearchbase` attribute in a realm-specific Common Entry. If you upgraded from an earlier release, the existing password policies were migrated to the new architecture during the upgrade. With the new architecture, simply adding a DN

to the `orclcommonusersearchbase` no longer guarantees that the realm's default password policy is applied to the subtree rooted at that DN.

In Oracle Internet Directory 10g (10.1.4.0.1) and later, when you define a password policy, you must perform a second step to apply the password policy to a subtree of the directory. You must populate the `pwdPolicySubentry` attribute with the DN of the desired password policy on an entry that is the root of a subtree you want the policy to be applicable to. [Figure 28–2](#) illustrates this. The `pwdPolicy` at `l=us` contains the DN of the default policy, `"cn=default,cn=pwdPolicies,cn=Common,cn=Products,cn=OracleContext"`, so the default policy applies to the users in the US. The `pwdPolicySubentry` at `l=uk` contains the DN of the policy `"cn=policy2,cn=pwdPolicies,cn=Common,cn=Products,cn=OracleContext"`, so `policy2` applies to the users in the UK.

Note: Password policy entries for subtrees and users are replicated. Replicating the 11g Release 1 (11.1.1) or 10g (10.1.4.0.1) policies to a pre-10g (10.1.4.0.1) node does not adversely impact the functionality of that node. A pre-10g (10.1.4.0.1) node, however, cannot meaningfully interpret the new password policies. It continues to enforce the password policy in the realm Oracle context.

Managing Password Policies by Using Oracle Directory Services Manager

You can use Oracle Directory Services Manager to create, assign, and modify password policies.

This section contains these topics:

- [Viewing Password Policies by Using Oracle Directory Services Manager](#)
- [Modifying Password Policies by Using Oracle Directory Services Manager](#)
- [Creating a Password Policy and Assigning it to a Subtree by Using ODSM](#)

Viewing Password Policies by Using Oracle Directory Services Manager

1. Invoke Oracle Directory Services Manager and connect to the Oracle Internet Directory server as described in ["Invoking Oracle Directory Services Manager"](#) on page 7-9.
2. From the task selection bar, select **Security**.
3. Expand **Password Policy** in the left pane. All of the password policies appear in the left pane, listed by relative DN. Mouse over an entry to see the full DN.
4. Select a password policy to display its information in the right pane.

Modifying Password Policies by Using Oracle Directory Services Manager

To modify the password policies:

1. Invoke Oracle Directory Services Manager and connect to the Oracle Internet Directory server as described in ["Invoking Oracle Directory Services Manager"](#) on page 7-9.
2. From the task selection bar, select **Security**.
3. Expand **Password Policy** in the left pane. All of the password policies appear in the left pane.

4. Select the password policy you want to modify. Five tab pages appear in the right pane.
5. In the **General** tab page, modify the editable attribute fields as needed.
6. Select the **Account Lockout** tab page and, to modify the fields, select **Global Lockout**. Modify the editable attribute fields as needed.
7. Select the **IP Lockout** tab page and, to modify the fields, select **IP Lockout**. Modify the editable attribute fields as needed.
8. Select the **Password Syntax** tab page and, to modify the fields, select **Check Password Syntax**. Modify the editable attribute fields as needed.
9. Select the **Effective Subtree** tab page to modify the subtree to which the policy applies. To add a subtree, select the **Add** icon. Either enter the DN, or select **Browse**, then use the **Select Distinguished Name (DN) Path** window to navigate to the subtree to which you want the policy to apply.
10. When you are finished, choose **Apply**.

Creating a Password Policy and Assigning it to a Subtree by Using ODSM

To create a new password policy:

1. Invoke Oracle Directory Services Manager and connect to the Oracle Internet Directory server as described in "[Invoking Oracle Directory Services Manager](#)" on page 7-9.
2. From the task selection bar, select **Security**.
3. Expand **Password Policy** in the left pane. All of the password policies appear in the left pane.
4. To create a new policy, select **Create**. Alternatively, select an existing password policy in the left pane and select **Create Like**.
5. In the **General** tab page, set or modify the editable attribute fields as needed.
6. Select the **Account Lockout** tab page and, to modify the fields, select **Global Lockout**. Modify the editable attribute fields as needed.
7. Select the **IP Lockout** tab page and, to modify the fields, select **IP Lockout**. Modify the editable attribute fields as needed.
8. Select the **Password Syntax** tab page and, to modify the fields, select **Check Password Syntax**. Modify the editable attribute fields as needed.
9. To assign the password policy to a subtree, select the **Effective Subtree** tab page, then select **Add**. Either enter the DN, or select **Browse**, then use the **Select Distinguished Name (DN) Path** window to navigate to the subtree to which you want the policy to apply.
10. When you are finished, choose **Apply**.

Managing Password Policies by Using Command-Line Tools

This section contains these topics:

- [Viewing Password Policies by Using Command-Line Tools](#)
- [Creating a New Password Policy by Using Command-Line Tools](#)
- [Applying a Password Policy to a Subtree by Using Command-Line Tools](#)

- [Setting Password Policies by Using Command-Line Tools](#)

Viewing Password Policies by Using Command-Line Tools

The following example retrieves password policies under a specific password policy container:

```
ldapsearch -p port -h host \
  -b "cn=pwdPolicies,cn=common,cn=products,cn=OracleContext, \
    o=my_company,dc=com" \
  -s sub "(objectclass=pwdpolicy)"
```

The following example retrieves all password policy entries:

```
ldapsearch -p port -h host -b " " -s sub "(objectclass=pwdpolicy)"
```

Creating a New Password Policy by Using Command-Line Tools

You create a new password policy by adding a policy entry to the appropriate container. A good way to do this is as follows:

1. Dump the contents of the default entry, `cn=default, cn=pwdPolicies, cn=Common, cn=Products, cn=OracleContext`, to an LDIF file, using `ldapmodify`. For example:

```
ldapsearch -p port -h host -D cn=orcladmin -q -L \
  -b 'cn=default,cn=pwdPolicies,cn=Common,cn=Products, cn=OracleContext' \
  -s base '(objectclass=pwdpolicy)' >> pwdpolicy.ldif
```

As an alternative to `ldapsearch`, you could use `ldifwrite`. Ensure `ORACLE_INSTANCE` is set, then type:

```
ldifwrite connect="conn_str" \
  baseDN="cn=default,cn=pwdPolicies,cn=Common,cn=Products, cn=OracleContext" \
  ldiffile="pwdpolicy.ldif"
```

2. Modify the LDIF file so that it has the common name and desired values for the new policy. For example, you might change `cn=default` to `cn=policy1` and change `pwdMaxFailure` from 10 to 5.
3. Add the new entry by using `ldapadd`. You would use a command line of the form:

```
ldapadd -p port_number -h host -D cn=orcladmin -q -f pwdpolicy.ldif
```

Applying a Password Policy to a Subtree by Using Command-Line Tools

To apply the new password policy to the subtree `"dn: cn=accounting,c=us"` you would use a command line such as:

```
ldapmodify -D "cn=orcladmin" -q -p port -h host -f my_file.ldif
```

with an LDIF file such as this:

```
dn: cn=accounting,c=us
changetype: modify
replace: pwdPolicysubentry
pwdPolicysubentry:cn=policy1,cn=pwdPolicies,cn=common,cn=products,
cn=OracleContext,o=my_company,dc=com
```

Setting Password Policies by Using Command-Line Tools

The following example disables the `pwdLockout` attribute in the default password policy. It changes the attribute from its default setting of 1 to 0.

The file `my_file.ldif` contains:

```
dn: cn=default,cn=pwdPolicies,cn=common,cn=products,cn=OracleContext,  
o=my_company,dc=com  
changetype:modify  
replace: pwdlockout  
pwdlockout: 0
```

The following command loads this file into the directory:

```
ldapmodify -D "cn=orcladmin" -q -p port -h host -f my_file.ldif
```

The following example modifies `pwdMaxAge` in the default password policy entry.

```
ldapmodify -D "cn=orcladmin" -q -p port -h host -q -f file
```

where *file* contains:

```
dn: cn=default,cn=pwdPolicies,cn=common,cn=products,cn=OracleContext,  
o=my_company,dc=com  
changetype: modify  
replace: pwdMaxAge  
pwdMaxAge: 10000
```

Managing Directory Access Control

This chapter provides an overview of access control policies and describes how to administer directory access control by using either Oracle Directory Services Manager or the command-line tool, `ldapmodify`.

This chapter contains these topics:

- [Introduction to Managing Directory Access Control](#)
- [Managing Access Control by Using Oracle Directory Services Manager](#)
- [Managing Access Control by Using Command-Line Tools](#)

See Also:

- ["Security"](#) on page 3-14 and [Chapter 32, "Managing Authentication"](#) for a conceptual explanation before you begin implementing and administering access control policies
- [Appendix H, "The Access Control Directive Format"](#) for information about the format or syntax of Access Control Items (ACIs)

Introduction to Managing Directory Access Control

Authorization is the permission given to a user, program, or process to access an object or set of objects. When directory operations are attempted within a directory session, the directory server ensures that the user has the permissions to perform those operations. If the user does not have the permissions, then the directory server disallows the operation. The directory server protects directory data from unauthorized operations by directory users by using access control information.

Access control information is the directory metadata that captures the administrative policies relating to access control. This information is stored in Oracle Internet Directory as user-modifiable configuration attributes, each of which is called an access control item (A CI).

Typically, a list of these ACI attribute values, called an access control list (ACL), is associated with directory objects. The attribute values on that list represent the permissions that various directory user entities (or subjects) have on a given object.

An ACI consists of:

- The object to which you are granting access
- The entities or subjects to whom you are granting access
- The kind of access you are granting

Access control policies can be prescriptive, that is, their security directives can be set to apply downward to all entries at lower positions in the directory information tree (DIT). The point from which such an access control policy applies is called an access control policy point (ACP).

ACIs are represented and stored as text strings in the directory. These strings must conform to a well-defined format, called the ACI directive format. Each valid value of an ACI attribute represents a distinct access control policy.

The following features of directory access control can be used by applications running in a hosted environment.

- Prescriptive access control
 - Enables the service provider to specify access control lists (ACLs) for a collection of directory objects, instead of having to state the policies for each individual object. This feature simplifies the administration of access control, especially in large directories where many objects are governed by identical or similar policies.
- Hierarchical access control administration model
 - Enables the service provider to delegate directory administration to hosted companies. The realm could in turn delegate further if necessary.
- Administrative override control for delegated domains
 - Enables the service provider to perform diagnosis and recovery from unintentional account lockout or accidental security exposure.
- Dynamic evaluation of access control entities
 - Enables subtree administrators to identify both subjects and objects in terms of their namespace and their association with other objects in the directory. For example, the administrator of one realm can allow only a user's manager to update that user's salary attribute. The administrator of another realm can establish and enforce a different policy regarding salary attributes.

You manage access control policies by configuring the values of the ACI attributes within appropriate entries. You can do this by using either Oracle Directory Services Manager or `ldapmodify`.

This section contains these topics:

- [Access Control Management Constructs](#)
- [Access Control Information Components](#)
- [Access Level Requirements for LDAP Operations](#)

Access Control Management Constructs

This section discusses the structures used for access control in Oracle Internet Directory. These include:

- Access Control Policy Points (ACPs)
- The `orclACI` attribute for prescriptive access control
- The `orclEntryLevelACI` attribute for entry-level access control
- Privilege Groups

Access Control Policy Points (ACPs)

ACPs are entries in which the `orclACI` attribute has been given a value. The `orclACI` attribute value represents the access policies that are inherited by the subtree of entries starting with the ACP as the root of the subtree.

When a hierarchy of multiple ACPs exists in a directory subtree, a subordinate entry in that subtree inherits the access policies from all of the superior ACPs. The resulting policy is an aggregation of the policies within the ACP hierarchy above the entry.

For example, if an ACP is established in the HR department entry, and the Benefits, Payroll, and Insurance groups are entries within the HR department, then any entry within those groups inherits the access rights specified in the HR department entry.

When there are conflicting policies within a hierarchy of ACPs, the directory applies well-defined precedence rules in evaluating the aggregate policy.

See Also: ["How ACL Evaluation Works"](#) on page 29-12

The `orclACI` Attribute for Prescriptive Access Control

The `orclACI` attribute contains access control list (ACL) directives that are prescriptive—that is, these directives apply to all entries in the subtree below the ACP where this attribute is defined. Any entry in the directory can contain values for this attribute. Access to this attribute itself is controlled in the same way as access to any other attribute.

Note: It is possible to represent ACL directives specific to a single entry in the `orclACI` attribute. However, in such scenarios, for administrative convenience and performance advantages, Oracle recommends using `orclEntryLevelACI`—discussed in ["The `orclEntryLevelACI` Attribute for Entry-Level Access Control"](#). This is because the LDAP configuration overhead increases with the number of directives represented through `orclACI`. You can reduce this overhead by moving entry specific directives from `orclACI` to `orclEntryLevelACI`.

The `orclEntryLevelACI` Attribute for Entry-Level Access Control

When a policy pertains only to a specific entity—for example, a special user—you can maintain the ACL directives within the entry for that entity. You do this by using a user-modifiable configuration attribute called `orclEntryLevelACI`. This attribute contains ACL directives only for the entry with which it is associated.

Any directory entry can optionally carry a value for this attribute. This is because Oracle Internet Directory extends the abstract object class `top` to include `orclEntryLevelACI` as an optional attribute.

The `orclEntryLevelACI` attribute is multi-valued and has a structure similar to that of `orclACI`.

See Also: ["Object: To What Are You Granting Access?"](#) on page 29-7 for the structure definition of the `orclEntryLevelACI` attribute

Security Groups

Group entries in Oracle Internet Directory are associated with either the `groupOfNames` or the `groupOfUniqueNames` object class. Membership in the group is specified as a value of the `member` or `uniqueMember` attribute respectively.

To specify access rights for a group of people or entities, you identify them in security groups. There are two types of security groups: ACP groups and privilege groups.

ACP groups If an individual is a member of an ACP group, then the directory server simply grants to that individual the privileges associated with that ACP group.

Use ACP groups to resolve access at the level of an ACP. For example, suppose you want to give to several hundred users access to browse an entry. You could assign the browse privilege to each entry individually, but this could require considerable administrative overhead. Moreover, if you later decide to change that privilege, you would have to modify each entry individually. A more efficient solution is to assign the privilege collectively. To do this, you create a group entry, designate it as an ACP group, assign the desired privilege to that group, then assign users as members of that group. If you later change the access rights, you must do it in one place, for the group, rather than for each individual user. Similarly, you can remove that privilege from multiple users by removing them from the group, rather than having to access multiple individual entries.

ACP groups are associated with the `orclacpgroup` object class.

Privilege Groups A privilege group is a higher-level access group. It is similar to an ACP group in that it lists users with similar rights. However, it also provides for additional checking beyond a single ACP, as follows: if an ACP denies access, an attribute in the user's entry tells the directory server whether the user being denied is in any privilege group. If so, then this user has additional rights at a higher administration level, and all higher administration levels in the DIT are checked. If the directory server finds a higher ACP that grants to the privilege group access to the requested object, then it overrides the denials by the subordinate ACP, and grants access to the user. If, however, the `orclACI` or `orclEntryLevelACI` attribute of a subordinate ACP contains the keyword `DenyGroupOverride`, the higher level ACP does not override the subordinate ACP. Use `DenyGroupOverride` to restrict superuser access through privileged groups.

Normally, you would implement only ACP groups. The additional checking that privilege groups provide can degrade performance. Use privilege groups only when access control at higher levels needs the right to override standard controls at lower levels.

Use privilege groups to grant access to administrators who are not recognized by ACPs lower in the DIT. For example, suppose that the global administrator in a hosted environment must perform operations in a realm. Because the global administrator's identity is not recognized in the realm of the hosted company, the directory server, relying only on the ACPs in that realm, denies the necessary access. However, if the global administrator is a member of a privilege group, then the directory server looks higher in the DIT for an ACP that grants to this privilege group the access rights to that subtree. If it finds such an ACP, then the directory server overrides the denials by ACPs in the hosted company's realm.

Add the `DenyGroupOverride` keyword to an ACI to deny access to members of privileged groups.

Privilege groups are associated with the `orclPrivilegeGroup` object class.

Users in Both Types of Groups If a user is a member of both an ACP group and a privilege group, then the directory server performs an evaluation for each type of group. It resolves access rights for the privilege group by looking to ACPs higher in the DIT.

Constraints on Security Groups Do not create a security group that is of both object classes `orclacpgroup` and `orclPrivilegeGroup`.

In nested security groups, the parent group and child group must always be of the same objectclass either `orclacpgroup` or `orclPrivilegeGroup`.

Violating either of these constraints can result in non-deterministic ACI evaluation.

Overview: Granting Access Rights to a Group To grant access rights to a group of users, you do the following:

1. Create a group entry in the usual way.
2. Associate the group entry with either the `orclPrivilegeGroup` object class or the `orclACPgroup` object class.
3. Specify the access policies for that group.
4. Assign members to the group.

How the Directory Server Computes Security Group Membership Entries can have either direct memberships in groups, or indirect memberships in other ACP or privilege groups by means of nested groups, thus forming a forest of privilege groups. Access policies specified at a given level are applicable to all the members directly or indirectly below that level.

Because Oracle Internet Directory evaluates for access control purposes only security groups, it does not allow setting access policies for other types of groups. When a user binds with a specific distinguished name (DN), Oracle Internet Directory computes the user's direct membership in security groups. If it knows the first level groups for the given DN, Oracle Internet Directory computes nesting of all these first level groups into other security groups. This process continues until there are no more nested groups to be evaluated.

Each security group, nested or otherwise, must be associated with a security group object class—either `orclACPgroup` or `orclPrivilegeGroup`. Even if a group is a member of a security group, the directory server does not consider it for access control purposes unless it is associated with a security group object class. When it has determined the user's membership in security groups, the directory server uses that information for the lifetime of the session.

Example: Computing Security Group Membership For example, consider the sample group of entries in [Table 29-1](#), each of which, except Group 4, is marked as a privilege group (objectclass:`orclprivilegegroup`). You can set access control policies that apply to the members of `group1`, `group2`, and `group3`.

Table 29–1 Sample Security Groups

Group	Entry
Group 1	dn: cn=group1,c=us cn: group1 objectclass: top objectclass: groupofUniqueNames objectclass: orclPrivilegeGroup uniquemember: cn=mary smith,c=us uniquemember: cn=bill smith,c=us uniquemember: cn=john smith,c=us
Group 2	dn: cn=group2,c=us cn: group2 objectclass: top objectclass: groupofUniqueNames objectclass: orclPrivilegeGroup uniquemember: cn=mary jones,c=us uniquemember: cn=joe jones,c=us uniquemember: cn=bill jones,c=us uniquemember: cn=john smith,c=us
Group 3	dn:cn=group3,c=us cn: group3 objectclass: top objectclass: groupofUniqueNames objectclass: orclPrivilegeGroup uniquemember: cn=group2,c=us uniquemember: cn=group1,c=us uniquemember: cn=group4,c=us
Group 4	dn: cn=group4,c=us cn: group4 objectclass: top objectclass: groupofUniqueNames uniquemember: cn=john doe,c=uk uniquemember: cn=jane doe,c=uk uniquemember: cn=anne smith,c=us

Group 3 contains the following nested groups:

- cn=group2, c=us
- cn=group1, c=us
- cn=group4, c=us

Access control policies for Group 3 are applicable to members of Group 3, Group 1, and Group 2 because each of them is marked as a privilege group. These same access control policies are not applicable to the members of Group 4 because Group 4 is not marked as a privilege group.

For example, suppose that the user binds to Oracle Internet Directory as a member of Group 4 with the DN `cn=john doe,c=uk`. None of the access policies applicable to the members of Group 3 apply to this user. This is because his only direct membership is to a non-privilege group. By contrast, if the user were to bind as `cn=john smith,c=us`—that is, as a member of Group 1 and Group 2—then his access rights are governed by access policies set up for members of Group 1, Group 2, and Group 3 (in which Group 1 and Group 2 are nested). This is because all three groups are associated with the object class `orclPrivilegeGroup`.

See Also: Either "[Managing Group Entries by Using Oracle Directory Services Manager](#)" on page 14-8 or "[Managing Group Entries by Using the Command Line](#)" on page 14-13 for instructions on how to modify a group entry to associate it with or disassociate it from either the `orclPrivilegeGroup` or the `orclACPgroup` object class

Access Control Information Components

Access control information represents the permissions that various entities or subjects have to perform operations on a given object in the directory. Thus, an ACI consists of three components:

- The object to which you are granting access
- The entities or subjects to whom you are granting access
- The kind of access you are granting

Object: To What Are You Granting Access?

The *object* part of the access control directive determines the entries and attributes to which the access control applies. It can be either an entry or an attribute.

Entry objects associated with an ACI are implicitly identified by the entry or the subtree where the ACI itself is defined. Any further qualification of objects at the level of attributes is specified explicitly in the ACL expressions.

In the `orclACI` attribute, the entry DN component of the object of the ACI is implicitly that of all entries within the subtree starting with the ACP as its topmost entry. For example, if `dc=com` is an ACP, then the directory area governed by its ACI is:

```
.*, dc=com.
```

However, since the directory area is implicit, the DN component is neither required nor syntactically allowed.

In the `orclEntryLevelACI` attribute, the entry DN component of the object of the ACL is implicitly that of the entry itself. For example, if `dc=example, dc=com` has an entry level ACI associated with it, then the entry governed by its ACI is exactly: `dc=example, dc=com`. Since it is implicit, the DN component is neither required nor syntactically allowed.

The object portion of the ACL allows entries to be optionally qualified by a filter matching some attribute(s) in the entry:

```
filter=(ldapFilter)
```

where *ldapFilter* is a string representation of an LDAP search filter. The special entry selector `*` is used to specify all entries.

Attributes within an entry are included in a policy by including a comma-delimited list of attribute names in the object selector.

```
attr=(attribute_list)
```

Attributes within an entry are excluded from a policy by including a comma-delimited list of attribute names in the object selector.

```
attr!=(attribute_list)
```

The *object* part of an access control directive may also include special keywords. These are:

- `DenyGroupOverride`, which prevents access from being overridden by higher level ACPs
- `AppendToAll`, which causes the subject of an ACI to be added to all other ACIs in that ACP during evaluation.

Note: Access to the entry itself must be granted or denied by using the special object keyword `ENTRY`. Note that giving access to an attribute is not enough; access to the entry itself through the `ENTRY` keyword is necessary.

See Also: [Appendix H, "The Access Control Directive Format"](#) for information about the format or syntax of ACIs

Subject: To Whom Are You Granting Access?

This section describes:

- The entity being granted access
- The bind mode—that is, the authentication mode used to verify the identity of that entity
- The bind IP filter—that is, the IP address filter used to verify the identity of that entity
- The added object constraint, which limits the kind of objects a user can add below the parent when access is granted.

Entity Access is granted to entities, not entries. The entity component identifies the entity or entities being granted access.

You can specify entities either directly or indirectly.

Directly specifying an entity: This method involves entering the actual value of the entity, for example `group=managers`. You can do this by using:

- The wildcard character (`*`), which matches any entry
- The keyword `SELF`, which matches the entry protected by the access
- The keyword `SuperUser`, which matches the `SuperUser` DN specified in the directory.
- A regular expression, which matches an entry's distinguished name, for example, `dn=regex`
- The members of a privilege group object: `group=dn`

Indirectly specifying an entity: This is a dynamic way of specifying entities. It involves specifying a DN-valued attribute that is part of the entry to which you are granting access. There are three types of DN-valued attributes:

- `dnattr`: Use this attribute to contain the DN of the entity to which you are granting or denying access for this entry.
- `groupattr`: Use this attribute to contain the DNs of the administrative groups to which you are granting or denying access for this entry.

- `guidattr`: Use this attribute to contain the global user identifier (orclGUID) of the entry to which you want to grant or deny access for this entry.

For example, suppose you want to specify that Anne Smith's manager can modify the salary attribute in her entry. Instead of specifying the manager DN directly, you specify the DN-valued attribute: `dnattr=manager`. Then, when John Doe seeks to modify Anne's salary attribute, the directory server:

1. Looks up the value for her `manager` attribute and finds it to be John Doe
2. Verifies that the bind DN matches the `manager` attribute
3. Assigns to John Doe the appropriate access

Bind Mode The bind mode specifies the methods of authentication and of encryption to be used by the subject.

There are four authentication modes:

- MD5Digest
- PKCS12
- Proxy
- Simple: Simple password-based authentication

There are three encryption options:

- SASL
- SSL No Authentication
- SSL One Way

Specifying the encryption mode is optional. If it is not specified, then no encryption is used, unless the selected authentication mode is PKCS12. Data transmitted by using PKCS12 is always encrypted.

There is a precedence rule among authentication choices, and it is as follows:

Anonymous < Proxy < Simple < MD5Digest < PKCS12

This rule means that:

- Proxy authentication blocks anonymous access
- Simple authentication blocks both Proxy and Anonymous access
- MD5Digest authentication blocks Simple, Proxy and Anonymous access
- PKCS12 authentication blocks MD5Digest, Simple, Proxy and Anonymous access

The bind mode syntax is:

```
BINDMODE = (LDAP_AUTHENTICATION_CHOICE + [ LDAP_ENCRYPTION_CHOICE ] )
LDAP_AUTHENTICATION_CHOICE = Proxy | Simple | MD5Digest | PKCS12
LDAP_ENCRYPTION_CHOICE = SSLNoAuth | SSLOneway | SASL
```

The `LDAP_ENCRYPTION_CHOICE` is an optional parameter. If you do not specify it, then the directory server assumes that no encryption is to be used.

Bind IP Filter IP address or IP address range of the subject, defined using a standard LDAP filter on the `orclipaddress` attribute. If the subject's IP address matches the filter defined, then the ACI on which it is defined is applicable for that operation.

The bind ip filter syntax is:

```
BINDIFILTER =(LDAPFILTER_FOR_ORCLIPADDRESS)
```

For example:

The filter `(| (orclipaddress=1.2.3.*) (orclipaddress=1.2.4.*))` applies when the subject's IP address begins with 1.2.3 or begins with 1.2.4.

The filter `(& (orclipaddress!=1.2.*) (orclipaddress!=3.4.*))` applies when the subject's IP address does not begin with 1.2 and does not begin with 3.4.

Added Object Constraint When a parent entry has *add* access, it can add objects as entries lower in the hierarchy. The added object constraint can be used to limit that right by specifying an *ldapfilter*.

See Also: [Appendix H, "The Access Control Directive Format"](#) and [Appendix G, "The LDAP Filter Definition"](#)

Operations: What Access Are You Granting?

The kind of access granted can be one of the following:

- None
- Compare/nocompare
- Search/nosearch
- Read/noread
- Selfwrite/noselfwrite
- Write/nowrite
- Add/noadd
- Proxy/noproxy
- Browse/nobrowse
- Delete/nodelete

Note that each access level can be independently granted or denied. The `noxxx` means `xxx` permission is denied.

Note also that some access permissions are associated with entries and others with attributes.

Table 29–2 *Types of Access*

Access Level	Description	Type of Object
Compare	Right to perform compare operation on the attribute value	Attributes
Read	Right to read attribute values. Even if read permission is available for an attribute, it cannot be returned unless there is browse permission on the entry itself.	Attributes
Search	Right to use an attribute in a search filter	Attributes

Table 29–2 (Cont.) Types of Access

Access Level	Description	Type of Object
Selfwrite	Right to add yourself to, delete yourself from, or modify your own entry in a list of DNs group entry attribute. Use this to allow members to maintain themselves on lists. For example, the following command allows people within a group to add or remove only their own DN from the member attribute: access to attr=(member) by dnattr=(member) (selfwrite) The <code>dnattr</code> selector indicates that the access applies to entities listed in the member attribute. The <code>selfwrite</code> access selector indicates that such members can add or delete only their own DN from the attribute.	Attributes
Write	Right to modify/add/delete the attributes of an entry.	Attributes
None	No access rights. The effect of granting no access rights to a subject-object pair is to make the directory appear to the subject as though the object were not present in the directory.	Both entries and attributes
Add	Right to add entries under a target directory entry	Entries
Proxy	Allows the subject to impersonate another user	Entries
Browse	Permission to return the DNs in the search result. It is equivalent to the list permission in X.500. This permission is also required for a client to use an entry DN as the base DN in an <code>ldapsearch</code> operation.	Entries
Delete	Right to delete the target entry	Entries

The entry level access directives are distinguished by the keyword `ENTRY` in the object component.

Note: The default access control policy grants the following to both entries and attributes: Everyone is given access to read, search, write, and compare all attributes in an entry, and `selfwrite` permissions are unspecified. If an entry is unspecified, access is determined at the next highest level in which access is specified.

Access Level Requirements for LDAP Operations

Table 29–3 lists the various LDAP operations and the access required to perform each one.

Table 29–3 LDAP Operations and Access Needed to Perform Each One

Operation	Required Access
Create an object	Add access to the parent entry
Modify	Write access to the attributes that are being modified
ModifyDN	Delete access to the current parent and Add access to the new parent
ModifyDN (RDN)	Write access to the naming attribute—that is, the RDN attribute
Remove an object	Delete access to the object being removed
Compare	Compare access to the attribute and Browse access to the entry
Search	<ul style="list-style-type: none"> ■ Search access on the filter attributes and Browse access on the entry (if only the entry DN must be returned as a result) ■ Search access on the filter attributes, Browse access on the entry, and Read permission on the attributes (for all attributes whose values must be returned as a result)

How ACL Evaluation Works

When a user tries to perform an operation on a given object, the directory server determines whether that user has the appropriate access to perform that operation on that object. If the object is an entry, it evaluates the access systematically for the entry and each of its attributes.

Evaluating access to an object—including an attribute of an entry—can involve examining all the ACI directives for that object. This is because of the hierarchical nature of ACPs and the inheritance of policies from superior ACPs to subordinate ACPs.

The directory server first examines the ACI directives in the entry-level ACI, `orclEntryLevelACI`. It proceeds to the nearest ACP, then considers each superior ACP in succession until the evaluation is complete.

During ACL evaluation, an attribute is said to be in one of the states described in [Table 29-4](#):

Table 29-4 Attribute States During ACL Evaluation

State	Description
Resolved with permission	The required access for the attribute has been granted in the ACI.
Resolved with denial	The required access for the attribute has been explicitly denied in the ACI.
Unresolved	No applicable ACI has yet been encountered for the attribute in question.

In all operations except search, the evaluation stops if:

- Access to the entry itself is denied
- Any of the attributes reach the resolved with denial state

In this case the operation would fail and the directory server would return an error to the client.

In a search operation, the evaluation continues until all the attributes reach the resolved state. Attributes that are resolved with denial are not returned.

This section contains these topics:

- [Precedence Rules Used in ACL Evaluation](#)
- [Use of More Than One ACI for the Same Object](#)
- [Exclusionary Access to Directory Objects](#)
- [ACL Evaluation For Groups](#)

Precedence Rules Used in ACL Evaluation

An LDAP operation requires the BindDN, or subject, of the LDAP session to have certain permissions to perform operations on the objects—including the entry itself and the individual attributes of the entry.

Typically, there could be a hierarchy of access control administration authorities, starting from the root of a naming context down to successive administrative points (or access control policy points). An ACP is any entry which has a defined value for the `orclACI` attribute. Additionally, the access information specific to a single entry can also be represented within the entry itself (`orclEntryLevelACI`).

ACL evaluation involves determining whether a subject has sufficient permissions to perform an LDAP operation. Typically an `orclentryLevelACI` or `orclACI` might not contain all the necessary information for ACL evaluation. Hence, all available ACL information is processed in a certain order until the evaluation is fully resolved.

That order of processing follows these rules:

- The entry level ACI is examined first. ACIs in the `orclACI` are examined starting with the ACP closest to the target entry and then its superior ACP and so on.
- At any point, if all the necessary permissions have been determined, the evaluation stops; otherwise, the evaluation continues.
- Within a single ACI, if the entity associated with the session DN matches more than one item identified in the *by* clause, the effective access evaluates to:
 - The union of all the granted permissions in the matching *by* clause items ANDed with
 - The union of all the denied permissions in the matching *by* clause items

Precedence at the Entry Level ACIs at the entry level are evaluated in the following order:

1. With a filter. For example:

```
access to entry filter=(cn=p*)
by group1 (browse, add, delete)
```

2. Without a filter. For example:

```
access to entry
by group1 (browse, add, delete)
```

Precedence at the Attribute Level At the attribute level, specified ACIs have precedence over unspecified ACIs.

1. ACIs for specified attributes are evaluated in the following order:

- a. Those with a filter. For example:

```
access to attr=(salary) filter=(salary > 10000)
by group1 (read)
```

- b. Those without a filter. For example:

```
access to attr=(salary)
by group1 (search, read)
```

2. ACIs for unspecified attributes are evaluated in the following order:

- a. With a filter. For example:

```
access to attr=(*) filter (cn=p*)
by group1 (read, write)
```

- b. Without a filter. For example:

```
access to attr=(*)
by group1 (read, write)
```

Use of More Than One ACI for the Same Object

Oracle Internet Directory, enables you to define more than one ACI in the ACP of an object. It processes the ACIs associated with that object and stores them as a single ACI in its internal ACP cache. It then applies all the relevant policies in the multiple ACIs specified in the ACP.

The following example of an ACP illustrates how this works.

```
Access to entry by dn="cn=john" (browse,noadd,nodelete)
Access to entry by group="cn=admingroup" (browse,add,nodelete)
Access to entry by dn=".*,c=us" (browse,noadd,nodelete)
```

In this ACP, there are three ACIs for the object entry. When it loads this ACP, Oracle Internet Directory merges these three ACIs as one ACI in its internal ACP cache.

The ACI syntax is:

```
Access to OBJECT> by SUBJECT ACCESSLIST
OBJECT = [ entry | attr [EQ-OR-NEQ] ( * | ATTRLIST ) ]
[ filter = ( LDAPFILTER ) ]
```

This syntax makes possible the following types of objects:

- Entry
- Entry + filter = (LDAPFILTER)
- Attr = (ATTRLIST)
- Attr = (ATTRLIST) + filter = (LDAPFILTER)
- Attr != (ATTRLIST)
- Attr != (ATTRLIST) + filter = (LDAPFILTER)
- Attr = (*)
- Attr = (*) + filter = (LDAPFILTER)

You can define multiple ACIs for any of the above types of objects. During initial loading of the ACP, the directory server merges the ACIs based on which of these object types are defined. The matching criterion is the exact string comparison of the object strings in the ACIs.

If one ACI specifies `ATTR=(ATTRLIST)` and another `ATTR!=(ATTRLIST)`, then `ATTR=(*)` must not be specified as an ACI in the entry. Also, if an ACI specifies `ATTR=(ATTRLIST)`, then, to specify the access rights to attributes not in `ATTRLIST`, `ATTR=(*)` must be used and not `ATTR!=(ATTRLIST)`. `ATTR=(*)` implies all attributes other than those specified in `ATTRLIST`.

Note: When you define multiple ACIs on the same attribute with the same filter, Oracle Internet Directory merges them to create a single ACI in the run-time structure.

When you define multiple ACIs on the same attribute with different filters, Oracle Internet Directory treats them as separate ACIs. In such cases, the precedence order is non-deterministic.

To prevent ambiguous behavior, if you define multiple ACIs with different filters against the same attribute, ensure that the filters yield non-overlapping sets of results.

Exclusionary Access to Directory Objects

If an ACI exists for a given object, you can specify access to all other objects except that one. You do this either by granting access to all the objects, or by denying access to the one object.

In the following example, access is granted to all attributes:

```
access to attr=(*)
by group2 (read)
```

In the following example, access is denied to the userpassword attribute:

```
access to attr!=(userpassword)
by group2 (read)
```

ACL Evaluation For Groups

If an operation on an attribute or the entry itself is explicitly denied at an ACP low in the DIT, then, typically, the ACL evaluation for that object is considered "Resolved with Denial." However, if the user of the session (bindDN) is a member of a group object, then the evaluation continues as if it is still unresolved. If permissions are granted to the user of the session at an ACP higher in the tree through a group subject selector, then such grants have precedence over any denials lower in the DIT.

This scenario is the only case in which an ACL policy at a higher level ACP has precedence over an ACP policy lower in the DIT.

Managing Access Control by Using Oracle Directory Services Manager

You can view and modify access control information within ACPs by using either Oracle Directory Services Manager or command-line tools. This section explains how to accomplish these tasks by using Oracle Directory Services Manager.

Note: Immediately after installing Oracle Internet Directory, be sure to reset the default security configuration as described in "Task 1: Reset the Default Security Configuration" on page 4-1

This section contains these topics:

- [Viewing an ACP by Using Oracle Directory Services Manager](#)
- [Adding an ACP by Using Oracle Directory Services Manager](#)
- [Modifying an ACP by Using Access Control Management in ODSM](#)
- [Adding or Modifying an ACP by Using the Data Browser in ODSM](#)
- [Setting or Modifying Entry-Level Access by Using the Data Browser in ODSM](#)

See Also: "Oracle Identity Management Command-line Tool Reference" in *Oracle Fusion Middleware Reference for Oracle Identity Management* for a description of command-line tools

Viewing an ACP by Using Oracle Directory Services Manager

You can locate and view an ACP as follows:

1. Invoke Oracle Directory Services Manager and connect to the Oracle Internet Directory server as described in "[Invoking Oracle Directory Services Manager](#)" on page 7-9.

2. From the task selection bar, select **Security**.
3. Click **Access Control** in the left pane. All of the defined access control points (ACPs) appear in the left pane, listed by relative DN. Mouse over an entry to see the full DN.
4. Select an ACP to display its information in the right pane.
5. The **Subtree Access Items** section of the page shows the access controls on this ACP for entry level operations, that is, for operations on the entry itself.
 The **Content Access Items** section of the page shows the access controls on this ACP for attribute level operations, that is, for operations on the attributes of the entry.

Adding an ACP by Using Oracle Directory Services Manager

ACPs are entries that contain prescriptive, that is, inheritable, access control information. This information affects the entry itself and all entries below it. You will most likely create ACPs to broadcast large-scale access control throughout a subtree.

Adding an ACP by using Oracle Directory Services Manager involves three tasks:

- [Task 1: Specify the Entry That Will Be the ACP](#)
- [Task 2: Configure Structural Access Items](#)—that is, ACIs that pertain to *entries*
- [Task 3: Configure Content Access Items](#)—that is, ACIs that pertain to *attributes*

See Also: ["Delete a Structural or Content Access Item"](#) on page 29-19

Task 1: Specify the Entry That Will Be the ACP

1. Invoke Oracle Directory Services Manager and connect to the Oracle Internet Directory server as described in ["Invoking Oracle Directory Services Manager"](#) on page 7-9.
2. From the task selection bar, select **Security**.
3. Click **Access Control** in the left pane. All of the defined ACPs appear in the left pane.
4. In the left pane, click the **Create Access Control Policy Point** icon. The New Access Control Point screen appears.
5. Enter the path to the entry you want to create, or click **Browse**, select a DN, and click **OK**.

If the entry is already defined as an ACP, you see an error dialog

6. Alternatively, to create an ACP that is similar to an existing ACP, select the existing ACP in the list under **Access Control Management** in the left pane and click the **Create Like** icon. The New Access Control Point: Create Like screen appears.

Task 2: Configure Structural Access Items

1. To define a new structural access item, that is, an ACI that pertains to an entry, choose the **Create new access item** icon in the **Structural Access Items** section of the New Access Control Point pane or the New Access Control Point: Create Like pane. The Structural Access Item dialog box appears.

Alternatively, you can create a structural access item similar to an existing item. Select an existing structural access item and choose the **Create Copy of Selected Access Item** icon in the **Structural Access Items** section of the New Access

Control Point or New Access Control Point: Create Like pane. The Structural Access Item dialog box appears. Some of the tabs are populated with configuration information, which you can modify as necessary.

The structural Access Item dialog box has four tabs: **Entry Filter**, **Added Object Filter**, **By Whom**, and **Access Rights**. You can use the **Entry Filters** tab page to limit the subtree entries to which an ACI pertains. Use the **Added Object Filter**, **By Whom**, and **Access Rights** tabs to specify the access control.

2. If you want all entries below the ACP to be governed by the ACP, then you do not need to enter anything on the **Entry Filter** tab page; simply proceed to the next step. Otherwise, perform this step.

You might restrict access to an entry based on one or more of that entry's attributes. For example, you might choose to restrict access to all entries in which the title is manager and in which the organization unit is Americas.

To use an existing filter, select **Existing** from the Filter Type menu., then select one of the existing filters.

To create a new filter, select **Create New** from the Filter Type menu, then either type a query string directly into the **LDAP Query** text field, or use the lists and text fields on the search criteria bar to focus your search.

- a. From the list at the left end of the search criteria bar, select an attribute of the entry for which you want to search. Because not all attributes are used in every entry, be sure that the attribute you specify actually corresponds to one in the entry for which you are looking. Otherwise, the search fails.
 - b. From the list in the middle of the search criteria bar, select a filter.
 - c. In the text box at the right end of the search criteria bar, type the value for the attribute you just selected. For example, if the attribute you selected was `cn`, you could type the particular common name you want to find.
 - d. Click **+** to add this search criterion to the **LDAP Query** field.
 - e. To further refine your search, use the list of conjunctions (**AND**, **OR**, **NOT AND**, and **NOT OR**) and the lists and text fields on the search criteria bar to add additional search criteria. Click **+** to add a search criterion to the **LDAP Query** field. Click **X** to delete a search criterion from the **LDAP Query** field.
3. Select the **Added Object Filter** tab page.

You can specify ACIs to restrict the kind of entries a user can add. For example, you can specify an ACI in the DSE root entry that allows users to add only entries with `objectclass=country`. The directory server then verifies that any new entry complies with the constraints in this filter.

To restrict the kind of entries a user can add either type a query string directly into the **LDAP Query** text field, or use the lists and text fields on the search criteria bar to focus your search, following the same steps as in the **Entry Filter** tab page.

4. Select the **By Whom** tab page.
 - a. In the By Whom field, specify the entity or entities to whom you are granting access.
 - b. From the **Authentication Choice** list under Bind Mode, select the type of authentication to be used by the subject (that is, the entity that seeks access).

If you do not choose an authentication method, then any kind of authentication is accepted. The authentication method specified on one node should match the one specified on the node it is communicating with.

From the **Encryption Choice** list under Bind Mode, select the type of encryption to be used.

5. Select the **Access Rights** tab page.

Specify the kinds of rights to be granted:

- **Browse:** Allows the subject to see the entry
- **Add:** Allows the subject to add other entries below this entry
- **Delete:** Allows the subject to delete the entry
- **Proxy:** Allows the subject to impersonate another user

6. Click **OK**. The structural access item you just created appears in the list.

Repeat [Task 2: Configure Structural Access Items](#) to configure additional structural access items in this ACP.

Task 3: Configure Content Access Items

1. To define content access items, that is, ACIs that pertain to attributes, choose the **Create new access item** icon in the **Content Access Items** section of the New Access Control Point pane or the New Access Control Point: Create Like pane. The Content Access Item dialog box appears.

Alternatively, you can create a content access item similar to an existing item. Select an existing content access item and choose the **Create copy of selected access item** icon in the **Content Access Items** section of the New Access Control Point or New Access Control Point: Create Like pane. The Content Access Item dialog box appears. Some of the tabs are populated with configuration information, which you can modify as necessary.

The Content Access Item dialog box has four tabs: **Entry Filter**, **By Whom**, **Attribute**, and **Access Rights**. You can use the **Entry Filters** tab page to limit the subtree entries to which an ACI pertains. Use the **By Whom**, **Attribute**, and **Access Rights** tabs to specify the access control.

2. If you want all entries below the ACP to be governed by the ACP, then you do not need to enter anything on **Entry Filter** tab page; simply proceed to the next step. Otherwise, perform this step.

In an ACP, the access rights apply to the entry and all its subentries unless other filters restrict access further. If appropriate, use the **Entry Filters** tab page to identify the entries to which you are specifying access.

You might restrict access to an entry based on one or more of that entry's attributes. For example, you might choose to restrict access to all entries in which the title is manager and in which the organization unit is Americas.

To use an existing filter, select **Existing** from the Filter Type menu, then select one of the existing filters.

To create a new filter, select **Create New** from the Filter Type menu, then either type a query string directly into the **LDAP Query** text field, or use the lists and text fields on the search criteria bar to focus your search.

- a. From the list at the left end of the search criteria bar, select an attribute of the entry for which you want to search. Because not all attributes are used in every entry, be sure that the attribute you specify actually corresponds to one in the entry for which you are looking. Otherwise, the search fails.
- b. From the list in the middle of the search criteria bar, select a filter.

- c. In the text box at the right end of the search criteria bar, type the value for the attribute you just selected. For example, if the attribute you selected was `cn`, you could type the particular common name you want to find.
 - d. Click **+** to add this search criterion to the **LDAP Query** field.
 - e. To further refine your search, use the list of conjunctions (**AND**, **OR**, **NOT AND**, and **NOT OR**) and the lists and text fields on the search criteria bar to add additional search criteria. Click **+** to add a search criterion to the **LDAP Query** field. Click **X** to delete a search criterion from the **LDAP Query** field.
3. Select the **By Whom** tab page.
 - a. In the By Whom field, specify the entity or entities to whom you are granting access.
 - b. From the **Authentication Choice** list under Bind Mode, select the type of authentication to be used by the subject (that is, the entity that seeks access).

If you do not choose an authentication method, then any kind of authentication is accepted. The authentication method specified on one node should match the one specified on the node it is communicating with.

From the **Encryption Choice** list under Bind Mode, select the type of encryption to be used.
 - c. Specify the entity or entities to whom you are granting access.
 4. Select the **Attribute** tab page.
 - a. From Attribute list, select the attribute to which you want to grant or deny access.
 - b. From the Operator list, select the matching operation to be performed against the attribute. Choices are EQ (Equal (=)) and NEQ (Not Equal (!=)).

For example, if you select EQ and `cn`, then the access rights you grant apply to the `cn` attribute. If you select NEQ and `cn`, then the access rights you grant do not apply to the `cn` attribute.
 5. Select the **Access Rights** tab page.
Specify the kinds of rights to be granted or denied:
 - **Read:** Allows the subject to read the attribute
 - **Search:** Allows the subject to search for the attribute
 - **Write:** Allows the subject to change the attribute
 - **Selfwrite:** Allows the subject specified by the entry itself to change the attribute
 - **Compare:** Allows the subject to compare the value of the attribute with that of other attributes.
 6. Click **OK**. The content access item you just created appears in the list.
Repeat [Task 3: Configure Content Access Items](#) to configure additional content access items in this ACP.

Delete a Structural or Content Access Item

To delete a structural or content access item, select the item and click the **Delete** icon.

Modifying an ACP by Using Access Control Management in ODSM

1. Invoke Oracle Directory Services Manager and connect to the Oracle Internet Directory server as described in ["Invoking Oracle Directory Services Manager"](#) on page 7-9.
2. From the task selection bar, select **Security**.
3. Click **Access Control** in the left pane. All of the defined ACPs appear in the left pane.
4. In the left pane, select an ACP in the list. A tab page for that ACP appears in the right pane.
5. To define a new structural access item, that is, an ACI that pertains to an entry, choose the **Create** icon in the **Structural Access Items** section of the entry tab page. The Structural Access Item dialog box appears.

Alternatively, you can create a structural access item similar to an existing item. Select an existing structural access item and choose the **Create Like** icon in the **Structural Access Items** section of the New Access Control Point or New Access Control Point: Create Like pane. The Structural Access Item dialog box appears. Some of the tabs are populated with configuration information, which you can modify as necessary.

The Structural Access Item dialog box has four tabs: **Entry Filter**, **Added Object Filter**, **By Whom**, and **Access Rights**. You can use the **Entry Filters** tab page to limit the subtree entries to which an ACI pertains. Use the **Added Object Filter**, **By Whom**, and **Access Rights** tabs to specify the access control. Follow the steps beginning with Step 2 under ["Task 2: Configure Structural Access Items"](#) on page 29-16.

6. To modify an existing structural access item, select the item and click **Edit**. The Structural Access Item dialog box appears. Some of the tabs are populated with configuration information, which you can modify as necessary. The tabs are: **Entry Filter**, **Added Object Filter**, **By Whom**, and **Access Rights**. You can use the **Entry Filters** tab page to limit the subtree entries to which an ACI pertains. Use the **Added Object Filter**, **By Whom**, and **Access Rights** tabs to specify the access control. Follow the steps beginning with Step 2 under ["Task 2: Configure Structural Access Items"](#) on page 29-16. When you click **OK**, the changes you made to the structural access item are reflected in the list.
7. To define a new content access item, that is, an ACI that pertains to attributes, choose the **Create** icon in the **Content Access Items** section of the entry tab page. The Content Access Item dialog box appears.

Alternatively, you can create a content access item similar to an existing item. Select an existing content access item and choose the **Create Like** icon in the **Content Access Items** section of the New Access Control Point or New Access Control Point: Create Like pane. The Content Access Item dialog box appears. Some of the tabs are populated with configuration information, which you can modify as necessary.

The Content Access Item dialog box has four tabs: **Entry Filter**, **By Whom**, **Attribute**, and **Access Rights**. You can use the **Entry Filters** tab page to limit the subtree entries to which an ACI pertains. Use the **By Whom**, **Attribute**, and **Access Rights** tabs to specify the access control. Follow the steps beginning with Step 2 under ["Task 3: Configure Content Access Items"](#) on page 29-18.

8. To modify an existing content access item, select the item and click **Edit**. The Content Access Item dialog box appears. It has four tabs: **Entry Filter**, **By Whom**,

Attribute, and **Access Rights**. You can use the **Entry Filters** tab page to limit the subtree entries to which an ACI pertains. Use the **By Whom**, **Attribute**, and **Access Rights** tabs to specify the access control. They are: **Entry Filter**, **Added Object Filter**, **By Whom**, and **Access Rights**. You can use the **Entry Filters** tab page to limit the subtree entries to which an ACI pertains. Use the **Added Object Filter**, **By Whom**, and **Access Rights** tabs to specify the access control. Follow the steps under "[Task 3: Configure Content Access Items](#)" on page 29-18. When you click **OK**, the changes you made appear in the list.

9. To delete a structural or content access item, select the item and click the **Delete** icon.
10. Click **Apply** to effect the changes.

Adding or Modifying an ACP by Using the Data Browser in ODSM

To set subtree-level access by using the Data Browser in Oracle Directory Services Manager:

1. Invoke Oracle Directory Services Manager as described in "[Invoking Oracle Directory Services Manager](#)" on page 7-9.
2. From the task selection bar, choose **Data Browser**.
3. Navigate to the entry you want to set access to.
4. In the navigator pane, select the entry to display its properties in the right pane
5. Select the **Subtree Access** tab page, then create and edit local ACIs in the **Structural Access Item** and **Content Access Item** tabs as described in "[Modifying an ACP by Using Access Control Management in ODSM](#)" on page 20.
6. After you have made the changes, click **Apply**.

Note: You must click **Apply** to send the information you just entered to the directory server. Otherwise, the information is simply held in the Oracle Directory Services Manager cache.

Setting or Modifying Entry-Level Access by Using the Data Browser in ODSM

To set entry-level access by using Oracle Directory Services Manager:

1. Invoke Oracle Directory Services Manager as described in "[Invoking Oracle Directory Services Manager](#)" on page 7-9.
2. From the task selection bar, choose **Data Browser**.
3. Navigate to the entry you want to set access to.
4. In the navigator pane, select the entry to display its properties in the right pane
5. Select the **Local Access** tab page, then create and edit local ACIs in the **Structural Access Item** and **Content Access Item** tabs as described in "[Modifying an ACP by Using Access Control Management in ODSM](#)" on page 20.
6. After you have made the changes, click **Apply**.

Note: You must click **Apply** to send the information you just entered to the directory server.

Managing Access Control by Using Command-Line Tools

As described in ["Introduction to Managing Directory Access Control"](#) on page 29-1, directory access control policy information is represented as user-modifiable configuration attributes. You can manage it by using command-line tools, including `ldapmodify` and `ldapmodifymt`, to set and alter the values of these attributes.

To directly edit the ACI, you should understand the format and semantics of the directory representation of the ACI as described in [Appendix H, "The Access Control Directive Format"](#).

This section contains these topics:

- [Restricting the Kind of Entry a User Can Add](#)
- [Setting Up an Inheritable ACP by Using `ldapmodify`](#)
- [Setting Up Entry-Level ACIs by Using `ldapmodify`](#)
- [Using Wildcards in an LDIF File with `ldapmodify`](#)
- [Selecting Entries by DN](#)
- [Using Attribute and Subject Selectors](#)
- [Granting Read-Only Access](#)
- [Granting Selfwrite Access to Group Entries](#)
- [Defining a Completely Autonomous Policy to Inhibit Overriding Policies](#)

See Also:

- ["LDIF File Formatting Rules and Examples"](#) in *Oracle Fusion Middleware Reference for Oracle Identity Management* for information about how to format input by using LDIF, the required input format for line mode commands
- The `ldapmodify` command-line tool reference in *Oracle Fusion Middleware Reference for Oracle Identity Management* for information about how to run `ldapmodify`
- [Appendix H, "The Access Control Directive Format"](#) for information about the format or syntax of ACI

Restricting the Kind of Entry a User Can Add

You can specify ACIs to restrict the kind of entries a user can add. For example, you can specify an ACI in the DSE root entry that allows users to add only entries with `objectclass=country`. To do this, you use the `added_object_constraint` filter. The directory server then verifies that any new entry complies with the constraints in this filter.

The following example specifies that:

- The subject `cn=admin,c=us` can browse, add, and delete under `organization` entries.
- The subject `cn=admin,c=us` can add `organizationalUnit` objects under `organization` entries
- All others can browse under `organization` entries

```
access to entry filter=(objectclass=organization)
by group="cn=admin,c=us"
constraintonaddedobject=(objectclass=organisationalunit)
```



```
(browse,add,delete)
by * (browse)
```

Setting Up an Inheritable ACP by Using Ildapmodify

This example sets up subtree access permissions in an `orclACI` at the root DSE by using an LDIF file named `my_ldif_file`. Because this example refers to the `orclACI` attribute, this access directive governs all the entries in the DIT.

```
ldapmodify -v -h myhost -D "cn=Directory Manager, o=IMC, c=US" -q -f my_ldif_file
```

The LDIF file, `my_ldif_file`, contains the following:

```
dn:
changetype: modify
replace: orclaci
orclaci: access to entry
  by dn="cn=directory manager, o=IMC, c=us" (browse, add, delete)
  by * (browse, noadd, nodelete)
orclaci: access to attr=(*)
  by dn="cn=directory manager, o=IMC, c=us" (search, read, write, compare)
  by self (search, read, write, compare)
  by * (search, read, nowrite, nocompare)
```

Setting Up Entry-Level ACIs by Using Ildapmodify

This example sets up entry-level access permissions in the `orclEntryLevelACI` attribute by using an LDIF file named `my_ldif_file`. Because this example refers to the `orclentrylevelACI` attribute, this access directive governs only the entry in which it resides.

```
ldapmodify -v -h myhost -D "cn=Directory Manager, o=IMC, c=US" -q -f my_ldif_file
```

The LDIF file, `my_ldif_file`, contains the following:

```
dn:
changetype: modify
replace: orclentrylevelaci
orclentrylevelaci: access to entry
  by dn="cn=directory manager, o=IMC, c=us" (browse, add, delete)
  by * (browse, noadd, nodelete)
orclentrylevelaci: access to attr=(*)
  by dn="cn=directory manager, o=IMC, c=us" (search, read, write, compare)
  by * (search, read, nowrite, nocompare)
```

Note: In this example, no DN value is specified. This means that this ACI pertains to the root DSE and its attributes only.

Using Wildcards in an LDIF File with Ildapmodify

This example shows the use of wildcards (*) in the object and subject specifiers. For all entries within the `example.com` domain, it grants to everyone browse permission on all entries, and read and search permissions on all attributes.

```
ldapmodify -v -h myhost -D "cn=Directory Manager, o=IMC, c=US" -q -f my_ldif_file
```

In the ACP at `dc=com`, the `orclACI` attribute is specified as follows:

```
access to entry by * (browse)
access to attr=(*) by * (search, read)
```

Note that, in order to enable reading the attributes, you must grant permission to browse the entries.

Selecting Entries by DN

This example shows the use of a regular expression to select the entries by DN in two access directives. It grants to everyone read-only access to the address book attributes under `dc=example,dc=com` access.

```
ldapmodify -v -h myhost -D "cn=Directory Manager, o=IMC, c=US" -q -f my_ldif_file
```

The `orclACI` attribute of `dc=example,dc=com` is specified as follows:

```
access to entry by * (browse)
access to attr=(cn, telephone, email) by * (search, read)
```

The `orclACI` attribute of `dc=us, dc=example,dc=com` is specified as follows:

```
access to entry by * (browse)
access to attr=(*) by dn=".*,dc=us,dc=example,dc=com" (search, read)
```

Using Attribute and Subject Selectors

This example shows the use of an attribute selector to grant access to a specific attribute, and various subject selectors. The example applies to entries in the `dc=us,dc=example,dc=com` subtree. The policy enforced by this ACI can be described as follows:

- For all entries within the subtree, the administrator has add, delete, and browse permissions. Others within the `dc=us` subtree can browse, but those outside it have no access to the subtree.
- The `salary` attribute can be modified by your manager and viewed by yourself. No one else has access to the `salary` attribute.
- The `userPassword` attribute can be viewed and modified by yourself and the administrator. Others can only compare this attribute.
- The `homePhone` attribute can be read and written by yourself and viewed by anyone else.
- For all other attributes, only the administrator can modify values. Everyone else can compare, search, read, but cannot update attribute values.

```
ldapmodify -v -h myhost -D "cn=Directory Manager, o=IMC, c=US" -q -f my_ldif_file
```

The `orclACI` attribute of `dc=us,dc=example,dc=com` is specified as follows:

```
access to entry
by dn="cn=admin, dc=us,dc=example,dc=com" (browse, add, delete)
by dn=".*, dc=us,dc=example,dc=com" (browse)
by * (none)
```

```
access to attr=(salary)
by dnattr=(manager) (read, write)
by self (read)
by * (none)
```

```
access to attr=(userPassword)
by self (search, read, write)
```

```

by dn="cn=admin, dc=us,dc=example,dc=com" (search, read, write)
by * (compare)

access to attr=(homePhone)
by self (search, read, write)
by * (read)

access to attr != (salary, userPassword, homePhone)
by dn="cn=admin, dc=us,dc=example,dc=com" (compare, search, read, write)
by * (compare, search, read)

```

Granting Read-Only Access

This example gives to everyone read-only access to address book attributes under `dc=example, dc=com`. It also extends to everyone read access to all attributes within the `dc=us, dc=example, dc=com` subtree only.

```
ldapmodify -v -h myhost -D "cn=Directory Manager, o=IMC, c=US" -q -f my_ldif_file
```

The `orclACI` attribute of `dc=example, dc=com` is specified as follows:

```

access to entry by * (browse)
access to attr=(cn, telephone, email) by * (search, read)

```

The `orclACI` attribute of `dc=us, dc=example, dc=com` is specified as follows:

```

access to entry by * (browse)
access to attr=(*) by dn=".*,dc=us,dc=example,dc=com" (search, read)

```

Granting Selfwrite Access to Group Entries

This example enables people within the US domain to add or remove only their own name (DN) to or from the `member` attribute of a particular group entry—for example, a mailing list.

```
ldapmodify -v -h myhost -D "cn=Directory Manager, o=IMC, c=US" -q -f my_ldif_file
```

The `orclEntryLevelACI` attribute of the group entry is specified as follows:

```

access to attr=(member)
by dn=".*, dc=us,dc=example,dc=com" (selfwrite)

```

Defining a Completely Autonomous Policy to Inhibit Overriding Policies

This example denies group override.

```
ldapmodify -v -h myhost -D "cn=Directory Manager, o=IMC, c=US" -q -f my_ldif_file
```

The example uses the following DNs:

Table 29–5 *DNs Used in Example*

Container	DN
Naming context to be restricted from Group overriding policies	<code>c=us</code>
User container	<code>cn=users, c=us</code>
Sensitive data	<code>cn=appdata</code>

Table 29–5 (Cont.) DNs Used in Example

Container	DN
User admin group for this naming context	cn= user admin group, cn=users,c=us
Security admin group or this naming context	cn= security admin group, cn=users,c=us
Global password admin group for all naming contexts that reset passwords	cn=password admin group

The policy requirements for c=us are as follows:

- Users can browse and read their information.
- The user security admin can modify the information under c=us except for passwords and ACPs.
- The security admin group can modify policies under c=us.
- The global password admin and the user can reset a password.
- All other users have no permissions.
- This policy cannot be overridden.

Required ACP:

```
Access to entry DenyGroupOverride
by dn=".*,c=us" (browse,noadd,nodelete)
by group="cn=User admin group,cn=users,c=us" (browse,add,delete)
```

```
Access to attr=(orclaci) DenyGroupOverride
by group="cn=security admin group,cn=users,c=us" (search,read,write,compare)
by * (none)
```

```
Access to attr=(userpassword) DenyGroupOverride
by self (search,read,write,compare)
by group="cn=password admin group" (search,read,write,compare)
by * (none)
```

```
Access to attr=(*) DenyGroupOverride
by self (search,read,nowrite,compare)
by group="cn= User admin group,cn=users,c=us" (search,read,write,compare)
by * (none)
```

Managing Password Verifiers

Password verifiers are the security credentials used to authenticate users to Oracle Internet Directory and other Oracle components. This chapter explains how Oracle Internet Directory centrally stores these password verifiers.

This chapter contains these topics:

- [Introduction to Password Verifiers for Authenticating to the Directory](#)
- [Managing Hashing Schemes for Password Verifiers for Authenticating to the Directory](#)
- [Introduction to Password Verifiers for Authenticating to Components](#)
- [Managing Password Verifier Profiles for Oracle Components by Using ODSM](#)
- [Managing Password Verifier Profiles for Components by Using Command-Line Tools](#)
- [Introduction to Generating Verifiers by Using Dynamic Parameters](#)
- [Configuring Oracle Internet Directory to Generate Dynamic Password Verifiers](#)

Introduction to Password Verifiers for Authenticating to the Directory

When a user leaves a company or changes jobs, that user's privileges should change the same day to guard against misuse of old or unused accounts and privileges. Without centralized password administration, an administrator in a large enterprise with user accounts and passwords distributed over many databases may not be able to make the changes as quickly as good security requires.

Oracle Internet Directory centrally stores security credentials to make their administration easy for both end users and administrators. It stores:

- Passwords for authenticating users to the directory itself
- Password verifiers for authenticating users to other Oracle components

Users can store non-Oracle authentication credentials if the non-Oracle applications are directory enabled. These applications must create their own container under the Products entry.

Oracle Internet Directory stores a user's directory password in the `userPassword` attribute. You can protect this password by storing it as a Base64 encoded string of a one-way hashed value by using one of Oracle Internet Directory's supported hashing algorithms. Storing passwords as one-way hashed values—rather than as encrypted values—more fully secures them because a malicious user can neither read nor decrypt them.

The default userPassword hashing algorithm for Oracle Internet Directory has been changed from MD4 to SHA. This default scheme is in effect for new installations only. All userPassword attributes created after a new install are one-way hashed using SHA, then stored in Oracle Internet Directory.

When you perform an upgrade, the default hashing scheme in effect before upgrade is retained. For example, if the default scheme before the upgrade was MD4, then MD4 remains the default scheme after the upgrade. To ensure greater security of userPasswords, change the default scheme to SHA immediately after the upgrade. When you change the default scheme to SHA, user login is unaffected. For greater security, require users to reset their passwords so that SHA values hash values are stored in Oracle Internet Directory.

Note: For even greater security, three variants of the more secure SHA-2 algorithm, as well as salted versions of those variants, are available, as of 11g Release 1 (11.1.1.4.0).

Oracle Internet Directory stores the user password in a reversible encrypted format in a configuration attribute called `orclrevpwd`. This attribute is generated only if the attribute `orclpwdencryptionenable` in the password policy entry is set to 1. The `orclrevpwd` attribute is maintained securely within the server and cannot be queried.

This section contains these topics:

- [Userpassword Verifiers and Authentication to the Directory](#)
- [Hashing Schemes for Creating Userpassword Verifiers](#)
- [Managing Hashing Schemes for Password Verifiers for Authenticating to the Directory](#)

Userpassword Verifiers and Authentication to the Directory

Oracle Internet Directory can protect a user's directory password by storing it in the userPassword attribute as a one-way hashed value. You select the hashing algorithm you want to use. Storing passwords as one-way hashed values—rather than as encrypted values—more fully secures them because a malicious user can neither read nor decrypt them.

During authentication to a directory server, clients supply a password to the directory server in clear text. The directory server hashes this password by using the hashing algorithm specified in the DSE attribute `orclcryptoscheme`. It then verifies it against the hashed password stored in the binding entry's userPassword attribute. If the hashed password values match, then the server authenticates the user. If they do not match, then the server sends the user an "Invalid Credentials" error message.

For external users, Oracle Internet Directory generates the attribute `orclrevpwd` during authentication. In particular this attribute is generated when clients authenticate using `ldapcompare` on the user's cleartext password. If the attribute `orclrevpwd` does not exist, then the Oracle Internet Directory server generates this attribute using the cleartext password provided for authentication. However this attribute is not generated if external users are authenticated against Oracle Internet Directory using `ldapbind`.

Hashing Schemes for Creating Userpassword Verifiers

During installation, Oracle Identity Management 11g Installer sets the one-way hashing scheme for protecting user passwords to the directory to SHA. This value is

stored in the `orclCryptoScheme` attribute in the root DSE. You can change that value to any of the following hashing schemes:

- MD4: A one-way hash function that produces a 128-bit hash, or message digest
- MD5: An improved and more complex version of MD4
- SHA-1: Secure Hash Algorithm, which produces a 160-bit hash, longer than MD5. The algorithm is slightly slower than MD5, but the larger message digest makes it more secure against brute-force collision and inversion attacks. Potential vulnerabilities have been found in SHA-1
- SSHA: Salted Secure Hash Algorithm. This is similar to SHA, but is generated by using a random salt with the password.
- SHA256, SHA384, SHA512: Variants of the more secure SHA-2 algorithm. The numbers refer to the digest sizes of the hash functions.
- SSHA256, SSHA384, SSHA512: Salted versions of the three SHA-2 algorithms.
- SMD5: Salted MD5. This is similar to MD5, but is generated by using a random salt with the password.
- UNIX Crypt: The UNIX hashing algorithm
- None: Passwords are stored in clear text.

See ["Managing Hashing Schemes for Password Verifiers for Authenticating to the Directory"](#) on page 30-3 and ["Managing System Configuration Attributes by Using ODSM Data Browser"](#) on page 9-18.

Note: In the past Oracle Internet Directory supported the DES variant of UNIX Crypt. In 11g Release 1 (11.1.1) Oracle Internet Directory has the capability to understand the MD5 and Blowfish variants of UNIX Crypt. This means pre-hashed passwords using these other variants can be imported into Oracle Internet Directory as-is and will continue to work. However, selecting UNIX Crypt as `orclcryptoscheme` will continue to only generate the DES variant of UNIX Crypt.

Managing Hashing Schemes for Password Verifiers for Authenticating to the Directory

The following example changes the password hashing algorithm to SHA512 by using an LDIF file named `my_ldif_file`:

```
ldapmodify -D cn=orcladmin -q -h myhost -p 3060 -v -f my_ldif_file
```

The LDIF file, `my_ldif_file`, contains:

```
dn:
changetype: modify
replace: orclcryptoscheme
orclcryptoscheme: SHA512
```

Introduction to Password Verifiers for Authenticating to Components

Oracle components store both passwords and password verifiers in Oracle Internet Directory. This section contains these topics:

- [About Password Verifiers for Authenticating to Oracle Components](#)
- [Attributes for Storing Password Verifiers for Authenticating to Oracle Components](#)
- [Default Verifiers for Oracle Components](#)
- [How Password Verification Works for an Oracle Component](#)
- [Managing Password Verifier Profiles for Oracle Components by Using ODSM](#)
- [Managing Password Verifier Profiles for Components by Using Command-Line Tools](#)

About Password Verifiers for Authenticating to Oracle Components

Oracle components can store their password values in Oracle Internet Directory as password verifiers. A password verifier is a hashed version of a clear text password, which is then encoded as a BASE64 encoded string.

You can choose one of these hashing algorithms to derive a password verifier:

- MD5: An improved, and more complex, version of MD4
- SHA-1: Secure Hash Algorithm, which produces a 160-bit hash, longer than MD5. The algorithm is slightly slower than MD5, but the larger message digest makes it more secure against brute-force collision and inversion attacks.
- SSHA and SMD5
- SHA256, SHA384, SHA512: Variants of the more secure SHA-2 algorithm. The numbers refer to the digest sizes of the hash functions.
- SSHA256, SSHA384, SSHA512: Salted versions of the three SHA-2 algorithms.
- UNIX Crypt: The UNIX hashing algorithm
- SASL/MD5: Simple Authentication and Security Layer/MD5, which adds authentication support to connection-based protocols and uses a challenge-response protocol.
- O3LOGON: A proprietary Oracle algorithm for generating verifiers. It is similar to SASL/MD5 in that it uses a challenge-response protocol.
- ORCLWEBDAV: A proprietary algorithm identical to SASL/MD5 which takes the user name in the format `username@realm`.
- ORCLLM: Oracle's representation of the SMBLM algorithm. The SMBLM algorithm is Oracle's representation of the LM variant of the SMB/CIFS challenge/response authentication algorithm.
- ORCLNT: Oracle's representation of the SMBNT algorithm. The SMBNT algorithm is Oracle's representation of the NT variant of the SMB/CIFS challenge/response authentication algorithm.

During Oracle application installation, the Oracle Identity Management 11g Installer creates for that application a password verifier profile entry containing all the necessary password verification information. It places this entry, as shown in [Figure 30-1](#), immediately below the application entry, which resides under the products entry, which, in turn, resides under the realm-specific Oracle Context.

This verifier profile entry is applicable to users in the specified realm only. For verifier generation to take effect, you must set the `orclcommonusersearchbase` attribute in the common entry of the realm-specific Oracle context to the appropriate value.

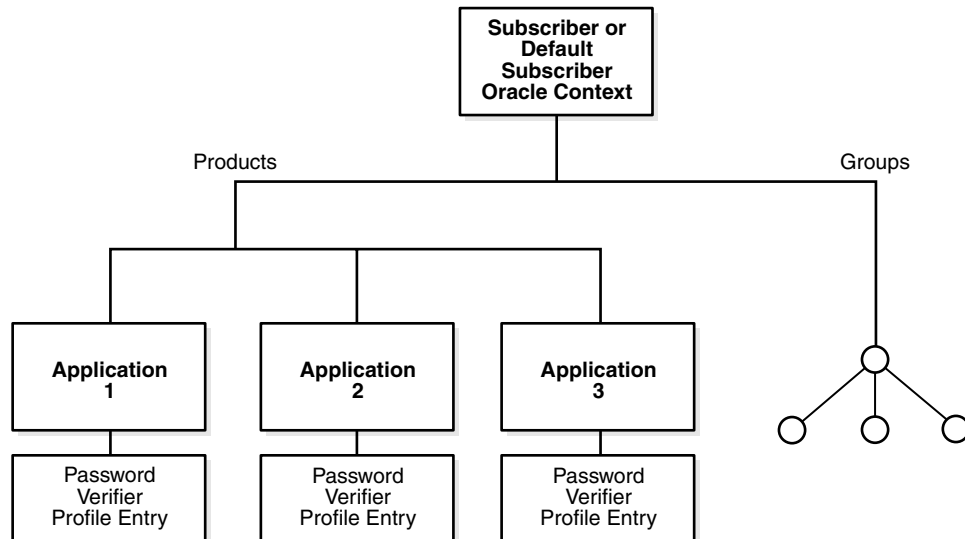
Figure 30–1 Location of the Password Verifier Profile Entry

Attributes for Storing Password Verifiers for Authenticating to Oracle Components

Both the directory and Oracle components store the user password in the user entry, but in different attributes. Whereas the directory stores user passwords in the `userPassword` attribute, Oracle components store user password verifiers in the `authPassword`, `orclPasswordVerifier`, or `orclpassword` attribute. [Table 30–1](#) describes each of the attributes used by Oracle components.

Table 30–1 Attributes for Storing Password Verifiers in User Entries

Attribute	Description
<code>authPassword</code>	<p>Attribute for storing a password to an Oracle component when that password is the same as that used to authenticate the user to the directory, namely, <code>userpassword</code>. The value in this attribute is synchronized with that in the <code>userpassword</code> attribute.</p> <p>Several different applications can require the user to enter the same clear text password used for the directory, but each application may hash it with a different algorithm. In this case, the same clear text password can become the source of several different password verifiers.</p> <p>This attribute is multivalued and can contain all the other verifiers that different applications use for this user's clear text password. If the <code>userpassword</code> attribute is modified, then the <code>authpasswords</code> for all applications are regenerated.</p>
<code>orclPasswordVerifier</code>	<p>Attribute for storing a password to an Oracle component when that password is different from that used to authenticate the user to the directory, namely, <code>userpassword</code>. The value in this attribute is not synchronized with that in the <code>userpassword</code> attribute.</p> <p>Like <code>authPassword</code>, this attribute is multivalued and can contain all the other verifiers that different applications use for this user's clear text password.</p>

Table 30–1 (Cont.) Attributes for Storing Password Verifiers in User Entries

Attribute	Description
orclPassword	<p>Attribute for storing only the 03LOGON verifier for enterprise users. The 03LOGON verifier is synchronized with the userpassword attribute, and it is generated by default for all user entries associated with the orcluserv2 object class.</p> <p>When Oracle Internet Directory is installed, a database security profile entry is created by default in the Root Oracle Context. The presence of this entry triggers the generation of 03LOGON verifiers for user entries associated with the orcluserv2 object class.</p>

Each of these attribute types has appID as an attribute subtype. This attribute subtype uniquely identifies a particular application. For example, the appID can be the ORCLGUID of the application entry. This attribute subtype is generated during application installation.

In [Figure 30–2](#) on page 30-7, various Oracle components store their password verifiers in Oracle Internet Directory. Oracle Single Sign-On uses the same password as that for the directory, and hence stores it in the authPassword attribute. The other applications use different passwords and hence store their verifiers in orclPasswordVerifier attribute.

The following is an example of an application-specific verifier profile entry. Any application that chooses not to use the common verifier framework must create its own verifier profile entry, similar to the one given in the following example. The orclappid is set to the GUID of the application container and it will also be used as a subtype in the verifier attributes authpassword and orclpasswordverifier.

```
dn: cn=IFSVerifierProfileEntry,cn=IFS,cn=Products,cn=OracleContext,o=Oracle,dc=com
objectclass:top
objectclass:orclpwdverifierprofile
cn:IFSVerifierProfileEntry
orclappid:8FF2DFD8203519C0E034080020C34C50
orclpwdverifierparams;authpassword: crypto:SASL/MDS $ realm:dc=com
orclpwdverifierparams;orclpasswordverifier: crypto:ORCLLM
orclpwdverifierparams;authpassword: crypto:ORCLWEBDAV $ realm:dc=com
$ usernameattribute: mail $ usernamecase: lower $ nodomain: TRUE
```

SASL/MD5 and ORCLWEBDAV verifiers are generated by using user name, realm, and password. The user name attribute to be used can be specified in the verifier profile entry. The case of the user name can also be specified as either upper or lower. The ORLWEBDAV verifier is generated by appending the name of the identity management realm to the user name. If this is not required, then the verifier profile entry must specify nodomain: TRUE.

In the previous example, ORCLWEBDAV verifier is generated by using the value of the mail attribute without appending the name of the realm. Also, the user name is converted to lowercase before generating the verifier.

Figure 30–2 Authentication Model

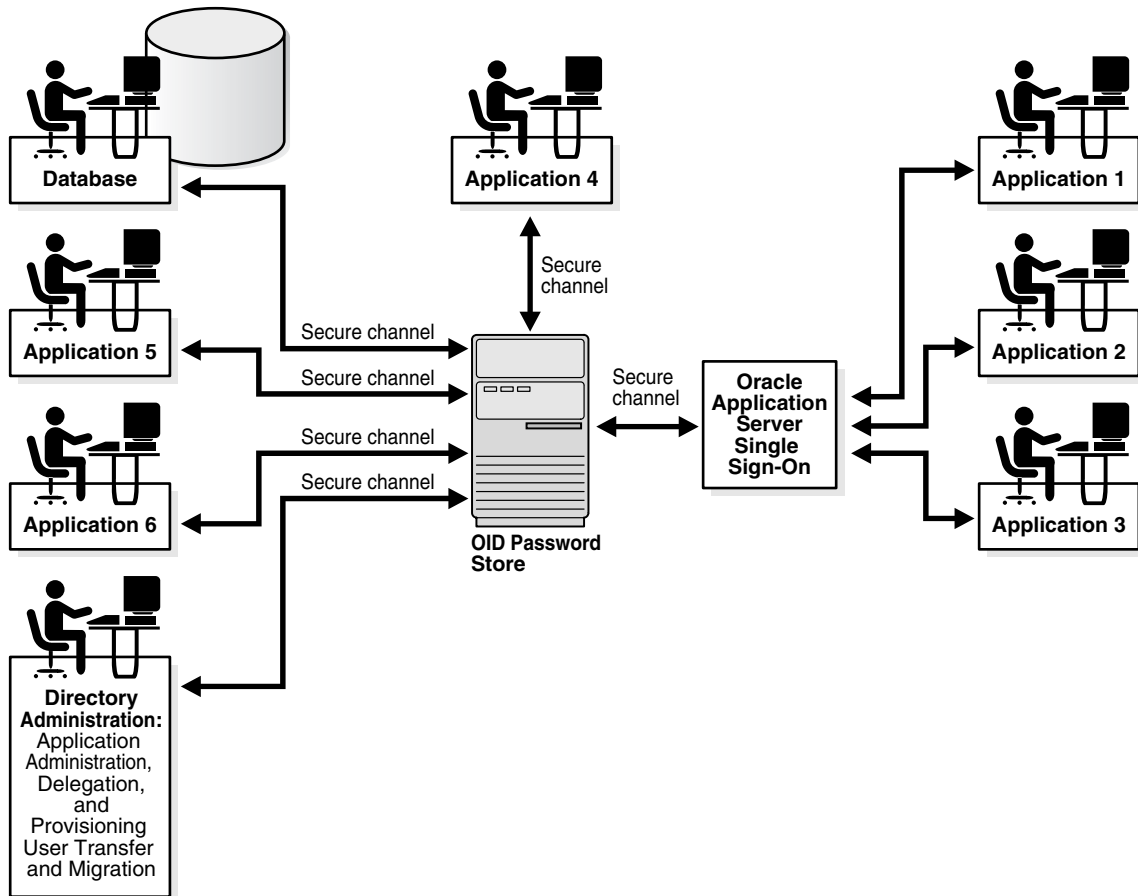

This illustration shows the authentication model used in password storage. At the center is an OID Password Store. To the right are applications 1, 2, and 3, each of which authenticates to the directory by way of Oracle9iAS Single Sign-On. The latter connects to the directory by way of a secure channel. On the other side of the OID Password Store, a database, three applications, and the directory administrator authenticate directly to the OID Password Store.

Default Verifiers for Oracle Components

To save you from having to create a profile for each Oracle component, and to enable sharing of password verifiers across all components, Oracle Internet Directory provides a default set of password verifiers. The default verifier types are MD5, MD5-IFS (SASL/MD5 with the user name set to the value of the nickname attribute and realm = Authorized_Users), WEBDAV, ORCLLM, and ORCLNT.

Two profile entries are required: one for applications using personal identification numbers (PINs), which use numeric values only, and another for applications using alphanumeric passwords.

The verifiers for PIN-based applications—for example, the voice mail application in OracleAS Unified Messaging—are stored in the `orclpasswordverifier;orclcommonpin` attribute. The subtype `orclcommonpin` is used to distinguish numeric PINs from alphanumeric passwords.

Any application that uses numeric PINs can directly query or compare against the attribute `orclpasswordverifier;orclcommonpin`.

The verifiers for alphanumeric password-based applications can be stored in either:

- The `authpassword;orclcommonpwd` attribute—If an application requires its verifier to be synchronized with the `userpassword` attribute
- The `orclpasswordverifier;orclcommonpwd` attribute—If synchronization with the `userpassword` attribute is not required

The subtype `orclcommonpwd` is used to distinguish alphanumeric passwords from numeric PINs. The verifier attributes subtyped by `orclcommonpwd` can be queried against.

These profile entries also contain the list of subscribed applications and these are specified as values in the `uniquemember` attribute in the profile entries. By default, the DN of the Oracle Single Sign-On identity is one of the subscribed applications. This means that Oracle Single Sign-On is a proxy member for all its partner applications. All applications not based on Oracle Single Sign-On must add their identities (DNs) to the `uniquemember` attribute in the appropriate profile entry.

The following is an example of the profile entries.

```
Cn=defaultSharedPwdProfileEntry, cn=common, cn=products, cn=oraclecontext
Objectclass: orclpwdverifierprofile
Objectclass: orclcommonpwdprofile
Cn: defaultSharedPwdProfileEntry
Orclappid: orclcommonpwd
Orclpwdverifierparams;authpassword: crypto:SASL/MD5 $ realm:Authorized_Users
Orclpwdverifierparams;authpassword: crypto:ORCLWEBDAV $ realm:Authorized_Users
Orclpwdverifierparams;authpassword: crypto:ORCLLM
Orclpwdverifierparams;authpassword: crypto:ORCLNT
Orclpwdverifierparams;orclpasswordverifier: crypto:SSHA
Uniquemember: cn=SSO,cn=Products,cn=OracleContext
Uniquemember: cn=IFS,cn=Products,cn=OracleContext
```

```
Cn=defaultSharedPINProfileEntry, cn=common, cn=products, cn=oraclecontext
Objectclass: orclpwdverifierprofile
Objectclass: orclcommonpwdprofile
Cn: defaultSharedPinProfileEntry
Orclappid: orclcommonpin
Orclpwdverifierparams;orclpasswordverifier: crypto:MD5
Orclpwdverifierparams;orclpasswordverifier: crypto:SSHA
Uniquemember: cn=SSO,cn=Products,cn=OracleContext
Uniquemember: cn=Unified Messaging,cn=Products,cn=OracleContext
```

For PIN-based applications, `authpassword` is not an option. Such applications use the `orclpasswordverifier` attribute.

How Password Verification Works for an Oracle Component

Figure 30–3 shows an example of password verification for an Oracle component. In this example, the Oracle component stores its password verifiers in the directory.

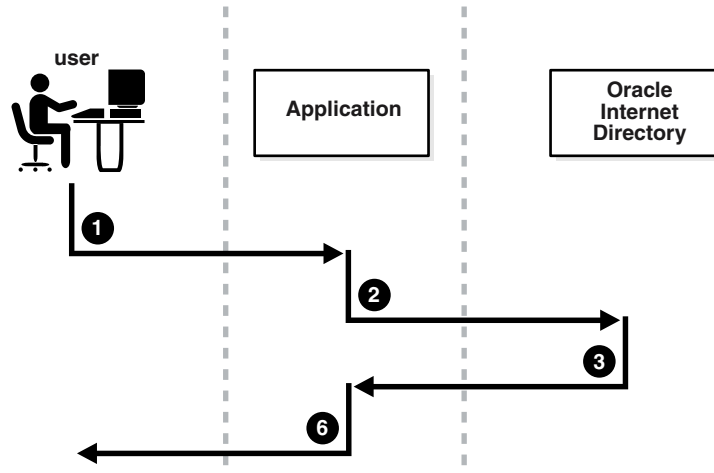
Figure 30–3 How Password Verification Works

1. The user tries to log in to an application by entering a user name and a clear text password.
2. The application sends the clear text password to the directory server. If the application stores password verifiers in the directory, then the application requests the directory server to compare this password value with the corresponding one in the directory.
3. The directory server:
 - a. Generates a password verifier by using the hashing algorithm specified for the particular application
 - b. Compares this password verifier with the corresponding password verifiers in the directory. For the compare operation to be successful, the application must provide its `appID` as the subtype of the verifier attribute. For example:

```
ldapcompare -p 3060 -D "DN_of_the_application_entity" -q \
              -b "DN_of_the_user" -a orclpasswordverifier; appID \
              -v password_of_the_user
```
 - c. Notifies the application of the results of the compare operation.
4. Depending on the message from the directory server, the application either authenticates the user or not.

If an application does not use the compare operation, then it:

1. Hashes the clear text password entered by the user
2. Retrieves from the directory the hashed value of the clear text password as entered by the user
3. Initiates a challenge to the user to which the client responds. If the response is correct, then the application authenticates the user.

Managing Password Verifier Profiles for Oracle Components by Using ODSM

You can use Oracle Directory Services Manager to view and modify password verifier profile entries, including password hashing schemes.

To view and modify an application's password verifiers:

1. Invoke Oracle Directory Services Manager and connect to the Oracle Internet Directory server as described in "[Invoking Oracle Directory Services Manager](#)" on page 7-9.
2. From the task selection bar, select **Security**.
3. Expand **Password Verifier** in the left pane. All of the password verifiers appear in the left pane.
4. Select the password verifier you want to view. The right pane displays the Password Verifier Profile tab page.
5. You can modify the hashing algorithm used to generate a password verifier. In the Password Verifier Profile dialog box, specify the hashing algorithm in the **Oracle Password Parameters** field. The syntax is:

```
crypto:hashing_algorithm
```

For example, if you are using the ORCLLM hashing algorithm, then you would enter:

```
crypto:ORCLLM
```

If you are using SASL/MD5, for example, you can enter the following:

```
crypto:SASL/MD5 $ realm:dc=com
```

Managing Password Verifier Profiles for Components by Using Command-Line Tools

You can view and modify password verifier profiles by using command-line tools.

Viewing a Password Verifier Profile by Using Command-Line Tools

To view an application's password verifier, perform a search specifying the DN of the password verifier profile.

Example: Modifying a Password Verifier Profile by Using Command-Line Tools

This example changes the hashing algorithm in an application password verifier profile entry. This password verifier synchronizes with the user's directory password.
Type:

```
ldapmodify -D "cn=orcladmin" -q -p 3060 -h my_host -v -f file.ldif
```

where `file.ldif` contains:

```
dn: cn=MyAppVerifierProfileEntry,cn=MyApp,cn=Products,cn=OracleContext,
  o=my_company,dc=com
changetype: modify
replace: orclPwdVerifierParams
orclPwdVerifierParams;authPassword: crypto:SASL/MD5 $ realm:dc=com
```

Introduction to Generating Verifiers by Using Dynamic Parameters

The password verifiers described previously are static password verifiers. That is, they are generated with preconfigured parameters, typically during application installation. Some applications, including Oracle Calendar, Oracle Email, and Oracle Wireless and Voice, require Oracle Internet Directory to generate dynamic password verifiers.

Oracle Internet Directory generates a dynamic password verifier when an application requests one. Dynamic verifiers are based on application parameters that are not available until run time.

In order to generate a dynamic password verifier, Oracle Internet Directory needs a user password that was previously stored in a reversible encrypted format. Oracle Internet Directory stores such values in the configuration attributes `orclrevpwd` and `orclunsyncrevpwd`. Encrypted values based on `userpassword` are stored in the parameter `orclrevpwd`. Encrypted values based on passwords other than `userpassword`, such as the numeric PINs used by Oracle Calendar, are stored in the parameter `orclunsyncrevpwd`.

Configuring Oracle Internet Directory to Generate Dynamic Password Verifiers

If you are deploying applications that use `userpassword` and that need dynamic password verifiers, you must ensure that Oracle Internet Directory generates the `orclrevpwd` parameter. Oracle Internet Directory generates the attribute `orclrevpwd` when you provision a user if the attribute `orclpwdencryptionenable` in the realm password policy entry is set to 1. Therefore, you must set `orclpwdencryptionenable` to 1 before you provision users.

To check the value of `orclpwdencryptionenable`, you can use `ldapsearch` to query the `pwdpolicy` entry effective on the entry being examined. For example, to query the default `pwdpolicy`, you would type:

```
$ ldapsearch -p port -q -D "cn=orcladmin" \
  -b "cn=default,cn=pwdPolicies,cn=Common,cn=Products,cn=OracleContext" \
  -s base "objectclass=*
```

If `orclpwdencryptionenable` is not listed or is equal to 0, set it to 1 by using `ldapmodify` with an LDIF file similar to this:

```
dn: cn=DefaultSharedPinProfileEntry,cn=Common,cn=Products,cn=Oraclecontext
cn: DefaultSharedPinProfileEntry
orclappid: orclpwdencryptionenable
orclpwdencryptionenable: 1
```

Alternatively, if users were provisioned before you set `orclpwdencryptionenable`, all users must reset their user passwords to trigger the generation of the encrypted value.

If you are deploying applications that use a numeric PIN and that need dynamic password verifiers, you must ensure that Oracle Internet Directory can use the crypto type 3DES in order to generate the value stored in `orclunsyncrevpwd`. You must specify 3DES as a value of the attribute `orclpwdverifierparams;orclpasswordverifier` in the common verifier profile entry under the root oracle context. The default DN of this entry is `cn=DefaultSharedPINProfileEntry,cn=Common,cn=Products,cn=OracleContext`. To set the value, you would use the following LDIF file:

```
dn: cn=DefaultSharedPinProfileEntry,cn=Common,cn=Products,cn=Oraclecontext
cn: DefaultSharedPinProfileEntry
orclappid: orclcommonpin
orclpwdverifierparams;orclpasswordverifier: crypto:MD5
orclpwdverifierparams;orclpasswordverifier: crypto:3DES
```

Use a command-line such as:

```
ldapmodify -D cn=orcladmin -q -p portNum -h hostname -f ldifFile
```

Delegating Privileges for Oracle Identity Management

This chapter explains how to store all the data for users, groups, and services in one repository, and delegate the administration of that data to various administrators. It also explains the default security configuration in Oracle Internet Directory.

This chapter contains these topics:

- [Introduction to Delegating Privileges for Oracle Identity Management](#)
- [Delegating Privileges for User and Group Management](#)
- [Delegating Privileges for Deployment of Oracle Components](#)
- [Delegating Privileges for Component Run Time](#)

Note: All references to Oracle Delegated Administration Services in this chapter refer to Oracle Delegated Administration Services 10g (10.1.4.3.0) or later.

Introduction to Delegating Privileges for Oracle Identity Management

Oracle Identity Management enables you to store all the data for users, groups, and services in one repository, and to delegate a particular administrator for each set of data. By providing both a centralized repository and customized delegated access, Oracle Identity Management is both secure and scalable.

This section contains these topics:

- [How Delegation Works](#)
- [Delegation in an Oracle Fusion Middleware Environment](#)
- [About the Default Configuration](#)
- [Privileges for Administering the Oracle Technology Stack](#)

How Delegation Works

Using the delegation model, a global administrator can delegate to realm administrators the privileges to create and manage the identity management realms for hosted companies. Realm administrators can, in turn, delegate to end users and groups the privileges to change their application passwords, personal data, and preferences. Each type of user can thus be given the appropriate level of privileges.

To delegate the necessary privileges, you assign the user to the appropriate administrative group. For example, suppose that you store data for both enterprise users and the e-mail service in the directory, and must specify a unique administrator for each set of data. To specify a user as the administrator of enterprise users, you assign that user to, say, the Enterprise User Administrators Group. To specify a user as the administrator of the e-mail services, you assign that user to, say, the E-mail Service Administrators Group.

Delegation in an Oracle Fusion Middleware Environment

Figure 31–1 shows the flow of delegation in an Oracle Fusion Middleware environment.

Figure 31–1 Delegation Flow in an Oracle Fusion Middleware Environment

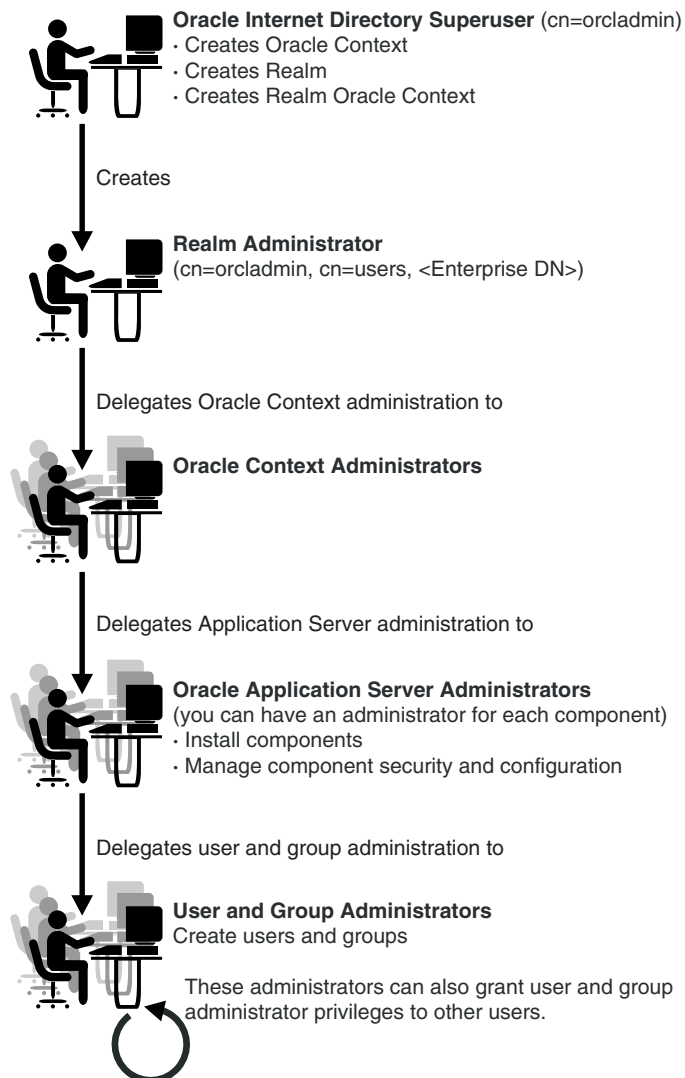

As Figure 31–1 on page 31-2 shows, in an Oracle Fusion Middleware environment the directory superuser (cn=orcladmin) creates:

- The Oracle Context
- The realm

- The realm-specific Oracle Context
- The entry for the realm administrator (`cn=orcladmin, cn=users, Enterprise DN`)

The realm administrator, in turn, delegates administration of the Oracle Context to specific users by assigning those users to the Oracle Context Administrators Group. Oracle Context Administrators then delegate administration of the Oracle Application Server to one or more users by assigning them to the Oracle Fusion Middleware Administrators Group. The Oracle Fusion Middleware Administrators install and administer Oracle Fusion Middleware components and delegate administration of user and group data to the User and Group Administrators group. The User and Group Administrators create users and groups. They can also grant user and group administrator privileges to other users.

About the Default Configuration

When you first install Oracle Internet Directory, the default configuration establishes access control policies at various points in the directory information tree (DIT). Default access controls are placed on the User and Group containers as described later in this chapter. Likewise, default privileges for specific directory entities are discussed later in this chapter. In addition, certain default privileges are granted to Everyone and to each user as described in [Table 31–2](#).

Table 31–1 Default Privileges Granted to Everyone and to Each User

Subject	Default Privileges
Everyone	The following privileges at the Root DSE: <ul style="list-style-type: none"> ■ Permission to browse user entries ■ Search, read, and compare access for all user attributes except the following <code>userpkcs12</code>, <code>orcluserpkcs12hint</code>, <code>userpassword</code>, <code>orclpassword</code>, and <code>orclpasswordverifier</code>
Each user	Complete access to his or her own attributes—including the <code>userpassword</code> , <code>orclpassword</code> , and <code>orclpasswordverifier</code> attributes.

You can customize this default configuration to meet the security requirements of your enterprise.

Privileges for Administering the Oracle Technology Stack

Administering the Oracle technology stack requires the privileges described in [Table 31–2](#).

Table 31–2 Privileges for Administering the Oracle Technology Stack

Type of Privilege	Description	More Information
User and group management privileges	These are delegated to either Oracle components that use the identity management infrastructure or to end users themselves	"Delegating Privileges for User and Group Management" on page 31-4
Deployment-time privileges	These are required to deploy any Oracle component. They may include privileges to create appropriate entries inside the directory, or to store metadata in a common repository. Such privileges must be given, for example, to an administrator of Oracle Portal.	"Delegating Privileges for Deployment of Oracle Components" on page 31-8
Run-time privileges	These are required to facilitate the run-time interactions of Oracle components within the identity management infrastructure. These include privileges to view user attributes, add new users, and modify the group membership. Such privileges must be given to the administration tool specific to each Oracle component, enabling it to access or create entries inside Oracle Internet Directory.	"Delegating Privileges for Component Run Time" on page 31-10

Caution: Be careful when modifying the default ACLs in any Oracle Context. Doing so can disable the security of Oracle components in your environment. See component-specific documentation for details on whether you can safely modify the default ACLs in an Oracle Context.

See Also: ["Introduction to Migrating Data from Other Data Repositories"](#) on page 36-1 if you have an existing directory structure that you now want to migrate to an Oracle Application Server environment

Delegating Privileges for User and Group Management

Administrative privileges are delegated to either Oracle components that use the identity management infrastructure or to end users themselves. A privilege can be delegated to either an identity—for example, a user or application—or to a role or group.

This section contains these topics:

- [How Privileges Are Granted for Managing User and Group Data](#)
- [Default Privileges for Managing User Data](#)
- [Default Privileges for Managing Group Data](#)

How Privileges Are Granted for Managing User and Group Data

To delegate administrative privileges, the Oracle Internet Directory superuser does the following:

1. Creates an identity management realm

2. Identifies a special user in that realm who is called the realm administrator
3. Delegates all privileges to that realm administrator

This realm administrator, in turn, delegates certain privileges that Oracle components require to the Oracle defined roles—for example, Oracle Fusion Middleware administrators. The Oracle components receive these roles when they are deployed.

In addition to delegating privileges to roles specific to Oracle components, the realm administrator can also define roles specific to the deployment—for example, a role for help desk administrators—and grant privileges to those roles. These delegated administrators can, in turn, grant these roles to end users. In fact, because a majority of user management tasks involve self-service—like changing a phone number or specifying application-specific preferences—these privileges can be delegated to end users by both the realm administrator and Oracle component administrators.

In the case of a group, one or more owners—typically end users—can be identified. If they are granted the necessary administrative privileges, then these owners can manage the group by using Oracle Internet Directory Self-Service Console, Oracle Directory Services Manager, or command-line tools.

Default Privileges for Managing User Data

Managing users involves privileges to:

- Create and delete user entries
- Modify user attributes
- Delegate user administration to other users

The access control policy point (ACP) for creating users is at the Users container in the identity management realm.

This section describes each of these privileges in more detail.

Creating Users for a Realm

To create users for a realm, an administrator must be a member of the Subscriber DAS Create User Group. [Table 31-3](#) describes the characteristics of this group.

Table 31-3 Characteristics of the Subscriber DAS Create User Group

Characteristic	Description
Default ACP	The ACL at the Users container in the default realm allows the Subscriber DAS Create User Group in the realm Oracle Context to create users under the Users container.
Administrators	The Oracle Internet Directory superuser Members of the Oracle Context Administrators Group Members of the User Privilege Assignment Group Members of the DAS Administrators Group Owners of this group
DN	<code>cn=oracleDASCreateUser, cn=groups, Oracle_Context_DN.</code>

Modifying Attributes of a User

To modify user attributes, an administrator must be a member of the Subscriber DAS Edit User Group. [Table 31-4](#) describes the characteristics of this group.

Table 31–4 Characteristics of the Subscriber DAS Edit User Group

Characteristic	Description
Default ACP	The ACL at the Users container in the default identity management realm allows the Subscriber DAS Edit User Group in the realm Oracle Context to modify various attributes of users.
Administrators	The Oracle Internet Directory superuser Members of the Oracle Context Administrators Group Members of the User Privilege Assignment Group Members of the DAS Administrators Group Owners of this group
DN	<code>cn=oracleDASEditUser, cn=groups, Oracle_Context_DN</code>

Deleting a User

To delete a user in a realm, an administrator must be a member of the DAS Delete User Group. [Table 31–5](#) describes the characteristics of this group.

Table 31–5 Characteristics of the DAS Delete User Group

Characteristic	Description
Default ACP	The ACL at the Users container in the default identity management realm allows the DAS Delete User Group in the realm Oracle Context to delete a user from the realm.
Administrators	The Oracle Internet Directory superuser Members of the Oracle Context Administrators Group Members of the User Privilege Assignment Group Members of the DAS Administrators Group Owners of this group
DN	<code>cn=oracleDASDeleteUser, cn=groups, Oracle_Context_DN</code>

Delegating User Administration

A delegated administrator can perform specified operations within the directory and requires permission to add any user to the User Creation, User Edit, or User Delete Groups described previously.

To grant user administration privileges to a delegate administrator, the granting administrator must be a member of the User Privilege Assignment Group. [Table 31–6](#) describes the characteristics of this group.

Table 31–6 Characteristics of the User Privilege Assignment Group

Characteristic	Description
Default ACP	The ACL policy for each of the groups previously mentioned allows members of the User Privilege Assignment Group to add users to or remove them from those groups.
Administrators	The Oracle Internet Directory superuser Oracle Context Administrators Group Owners of this group. The DNs of these owners are listed as values of the owner attribute in the group.
DN	<code>cn=oracleDASUserPriv, cn=groups, Oracle_Context_DN</code>

Default Privileges for Managing Group Data

Managing users and groups involves privileges to:

- Create and delete group entries
- Modify group attributes
- Delegate group administration to other users

The ACP for creating groups is at the Groups container in the identity management realm.

Creating Groups

To create groups in Oracle Internet Directory, an administrator must be a member of the Group Creation Group. [Table 31-7](#) describes the characteristics of this group.

Table 31-7 Characteristics of the Group Creation Group

Characteristic	Description
Default ACP	The ACL at the Groups container in the realm allows the Group Creation Group to add new groups in the realm.
Administrators	The Oracle Internet Directory superuser Members of the Oracle Context Administrators Group Members of the Oracle Fusion Middleware Administrators Group Members of the Group Privilege Assignment Group Members of the DAS Administrators Group Owners of this group
DN	<code>cn=oracleDASCreateGroup, cn=groups, Oracle_Context_DN</code>

Modifying the Attributes of Groups

To modify the attributes of groups under the Groups container in a realm, an administrator must be a member of the Group Edit Group. [Table 31-8](#) describes the characteristics of this group.

Table 31-8 Characteristics of the Group Edit Group

Characteristic	Description
Default ACP	The ACL at the Groups container in the realm allows the Group Edit Group to modify various attributes of groups in the realm.
Administrators	The Oracle Internet Directory superuser Members of the Oracle Context Administrators Group Members of the Oracle Fusion Middleware Administrators Group Members of Group Privilege Assignment Group Members of the DAS Administrators Group Owners of this group
DN	<code>cn=oracleDASEditGroup, cn=groups, Oracle_Context_DN</code>

Deleting Groups

To delete groups, an administrator must have membership in the Group Delete Group. [Table 31-9](#) describes the characteristics of this group.

Table 31–9 Characteristics of the Group Delete Group

Characteristic	Description
Default ACP	The ACL at the Groups container in the realm allows the Group Delete Group to delete groups in the realm.
Administrators	The Oracle Internet Directory superuser Members of the Oracle Context Administrators Group Members of the Group Privilege Assignment Group Members of the DAS Administrators Group Owners of this group
DN	<code>cn=oracleDASDeleteGroup, cn=groups, Oracle_Context_DN</code>

Delegating Group Administration

To delegate group administration to other users—that is, to add or remove users from the Group Creation, Group Edit, or Group Delete Groups described previously—an administrator must be a member of the Group Privilege Assignment Group.

[Table 31–10](#) describes the characteristics of this group.

Table 31–10 Characteristics of the Group Privilege Assignment Group

Characteristic	Description
Default ACP	The ACL policy for the Group Creation, Group Edit, or Group Delete Groups allows members of Group Privilege Assignment Group to add users to or remove them from those groups.
Administrators	The Oracle Internet Directory superuser Members of the Oracle Context Administrators Group Owners of the group. The DNs of these owners are listed as values of the owner attribute in the group.
DN	<code>cn=oracleDASUserPriv, cn=groups, Oracle_Context_DN</code>

Delegating Privileges for Deployment of Oracle Components

This section discusses the groups responsible for deploying Oracle components. It describes the tasks these administrators perform and the privileges they can grant. It includes these topics:

- [How Deployment Privileges Are Granted](#)
- [Oracle Application Server Administrators](#)
- [User Management Application Administrators](#)
- [Trusted Application Administrators](#)

Note: Oracle Internet Directory superusers have all the privileges of Oracle Fusion Middleware Administrators and Trusted Application administrators, and must be members of the Oracle Fusion Middleware Administrators Group. They can:

- Assign the Oracle Fusion Middleware Administrator role to a user
 - Assign the Trusted Application role to a user
 - Assign the User Management Application Administrator role to a user
-

How Deployment Privileges Are Granted

To enable administrators to deploy Oracle components, the superuser:

1. Grants certain deployment privileges to various groups—for example, the Oracle Fusion Middleware Administrators Group
2. Adds the administrators to those privileged groups

The delegated administrators, in turn, can delegate privileges to other administrators.

Oracle Application Server Administrators

Table 31–11 describes the characteristics of the Oracle Application Server Administrators Group.

Table 31–11 *Characteristics of the Oracle Application Server Administrators Group*

Characteristic	Description
Tasks	<p>Perform repository database installation that creates a repository database registration entry in the directory</p> <p>Perform mid-tier installation. To associate a mid-tier with a repository, the user must have the appropriate privileges with a specific repository database.</p> <p>Install and configure Oracle Fusion Middleware components that create application entities in Oracle Internet Directory</p> <p>Grant to component entities the run-time privileges listed later in this section</p> <p>Configure provisioning profiles for components so that the components can receive update notifications</p>
Privileges this group can delegate to components	<p>Read Common User Attributes—except passwords, certificates, and similar security credentials</p> <p>Read common group attributes</p> <p>Create, edit, and delete groups</p> <p>Authenticate a user</p> <p>Read application verifiers</p>
Administrators	<p>Oracle Internet Directory superuser</p> <p>Oracle Context Administrator</p> <p>Owners of this group</p>
DN	<code>cn=IASAdmins,cn=groups,Oracle_Context_DN</code>

User Management Application Administrators

User Management Application Administrators must be members of the Oracle Fusion Middleware Administrators Group.

Table 31–12 describes the characteristics of the User Management Application Administrators Group.

Table 31–12 Characteristics of the User Management Application Administrators Group

Characteristic	Description
Tasks	User Management Application administrators install specific applications that have interfaces to perform user management operations—for example, Oracle Portal and Oracle Application Server Wireless.
Privileges this group can delegate to components	Create, edit, and delete user attributes
Administrators	Oracle Internet Directory superuser Oracle Context Administrator Owners of this group
DN	<code>cn=IAS & User Mgmt Admins,cn=groups,Oracle_Context_DN</code>

Trusted Application Administrators

Trusted Application administrators must be members of the Oracle Fusion Middleware Administrators Group.

Table 31–13 describes the characteristics of the Trusted Application Administrators Group.

Table 31–13 Characteristics of the Trusted Application Administrators Group

Characteristic	Description
Tasks	Install specific identity management components—for example, Oracle Single Sign-On, Oracle Delegated Administration Services, and Oracle Application Server Certificate Authority
Privileges this group can delegate to components	Read, compare, or reset the user password Proxy as the end-user Read, compare, or modify the user's certificate and SMIME certificate
Administrators	Oracle Internet Directory superuser Oracle Context Administrator Owners of this group
DN	<code>cn=Trusted Application Admins,cn=groups,Oracle_Context_DN</code>

Delegating Privileges for Component Run Time

Many Oracle components administer user entries in Oracle Internet Directory and need the corresponding privileges. For example:

- When the Oracle Single Sign-On server authenticates a user, that server:
 - Connects to Oracle Internet Directory using its own identity

- Verifies that the password entered by the user matches that user's password stored in the directory

To do this, the Oracle Single Sign-On server needs permission to compare user passwords. To set up the Oracle Single Sign-On cookie, it needs permission to read user attributes.

- To grant access to a user, Oracle Portal must retrieve that user's attributes. To do this, it logs in to Oracle Internet Directory as a proxy user, impersonating the user seeking access. It therefore needs the privileges of a proxy user.

In general, Oracle components can require these privileges:

- Read and modify user passwords
- Compare user passwords
- Proxy on behalf of users accessing applications
- Administer the Oracle Context where all Oracle components store their metadata

Most Oracle components ship with a preconfigured set of privileges. You can change these default privileges to satisfy specific business requirements—for example, by removing privileges to create and delete user entries.

See Also: *Oracle Application Server Security Guide* in the 10g (10.1.4.0.1) library for further information about the component delegation model.

This section describes the security privileges required by Oracle components. It contains these topics:

- [Default Privileges for Reading and Modifying User Passwords](#)
- [Default Privileges for Comparing User Passwords](#)
- [Default Privileges for Comparing Password Verifiers](#)
- [Default Privileges for Proxying on Behalf of End Users](#)
- [Default Privileges for Managing the Oracle Context](#)
- [Default Privileges for Reading Common User Attributes](#)
- [Default Privileges for Reading Common Group Attributes](#)
- [Default Privileges for Reading the Service Registry](#)
- [Default Privileges for Administering the Service Registry](#)

Default Privileges for Reading and Modifying User Passwords

Reading and modifying user passwords requires administrative privileges on the security-related attributes in the directory—for example, the `userPassword` attribute. It requires membership in the User Security Administrators Group described in [Table 31-14](#).

Table 31–14 Characteristics of the User Security Administrators Group

Characteristic	Description
Default ACP	The default ACL policy at the Root (DSE Entry) allows members of the User Security Administrators Group to read, write, compare, and search on <code>userpkcs12</code> , <code>orclpkcs12hint</code> , <code>userpassword</code> , <code>orclpassword</code> , and <code>orclpasswordverifier</code> attributes at the Root Oracle Context. However, directory administrators can grant similar administrative privileges to the User Security Administrators Group in the realm Oracle Context.
Administrators	The Oracle Internet Directory superuser Members of the Oracle Context Administrators Group Members of the Trusted Application Administrators Group
DN	<code>cn=oracleUserSecurityAdmins,cn=groups,Oracle_Context_DN</code>

Default Privileges for Comparing User Passwords

Comparing user passwords requires permission to compare a user's `userPassword` attribute. This operation is performed by components such as Oracle Unified Messaging that authenticate end users by using their passwords stored in Oracle Internet Directory.

Comparing user passwords requires membership in the Authentication Services Group described in [Table 31–15](#).

Table 31–15 Characteristics of the Authentication Services Group

Characteristic	Description
Default ACP	The ACL policy at the Users container in the default identity management realm allows the Authentication Services Group to perform compare operation on the <code>userPassword</code> attribute of users.
Administrators	The Oracle Internet Directory superuser Members of the Oracle Context Administrators Group Members of the Application Server Administrators Group Owners of this group
DN	<code>cn=authenticationServices,cn=groups,Oracle_Context_DN</code>

Default Privileges for Comparing Password Verifiers

To compare password verifiers, a user must have permission to compare the `userpassword` attribute. Comparing password verifiers requires membership in the Verifier Services Group described in [Table 31–16](#).

Table 31–16 Characteristics of the Verifier Services Group

Characteristic	Description
Administrators	The Oracle Internet Directory superuser Members of the Oracle Context Administrators group Members of the Application Server Administrators group Owners of this group
DN	<code>cn=verifierServices,cn=groups,Oracle_Context_DN</code>

Default Privileges for Proxying on Behalf of End Users

A proxy user has the privilege to impersonate an end user, performing on that user's behalf those operations for which that user has privileges. In an Oracle Fusion Middleware environment, the Oracle Delegated Administration Services proxies on behalf of the end user, and, through the Oracle Internet Directory Self-Service Console, performs operations on that user's behalf. In such a case, the access controls on the directory server eventually govern the operations that the user can perform.

Proxying on behalf of end users requires membership in the User Proxy Privilege Group described in [Table 31-17](#).

Table 31-17 Characteristics of the User Proxy Privilege Group

Characteristic	Description
Default ACP	The ACL at the Users container in the default identity management realm allows User Proxy Privilege Group to proxy on behalf of the end user.
Administrators	The Oracle Internet Directory superuser Members of the Oracle Context Administrators Group Owners of the groups. The DNs of these owners are listed as values of the owner attribute in the group or members of the Oracle Fusion Middleware Administrators Group. Members of the Trusted Application Administrators Group
DN	<code>cn=userProxyPrivilege,cn=groups,OracleContextDN</code>

Default Privileges for Managing the Oracle Context

To manage a specific Oracle Context, a user must have complete access to it. Managing an Oracle Context requires membership in the Oracle Context Administrators Group described in [Table 31-18](#). An Oracle Context Administrators Group exists for each Oracle Context and has administrative permission in the specific Oracle Context.

Table 31-18 Characteristics of the Oracle Context Administrators Group

Characteristic	Description
Default ACP	The ACL policy at the root node of the Oracle Context allows members of Oracle Context Administrators Group to perform all administrative operations within the Oracle Context. Such a policy is set up when a new Oracle Context is created in the directory.
Administrators	The Oracle Internet Directory superuser Members of the Oracle Context Administrators Group
DN	<code>cn=oracleContextAdmins,cn=groups,Oracle_Context_DN</code>

Default Privileges for Reading Common User Attributes

Common user attributes are: `mail`, `orclguid`, `displayname`, `preferredlanguage`, `orcltime`, `gender`, `dateofbirth`, `telephonenumber`, `wirelessaccountnumber`. To read these attributes requires membership in the Common User Attributes Group described in [Table 31-19](#).

Table 31–19 Characteristics of the Common User Attributes Group

Characteristic	Description
Default ACP	The default ACL is on the User container in the realm and grants permission to read common user attributes.
Administrators	The Oracle Internet Directory superuser Members of the Application Server Administrators Group Owners of this group
DN	<code>cn=commonuserattributes,cn=users,Oracle_Context_DN</code>

Default Privileges for Reading Common Group Attributes

Common group attributes are: `cn`, `uniquemember`, `displayname`, and `description`. To read these attributes requires membership in the Common Group Attributes Group described in [Table 31–20](#) on page 31-14.

Table 31–20 Characteristics of the Common Group Attributes Group

Characteristic	Description
Default ACP	The default ACL is on the Group container in the realm and grants permission to read these attributes: <code>cn</code> , <code>uniquemember</code> , <code>displayname</code> , and <code>description</code> .
Administrators	The Oracle Internet Directory superuser Members of the Application Server Administrators Group Owners of this group
DN	<code>cn=commongroupattributes,cn=groups,Oracle_Context_DN</code>

Default Privileges for Reading the Service Registry

To view the contents of the Service Registry requires membership in the Service Registry Viewers Group described in [Table 31–21](#) on page 31-14.

Table 31–21 Characteristics of the Service Registry Viewers Group

Characteristic	Description
Default ACP	The default ACL is on the Services container in the root Oracle Context.
Administrators	The Oracle Internet Directory superuser Members of the Application Server Administrators Group Owners of this group
DN	<code>cn=service registry viewers,cn=services,cn=rootoraclecontext,</code>

Default Privileges for Administering the Service Registry

To administer the Service Registry requires membership in the Service Registry Administrators Group described in [Table 31–22](#) on page 31-14.

Table 31–22 Characteristics of the Common Group Attributes Group

Characteristic	Description
Default ACP	The default ACL is on the Services container in the root Oracle Context.

Table 31-22 (Cont.) Characteristics of the Common Group Attributes Group

Characteristic	Description
Administrators	The Oracle Internet Directory superuser Members of the Application Server Administrators Group Owners of this group
DN	<code>cn=service_registry</code> <code>admins,cn=services,cn=rootoraclecontext,</code>

Managing Authentication

This chapter gives a conceptual overview of Oracle Internet Directory authentication features. It contains these topics:

- [Introduction to Authentication](#)
- [Configuring SASL Authentication by Using Fusion Middleware Control](#)
- [Introduction to Anonymous Binds](#)
- [Managing Anonymous Binds](#)

Introduction to Authentication

Authentication is the process by which the directory server establishes the true identity of the user connecting to the directory. It occurs when an LDAP session is established with the bind operation. Thus every session has an associated user identity.

To verify the identities of users, hosts, and clients, Oracle Internet Directory enables three general kinds of authentication, and these are described in these topics:

- [Direct Authentication](#)
- [Indirect Authentication](#)
- [External Authentication](#)

Direct Authentication

This section describes the three kinds of direct authentication available within Oracle Internet Directory, and about how SASL-enabled clients authenticate to a directory server. The three kinds of direct authentication options are:

- Anonymous authentication

When users authenticate anonymously, they simply leave the user name and password fields blank when they log in. Each anonymous user then exercises whatever privileges are specified for anonymous users.
- Simple authentication

When using simple authentication, the client identifies itself to the server with a DN and a password that are not encrypted when sent over the network.
- Authentication by using Simple Authentication and Security Layer (SASL)

This is a method for adding authentication support to connection-based protocols. To use SASL, a protocol includes a command for identifying and authenticating a

user to a server and for optionally negotiating protection of subsequent protocol interactions. If the use of SASL is successfully negotiated, then a security layer is inserted between the protocol and the connection.

Oracle Internet Directory supports two authentication mechanisms with SASL:

- Digest MD5: The required authentication mechanism within LDAP Version 3 (RFC 2829). It uses the MD5 hash function to convert a message of any length to a 128 bit message digest that can be used as a verifier for client/server authentication.
- External authentication: Mechanism using SSL mutual authentication. In this case, the client, in lieu of a user name and password, authenticates to the server with a certificate, token, or some other device. Certificate authentication can take the following forms:
 - * Exact match: the subject DN in the client certificate is compared with the user DN in the directory. If the two values match, a bind occurs.
 - * Certificate hash: The client certificate is hashed and is then compared with the hashed value of the certificate stored in the directory. If the two values match and only one DN is associated with the pair, a bind occurs. If two or more DNs are associated, an error is returned because certificate hash and user DN is an n-to-1 mapping and not a 1-to-n mapping. That is, you can have many certificates associated with one DN, but only one DN associated with a certificate.
 - * Exact match/certificate hash: An exact-match search is performed first. If this search yields nothing, a certificate hash is performed.

To choose one of these methods, edit the DSA configuration parameter `orclpkimatchingrule` as prescribed in "Oracle Identity Management LDAP Attribute Reference" in *Oracle Fusion Middleware Reference for Oracle Identity Management*. (For authentication, an `orclpkimatchingrule` value of 3 or 4 is equivalent to a value of 2.)

Notes:

- The introduction in 10g (10.1.4.0.1) of a certificate hash value requires that user certificates be upgraded from earlier releases. To learn how to upgrade certificates, see the `upgradecert.pl` command-line tool reference in *Oracle Fusion Middleware Reference for Oracle Identity Management*.
 - You can search for the binary attribute `usercertificate`. To learn how to conduct a search, see [Appendix K, "Searching the Directory for User Certificates"](#).
 - The `usercertificate` attribute is intended to contain DER format certificates only.
-
-

See Also:

- [Simple Authentication and Security Layer \(SASL\)](#) on page 32-5
- The Web site of the Internet Engineering Task Force (IETF) at <http://www.ietf.org> for the following RFCs: RFC 2829, which specifies SASL Digest-MD5 as the required authentication mechanism for LDAP Version 3 servers; RFC 2831, which describes the Digest-MD5 mechanism; RFC 2617, which describes the HTTP Digest authentication mechanism on which SASL Digest-MD5 is based

Indirect Authentication

Indirect authentication occurs through any entity that has credentials in the directory—for example, an application such as the Oracle Internet Directory Self-Service Console, or a middle tier such as a firewall or a RADIUS server. The application or middle tier becomes a proxy user. A proxy user has the privilege to impersonate an end user, performing on that user's behalf those operations for which that user has privileges.

[Figure 32–1](#) and the accompanying text explain how indirect authentication takes place.

Figure 32–1 Indirect Authentication

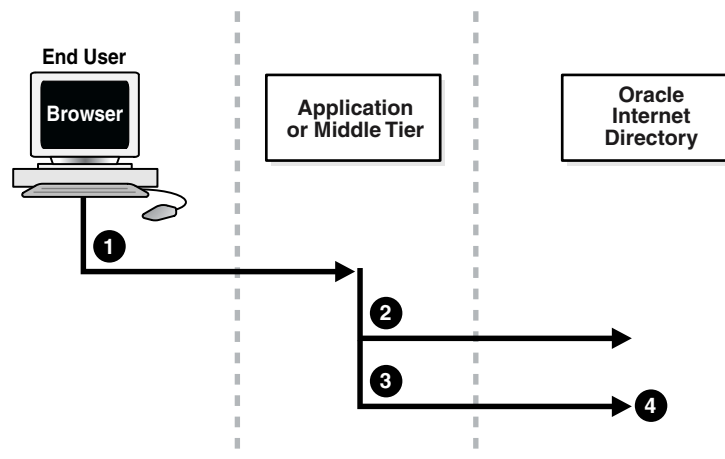

Indirect authentication takes place as follows:

1. The end user sends to the application or middle tier a request containing a query to Oracle Internet Directory. The application or middle tier authenticates the end user.
2. The application or middle tier binds to the directory.
3. The application or middle tier performs a second bind, this time using the DN of the end user. It does not enter the end user's password.
4. The directory server recognizes this second bind as an attempt by the application or middle tier to switch to the end user's identity. It trusts the authentication granted to the end user by the application or middle tier, but must verify that the application or middle tier has the right to be the proxy for this user. It checks to see whether the ACP governing the end user entry gives this application or middle tier the proxy right for this end user.

- If the end user entry does give the application or middle tier the necessary proxy right, then the directory server changes the authorization identity to that of the end user. All subsequent operations occur as if that end user had connected directly to the server and had been directly authenticated.
- If the end user entry does not give the application or middle tier the necessary proxy right, then the directory server returns an "Insufficient Access" error message.

See Also: [Operations: What Access Are You Granting?](#) on page 29-10

The directory server can, in the same session, authenticate and authorize other end users. It can also switch the session from the end user to the application or middle tier that opened the session.

To close the session, the application or middle tier sends an unbind request to the directory server.

For example, suppose you have:

- A middle tier that binds to the directory as `cn=User1`, which has proxy access on the entire directory
- An end user that can bind to the directory as `cn=User2`

When this end user sends to the application or middle tier a request containing a query to the directory, the application or middle tier authenticates the end user. The middle tier service then binds to the directory by using its own identity, `cn=User1`, then performs a second bind, this time by using only the DN of the end user, `cn=User2`. The Oracle directory server recognizes this second bind as an attempt by the proxy user to impersonate the end user. After the directory server verifies that `cn=user1` has proxy access, it allows this second bind to succeed. It does not require any further validation of the end-user DN, such as a password. For the rest of the session, all LDAP operations are access-controlled as if `cn=User2` were performing them.

If one user is being serviced by an application, and another user subsequently requests a service of that same application, then the application can establish a new connection and proceed as previously described without disrupting that prior session. If, however, no prior user is still being serviced, then the existing established connection can be re-used again and again without the need for a new connection.

External Authentication

Perhaps your enterprise stores user security credentials in a repository other than Oracle Internet Directory—for example, a database or another LDAP directory. With Oracle Internet Directory external authentication and password modification plug-ins, you can use these credentials for user authentication to Oracle components. You do not need to store the credentials in Oracle Internet Directory and then worry about keeping them synchronized.

See Also: [Chapter 44, "Configuring a Customized External Authentication Plug-in"](#)

Simple Authentication and Security Layer (SASL)

The section "[Direct Authentication](#)" on page 32-1 introduced the use of SASL within an Oracle Internet Directory environment. This section describes more fully how SASL works. It contains these topics:

- [How a SASL-Enabled Client Authenticates to a Directory Server by Using Digest-MD5](#)
- [How a SASL-Enabled Client Authenticates to a Directory Server by Using External Authentication](#)

How a SASL-Enabled Client Authenticates to a Directory Server by Using Digest-MD5

When a SASL-enabled client seeks Digest-MD5 authentication to a server, the authentication process is as follows:

1. The directory server sends to the LDAP client a digest-challenge that includes various Digest-MD5 authentication options that it supports and a special token.
2. The client selects an authentication option, then sends a digest-response to the server indicating the option it has selected. The response includes some secure tokens and a client credential in encrypted format. This allows it to authenticate itself to the server.
3. The directory server then decrypts and verifies the client credential from the response.

How a SASL-Enabled Client Authenticates to a Directory Server by Using External Authentication

Oracle Internet Directory provides SASL-external authentication over an SSL connection in which both client and server authenticate themselves to each other by providing certificates. The DN is derived from the client certificate used in the SSL network negotiation.

When a client seeks authentication to a directory server by using an external authentication mechanism such as SSL, the authentication process is as follows:

1. The client sends an initial message with the authorization identity.
2. The directory server uses information external to SASL to determine whether the client can validly authenticate as the authorization identity. If the client can validly authenticate, then the directory server indicates successful completion of the authentication exchange. Otherwise, the directory server indicates failure.

The system providing the external information may be IPsec or SSL/TLS. The authorization identity is derived as follows:

- In case of exact match, the authorization identity is derived from the client authentication credentials in the system providing external authentication—for example, the client SSL certificate.
- If the client sends an empty string as the authorization identity, then the authorization identity is derived from the client authentication credentials in the system providing external authentication—for example, the SSL certificate.

Configuring Certificate Authentication Method by Using Fusion Middleware Control

To configure the value of the DSA configuration parameter `orclPKIMatchingRule`, which determines the method used for certificate authentication, use the Oracle Internet Directory **Shared Properties** page of Oracle Enterprise Manager Fusion Middleware Control. Select **Administration**, then **Shared Properties** from the **Oracle Internet Directory** menu. Select the desired matching method from the list for PKI Matching Rule.

Configuring SASL Authentication by Using Fusion Middleware Control

To configure SASL Authentication by using Oracle Enterprise Manager Fusion Middleware Control:

1. Select **Administration**, then **Server Properties** from the **Oracle Internet Directory** menu, then select **SASL**.
2. Select the desired types for MD5 SASL Authentication Mode.
3. If you select Authentication with Integrity and Privacy Protection, you are presented with choices for SASL Cipher Choice for Privacy Protection. Select the desired types. Choices are: `rc4-56`, `des`, `3des`, `rc4`, and `rc4-40`. All five are enabled by default. At least `des` and `3des` must be configured, or SASL authentication fails.
4. If desired, select **Enable SASL Authentication**. Before enabling SASL Authentication, ensure that Oracle Internet Directory is configured to perform mutual authentication. See ["Configuring SSL by Using Fusion Middleware Control"](#) on page 26-5.
5. Choose **Apply**.

Restart the server after changing any of the parameters on the SASL tab.

Table 32-1 Configuration Attributes on Server Properties, SASL Tab

Field or Heading	Configuration Attribute
MD5 SASL Authentication Mode	<code>orclsaslauthenticationmode</code>
SASL Cipher Choice for Privacy Protection	<code>orclsaslcipherchoice</code>
External SASL Authentication Mode	<code>orclsaslmechanism</code>

Configuring Certificate Authentication Method by Using Command-Line Tools

To configure the value of the DSA configuration parameter `orclPKIMatchingRule`, which determines the method used for certificate authentication, use `ldapmodify`, with a command line similar to this

```
ldapmodify -D cn=orcladmin -q -p portNum -h hostname -f ldifFile
and with an LDIF file similar to this:
```

```
dn: cn=dsconfig, cn=configsets, cn=oracle internet directory
changetype: modify
replace: orclPKIMatchingRule
orclPKIMatchingRule: 1
```

The values are:

- 0 - Exact match. The PKI certificate DN must match the user entry DN.
- 1 - Certificate search. Check to see if the user has a PKI certificate provisioned into Oracle Internet Directory.
- 2 - A combination of exact match and certificate search. If the exact match fails, then a certificate search is performed.
- 3 - Mapping rule only. Use a mapping rule to map user PKI certificate DNs to Oracle Internet Directory DNs.
- 4 - Try in order: 1 (mapping rule), 2 (certificate search), 3 (exact match).

Configuring SASL Authentication by Using the Command Line

Table 32–2 lists the SASL authentication attributes. They reside in the instance-specific configuration entry.

Table 32–2 SASL Authentication Attributes

Attribute	Description	Default	Possible Values
<code>orclsslauthenticationmode</code>	SASL Authentication Mode	1	auth, auth-int, auth-conf.
<code>orclsslcipherchoice</code>	SASL Cipher Choice	Rc4-56,rc4-40,rc4,des,3des	Any combination of Rc4-56, des, 3des, rc4, rc4-40
<code>orclsslmechanism</code>	SASL Mechanism	DIGEST-MD5, EXTERNAL	DIGEST-MD5, EXTERNAL

MD5 SASL Authentication Mode is controlled by the attribute `orclsslauthenticationmode`. Table 32–3 lists the possible modes. You can specify all three values or any subset as a comma separated string.

Table 32–3 SASL Authentication Modes

<code>orclsslauthenticationmode</code> Value	Mode	Description
1	auth	Authentication only.
2	auth-int	Authentication with integrity protection. A checksum is performed on the channel.
3	auth-conf	Authentication with integrity protection and encryption. The channel is encrypted.

If you set `orclsslauthenticationmode` to 3 (`auth-conf`), you must also choose values for `orclsslcipherchoice`. Choices are: `rc4-56`, `des`, `3des`, `rc4`, and `rc4-40`. All five are enabled by default. At least `des` and `3des` must be configured, or SASL authentication fails.

The variable `orclsslmechanism` controls which authentication mechanisms are supported with SASL. The values `DIGEST-MD5` and `EXTERNAL` are set by default. Do not disable Digest-MD5 authentication. It is the required authentication mechanism for LDAP Version 3 servers. You can disable external authentication by using `ldapmodify`. Disable external authentication if you do not configure Oracle Internet Directory to perform SSL client and server authentication.

Restart the server after changing any of the SASL attributes.

Introduction to Anonymous Binds

An anonymous bind is one that uses simple authentication with no password. By default, the directory server allows anonymous bind, but allows only search operations on root DSE entry for anonymous users. You can configure the server to allow all anonymous binds or to disallow anonymous binds. This behavior is controlled by the `orclanonymousbindsflag` attribute of the `s` server instance-specific configuration entry. Table 32–4 lists the allowed values for `orclanonymousbindsflag` and the resulting directory server behavior.

Table 32–4 Orclanonymousbindsflag Value and Directory Server Behavior

<code>orclAnonymousBindsFlag</code> Value	Directory Server Behavior
0	Disallows anonymous bind
1	Allows anonymous bind
2	Allows anonymous bind but allows only search operations on root DSE entry for anonymous users (default)

Managing Anonymous Binds

In Oracle Internet Directory 11g Release 1 (11.1.1), anonymous binds are allowed by default, but anonymous users can only perform search operations on the root DSE entry. You can use either Fusion Middleware Control or the command line to change the server's behavior with respect to anonymous binds.

Managing Anonymous Binds by Using Fusion Middleware Control

To manage anonymous binds by using Oracle Enterprise Manager Fusion Middleware Control:

1. Select **Administration**, then **Server Properties** from the **Oracle Internet Directory** menu, then select the **General** tab.
2. From the **Anonymous Binds** list, select **Allows** to enable anonymous binds. Select **Disallow except for Read Access on the root DSE** to allow only search operations on root DSE entry for anonymous users.

To disable anonymous binds by using:

1. Select **Administration**, then **Server Properties** from the **Oracle Internet Directory** menu, then select the **General** tab.
2. From the **Anonymous Binds** list, select **Disallow**.

Managing Anonymous Binds by Using the Command Line

To enable all anonymous bind on the Oracle Internet Directory instance with componentName `oid1` using `ldapmodify`, you would type:

```
ldapmodify -D cn=orcladmin -q -p portNum -h hostname -f ldifFile
```

with an LDIF file such as:

```
dn: cn=oid1,cn=osldapd,cn=subconfigsentry
changetype: modify
replace: orclAnonymousBindsFlag
orclAnonymousBindsFlag: 1
```

To disable all anonymous binds, you would use a similar LDIF file with the last line changed to:

```
orclAnonymousBindsFlag: 0
```

See Also: [""Attributes of the Instance-Specific Configuration Entry"](#)
on page 9-2.

Part IV

Advanced Administration: Managing Directory Deployment

This part discusses important deployment considerations. It includes these chapters:

- [Chapter 33, "Planning, Deploying and Managing Realms"](#)
- [Chapter 34, "Tuning and Sizing Oracle Internet Directory"](#)
- [Chapter 35, "Managing Garbage Collection"](#)
- [Chapter 36, "Migrating Data from Other Data Repositories"](#)
- [Chapter 37, "Configuring Server Chaining"](#)

Planning, Deploying and Managing Realms

This chapter discusses identity management realms and how to plan and configure them for both enterprise and hosted deployments.

This chapter contains these topics:

- [Introduction to Planning, Deploying and Managing Realms](#)
- [Customizing the Default Identity Management Realm](#)
- [Creating Additional Identity Management Realms for Hosted Deployments](#)

Note: All references to Oracle Single Sign-On in this chapter refer to Oracle Single Sign-On 10g (10.1.4.3.0) or later.

Introduction to Planning, Deploying and Managing Realms

This introduction includes the following topics:

- [Planning the Identity Management Realm](#)
- [Identity Management Realms in an Enterprise Deployment](#)
- [Identity Management Realms in a Hosted Deployment](#)
- [Identity Management Realm Implementation in Oracle Internet Directory](#)
- [Default Directory Information Tree and the Identity Management Realm](#)

Planning the Identity Management Realm

[Chapter 5, "Understanding Oracle Internet Directory Organization"](#) describes guidelines for you to structure the overall DIT and the placement of users and groups for your deployment. Because implementing these guidelines can lead to an infinite number of deployment configurations, you must capture the intent of your deployment in metadata in the directory itself. This metadata enables Oracle software and other third-party software relying on the Oracle Identity Management infrastructure to understand the deployment intent and successfully function in customized environments.

In Oracle Internet Directory, this deployment intent is captured in the identity management realm. The realm also helps set identity management policies for users and groups whose placement is described in the previous section.

The identity management realm is a well-scoped area in the directory that consists of:

- A well-scoped collection of enterprise identities—for example, all employees in the US

- A collection of identity management policies associated with these identities
- A collection of groups—that is, aggregations of identities—that makes it easier to set identity management policies

When you have decided on the overall DIT structure and the placement of users and groups, you must identify the directory entry to serve as the root of the identity management realm. This entry determines the scope of the identity management policies defined in the realm. By default, the scope is the entire directory subtree under the root of the identity management realm. Under this entry, a special entry called `OracleContext` is created. It contains the following:

- The deployment-specific DIT design, including user and group naming and placement, as described in previous sections
- The identity management policies associated with this realm
- Additional realm-specific information specific to Oracle applications

When planning the identity management realm, consider the following:

- The security needs of your enterprise must dictate the choice of the root of the identity management realm. Typically, most enterprises need only one realm. However, multiple realms may be required when multiple user populations are managed with different identity management policies.
- If you already have a third-party directory, or plan to integrate with one in the future, then align the choice of the identity management realm root with the DIT design of the third-party directory. This simplifies the synchronization and subsequent administration of the distributed directories.
- To configure and administer identity management realms, use the administrative tools provided by Oracle Internet Directory. These include the Oracle Internet Directory Self-Service Console in Oracle Delegated Administration Services 10g (10.1.4.3.0) or later, and command-line tools.

See Also: The command reference for `oidrealm` in *Oracle Fusion Middleware Reference for Oracle Identity Management*.

- After you have used the Oracle Internet Directory tools to configure the identity management realm, plan on updating the directory naming and containment policies to reflect the customizations made by the deployment. This update must happen before installing and using other Oracle components that use the Oracle Identity Management infrastructure.

[Figure 33–1](#) shows an example of an identity management realm for an enterprise called MyCompany.

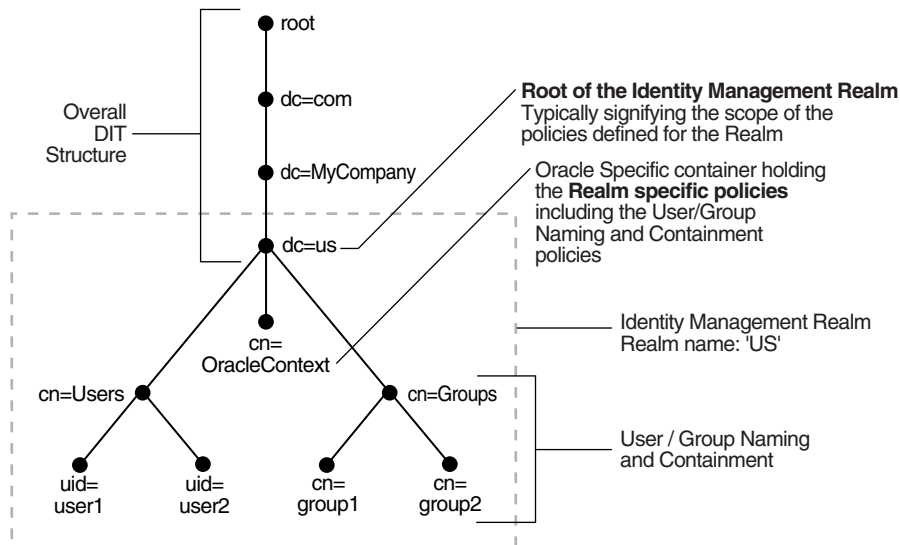
Figure 33–1 Example of an Identity Management Realm

In the example in [Figure 33–1](#), the deployment uses a domain name-based DIT structure. The container `dc=us`, `dc=mycompany`, `dc=com` is the root of the identity management realm. This results in the creation of a new identity management realm whose scope, by default, is restricted to the entire directory subtree under the entry `dc=us`. The name of the identity management realm is `US`.

Identity Management Realms in an Enterprise Deployment

This section discusses deployments with single identity management realms and those with multiple ones. It contains these topics:

- [Single Identity Management Realm in the Enterprise](#)
- [Multiple Identity Management Realms in the Enterprise](#)

Single Identity Management Realm in the Enterprise

In this scenario, an enterprise has a single set of users, all of whom are managed with the same identity management policies. This is the default configuration of all Oracle products. It includes only one default identity management realm in Oracle Internet Directory and all Oracle components in the enterprise serve users in that realm.

[Figure 33–2](#) illustrates this usage.

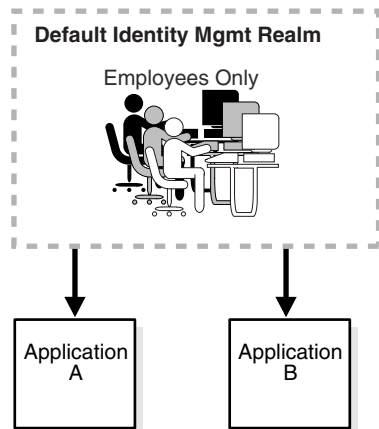
Figure 33–2 Enterprise Use Case: Single Identity Management Realm

In the example in [Figure 33–2](#), there is a single, default identity management realm containing employees only. In that realm all users and groups are managed and all share access to the same applications, Application A and Application B.

Multiple Identity Management Realms in the Enterprise

You can use the same identity management infrastructure to serve both internal and external self-registered users. Because the identity management policies for internal and external users are different, you can deploy two realms, one for internal and one for external users. [Figure 33–3](#) on page 33-4 illustrates this usage.

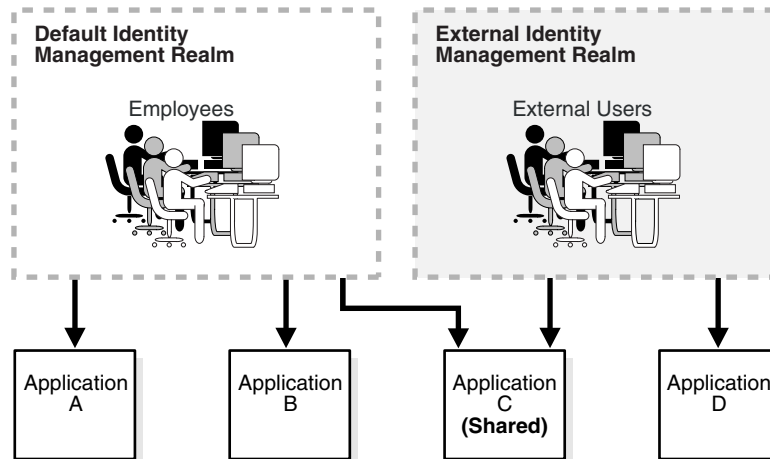
Figure 33–3 Enterprise Use Case: Multiple Identity Management Realms

In the example in [Figure 33–3](#), the default identity management realm is for internal users—namely, employees—and these have access to Applications A, B, and C. The external identity management realm is for external users, and they have access to Applications C and D.

Identity Management Realms in a Hosted Deployment

In a hosted deployment, the application service provider (ASP) supplies one or more companies with identity management services and hosts applications for them. Each hosted company is associated with a separate identity management realm where users

of that company are managed. Users belonging to the application service provider are managed in a different realm, typically the default realm.

Figure 33–4 shows a hosted deployment with two hosted companies.

Figure 33–4 Hosted Deployment Use Case

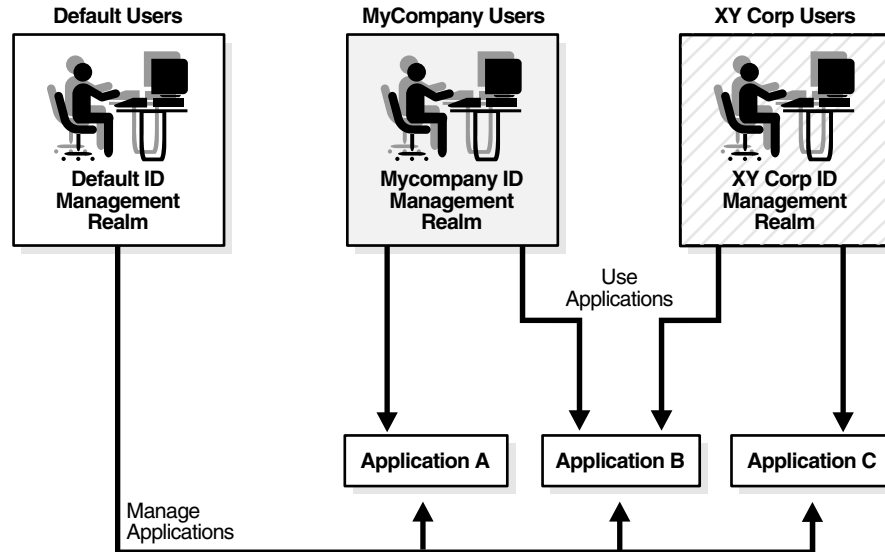

In the example in Figure 33–4, the ASP users are in the default identity management realm. The ASP manages its users, groups and associated policies in that realm. ASP users manage Applications A, B, and C for the hosted companies. Hosted company MyCompany users are in the Mycompany identity management realm. They use Applications A and B. Hosted company XY Corp users are in the XY Corp identity management realm. They use Applications B and C.

Identity Management Realm Implementation in Oracle Internet Directory

Table 33–1 describes the objects in an identity management realm.

Table 33–1 Oracle Identity Management Objects

Object	Description
Root Oracle Context	This object contains: <ul style="list-style-type: none"> ▪ A pointer to the default identity management realm in the infrastructure ▪ Information on how to locate a realm given a simple name of the realm
Identity Management Realm	A normal directory entry with a special object class associated with it.

Table 33–1 (Cont.) Oracle Identity Management Objects

Object	Description
Identity Management Realm-Specific Oracle Context	<p>In each realm, this object contains:</p> <ul style="list-style-type: none"> ■ User naming policy of the identity management realm—that is, how users are named and located ■ Mandatory authentication attributes ■ Location of groups in the identity management realm ■ Privilege assignments for the identity management realm—for example: who has privileges to add more users to the realm. ■ Application-specific data for that realm including authorizations

Default Directory Information Tree and the Identity Management Realm

To make configuration easier, Oracle Internet Directory, at installation, creates a default DIT and sets up a default identity management realm.

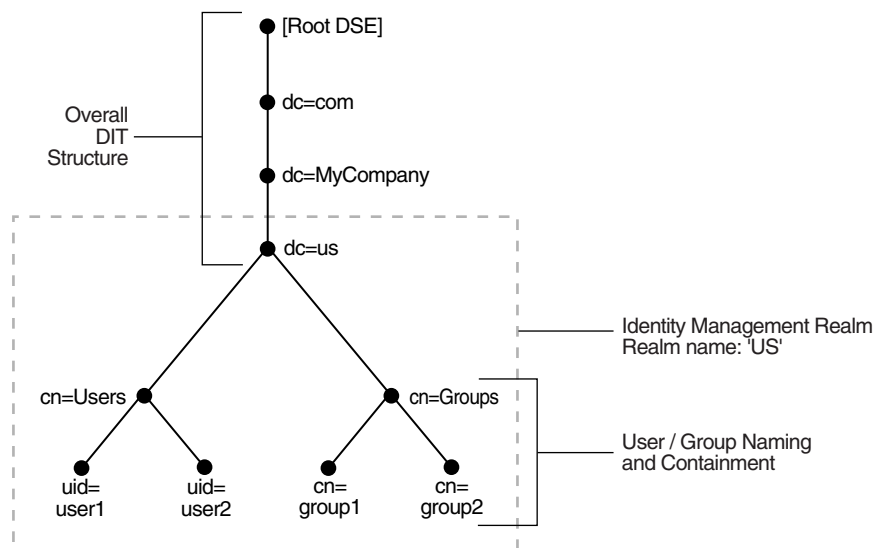
Figure 33–5 Default Identity Management Realm

As [Figure 33–5](#) shows, the default identity management realm is part of a global DIT. The node just below the root DSE is `dc=com`, followed by `dc=MyCompany`, then `dc=us`. These four nodes represent the overall DIT structure. The node `dc=us` is the root of the default identity management realm. It has two subtrees for containing user and group information: `cn=Users` and `cn=Groups`. For purposes of illustration, the `cn=Users` node contains two leaves: `uid=user1` and `uid=user2`. Similarly, the `cn=Groups` node contains `cn=group1` and `cn=group2`.

Oracle Internet Directory gives you the option of setting up a DIT based on the domain of the computer on which the installation is performed. For example, if the installation is on a computer named `oidhost.us.mycompany.com`, then the root of the default identity management realm is `dc=us,dc=mycompany,dc=com`.

It also gives you the option of specifying a different DN that meets your deployment needs as the root of your default identity management realm on the **Specify Namespace in Internet Directory** install screen. For example, if you plan to integrate your Identity Management installation with a third-party directory, it is recommended

that you specify a DN that matches the DN of the default naming context in the third-party directory. For more details on obtaining the default naming context from a third-party directory, refer to the chapter on integrating with third-party directories in *the Oracle Fusion Middleware Administrator's Guide for Oracle Directory Integration Platform*.

During configuration, Oracle Internet Directory creates the following:

- An Oracle Context associated with the default identity management realm. The Oracle Context stores all the realm-specific policies and metadata. Using the example in the previous paragraph, it creates the Oracle Context with the distinguished name `cn=OracleContext, dc=us, dc=mycompany, dc=com`. This entry and the nodes under it enable Oracle software to detect realm-specific policies and settings.
- A directory structure and naming policies in the default identity management realm. These enable Oracle components to locate various identities. The default values for these are:
 - All users are located in the container `cn=users` under the base of the identity management realm. In this example, it is `cn=users, dc=us, dc=mycompany, dc=com`.
 - Any new users created in the identity management realm using the Oracle Identity Management infrastructure are also created under the `cn=users` container.
 - All new users created in the identity management realm using the Oracle Identity Management infrastructure belong to the object classes `orclUserV2` and `inetOrgPerson`.
 - All groups are located in the container `cn=groups` under the base of the identity management realm. In this example, it is `cn=groups, dc=us, dc=mycompany, dc=com`.
- Identity management realm administrator. This user is located under the users container. In this example, the fully qualified DN of the realm administrator is `cn=orcladmin, cn=users, dc=us, dc=mycompany, dc=com`.

Note: If the realm administrator's account becomes locked, the Oracle Internet Directory superuser can unlock it by modifying the realm administrator's account password, using Oracle Directory Manager.

- Default authentication policies, which enable authentication services to perform the appropriate actions. These include:
 - The default directory password policy—for example, password length, lockout, and expiration
 - Additional password verifiers that need to be automatically generated when provisioning the user
- Identity management authorizations. Oracle Internet Directory grants these to the realm administrator who can further delegate these authorizations through the Oracle Internet Directory Self-Service Console. Some of these authorizations include:
 - Common identity management configuration privileges—for example, user creation, user profile modification, group creation

- Privileges to install new Oracle components by using the Oracle Identity Management infrastructure.
- Privileges to administer Oracle Internet Directory Self-Service Console

See Also:

- "Oracle Identity Management LDAP Object Classes" in *Oracle Fusion Middleware Reference for Oracle Identity Management* for more information about the `orclUserV2` object class
- [Chapter 31, "Delegating Privileges for Oracle Identity Management"](#) for a fuller description of the default access control policies in Oracle Identity Management

Customizing the Default Identity Management Realm

After a realm is created, you can further customize various aspects of it. [Table 33–2](#) lists the aspects you can customize, the tools available for each type of customization, and where to look for more information.

Table 33–2 Customizing the Default Identity Management Realm

What You Can Customize	Tools	Information
Directory structure and naming policies	Oracle Internet Directory Self-Service Console Oracle Directory Services Manager Command-line tools	This section. "Default Directory Information Tree and the Identity Management Realm" on page 33-6 The chapter on using the Oracle Internet Directory Self-Service Console in <i>Oracle Identity Management Guide to Delegated Administration</i> in the 10g (10.1.4.0.1) library
Authentication policies	Oracle Directory Services Manager Command-line tools	Chapter 28, "Managing Password Policies"
Identity management authorizations	Oracle Internet Directory Self-Service Console Oracle Directory Services Manager Command-line tools	Chapter 31, "Delegating Privileges for Oracle Identity Management" The chapter on using the Oracle Internet Directory Self-Service Console in <i>Oracle Identity Management Guide to Delegated Administration</i> in the 10g (10.1.4.0.1) library

A typical scenario where this might be required is one where you must integrate your Oracle Identity Management installation with a third-party directory.

For example, assume the default Identity Management Realm is `dc=mycompany, dc=com` and there are users under `cn=users, dc=mycompany, dc=com`.

If the third party directory naming context does not match the current user and group search base in the default realm, then you can alter the user and group search base of the default realm so that both the existing users and the third party users can log in using Oracle Single Sign-On. Select a user search base just high enough to include the existing users and the third party users. Let us call this search base the Lowest Common User Search Base.

Note: This approach assumes that the user `nickname` attribute selected for Oracle Single Sign-On Login is unique across the existing user search base and the third party directory naming context. Otherwise, Oracle Single Sign-On authentication fails for all those users whose `nickname` attribute values clash.

If your deployment scenario matches any of the use cases from 1 to 5, follow the procedure described in "[Steps to Update the Existing User and Group Search Base](#)" on page 33-10.

Use Case 1:

The third party naming context is under the default realm, but in a different container than the realm user search base

For example, the existing users are under `cn=users, dc=mycompany, dc=com` and the third party naming context is under `cn=users, o=employees, dc=mycompany, dc=com`. In this case, the Lowest Common User Search Base is `dc=mycompany, dc=com`.

Use Case 2:

The third party naming context is outside the default realm, but there is a Lowest Common User Search Base.

For example, the existing users are under `cn=users, dc=mycompany, dc=com` and the third party naming context is under `cn=users, dc=mycompanyecorp, dc=com`. In this case, the Lowest Common User Search Base is `dc=com`.

If the Lowest Common User Search Base is the root DSE, then use the procedures described for [Use Case 6](#):

1. "[Set up an Additional Search Base](#)" on page 33-11.
2. "[Refresh Oracle Single Sign-On](#)" on page 33-12.
3. "[Reconfigure Provisioning Profiles](#)" on page 33-12.

Use Case 3:

The third party naming context is the same as the default realm DN.

For example, the existing users are under `cn=users, dc=mycompany, dc=com` and the third party naming context is directly under `dc=mycompany, dc=com`. In this case, the Lowest Common User Search Base is `dc=mycompany, dc=com`.

Use Case 4:

The third party naming context contains the parent of the default realm DN.

For example, you might have a default realm with DN: `dc=us, dc=mycompany, dc=com`, existing users under `cn=users, dc=us, dc=mycompany, dc=com` and the third party naming context directly under `dc=com`. In this case, the Lowest Common User Search Base is `dc=com`.

Use Case 5:

The third party naming context is under the existing user search base.

For example, existing users are under `cn=users, dc=mycompany, dc=com` and the third party naming context is directly under

`l=emea, cn=users, dc=mycompany, dc=com`. In this case, the Lowest Common User Search Base is `cn=users, dc=mycompany, dc=com`. In this use case, you do not need to change the user search base.

Steps to Update the Existing User and Group Search Base

You must perform the following steps before you set up synchronization with the third party directory.

1. Back up the Oracle Internet Directory database.
2. Create the user and group containers for the third party directory, using Oracle Directory Services Manager, if the entries do not already exist in the directory.
3. Apply appropriate ACLs on the new users container by doing the following:
 - a. Instantiate the variables `%USERBASE%` and `%REALMBASE%` in the ACL template file `$ORACLE_HOME/ldap/schema/oid/oidUserAdminACL.sbs` and create the file `usrac1.ldif`. Set the variable `%USERBASE%` to the DN of the new user container and the variable `%REALMBASE%` to the default realm DN.
 - b. Upload the instantiated LDIF file `usrac1.ldif` using the `ldapmodify` command.
4. Apply appropriate ACLs on the new groups container by doing the following:
 - a. Instantiate the variables `%GRPBASE%` and `%REALMBASE%` in the ACL template file `$ORACLE_HOME/ldap/schema/oid/oidGroupAdminACL.sbs` and create the file `grpac1.ldif`. Set the variable `%USERBASE%` to the DN of the new user container and the variable `%REALMBASE%` to the default realm DN.
 - b. Upload the instantiated LDIF file `grpac1.ldif` using the `ldapmodify` command.
5. Determine a Lowest Common User Search Base base that is just high enough to include the existing users and the third party users.

For example, if existing users are under `cn=users, dc=mycompany, dc=com` and the third party users are under `l=emea, dc=mycompany, dc=com`, then the Lowest Common User Search Base is `dc=mycompany, dc=com`.

The Lowest Common User Search Base might be the root entry. That is the case if, for example, the existing users are under `cn=users, dc=mycompany, dc=com` and the third party users are under `dc=mycompanycorp, dc=net`. In that case, skip to the deployment scenario described in Use Case 6: "[Set up an Additional Search Base](#)" on page 33-11

6. If you must also synchronize groups, determine a group search base that is just high enough to include the existing groups and the third party groups. Lets call this search base the Lowest Common Group Search Base.

For example, if existing groups are under `cn=groups, dc=mycompany, dc=com` and the third party groups are under `l=emea, dc=mycompany, dc=com`, then the Lowest Common Group Search Base is `dc=mycompany, dc=com`.

7. log in to the Self-Service Console as the administrator of the realm (usually `orcladmin`).
8. Go to the **Configuration** tab and set the user search base to the Lowest Common User Search Base you determined in step 5. If you must also synchronize groups,

then also then set the group search base to the Lowest Common Group Search Base that you determined in step 6.

9. To make Oracle Single Sign-On recognize these changes, follow the procedure described under ["Refresh Oracle Single Sign-On"](#) on page 33-12.
10. Verify the Oracle Single Sign-On login of users in the original user search base by logging in as `orcladmin`.
11. You must also reconfigure the applications that have been provisioned to reflect the modified user and group bases. Follow the steps described under ["Reconfigure Provisioning Profiles"](#) on page 33-12.

Note: In addition to the user and group search base attributes, you can also modify other configuration settings of an identity management realm, such as the attribute for Login Name (nickname) or the attribute for RDN, using the Self-Service Console. See: ["Modifying Configuration Settings for an Identity Management Realm"](#) in the chapter ["Using the Oracle Internet Directory Self-Service Console"](#) of *Oracle Identity Management Guide to Delegated Administration* in the 10g (10.1.4.0.1) library for more details.

Use Case 6:

In this case, the third party naming context is outside the default realm and the Lowest Common User Search Base is the root DSE.

For example, if existing users are under `cn=users,dc=mycompany,dc=com` and the third party naming context is under `cn=users,dc=mycompanycorp,dc=net`, then the Lowest Common User Search Base is the root DSE.

In this case, you must add the third party naming context as an additional search base. The steps are as follows:

1. ["Set up an Additional Search Base"](#)
2. ["Refresh Oracle Single Sign-On"](#)
3. ["Reconfigure Provisioning Profiles"](#)

Set up an Additional Search Base

Perform the following steps before setting up synchronization with the third party directory.

1. Back up the Oracle Internet Directory database.
2. Create the user and group containers for the third party directory, using Oracle Directory Services Manager, if the entries do not already exist in the directory.
3. Apply appropriate ACLs on the new users container by doing the following:
 - a. Instantiate the variables `%USERBASE%` and `%REALMBASE%` in the ACL template file `$ORACLE_HOME/ldap/schema/oid/oidUserAdminACL.sbs` and create the file `usracl.ldif`. Set the variable `%USERBASE%` to the DN of the new user container and the variable `%REALMBASE%` to the default realm DN.
 - b. Upload the instantiated LDIF file `usracl.ldif` using the `ldapmodify` command.
4. Apply appropriate ACLs on the new groups container by doing the following:

- a. Instantiate the variables `%GRPBASE%` and `%REALMBASE%` in the ACL template file `$ORACLE_HOME/ldap/schema/oid/oidGroupAdminACL.sbs` and create the file `grpac1.ldif`. Set the variable `%USERBASE%` to the DN of the new user container and the variable `%REALMBASE%` to the default realm DN.
 - b. Upload the instantiated LDIF file `grpac1.ldif` using the `ldapmodify` command.
5. log in to the Self-Service Console as the administrator of the realm.
 6. Go the **Configuration** tab.
 - a. Add `cn=users,dc=mycompanycorp,dc=net` to the `usersearchbase` for the current realm.
 - b. Add `cn=groups,dc=mycompanycorp,dc=net` to the `groupsearchbase` for the current realm.
 7. To make Oracle Single Sign-On recognize these changes, follow the procedure described under ["Refresh Oracle Single Sign-On"](#) on page 33-12.
 8. Verify the Oracle Single Sign-On login of users in the original user search base by logging in as `orcladmin`.
 9. If mid-tiers have been configured against this identity management configuration, then you must also reconfigure the applications that have been provisioned to reflect the modified user and group bases. Follow the steps described under ["Reconfigure Provisioning Profiles"](#) on page 33-12.

Note: In addition to the user and group search base attributes, you can also modify other configuration settings of an identity management realm, such as the attribute for Login Name (nickname) or the attribute for RDN, using the Self-Service Console. See: "Modifying Configuration Settings for an Identity Management Realm" in the chapter "Using the Oracle Internet Directory Self-Service Console" of *Oracle Identity Management Guide to Delegated Administration* in the 10g (10.1.4.0.1) library for more details.

Refresh Oracle Single Sign-On

To make Oracle Single Sign-On recognize your configuration changes, execute the Oracle Single Sign-On refresh script by changing to the directory `$ORACLE_HOME/sso/admin/plsql/sso/` and typing:

```
sqlplus orasso@ssoreoid.sql
```

you are prompted for the password. To get the `orasso` schema password, refer to the appendix "Obtaining the Single Sign-On Schema Password" in the *Oracle Application Server Single Sign-On Administrator's Guide*.in the 10g (10.1.4.0.1) library.

Reconfigure Provisioning Profiles

If you installed middle-tier applications against this default identity management realm before changing its user and group search bases, then the provisioning profiles created by the middle-tier installations become invalid. This happens because the profiles have the old user or group search base information in the `eventsubscriptions` attribute. You must modify all the profiles by using `oidprovtool`.

Execute the following steps for every provisioning profile:

1. Use `ldapsearch` to put all the provisioning profile information into an LDIF file:

```
ldapsearch -h oid_host -p oid_port \
-D "cn=orcladmin" -q -s sub \
-b "cn=provisioning profiles,cn=changelog subscriber,\
cn=oracle internet directory" \
"objectclass=*" > provprofiles.ldif
```

The event subscriptions look something like this:

```
USER:cn=users,dc=mycompany,dc=com:MODIFY(list_of_attributes)
USER:cn=users,dc=mycompany,dc=com:DELETE
GROUP:cn=groups,dc=mycompany,dc=com:MODIFY(list_of_attributes)
GROUP:cn=groups,dc=mycompany,dc=com:DELETE
```

where `cn=users,dc=mycompany,dc=com` and `cn=groups,dc=mycompany,dc=com` are the user and group search bases, respectively, that were created when you installed and configured the application.

2. Get the actual DNs of the application identity by searching the Oracle Internet Directory server based on the GUID. To get the application DN, type:

```
ldapsearch -h host -p port -D cn=orcladmin -q \
-s sub -b "" \
"orclguid=Value_of_orcIODIPProvisioningAppGuid" dn
```

You can get the GUID values for each profile from the attribute values in `provprofiles.ldif`.

3. Modify each of the returned profiles as follows:

```
$ORACLE_HOME/bin/oidprovtool operation=MODIFY \
ldap_host=host ldap_port=port \

ldap_user_dn="cn=orcladmin" \

ldap_user_passwd=password \

interface_version=interfaceVersion \
application_dn=applicationDN \
organization_dn=identity_Realm_DN \
event_subscription=New_Event_Subscription_1
event_ subscription=New_Event_Subscription_2
.
.
.
event_subscription=New_Event_Subscription_n
```

The `New_Event_Subscription` arguments should be of the form:

```
USER: new_user_search_base:MODIFY(list_of_attributes)
USER: new_user_search_base:DELETE
GROUP: new_group_search_base:MODIFY(list_of_attributes)
GROUP: new_group_search_base:DELETE
```

Here, the `organization_dn` value should be the original identity realm DN

Creating Additional Identity Management Realms for Hosted Deployments

You can create additional identity management realms by using the Self-Service Console in Oracle Delegated Administration Services 10g (10.1.4.3.0) or later or by using `oidrealm`.

Only members of the ASPAdmins group can create a new identity management realm. Use Oracle Directory Services Manager to add a user to that group by adding the userDN to the `uniquemember` attribute of group ASPAdmins in the Default Identity Management Realm-specific OracleContext. Refer to the section on "Modifying a Static Group Entry by Using Oracle Directory Services Manager" for details.

Note: Not all applications can work with multiple identity management realms.

Whenever you add an additional realm, you may need to make existing applications aware of it by using a manual procedure. For more information, see the application-specific documentation.

In the Oracle Identity Management infrastructure, the single sign-on server must be made aware of an additional realm by using a special administrative procedure. Please refer to the chapter "Single Sign-On in Multiple Realms" in the *Oracle Application Server Single Sign-On Administrator's Guide* in the 10g (10.1.4.0.1) library for instructions on enabling multiple realms in Oracle Single Sign-On.

See Also:

- The `oidrealm` command reference in *Oracle Fusion Middleware Reference for Oracle Identity Management*.
- ["Modifying a Static Group Entry by Using Oracle Directory Services Manager"](#) on page 14-10.
- The chapter on the Oracle Internet Directory Self-Service Console in the *Oracle Identity Management Guide to Delegated Administration* in the 10g (10.1.4.0.1) library for information about creating an additional identity management realm.

Tuning and Sizing Oracle Internet Directory

Recommendations and procedures for sizing and tuning Oracle Internet Directory are documented in the Oracle Internet Directory chapter in the *Oracle Fusion Middleware Performance and Tuning Guide*.

Note: Oracle Internet Directory's out of box configuration is not optimal for most production or test deployments. You must follow at least the basic tuning steps listed in the Oracle Internet Directory chapter of *Oracle Fusion Middleware Performance and Tuning Guide* to achieve optimal performance and availability.



Managing Garbage Collection

The term "garbage" refers to any data not needed by the directory but still occupying space in it. This unwanted or obsolete data can eventually fill up the disk and decrease directory performance. The process of removing this unwanted data from the directory is called garbage collection.

This chapter contains these topics:

- [Introduction to Managing Garbage Collection](#)
- [Set Oracle Database Time Zone for Garbage Collection](#)
- [Modifying Oracle Internet Directory Garbage Collectors](#)
- [Managing Logging for Oracle Internet Directory Garbage Collectors](#)
- [Configuring Time-Based Change Log Purging](#)

Introduction to Managing Garbage Collection

A garbage collector is a background database process that removes unwanted data from the directory. The Oracle Internet Directory garbage collection framework provides a default set of garbage collectors, and enables you to modify them. The Oracle Internet Directory statistics collector also uses the Oracle Internet Directory garbage collection framework.

This introduction contains these topics:

- [Components of the Oracle Internet Directory Garbage Collection Framework](#)
- [How Oracle Internet Directory Garbage Collection Works](#)
- [Garbage Collector Entries and the Oracle Internet Directory Statistics Collector Entry](#)
- [Change Log Purging](#)

Components of the Oracle Internet Directory Garbage Collection Framework

This section describes the components that make up the Oracle Internet Directory garbage collection framework, namely, the garbage collection plug-in and the background database processes.

Garbage Collection Plug-in

Garbage collection in Oracle Internet Directory relies on a garbage collection plug-in that receives requests to manage garbage collectors. This plug-in is installed with

Oracle Internet Directory, and is enabled by default. The entry for this plug-in is `cn=plugin, cn=subconfigsentry`.

This plug-in has three triggers:

- The DN of the plug-in trigger used to create a garbage collection job is:
`cn=Add PurgeConfig, cn=plugin, cn=subconfigsentry`.
- The DN of the plug-in trigger used to modify a garbage collection job is:
`cn=Modify PurgeConfig, cn=plugin, cn=subconfigsentry`.
- The DN of the plug-in trigger used to delete a garbage collection job is:
`cn=Delete PurgeConfig, cn=plugin, cn=subconfigsentry`.

See Also: "Oracle Internet Directory Configuration Schema Elements" in *Oracle Fusion Middleware Reference for Oracle Identity Management* for a list and descriptions of the attributes of the garbage collection plug-in

Background Database Processes

The background database processes that are invoked by the garbage collection plug-in include garbage collectors and the Oracle Internet Directory statistics collector.

Garbage Collectors You can set and manage these behaviors of a garbage collector:

- The time it starts
- The age of the data you want it to purge
- How often it runs
- The type of data you want it to purge
- The number of entries to purge at a time

Predefined Garbage Collectors A default installation of Oracle Internet Directory includes these predefined garbage collectors:

- Change log garbage collector: Cleans up the consumed change log entries in the directory. The container for this garbage collector is
`cn=changelog purgeconfig, cn=purgeconfig, cn=subconfigsentry`.
- General statistics garbage collector: Cleans up obsolete entries created by Oracle Internet Directory Server Manageability for monitoring general statistics of the directory. The container for this garbage collector is
`cn=general stats purgeconfig, cn=purgeconfig, cn=subconfigsentry`.
- Health statistics garbage collector: Cleans up obsolete entries created by Oracle Internet Directory Server Manageability for monitoring health statistics of the directory. The container for this garbage collector is `cn=health stats purgeconfig, cn=purgeconfig, cn=subconfigsentry`.
- Security and refresh events garbage collector: Cleans up obsolete entries created by Oracle Internet Directory Server Manageability for monitoring security and refresh events of the directory. The container for this garbage collector is
`cn=secrefresh events purgeconfig, cn=purgeconfig, cn=subconfigsentry`.

- System resource events garbage collector: Cleans up obsolete entries created by Oracle Internet Directory Server Manageability for monitoring system resource events of the directory. The container for this garbage collector is `cn=sysresource events purgeconfig, cn=purgeconfig, cn=subconfigsubentry`.
- Tombstone garbage collector: Cleans up obsolete entries marked as deleted in the directory. The container for this garbage collector is `cn=tombstone purgeconfig, cn=purgeconfig, cn=subconfigsubentry`.
- LDAP performance monitoring garbage collector: Cleans up LDAP server performance statistics data. The container for this garbage collector is `cn=perf stats purgeconfig, cn=purgeconfig, cn=subconfigsubentry`.
- LDAP bind performance monitoring garbage collector: Cleans up bind performance data gathered for security events tracking. The container for this garbage collector is `cn=bindsec stats purgeconfig, cn=purgeconfig, cn=subconfigsubentry`.
- LDAP compare performance monitoring garbage collector: Cleans up compare performance data gathered for security events tracking. The container for this garbage collector is `cn=comparesec stats purgeconfig, cn=purgeconfig, cn=subconfigsubentry`.
- LDAP compare failure performance monitoring garbage collector: Cleans up compare failure performance data gathered for security events tracking. The container for this garbage collector is `cn=comparefailure stats purgeconfig, cn=purgeconfig, cn=subconfigsubentry`.

See Also:

- ["Capabilities of Oracle Internet Directory Server Manageability"](#) on page 24-1
- "Oracle Internet Directory Configuration Schema Elements" in *Oracle Fusion Middleware Reference for Oracle Identity Management*

Note: Oracle recommends that you not delete any of the predefined garbage collectors. Deleting one or more of them can result in the proliferation of obsolete data, eventually exhausting all the available disk space.

You may, however, modify predefined garbage collectors to customize their behavior.

Oracle Internet Directory Statistics Collector You can set and manage these behaviors of the Oracle Internet Directory statistics collector:

- The time it starts
- How often it runs

The Oracle Internet Directory statistics collector collects statistics about Oracle Internet Directory. The container for this background database process is `cn=oidstats_config, cn=purgeconfig, cn=subconfigsubentry`.

How Oracle Internet Directory Garbage Collection Works

Figure 35–1 shows an example of a garbage collector operation that purges change log entries.

Figure 35–1 Example: Garbage Collection of Change Log Entries

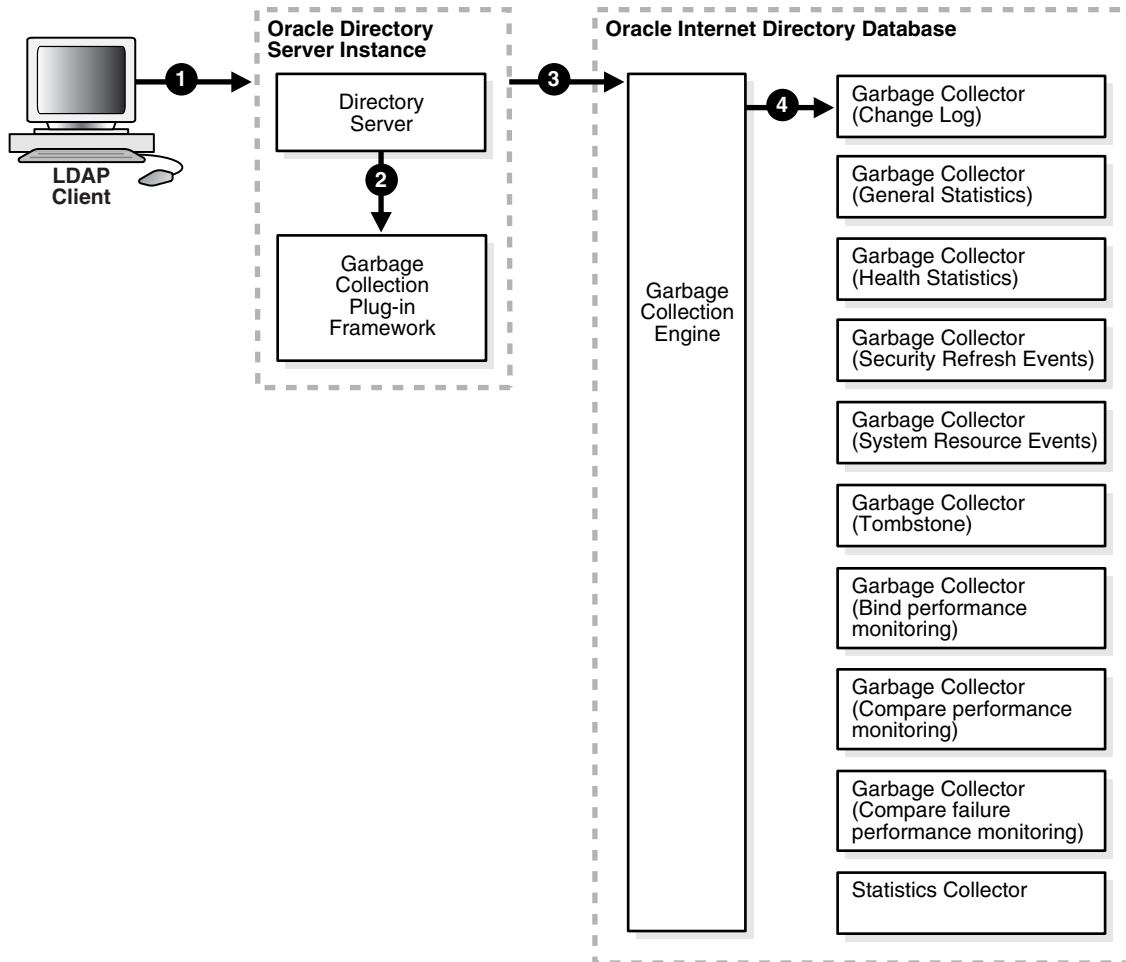

As the example in Figure 35–1 on page 35-4 shows, the garbage collection process is as follows:

1. An LDAP client sends to the directory server a request for a particular garbage collection operation. The operation could be, for example, to purge the entries of tombstone or, change logs.
2. The directory server passes the request to the garbage collection plug-in.
3. The garbage collection plug-in sends the request to the garbage collection engine in the Oracle Internet Directory-designated database.
4. The garbage collection engine triggers the corresponding background database process—in this case, the change log garbage collector. The background database process runs according to the parameters specified in its configuration.

Garbage Collector Entries and the Oracle Internet Directory Statistics Collector Entry

Garbage collector entries, each with attributes specifying how it is to behave, are located in the entry `cn=purgeconfig`, which is located immediately below the entry `cn=subconfigsubentry`.

See Also: "Oracle Internet Directory Configuration Schema Elements" in *Oracle Fusion Middleware Reference for Oracle Identity Management* for a description of each garbage collector attribute

The Oracle Internet Directory statistics collector entry, with its attributes, is also located in the entry `cn=purgeconfig`, immediately below the entry `cn=subconfigsubentry`.

Figure 35–2 shows the location of these entries.

Figure 35–2 Garbage Collection Entries in the DIT

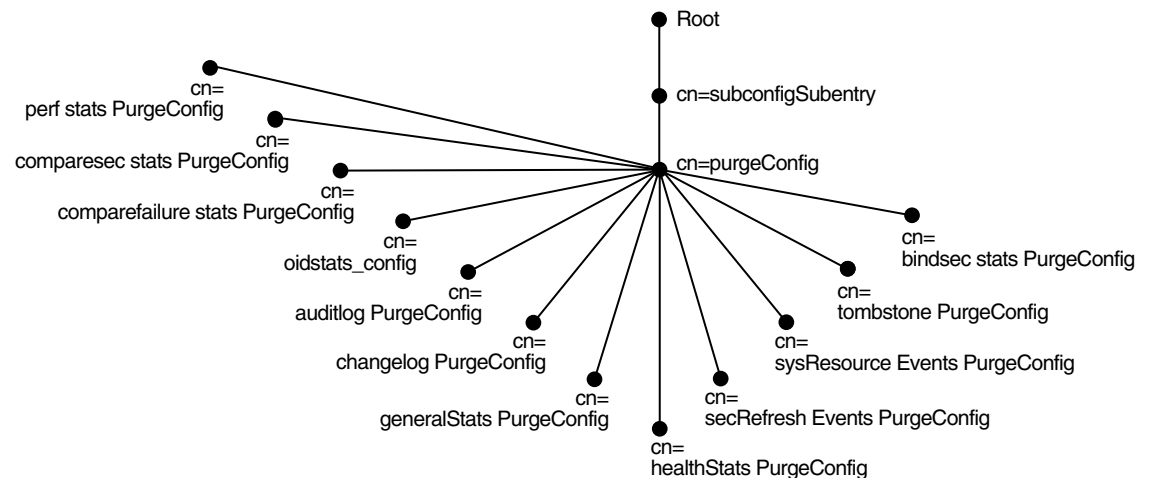

Change Log Purging

Both replication and Oracle Directory Integration Platform use change logs to propagate information from a supplier directory to a consumer directory. All change logs are stored in the table `ods_chg_log`. In addition, replication change logs are stored in `asr_chg_log`. When the change log garbage collector runs, it purges change logs that are no longer needed by any change log consumers. This prevents the change log store in the Oracle Internet Directory database from becoming too large.

The change log garbage collector uses the following two methods to determine which change logs to purge:

- Change number-based purging

Change number-based purging respects the change status of all change log consumers. That is, it does not purge change logs unless they have been consumed by all consumers. When the change log garbage collector runs, it purges all change logs that have been consumed by replication, Oracle Directory Integration Platform, and other consumers.

- Time-based purging

Time-based purging is a fall-back method designed to purge change logs of a certain age. It ensures that old change logs are purged even if they have not been

consumed by all change log subscribers. Time-based purging respects the change status of replication, but not the change status of other consumers. The change log garbage collector purges all change logs that are not needed by replication and that are at least `orclpurgetargetage` hours old. If `orclpurgetargetage` is zero, the change log garbage collector does this immediately. If `orclpurgetargetage` is an invalid number or not defined, the default value is 240 hours (10 days). Change logs needed by replication are not purged until they have been consumed by replication.

If you have deployed Oracle Directory Integration Platform, and you want to enable time-based purging, be sure to set `orclpurgetargetage` to a large enough value to allow change logs to be processed by Oracle Directory Integration Platform before they are purged. A value of 240 allows 10 days before change logs are purged.

See ["Configuring Time-Based Change Log Purging"](#) on page 35-9.

Set Oracle Database Time Zone for Garbage Collection

To ensure that the Oracle Internet Directory garbage collection logic works correctly, you must set the Oracle Database `dbtimezone` parameter to the appropriate displacement from Coordinated Universal Time (UTC). Proceed as follows:

1. Invoke PL/SQL:

```
$ sqlplus /nolog
SQL> connect / as sysdba
```

2. Perform a query to get the value of `dbtimezone`:

```
SQL> select dbtimezone from dual;
```

3. Perform a query to get the displacement from Coordinated Universal Time (UTC):

```
SQL> select systimestamp from dual;
```

The output will look similar to this:

```
SYSTIMESTAMP
-----
31-JAN-09 01.04.42.281000 PM -05:00
```

Get the last column of the `systimestamp` output. In the example, it is `-05:00`.

4. If the `dbtimezone` parameter is equal to last column value of the `systimestamp` output, you do not need to perform the remaining steps. Otherwise, proceed to Step 5.
5. Stop all instances of Oracle Internet Directory that are using the Oracle Database, as described in [Chapter 8, "Managing Oracle Internet Directory Instances."](#)
6. Set the `dbtimezone` parameter, using the value you got from the last column the `systimestamp` query:

```
SQL> ALTER DATABASE SET TIME_ZONE = '-05:00';
```

7. Shut down the Oracle Database:

```
SQL> shutdown immediate
```

8. Restart the Oracle Database:

```
SQL> startup
```

9. Restart Oracle Internet Directory as described in [Chapter 8, "Managing Oracle Internet Directory Instances."](#)

See Also: *Oracle OLAP DML Reference* for more information about the `dbtimezone` parameter.

Modifying Oracle Internet Directory Garbage Collectors

This section contains these topics:

- [Modifying a Garbage Collector by Using Oracle Directory Services Manager](#)
- [Modifying a Garbage Collector by Using Command-Line Tools](#)
- [Modifying the Oracle Internet Directory Statistics Collector](#)

Modifying a Garbage Collector by Using Oracle Directory Services Manager

To modify a garbage collector:

1. Invoke Oracle Directory Services Manager and connect to the Oracle Internet Directory server as described in "[Invoking Oracle Directory Services Manager](#)" on page 7-9.
2. From the task selection bar, select **Advanced**.
3. Expand **Garbage Collection** in the left pane, then select the garbage collector you want to modify. The Garbage Collector Window appears in the right pane.
4. In the **Garbage Collector** window, enter the changes you want to make for this garbage collector.
5. Choose **Apply**.

Modifying a Garbage Collector by Using Command-Line Tools

This section provides examples of how to modify garbage collectors by using command-line tools. The garbage collection attributes that you can modify are listed in "Oracle Internet Directory Configuration Schema Elements" in *Oracle Fusion Middleware Reference for Oracle Identity Management*.

Example 1: Modifying a Garbage Collector

Suppose that you want the tombstone garbage collector to run immediately. The LDIF would look like this:

```
dn: cn=tombstone purgeconfig, cn=purge config, cn=subconfigsubentry
changetype:modify
replace: orclpurgenow
orclpurgenow: 1
```

Load this entry with `ldapmodify`.

```
ldapmodify -D "cn=orcladmin" -q -h hostname -p port \
  -D username -f file_name_of_defined_entry
```

Example 2: Disabling a Garbage Collector Change Log

Suppose that you want to disable `changelog` garbage collector.

```
dn: cn=changelog purgeconfig, cn=purgeconfig, cn=subconfigsubentry
changetype: modify
replace: orclpurgeenable
orclpurgeenable: 0
```

Load this entry with ldapmodify.

```
ldapmodify -D "cn=orcladmin" -q -h hostname -p port \
-D username -f file_name_of_defined_entry
```

Modifying the Oracle Internet Directory Statistics Collector

You modify the Oracle Internet Directory statistics collector in the same way as the garbage collectors, but there are only three modifiable fields.

Managing Logging for Oracle Internet Directory Garbage Collectors

This section contains these topics:

- [Enabling Logging for Oracle Internet Directory Garbage Collectors](#)
- [Disabling Logging for Oracle Internet Directory Garbage Collectors](#)
- [Monitoring Garbage Collection Logging](#)

Enabling Logging for Oracle Internet Directory Garbage Collectors

If you enable logging for garbage collectors, then the directory server writes the information into a file in the file system. This information includes:

- The job identifier
- A job description of the garbage collector
- The number of entries purged
- The operation status
- The time stamp
- Any errors caught

To enable logging of garbage collection information:

1. Set the `orclpurgedebg` attribute to 1 if needed. When `orclpurgedebg` is set to 1, extra debugging detail information is logged. This is useful for troubleshooting garbage collection problems.
2. Set the `orclpurgefilename` attribute to a valid file name for the log file, for example: `oidgc001.log`.
3. Set the `orclpurgefileloc` attribute to the path name of the directory in which the log file is located, for example: `/private/qzhou/oracle/ldap/log`.
4. Enable PL/SQL I/O access to the directory specified in step 3. To do this, include the following in the database:

```
UTL_FILE_DIR=PATH_NAME
```

where `PATH_NAME` is the path you specified in Step 3.

See Also: The section on the `UTL_FILE_DIR` parameter type in the *Oracle Database Reference*

5. Shut down the replication server, then the Oracle Internet Directory server.
6. Restart the database.
7. Start the Oracle Internet Directory server, then the replication server.

Disabling Logging for Oracle Internet Directory Garbage Collectors

To disable logging of garbage collection information, set the `orclpurgedebug` attribute to 0.

Note: Even when `orclpurgedebug` is set to 0, minimal information about garbage collector operation is still logged to indicate the garbage collector's activities.

Monitoring Garbage Collection Logging

The information in the garbage collection log can be useful for monitoring and troubleshooting garbage collection. You determine the location of the log by setting attributes when enabling logging. For example, if you configured:

```
orclpurgefilename = oidgc001.log
orclpurgefileloc  = /private/qzhou/oracle/ldap/log
```

when you enabled logging, then you can monitor change log garbage collection activities by reading the file `/private/qzhou/oracle/ldap/log/oidgc001.log`.

The following is an example of the information logged when an administrator modified the `orclpurgenow` attribute of the change log garbage collection configuration entry:

```
Running Garbage Collector: cn=changelog purgeconfig
Starting time: 2005/03/24 11:03:23
PurgeConfig object located, Eid= 936
purge_ODSChglog: Nothing to be purged(no_work_to_do)
purge_ODSChglog: 107 chglogs successfully purged
purge_ASRChglog: Nothing to be purged(no_work_to_do)
purge_ASRChglog: 0 chglogs successfully purged
purge_ASRChglog: 0 chglogs successfully purged
```

```
Modifying Garbage Collector for at "2005/03/24 11:03:23
Garbage Collector DN recognized, rdn=cn=changelog purgeconfig
orclPurgeNow successfully retrieved.
Garbage Collector job found: jobno=21
Garbage Collector has been run
Garbage collector is updated successfully!
```

Modifying `orclpurgenow` forces the change log garbage collector to run immediately. As shown in the first paragraph, 107 change logs were purged from the `ods_chg_log` table and 0 change logs were purged from the `asr_chg_log` table. Also, the information in the second paragraph indicates successful modification of `orclpurgenow` attribute.

Configuring Time-Based Change Log Purging

Change log purging was described in "[Change Log Purging](#)" on page 35-5. You configure time-based purging by modifying the `orclpurgetargetage` attribute of

the changelog purging configuration entry. This example configures time-based purging for 120 hours (5 days). Use an LDIF file similar to this:

```
dn: cn=changelog purgeconfig,cn=purgeconfig,cn=subconfigsentry
changetype:modify
replace: orclpurgetargetage
orclpurgetargetage: 120
```

To apply the ldif file `mod.ldif`, type:

```
ldapmodify -D "cn=orcladmin" -q -p port -h host -D dn -q -f mod.ldif
```

Note: The container for the change log garbage collector is `cn=changelog purgeconfig, cn=purgeconfig, cn=subconfigsentry`.

See Also: "Oracle Internet Directory Configuration Schema Elements" in *Oracle Fusion Middleware Reference for Oracle Identity Management*

Migrating Data from Other Data Repositories

This chapter explains how to migrate data from both LDAP Version 3-compatible directories and application-specific data repositories into Oracle Internet Directory.

This chapter contains these topics:

- [Introduction to Migrating Data from Other Data Repositories](#)
- [Migrating Data from LDAP-Compliant Directories](#)
- [Migrating User Data from Application-Specific Repositories](#)

Introduction to Migrating Data from Other Data Repositories

During an Oracle Internet Directory installation, Oracle Identity Management 11g Installer creates a default schema and directory information tree (DIT). [Chapter 3, "Understanding Oracle Internet Directory Concepts and Architecture,"](#) and [Chapter 33, "Planning, Deploying and Managing Realms,"](#) describe this default DIT framework. The framework is flexible and you can modify it to suit the needs of your deployment.

In Oracle Internet Directory, the following directory elements are created by default:

- Root Oracle Context (`cn=OracleContext`): This is the container where Oracle products store enterprise-wide configuration data.
- Default identity management realm (`dc=dns_domain_of_host,dc=com`): This is the container under which Oracle products expect to find enterprise users and groups. It approximates the enterprise DIT structure. For example, if Oracle Internet Directory is installed on a computer whose host name is: `my_computer.us.my_company.com`, then the default identity management realm created at installation of Oracle Internet Directory would be `dc=us,dc=my_company,dc=com`. Oracle products expect to find all users under the container `cn=users,dc=us,dc=my_company,dc=com` and all groups under `cn=groups,dc=us,dc=my_company,dc=com`. In addition to creating the default identity management realm entry, the Oracle Internet Directory Configuration Assistant stores a pointer to it in the Root Oracle Context so that other Oracle Internet Directory-enabled components can bootstrap themselves.

You can change this default identity management realm to suit your deployment requirements.

Migrating Data from LDAP-Compliant Directories

This section provides practical information for migrating data from an LDAP-compliant, third-party directory to Oracle Internet Directory. If you have a directory with an already-established structure, and you want to migrate the data from

that directory into the default directory structure environment, then follow the instructions in this section.

Two tools that are commonly used for migrating data are `bulkload` and `syncProfileBootstrap`. [Table 36-1, "Features of bulkload and syncProfileBootstrap"](#) lists the features of `bulkload`, as compared with `syncProfileBootstrap`.

Table 36-1 Features of bulkload and syncProfileBootstrap

Feature	bulkload	syncProfileBootstrap
Speed	Fast	Slow
Data transfer method	SQL	LDAP
Input types accepted	LDIF file only	LDIF file, LDAP directory, tagged file, CSV file
Transforms data	No	Yes
Validates LDIF input	Yes	No

See Also:

- "Oracle Internet Directory Data Management Tools" in *Oracle Fusion Middleware Reference for Oracle Identity Management* for `bulkload` syntax information and examples,
- *Oracle Fusion Middleware Administrator's Guide for Oracle Directory Integration Platform* for more information about `syncProfileBootstrap`.

Migrating LDAP Data by Using an LDIF File and bulkload

The bulk loader, `bulkload`, is a command-line tool for loading a large number of entries into a directory server. It uses Oracle SQL*Loader to load the directory entries. The `bulkload` tool expects the input file to be in LDAP Data Interchange Format (LDIF). The `bulkload` tool can validate LDIF input for referential integrity, but it cannot perform any mapping or other transformation on the data.

When no translation is required and data is very large (500,000 or more), `bulkload` is the best choice for migrating data from a third-party directory to Oracle Internet Directory. It is fast and it can validate LDIF input.

To use this method, you must first export data from the third-party directory to an LDIF file, as shown in [Figure 36-1, "Using an LDIF File and bulkload"](#).

Figure 36-1 Using an LDIF File and bulkload

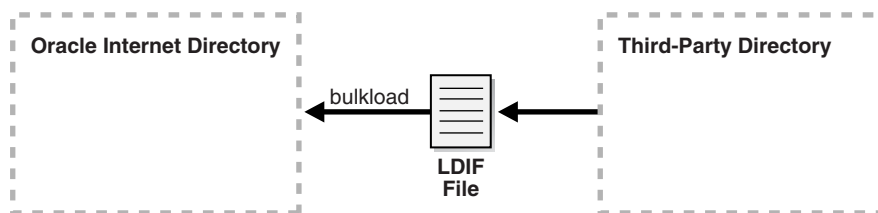

LDIF is the IETF-sanctioned ASCII interchange format for representing LDAP-compliant directory data as a file. All LDAP-compliant directories should have tools to export their contents into one or more LDIF files representing the DIT at the time of export.

See Also: RFC 2849 of the IETF, available for download at:
<http://www.ietf.org>

When using an LDIF file and bulkload to migrate data to Oracle Internet Directory, you must perform the following tasks.

Task 1: Export Data from the Non-Oracle Internet Directory Server into LDIF File Format

See the vendor-supplied documentation for instructions. If flags or options exist for exporting data from the foreign directory, be sure to select the method that:

- Produces LDIF output with the least amount of proprietary information included
- Provides maximum conformance to the IETF Request for Comments 2849 of the IETF, available for download at: <http://www.ietf.org>

Task 2: Analyze the LDIF User Data for Any Required Schema Additions Referenced in the LDIF Data

Any attributes not found in the Oracle Internet Directory base schema require extension of the Oracle Internet Directory base schema before the importation of the LDIF file. Some directories may support the use of configuration files for defining extensions to their base schema (Oracle Internet Directory does not). If you have a configuration file you can use it as a guideline for extending the base schema in Oracle Internet Directory in "[Task 3: Extend the Schema in Oracle Internet Directory](#)".

Task 3: Extend the Schema in Oracle Internet Directory

See [Chapter 20, "Managing Directory Schema"](#) for tips on how to extend the directory schema in Oracle Internet Directory. You can do this by using either Oracle Directory Services Manager or the SchemaSynch tool, which is documented in *Oracle Fusion Middleware Reference for Oracle Identity Management*.

If you have users who are using other Oracle products, you must create users with object class `orclUserV2` and its required attributes. If you are integrating with Active Directory, you must create users with object class `orclADUser` and its required attributes. These object classes and their attributes are documented in *Oracle Fusion Middleware Reference for Oracle Identity Management*.

Task 4: Remove Any Proprietary Directory Data from the LDIF File

Certain elements of the LDAP v3 standard have not yet been formalized, such as ACI attributes. As a result, various directory vendors implement ACI policy objects in ways that do not translate well across vendor installations.

After the basic entry data has been imported from the cleaned up LDIF file to Oracle Internet Directory, you must explicitly reapply security policies in the Oracle Internet Directory environment. You can do this by using either Oracle Directory Services Manager, or command-line tools and LDIF files containing the desired ACP information.

There may be other proprietary metadata unrelated to access control. You should remove this as well. Understanding the various IETF RFCs can help you determine which directory metadata is proprietary to a given vendor and which complies with the LDAP standards, and is thus portable by way of an LDIF file.

Task 5: Remove Operational Attributes from the LDIF File

Four of the standard LDAP v3 operational attributes, namely, `creatorsName`, `createTimestamp`, `modifiersName`, and `modifyTimestamp` are automatically

generated by Oracle Internet Directory whenever entries are created or imported. It is not possible to instantiate these values from existing directory data, for example by using LDIF file importation. Therefore you should remove these attributes from the file before attempting to import.

Task 6: Remove Incompatible userPassword Attribute Values from the LDIF File

The userPassword attribute hash algorithms supported by Oracle Internet Directory are listed in the `orclcryptoscheme` entry in "[Attributes of the DSE](#)" on page 9-10.

The userPassword attribute hash values used by some vendor products are not compatible with Oracle Internet Directory. As a result, you must remove all lines corresponding to the userPassword attribute and value from the LDIF data file unless they are represented in plain text or contain no value. After importation of the LDIF data, you must manually reenter or upload hashed userPassword information separately into the directory. Be sure that the passwords comply with the Oracle Internet Directory password policies and are in clear text.

Task 7: Run the bulkload check =TRUE" Mode and Determine Any Remaining Schema Violations or Duplication Errors

Before generating and loading an LDIF file, always perform a check on it by using the bulkload utility check mode. The bulkload output reports any inconsistencies in the data.

See Also: The `bulkload` command-line tool reference in *Oracle Fusion Middleware Reference for Oracle Identity Management* for instructions on how to use the bulkload check mode

Migrating LDAP Data by Using `syncProfileBootstrap` Directly

The Directory Integration Assistant, `syncProfileBootstrap`, is a command-line tool for administering the synchronization profiles scheduled by the Oracle directory integration server. An administrator can use the `syncProfileBootstrap` operation to perform the initial migration of data between a connected directory and Oracle Internet Directory when configuring the Oracle directory integration server to perform ongoing synchronization. You also use it for a one-time data migration, without ongoing synchronization.

The `syncProfileBootstrap` operation can take data either directly from a third-party LDAP-compliant directory or from an LDIF file, tagged file, or CSV file. You must provide mapping rules, either as a synchronization profile or in a configuration file.

For `syncProfileBootstrap` syntax information, configuration file properties, information about input file types, and examples, see "Oracle Directory Integration PlatformTools" in *Oracle Fusion Middleware Reference for Oracle Identity Management* and *Oracle Fusion Middleware Administrator's Guide for Oracle Directory Integration Platform*.

If you must perform mapping when migrating the data from the third-party directory to Oracle Internet Directory, and if the data is small in size, you can use `syncProfileBootstrap`. As shown in [Figure 36-2, "Using syncProfileBootstrap Directly"](#), you can use the third-party directory itself as input to `syncProfileBootstrap`.

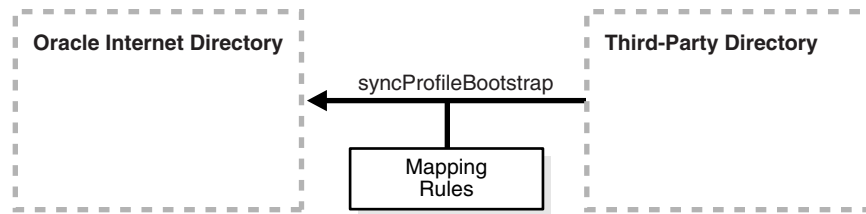
Figure 36–2 Using syncProfileBootstrap Directly

Migrating LDAP Data by Using an LDIF File and syncProfileBootstrap

Scenario 3 is a variation on Scenario 2. If you do not have direct access to the third-party directory, you can have the administrator export the data to an LDIF file. As shown in [Figure 36–3, "Using an LDIF File and syncProfileBootstrap"](#), syncProfileBootstrap can take its input from an LDIF file. You could also use Oracle directory integration server to migrate the data.

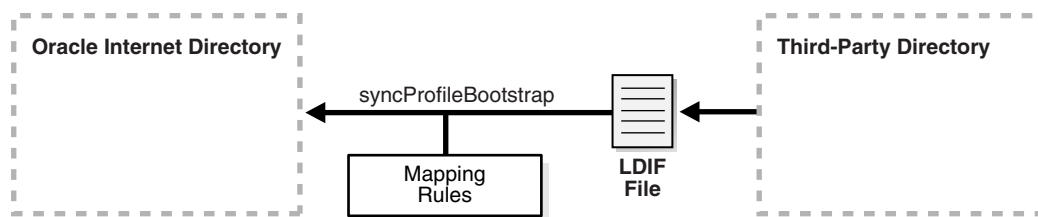
Figure 36–3 Using an LDIF File and syncProfileBootstrap

Whenever you use an LDIF file and bulkload to migrate data to Oracle Internet Directory, you must perform certain tasks. In this scenario, you are using a mapping file with syncProfileBootstrap or Oracle Directory Integration Platform, so do not have to perform all the tasks listed in ["Migrating LDAP Data by Using an LDIF File and bulkload"](#). You only have to perform the following tasks:

- [Task 1: Export Data from the Non-Oracle Internet Directory Server into LDIF File Format](#)
- [Task 2: Analyze the LDIF User Data for Any Required Schema Additions Referenced in the LDIF Data](#)
- [Task 3: Extend the Schema in Oracle Internet Directory](#)

Migrating LDAP Data by Using syncProfileBootstrap, bulkload, and LDIF Files

If you have a large amount of data and you must perform mapping on the data, you can use a combination of tools. As shown in [Figure 36–4, "Using syncProfileBootstrap, bulkload, and LDIF Files"](#), you can export the data from the third-party directory to an LDIF file, then use syncProfileBootstrap to perform the mapping into another LDIF file, which you then load with bulkload.

Figure 36–4 Using syncProfileBootstrap, bulkload, and LDIF Files

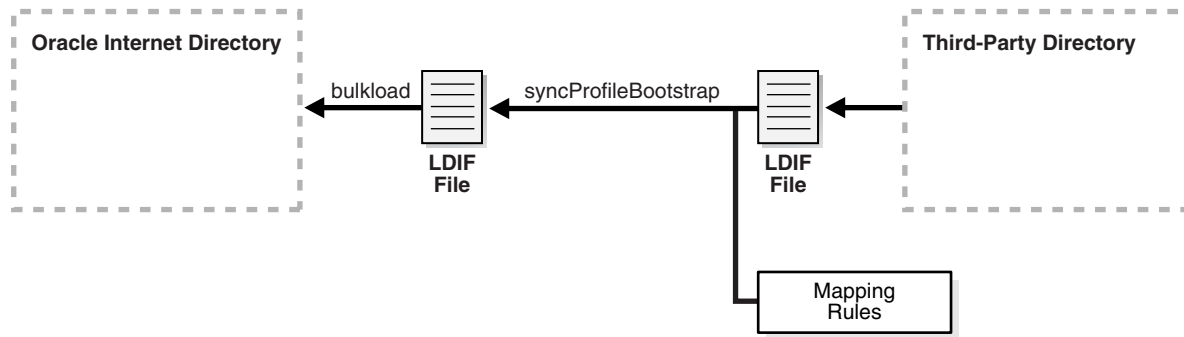

As in [Migrating LDAP Data by Using an LDIF File and syncProfileBootstrap](#), you only have to perform these tasks:

- [Task 1: Export Data from the Non-Oracle Internet Directory Server into LDIF File Format](#)
- [Task 2: Analyze the LDIF User Data for Any Required Schema Additions Referenced in the LDIF Data](#)
- [Task 3: Extend the Schema in Oracle Internet Directory](#)

Migrating LDAP Data by Using the Oracle Directory Integration Platform Server

Under some circumstances, an administrator might choose not to use `syncProfileBootstrap` when configuring the Oracle directory integration server. After it is configured, the Oracle directory integration server itself can migrate data from a connected directory to Oracle Internet Directory. You can also use the Oracle directory integration server for a one-time data migration. For more information, see *Oracle Fusion Middleware Administrator's Guide for Oracle Directory Integration Platform*.

The Oracle directory integration server enables you to configure bidirectional, ongoing integration between Oracle Internet Directory and a Third-party directory, as shown in [Figure 36–5, "Using the Oracle Directory Integration Server"](#). For more information, see *Oracle Fusion Middleware Administrator's Guide for Oracle Directory Integration Platform*.

Figure 36–5 Using the Oracle Directory Integration Server

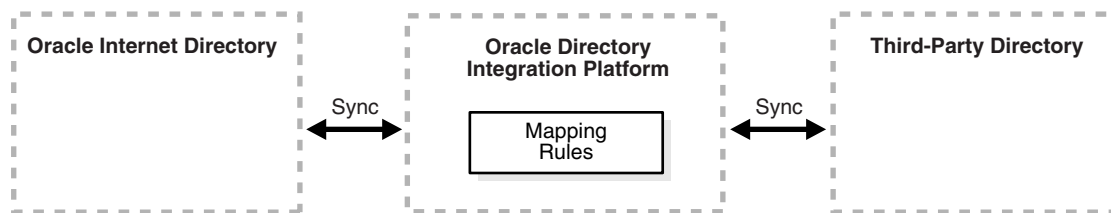

Migrating User Data from Application-Specific Repositories

Migrating user data from an application-specific repository requires:

- Collecting the user data from the application-specific repository and formatting it in a way that the directory can read it
- Making that data available to the directory administrator who must then:
 - Specify where to place it in the directory

- Import it into the directory

The Intermediate Template File

To enable this migration to happen, the Oracle Directory Provisioning Integration Service requires the application-specific repository to export its data to an intermediate template file. Records in this template file are not in pure LDIF; they contain substitution variables that have to do with, for example, the location in the directory where the information is finally to reside. The application leaves these variables undefined, so that you, the directory administrator can define them later on.

To convert the user data from this intermediate template file into proper LDIF, you use the OID Migration Tool (`ldifmigrator`). After the data is converted to LDIF, you can load it into the directory.

To summarize: Migrating data from application-specific repositories involves these general steps:

1. Exporting the application-specific data as an intermediate template file
2. You, the directory administrator, using the OID Migration Tool (`ldifmigrator`) to read these partial LDIF entries and convert them to pure LDIF entries based on the deployment choices
3. You, the directory administrator, loading the data, now in pure LDIF, into Oracle Internet Directory
4. The application completing the migration process according to its own specifications

Reconciling Data in Application Repository with Data Already in the Directory

The data you are migrating from an application-specific repository may already reside in Oracle Internet Directory. If this is the case, then you can reconcile differences between the two directories by using the reconciliation feature of the OID Migration Tool (`ldifmigrator`).

See Also: The `ldifmigrator` command-line tool reference in *Oracle Fusion Middleware Reference for Oracle Identity Management* for information about the reconciliation feature of the OID Migration Tool

Tasks For Migrating Data from Application-Specific Repositories

To migrate data from application-specific repositories, you create an intermediate template file, then run the OID Migration Tool.

Task 1: Create an Intermediate Template File

Applications generating data in national languages must store that data in AL32UTF8 in the intermediate template file as specified in the IETF RFC 2849, "The LDAP Data Interchange Format (LDIF) - Technical Specification" available at <http://www.ietf.org>.

When generating the intermediate template file, migrating applications must list all user records sequentially with a record separator as defined in RFC 2849. The OID Migration Tool (`ldifmigrator`) assigns all of these users to the default identity management realm, which corresponds to the enterprise itself.

Figure 36–6 shows the overall structure of the intermediate template file containing user entries.

Figure 36–6 Structure of the Intermediate User File

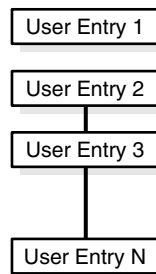

The intermediate template file uses the following format to generate a valid user entry. All of the strings in **bold text** are supplied from the application-specific repository.

```

dn: cn=UserID, %s_UserContainerDN%
sn: Last_Name
orclGlobalID: GUID_for_User
%s_UserNicknameAttribute%: UserID
objectClass: inetOrgPerson
objectClass: orclUserV2
  
```

In this template, the strings **%s_UserContainerDN%** and **%s_UserNicknameAttribute%** are substitution variables for which the OID Migration Tool provides values. The OID Migration Tool determines these values according to deployment-specific considerations. Either the application passes the arguments to the OID Migration Tool, or the tool retrieves them from the directory.

Example: User Entries in an Intermediate Template File The following intermediate template file includes user entries generated by the application-specific migration logic. In this example, all of the data listed in **bold text** is from the application-specific user repository.

```

dn: cn=jdoe, %s_UserContainerDN%
sn: Doe
%s_UserNicknameAttribute%: jdoe
objectClass: inetOrgPerson
objectClass: orclUserV2
title: Member of Technical Staff
homePhone: 415-584-5670
homePostalAddress: 234 Lez Drive$ Redwood City$ CA$ 94402

dn: cn=jsmith, %s_UserContainerDN%
sn: Smith
%s_UserNicknameAttribute%: jsmith
objectClass: inetOrgPerson
objectClass: orclUserV2
title: Member of Technical Staff
homePhone: 650-584-5670
homePostalAddress: 232 Gonzalez Drive$ San Francisco$ CA$ 94404

dn: cn=lrider, %s_UserContainerDN%
sn: Rider
%s_UserNicknameAttribute%: lrider
objectClass: inetOrgPerson
  
```

```
objectClass: orclUserV2
title: Senior Member of Technical Staff
homePhone: 650-584-5670
```

After all of the user data is converted to the intermediate file format, the OID Migration Tool further converts it into a proper LDIF file that can be loaded into Oracle Internet Directory.

You can find examples of intermediate template files in `$ORACLE_HOME/ldap/schema/oid`.

Attributes in User Entries Each user entry has mandatory and optional attributes.

Table 36–2 lists and describes the mandatory attributes in a user entry.

Table 36–2 Mandatory Attributes in a User Entry

Attribute	Description
dn	Distinguished name of the user entry with appropriate substitution variables. The relative distinguished name of the entry MUST contain the cn attribute.
sn	Surname—that is, the last name—of the user
objectclass	Object classes the entry should minimally belong to: <code>inetOrgPerson</code> and <code>orclUserV2</code>

See Also:

- IETF Request for Comments 2798: "Definition of the `inetOrgPerson` LDAP Object Class," available at <http://www.ietf.org>, for a description of each attribute in the `inetOrgPerson` object class
- "Object Class Reference for Oracle Identity Management" in *Oracle Fusion Middleware Reference for Oracle Identity Management* for information about optional attributes of the `orclUserV2` object class

Task 2: Run the OID Migration Tool

After you set up the intermediate template file, the OID Migration Tool enables you to bring all pertinent data from the application-specific repository into Oracle Internet Directory. After you have migrated the data, you can update whatever portion of it is relevant to the application by synchronizing that application with Oracle Internet Directory. You synchronize by using the Oracle Directory Synchronization Service.

See Also: The `ldifmigrator` command-line tool reference in *Oracle Fusion Middleware Reference for Oracle Identity Management* for instructions about using the OID Migration Tool

Configuring Server Chaining

Directory server chaining is a new feature of Oracle Internet Directory, introduced at 10g (10.1.4.0.1). It was implemented using the new Java Plug-in framework.

This chapter contains the following topics:

- [Introduction to Configuring Server Chaining](#)
- [Configuring Server Chaining](#)
- [Creating Server Chaining Configuration Entries](#)
- [Debugging Server Chaining](#)
- [Configuring an Active Directory Plug-in for Password Change Notification](#)

Note: All references to Oracle Single Sign-On in this chapter refer to Oracle Single Sign-On 10g (10.1.4.3.0) or later.

Introduction to Configuring Server Chaining

Server chaining enables you to map entries that reside in third party LDAP directories to part of the directory tree and access them through Oracle Internet Directory, without synchronization or data migration. With server chaining, you can use Oracle Internet Directory's authorization framework when identity data resides outside of Oracle Internet Directory. Server chaining is certified only with Enterprise User Security. No other Oracle applications can be used with server chaining.

Server chaining does not replace Oracle Directory Integration Platform. Rather, it offers complementary functionality to Oracle Directory Integration Platform.

Server chaining is different from a virtual directory. A virtual directory, such as Oracle Virtual Directory, is a flexible virtualization layer between multiple identity repositories and applications. It offers complementary services to identity synchronization and directory servers. With a virtual directory, organizations can create consolidated, logical or virtual views of data that may span multiple directories and databases.

Server chaining is a simpler, more flexible solution, embedded in Oracle Internet Directory server, and particular suited to Enterprise User Security customers. It is easy to administer and upgrade. It also provides Oracle Internet Directory's authorization framework without extra configuration steps.

As of 11g Release 1 (11.1.1), you can configure server chaining to use SSL.

Supported External Servers

Oracle Internet Directory server chaining supports the following external servers:

- Microsoft Active Directory
- Sun Java System Directory Server, formerly known as SunONE iPlanet
- Oracle Directory Server Enterprise Edition
- Novell eDirectory

An implementation of Oracle Internet Directory can connect with one Active Directory server, one Sun Java System Directory Server, one Novell eDirectory, or with all three.

Note: Oracle Internet Directory server chaining does not support Active Directory Lightweight Directory Service (AD LDS), formerly known as ADAM.

Integrated Oracle Products

The following products have been integrated with Oracle Internet Directory server chaining:

- Oracle Single Sign-On 10g (10.1.4.3.0) or later
- Enterprise User Security

Oracle Single Sign-On

When server chaining is enabled, a user from the external directory can log in through Oracle Single Sign-On as if authenticated locally within Oracle Internet Directory, rather than the external repository.

Enterprise User Security

Oracle Internet Directory server chaining enables you to implement Enterprise User Security without synchronizing identity data with Oracle Internet Directory through Oracle Directory Integration Platform. Your identity data remains in the external repository and the Oracle Internet Directory data store contains only Enterprise User Security-related metadata.

With Sun Java System Directory Server as the external directory, server chaining supports password-based authentication with Enterprise User Security. For further details, see Note 802927.1 on My Oracle Support (formerly MetaLink), <http://metalink.oracle.com>.

With Active Directory as the external directory, server chaining supports Kerberos-based authentication and password-based authentication with Enterprise User Security. The external users can log in to Oracle Database after the Enterprise User Security authentication setup is completed. For further details, see "[Configuring an Active Directory Plug-in for Password Change Notification](#)" on page 37-14, which is based on Note 452385.1 on My Oracle Support (formerly MetaLink), <http://metalink.oracle.com>.

See Also: *Oracle Database Enterprise User Security Administrator's Guide* for more information on configuring Enterprise User Security for password authentication and Kerberos authentication.

Supported Operations

Server chaining supports the following operations:

- Bind
- Compare
- Modify
- Search

The compare, modify, and search operations can be enabled or disabled by setting configuration parameters.

When an Oracle Internet Directory client application issues an LDAP search request, Oracle Internet Directory integrates the search results from its own data and the external directories.

When an Oracle Internet Directory client application issues an LDAP bind, compare, or modify request, Oracle Internet Directory redirects the request to the external directory.

In 10g (10.1.4.0.1) and later, the compare operation is only supported for the `userpassword` attribute.

In 10g (10.1.4.0.1) and later, attribute modification is supported in two cases:

- The external attribute has the same name as the Oracle Internet Directory attribute. This is true for most standard LDAP attributes.
- The external attribute is mapped to an Oracle Internet Directory attribute, and neither the external nor the Oracle Internet Directory attribute is an operational attribute.

Note: You cannot modify an Active Directory user password from Oracle Internet Directory through server chaining.

Server Chaining with Replication

If you use server chaining in a replication environment, set it up on all nodes so that the entries remain consistent across nodes. Configure server chaining so that the mapped external directories are the same for all the replicated nodes.

Configuring Server Chaining

Oracle Internet Directory is shipped with disabled sample server chaining entries.

For Active Directory, the DN for the server chaining entry is

```
cn=oidscad,cn=OID Server Chaining,cn=subconfigsubentry
```

For Oracle Directory Server Enterprise Edition and Sun Java System Directory Server, the entry DN is

```
cn=oidsciplanet,cn=OID Server Chaining,cn=subconfigsubentry
```

Novell eDirectory, the entry DN is

```
cn=oidscedir,cn=OID Server Chaining,cn=subconfigsubentry
```

You configure server chaining by customizing these entries for your environment and enabling them. You can do this either from the command line or by using Oracle Directory Services Manager.

This section contains the following topics:

- [Configuring Server Chaining by Using Oracle Directory Services Manager](#)
- [Configuring Server Chaining from the Command Line](#)

Configuring Server Chaining by Using Oracle Directory Services Manager

Oracle Directory Services Manager provides a convenient interface for modifying the Oracle Internet Directory server chaining configuration entries. To configure server chaining by using Oracle Directory Services Manager, perform the following steps:

1. Invoke Oracle Directory Services Manager and connect to the Oracle Internet Directory server as described in "[Invoking Oracle Directory Services Manager](#)" on page 7-9.
2. From the task selection bar, select **Advanced**.
3. Expand **Server Chaining**. Server Chaining entries appear in the left panel. Current entries include iPlanet (Oracle Directory Server Enterprise Edition and Sun Java System Directory Server) and Active Directory.
4. To modify a server chaining configuration entry, select it. The Server Chaining Management tab appears in the right pane.
5. Modify **External Host Name**, **External Port Number**, **Login User DN**, and **Login User Password** as necessary.
6. To enable server chaining authentication, modification, or search, select the corresponding checkbox.
7. Modify the other fields as necessary.
8. After modifying an external user container, group container, or login credential, verify the value by clicking **Verify User Container**, **Verify Group Container**, or **Verify Login Credential**, respectively.

If the verification fails, examine the values you entered for errors. If the problem persists, consult the external directory administrator to verify the accuracy of the values you entered.

9. If you want to add an attribute mapping, click the **Add attribute mappings to list** icon under Attribute Mapping. To edit an existing mapping, select the mapping and click the **Edit Attribute Mapping** icon under Attribute Mapping. The New Attribute Mapping window appears. Enter the External Directory Attribute and the OID Attribute. To locate Oracle Internet Directory attribute by browsing, click **Select** then select the attribute in the Attribute Selection window.
10. Click **OK** to create the mapping or click **Cancel** to abandon it.
11. To delete a mapping, select the mapping and click the **Delete selected attribute mapping** icon. When the Delete Confirm dialog appears, click **Delete** to delete the mapping or **Cancel** to abandon deletion.
12. Click **OK** to enable the configuration changes or click **Cancel** to abandon the changes.

Configuring Server Chaining from the Command Line

Perform the following steps to configure server chaining from the command line:

1. Create an LDIF file to manually add the user and group containers. To determine the DNs for these containers, see the section [Requirements for User and Group Containers](#) on page 37-8. For example, if your user search base is `cn=users,dc=us,dc=oracle,dc=com`, and the group search base is `cn=groups,dc=us,dc=oracle,dc=com`, then you would use the following entries in your LDIF file:

```
dn: cn=AD,cn=users,dc=us,dc=oracle,dc=com
cn: AD
objectclass: orclcontainer
objectclass: top
```

```
dn: cn=iPlanet,cn=users,dc=us,dc=oracle,dc=com
cn: iPlanet
objectclass: orclcontainer
objectclass: top
```

```
dn: cn=AD,cn=groups,dc=us,dc=oracle,dc=com
cn: AD
objectclass: orclcontainer
objectclass: top
```

```
dn: cn=iPlanet,cn=groups,dc=us,dc=oracle,dc=com
cn: iPlanet
objectclass: orclcontainer
objectclass: top
```

2. Use `ldapadd` and the LDIF file you just created to add the entries.

```
ldapadd -p port -h host -D "binddn" -q -v -f container_ldif_file_name
```

3. Create another LDIF file to modify and enable the server chaining configuration entries. For example LDIF files, see ["Active Directory Example"](#) on page 37-9 and ["Oracle Directory Server Enterprise Edition and Sun Java System Directory Server \(iPlanet\) Example"](#) on page 37-11. A table of attributes is provided in ["Creating Server Chaining Configuration Entries"](#) on page 37-5. Attribute mapping is explained in [Attribute Mapping](#) on page 37-8.

4. Modify the server chaining configuration entries using the `ldapmodify` command and the LDIF file you just created. Use a command line of the form:

```
ldapmodify -D "cn=orcladmin" -q -p port -h host -D "binddn" \
-v -f entry_ldif_file_name
```

Creating Server Chaining Configuration Entries

This section contains the following topics:

- [Configuration Entry Attributes](#)
- [Requirements for User and Group Containers](#)
- [Attribute Mapping](#)
- [Active Directory Example](#)
- [Active Directory with SSL Example](#)

- [Oracle Directory Server Enterprise Edition and Sun Java System Directory Server \(iPlanet\) Example](#)
- [Oracle Directory Server Enterprise Edition and Sun Java System Directory Server \(iPlanet\) with SSL Example](#)
- [eDirectory Example](#)
- [eDirectory with SSL Example](#)

Configuration Entry Attributes

Table 37-1 lists the configuration entry attributes for server chaining.

Table 37-1 Configuration Entry Attributes for Server Chaining

Attribute	Required	Description
orclOIDSExtHost	Yes	The host name of the external directory host. This is a single value attribute.
orclOIDSExtPort	Yes	The port number of the external directory host. This is a single value attribute. The default value is 3060.
orclOIDSExtDN	Yes	The DN in the external directory. Server chaining binds against the external directory using this identity to perform search and modify operations. This identity must have sufficient privilege to perform the operation. This is a single value attribute.
orclOIDSExtPassword	Yes	The password for the DN of the external directory. This is a single value attribute. Be sure to enable privacy mode to ensure that users cannot retrieve this attribute in clear text. See "Configuring Privacy of Retrieved Sensitive Attributes" on page 27-7.
orclOIDSExtUserContainer	Yes	The user container in the external directory from which to perform the user search operation. This is a single value attribute.
orclOIDSExtGroupContainer	Yes	The group container in the external directory from which to perform the group search operation. This is a single value attribute. This attribute is optional if the external user container and the external group container are the same. In this case the group search operations are performed on the external user container.
orclOIDSCTargetUserContainer	Yes	The user container in Oracle Internet Directory in which the external users reside. For more information, see "Requirements for User and Group Containers" on page 37-8.
orclOIDSCTargetGroupContainer	Yes	The group container in Oracle Internet Directory in which the external groups reside. For more information, see "Requirements for User and Group Containers" on page 37-8.

Table 37-1 (Cont.) Configuration Entry Attributes for Server Chaining

Attribute	Required	Description
orclOIDSCAttrMapping	No	Specifies each attribute mapping between the external directory and Oracle Internet Directory. For example, to map the eMail attribute from Active Directory to the mail attribute in Oracle Internet Directory, set this attribute to: orclOIDSCAttrMapping;mail:eMail For more information, see " Attribute Mapping " on page 37-8
orclOIDSCExtSearchEnabled	Yes	External search capability. 0 = disabled (default), 1 = enabled. This is a single value attribute.
orclOIDSCExtModifyEnabled	Yes	External modify capability. 0 = disabled (default), 1 = enabled. This is a single value attribute.
orclOIDSCExtAuthEnabled	Yes	External authentication capability. 0 = disabled (default), 1 = enabled. This is a single value attribute.
orclOIDSCSSLEnabled	No	SSL connection to the external directory. 0 = disabled (default), 1 = enabled. This is a single value attribute. Required if SSL is enabled.
orclOIDSCExtSSLPort	No	The SSL port number of the external directory host. This is a single value attribute.
OrclOIDSCWalletLocation	No	The filename and path of the wallet that contains the server certificate of the external directory. This is a single value attribute. Required if SSL is enabled
orclOIDSCWalletPassword	No	The wallet password. This is a single value attribute. Required if SSL is enabled
mapUIDtoADAttribute	No	Specifies the mapping of OID attribute "uid" to an attribute in Active Directory. You can map "uid" to any non-binary attributes defined in Active Directory. The default value is "name". This is a single value attribute.
showExternalGroupEntries	No	In a search against the group container: "base" - show entries with objectclass group (default), "sub" - show entries without objectclass "user" and "computer". This is a single value attribute. Applicable with Active Directory only.
showExternalUserEntries	No	In a one level search with an entry one level below the user container as the base: "base" - do not show any entry (default), "sub" - show entries in the subtree below the base of the search. This is a single value attribute. Applicable with Active Directory only.
addOrcluser2ToADUsers	No	Add "orcluser2" objectclass to entries that have objectclass user. 0 = disabled (default), 1 = enabled. This is a single value attribute. Applicable with Active Directory only.

Requirements for User and Group Containers

The target user and group containers must be under the Oracle Internet Directory search base in order to work with Oracle Single Sign-On. Use the container names `cn=AD` for Active Directory and `cn=iPlanet` for Oracle Directory Server Enterprise Edition or Sun Java System Directory Server (iPlanet). For example, if your user search base is:

```
cn=users,dc=us,dc=oracle,dc=com
```

you would use

```
cn=AD,cn=users,dc=us,dc=oracle,dc=com
```

as the target user container for the Active Directory users or

```
cn=iPlanet,cn=users,dc=us,dc=oracle,dc=com
```

as the target user container for the Sun Java System Directory Server users. Similarly, if your group search base is:

```
cn=groups,dc=us,dc=oracle,dc=com
```

you would use

```
cn=AD,cn=groups,dc=us,dc=oracle,dc=com
```

as the target container for the Active Directory s or

```
cn=iPlanet,cn=groups,dc=us,dc=oracle,dc=com
```

as the target container for the Oracle Directory Server Enterprise Edition or Sun Java System Directory Server groups.

The target user and group containers exist only for the external directories. All the users and groups that appear under these nodes are populated by the external directories. Do not add entries under these containers directly from Oracle Internet Directory.

Attribute Mapping

If an attribute in an external directory and an Oracle Internet Directory attribute are the same, then no mapping is required. Server chaining performs some attribute mapping by default. The default mapping list is as follows:

Table 37-2 Default Attribute Mapping to Active Directory

Oracle Internet Directory Attribute	Active Directory Attribute
orclguid	objectGUID
uid	name
orclsamaccountname	samaccountname
krbprincipalname	userprincipalname

For Active Directory server chaining, you can use the `mapUIDtoADAttribute` attribute to map `uid` to any non-binary attributes defined in Active Directory.

Table 37-3 Default Attribute Mapping to Sun Java System Directory Server

Oracle Internet Directory Attribute	Sun Java System Directory Server Attribute
orclguid	nsuniqueid
authpassword	userpassword
krbprincipalname	mail

Table 37-4 Default Attribute Mapping to Novell eDirectory

Oracle Internet Directory Attribute	Novell eDirectory Attribute
orclguid	guid
orclsamaccountname	uid
krbprincipalname	mail

The following objects cannot be mapped:

- Operational attributes
- Object classes
- Oracle Internet Directory- specific attributes. These attributes typically have names starting with `orcl`.

Active Directory Example

The following example shows server chaining configured to use the Active Directory server `dlin-pc9.us.example.com`, port 3060, as its external directory store. The SSL capability has been enabled. All the attributes are explained in [Table 37-1](#) on page 37-6.

```
cn=oidscad,cn=OID Server Chaining,cn= subconfigsubentry
orclOIDSCEstHost: dlin-pc9.us.example.com
orclOIDSCEstPort: 3060
orclOIDSCEstDN: cn=administrator,cn=users,dc=oidvd,dc=com
orclOIDSCEstPassword: *****
orclOIDSCEstUserContainer: cn=users,dc=oidvd,dc=com
orclOIDSCTargetUserContainer: cn=AD,cn=users,dc=us,dc=oracle,dc=com
orclOIDSCTargetGroupContainer: cn=AD,cn=groups,dc=us,dc=oracle,dc=com
orclOIDSCEstSearchEnabled: 1
orclOIDSCEstModifyEnabled: 1
orclOIDSCEstAuthEnabled: 1
orclOIDSCEstAttrMapping;description: title
orclOIDSCEstSSLenabled: 0
```

The following example is the LDIF file used to modify the configuration entry:

```
dn: cn=oidscad,cn=oid server chaining,cn=subconfigsubentry
changetype: modify
replace: orclOIDSCEstDN
orclOIDSCEstDN: cn=administrator,cn=users,dc=oidvd,dc=com
-
replace: orclOIDSCEstPassword
orclOIDSCEstPassword: password
-
replace: orclOIDSCEstHost
```

```

orcloidscecthost: dlin-pc9.us.example.com
-
replace: orcloidscectport
orcloidscectport: 3060
-
replace: orcloidsctargetusercontainer
orcloidsctargetusercontainer: cn=AD,cn=users,dc=us,dc=oracle,dc=com
-
replace: orcloidsctargetgroupcontainer
orcloidsctargetgroupcontainer: cn=AD,cn=groups,dc=us,dc=oracle,dc=com
-
replace: orcloidscectusercontainer
orcloidscectusercontainer: cn=users,dc=dlin,dc=net
-
replace: orcloidscectgroupcontainer
orcloidscectgroupcontainer: cn=users,dc=dlin,dc=net
-
replace: orcloidscectsearchenabled
orcloidscectsearchenabled: 1
-
replace: orcloidscectmodifyenabled
orcloidscectmodifyenabled: 1
-
replace: orcloidscectauthenabled
orcloidscectauthenabled: 1
-
replace: orcloidscsslenabled
orcloidscsslenabled:1

```

Active Directory with SSL Example

The following example shows server chaining configured to use the Active Directory server `ad.example.com`, SSL port 3133, and the wallet located at `/adwallet/ewallet.p12`.

```

cn=oidscad,cn=OID Server Chaining,cn= subconfigsubentry
orcloIDSCEctHost: ad.example.com
orcloIDSCEctPort: 3060
orcloIDSCEctDN: cn=administrator,cn=users,dc=oidvd,dc=com
orcloIDSCEctPassword: *****
orcloIDSCEctUserContainer: cn=users,dc=oidvd,dc=com
orcloIDSCTargetUserContainer: cn=AD,cn=users,dc=oracle,dc=com
orcloIDSCTargetGroupContainer: cn=AD,cn=groups,dc=oracle,dc=com
orcloIDSCEctSearchEnabled: 1
orcloIDSCEctModifyEnabled: 1
orcloIDSCEctAuthEnabled: 1
orcloIDSCESSLEnabled: 1
orcloIDSCEctSSLPort: 3133
orcloIDSCWalletLocation: /adwallet/ewallet.p12
orcloIDSCWalletPassword: *****

```

Perform the following steps to configure server chaining with SSL from the command line:

1. Configure Active Directory server chaining without SSL, as described in the previous section.
2. Create an LDIF file like the following to enable SSL connection to the external directory. Replace the values of `orcloidscectsslport`,

orcl0idscwalletlocation and orcl0idscwalletpassword with values that match the actual Active Directory server:

```
dn: cn=oidscad,cn=oid server chaining,cn=subconfigsubentry
changetype: modify
replace: orcl0idscsslenabled
orcl0idscsslenabled:1
-
replace: orcl0idscextsslport
orcl0idscextsslport: 3133
-
replace: orcl0idscwalletlocation
orcl0idscwalletlocation: /adwallet/ewallet.p12
-
replace: orcl0idscwalletpassword
orcl0idscwalletpassword: passw0rd
```

3. To apply the changes, use a command line such as

```
ldapmodify -p OID_port -h OID_host -D "cn=orcladmin" -q -v -f ldif_file_name
```

Active Directory with New Attributes Example

The attributes `mapUIDtoADAttribute`, `showExternalGroupEntries`, `showExternalUserEntries`, and `addOrcluserV2ToADUsers` have been added since Oracle Internet Directory 10g (10.1.4.0.1). To add these attributes to an existing Active Directory server chaining entry, modify the following LDIF file with the appropriate values:

```
dn: cn=oidscad,cn=oid server chaining,cn=subconfigsubentry
changetype: modify
replace: mapUIDtoADAttribute
mapUIDtoADAttribute: name
-
replace: showExternalGroupEntries
showExternalGroupEntries: base
-
replace: showExternalUserEntries
showExternalUserEntries: base
-
replace: addOrcluserV2ToADUsers
addOrcluserV2ToADUsers: 0
```

Use a command line such as

```
ldapmodify -p OID_port -h OID_host -D "cn=orcladmin" -q -v -f ldif_file_name
```

to modify the configuration entry.

Oracle Directory Server Enterprise Edition and Sun Java System Directory Server (iPlanet) Example

The following example shows server chaining configured to use the Sun Java System Directory Server `dlin-pc10.us.example.com`, port 103060, as its external directory store. All the attributes are explained in [Table 37-1](#) on page 37-6.

```
cn=oidsciplanet,cn=OID Server Chaining,cn=subconfigsubentry
orcl0IDSCExtHost: dlin-pc10.us.example.com
orcl0IDSCExtPort: 10389
orcl0IDSCExtDN: cn=directory manager
```

```

orclOIDSCExtPassword: *****
orclOIDSCExtUserContainer: ou=people,dc=example,dc=com
orclOIDSCExtGroupContainer: ou=groups,dc=example,dc=com
orclOIDSCTargetUserContainer: cn=iPlanet,cn=users,dc=us,dc=oracle,dc=com
orclOIDSCTargetGroupContainer: cn=iPlanet,cn=groups,dc=us,dc=oracle,dc=com
orclOIDSCExtSearchEnabled: 1
orclOIDSCExtModifyEnabled: 1
orclOIDSCExtAuthEnabled: 1
orclOIDSCESSLEnabled:0

```

The following example is the LDIF file used to modify the configuration entry:

```

dn: cn=oidsciplanet,cn=oid server chaining,cn=subconfigsubentry
changetype: modify
replace: orcloidscestdn
orcloidscestdn: cn=directory manager
-
replace: orcloidscestdnpassword
orcloidscestdnpassword: password
-
replace: orcloidscestdnhost
orcloidscestdnhost: dlin-pc10.us.example.com
-
replace: orcloidscestdnport
orcloidscestdnport: 10389
-
replace: orcloidsctargetusercontainer
orcloidsctargetusercontainer: cn=iplanet,cn=users,dc=us,dc=oracle,dc=com
-
replace: orcloidsctargetgroupcontainer
orcloidsctargetgroupcontainer: cn=iplanet,cn=groups,dc=us,dc=oracle,dc=com
-
replace: orcloidscestdnusercontainer
orcloidscestdnusercontainer: ou=people,dc=example,dc=com
-
replace: orcloidscestdngroupcontainer
orcloidscestdngroupcontainer: ou=groups,dc=example,dc=com
-
replace: orcloidscestdnsearchenabled
orcloidscestdnsearchenabled: 1
-
replace: orcloidscestdnmodifyenabled
orcloidscestdnmodifyenabled: 1
-
replace: orcloidscestdnauthenabled
orcloidscestdnauthenabled: 1

```

Oracle Directory Server Enterprise Edition and Sun Java System Directory Server (iPlanet) with SSL Example

The following example shows server chaining configured to use the Sun Java System Directory Server sunone.example.com, SSL port 10636, and the wallet located at /ipwallet/ewallet.p12

```

cn=oidsciplanet,cn=OID Server Chaining,cn=subconfigsubentry
orclOIDSCExtHost: sunone.example.com
orclOIDSCExtPort: 10389
orclOIDSCExtDN: cn=directory manager
orclOIDSCExtPassword: *****
orclOIDSCExtUserContainer: ou=people,dc=example,dc=com

```

```

orcl0IDSCExtGroupContainer: ou=groups,dc=example,dc=com
orcl0IDSCTargetUserContainer: cn=iPlanet,cn=users,dc=oracle,dc=com
orcl0IDSCTargetGroupContainer: cn=iPlanet,cn=groups,dc=oracle,dc=com
orcl0IDSCExtSearchEnabled: 1
orcl0IDSCExtModifyEnabled: 1
orcl0IDSCExtAuthEnabled: 1
orcl0IDSCSSLEnabled: 1
orcl0IDSCExtSSLPort: 10636
orcl0IDSCWalletLocation: /ipwallet/ewallet.p12
orcl0IDSCWalletPassword: *****

```

Perform the following steps to configure server chaining with SSL from the command line:

1. Configure server chaining without SSL, as described in the previous section.
2. Create the following LDIF file to enable SSL connection to the external directory. Replace the values of `orcl0idsceextsslport`, `orcl0idscwalletlocation` and `orcl0idscwalletpassword` with values that match the actual Oracle Directory Server Enterprise Edition/Sun Java System Directory Server.

```

dn: cn=oidsciplanet,cn=oid server chaining,cn=subconfigsubentry
changetype: modify
replace: orcl0idscsslenabled
orcl0idscsslenabled:1
-
replace: orcl0idsceextsslport
orcl0idsceextsslport: 10636
-
replace: orcl0idscwalletlocation
orcl0idscwalletlocation: /ipwallet/ewallet.p12
-
replace: orcl0idscwalletpassword
orcl0idscwalletpassword: passw0rd

```

3. Execute a command such as

```
ldapmodify -p OID_port -h OID_host -D "cn=orcladmin" -q -v -f ldif_file_name
```

to modify the configuration entry.

eDirectory Example

A sample eDirectory configuration looks like this:

```

cn=oidscedir,cn=OID Server Chaining,cn=subconfigsubentry
orcl0IDSCExtHost: edirhost.domain.com
orcl0IDSCExtPort: 3060
orcl0IDSCExtDN: cn=admin,o=domain
orcl0IDSCExtPassword: *****
orcl0IDSCExtUserContainer: ou=users,o=domain
orcl0IDSCExtGroupContainer: ou=groups,o=domain
orcl0IDSCTargetUserContainer: cn=edir,cn=users,dc=us,dc=oracle,dc=com
orcl0IDSCTargetGroupContainer: cn=edir,cn=groups,dc=us,dc=oracle,dc=com
orcl0IDSCExtSearchEnabled: 1
orcl0IDSCExtModifyEnabled: 1
orcl0IDSCExtAuthEnabled: 1
orcl0IDSCSSLEnabled:0

```

eDirectory with SSL Example

A sample edirectory configuration with SSL looks like this:

```
cn=oidscedir,cn=OID Server Chaining,cn=subconfigsubentry
orclOIDSCExtHost: edirhost.domain.com
orclOIDSCExtPort: 3060
orclOIDSCExtDN: cn=admin,o=domain
orclOIDSCExtPassword: *****
orclOIDSCExtUserContainer: ou=users,o=domain
orclOIDSCExtGroupContainer: ou=groups,o=domain
orclOIDSCTargetUserContainer: cn=edir,cn=users,dc=us,dc=oracle,dc=com
orclOIDSCTargetGroupContainer: cn=edir,cn=groups,dc=us,dc=oracle,dc=com
orclOIDSCExtSearchEnabled: 1
orclOIDSCExtModifyEnabled: 1
orclOIDSCExtAuthEnabled: 1
orclOIDSCSSLEnabled: 1
orclOIDSCExtSSLPort: 3133
orclOIDSCWalletLocation: /edir/ewallet.p12
orclOIDSCWalletPassword: *****
```

Debugging Server Chaining

To debug server chaining, perform the following steps:

1. Set the Oracle Internet Directory server debug logging level, as described in ["Managing Logging by Using Fusion Middleware Control"](#) on page 4 or ["Managing Logging from the Command Line"](#) on page 6. Use the logging level value 402653184. This value enables logging of all messages related to the Java plug-in framework.
2. Modify the Oracle Internet Directory server chaining debugging settings. For both `cn=oidscad,cn=oid server chaining,cn=subconfigsubentry` and `cn=oidsciplanet,cn=oid server chaining, cn=subconfigsubentry`, set the attribute `orcloidscDebugEnabled` to 1.

For example, to set `orcloidscDebugEnabled` to 1 in `cn=oidscad,cn=oid server chaining,cn=subconfigsubentry`, you would type:

```
$ORACLE_HOME/bin/ldapmodify -h host -p port -D cn=orcladmin -q -f file
```

where *file* contains:

```
dn: cn=oidscad,cn=oid server chaining,cn=subconfigsubentry
changetype: modify
replace: orcloidscDebugEnabled
orcloidscDebugEnabled: 1
```

See Also: The Java Plug-in Debugging and Logging section in *Oracle Fusion Middleware Application Developer's Guide for Oracle Identity Management*.

Configuring an Active Directory Plug-in for Password Change Notification

When you use Enterprise User Security (EUS) with Server Chaining, a hash password is required in order to authenticate users. This section describes how to install a plug-in in the Microsoft Active Directory (AD) server so that this hash password is available to users accessed through Oracle Internet Directory. Customers planning to

configure Enterprise User Security (EUS) to work with users accessed through Server Chaining must configure this feature.

The steps are as follows

1. In Active Directory, create an attribute called `orclCommonAttribute` to store the hash password. Use a command line such as:

```
ldapadd -p AD_Port -h AD_host -D "AD_administrator_DN" -w AD_administrator_
password -v -f orclca.ldif
```

Use an `orclca.ldif` file similar to the following example. Replace `DC=bill,DC=com` with the actual Active Directory domain name and choose an appropriate `attributeID`.

```
dn: cn=orclcommonattribute,CN=Schema,CN=Configuration,DC=bill,DC=com
objectClass: top
objectClass: attributeSchema
cn: orclcommonattribute
distinguishedName:
CN=orclcommonattribute,CN=Schema,CN=Configuration,DC=bill,DC=com
instanceType: 4
uSNCreated: 16632
attributeID: 1.9.9.9.9.9.9.9.9
attributeSyntax: 2.5.5.3
isSingleValued: TRUE
uSNChanged: 16632
showInAdvancedViewOnly: TRUE
adminDisplayName: orclCommonAttribute
oMSyntax: 27
LDAPDisplayName: orclCommonAttribute
name: orclcommonattribute
objectCategory: CN=Attribute-Schema,CN=Schema,CN=Configuration,DC=bill,DC=com
```

2. Associate the attribute with the user objectclass. Use a command line such as:

```
ldapadd -p AD_Port -h AD_host -D "AD_administrator_DN" -w AD_administrator_
password -v -f user.ldif
```

In the following file, `user.ldif`, replace `DC=bill,DC=com` with the actual Active Directory domain name.

```
dn: CN=User,CN=Schema,CN=Configuration,DC=bill,DC=com
changetype: modify
add: mayContain
mayContain: orclCommonAttribute
```

It might take Active Directory a few minutes to refresh the schema.

3. Install the password change notification plug-in, as follows:
 - a. Copy `%ORACLE_HOME%\ldap\admin\oidpwdcn.dll` to the Active Directory `WINDOWS\system32` folder.
 - b. Use `regedt32` to modify the registry. In the line: `HKEY_LOCAL_MACHINE\SYSTEM\CurrentControlSet\Control\Lsa\Notification Packages`, add `oidpwdcn` to the end. It should look like the following:

```
RASSFM
KDCSVC
WDIGEST
scecli
oidpwdcn
```

- c. Restart Active Directory.
 - d. Verify that the plug-in is installed properly by resetting the password of a user. The `orclCommonAttribute` should contain the hash password value.
4. Reset the password for all the Active Directory users so that the password verifier is present for all the users.

Part V

Advanced Administration: Directory Replication

This part provides detailed discussions of replication and high availability and how to plan and manage them. It contains these chapters:

- [Chapter 38, "Setting Up Replication"](#)
- [Chapter 39, "Setting Up Replication Failover"](#)
- [Chapter 40, "Managing Replication Configuration Attributes"](#)
- [Chapter 41, "Managing and Monitoring Replication"](#)

Setting Up Replication

Replication is the process of copying and maintaining the same naming contexts on multiple directory servers. It can improve performance by providing more servers to handle queries and by bringing the data closer to the client. It improves reliability by eliminating risks associated with a single point of failure.

Before reading this chapter, please see [Chapter 6, "Understanding Oracle Internet Directory Replication"](#) for an introduction to basic replication concepts.

This chapter presents some information that is common to both Advance Replication-based replication and LDAP-based replication. The procedural sections of the chapter describe how to set up LDAP-based replication and multimaster replication with fan-out. For information and procedures specific to Oracle Database Advanced Replication-based replication, please see [Appendix C, "Setting Up Oracle Database Advanced Replication-Based Replication."](#)

See Also: ["Transport Mechanism: LDAP or Oracle Database Advanced Replication"](#) on page 6-4.

See Also: *Oracle Fusion Middleware High Availability Guide* for information on setting up replication in high availability configurations.

This chapter contains the following topics:

- [Introduction to Setting Up Replication](#)
- [Converting an Advanced Replication-Based Agreement to an LDAP-Based Agreement](#)
- [Setting Up an LDAP-Based Replication Agreement by Using the Replication Wizard](#)
- [Testing Replication by Using Oracle Directory Services Manager](#)
- [Setting Up an LDAP-Based Replication by Using the Command Line](#)
- [Setting Up a Multimaster Replication Group with Fan-Out](#)

Note: All references to Oracle Single Sign-On or Oracle Delegated Administration Services in this chapter refer to Oracle Single Sign-On 10g (10.1.4.3.0) or later and Oracle Delegated Administration Services 10g (10.1.4.3.0) or later.

Introduction to Setting Up Replication

If you are unfamiliar with basic replication concepts, please see [Chapter 6, "Understanding Oracle Internet Directory Replication"](#) before reading this introduction.

This introduction contains the following topics:

- [Replication Transport Mechanisms](#)
- [Replication Setup Methods](#)
- [Bootstrap Rules](#)
- [The Replication Agreement](#)
- [Other Replication Configuration Attributes](#)
- [Replication Process and Architecture](#)
- [Rules for Configuring LDAP-Based Replication](#)
- [Replication Security](#)
- [LDAP Replication Filtering for Partial Replication](#)

Replication Transport Mechanisms

Oracle Internet Directory supports two replication transport mechanisms.

- LDAP-based replication uses the industry-standard Lightweight Directory Access Protocol Version 3. You can set up LDAP-based replication in one-way, two-way, and multimaster configurations. This is the recommended protocol for most environments.
- Oracle Database Advanced Replication-based replication uses the replication capability of Oracle Database. Only multimaster configurations are supported. (You can create a single master DRG by switching all nodes in a group but one to read-only mode.)

If you must replicate Oracle Single Sign-On data, you must use Oracle Database Advanced Replication-based replication. For information and procedures specific to Advanced Replication-based replication, please see [Appendix C, "Setting Up Oracle Database Advanced Replication-Based Replication."](#)

You can convert an existing Oracle Database Advanced Replication-based multimaster agreement to an LDAP-based multimaster agreement. by using `remtool -asr2ldap`. See "[Converting an Advanced Replication-Based Agreement to an LDAP-Based Agreement](#)" on page 38-15.

See Also: The `remtool` command-line tool reference in *Oracle Fusion Middleware Reference for Oracle Identity Management* for more information about the Replication Environment Management Tool

Replication Setup Methods

The following methods are available for setting up Oracle Internet Directory replication.

Replication Wizard

The recommended method for setting up LDAP-based replication is to use the replication wizard in Oracle Enterprise Manager Fusion Middleware Control. The

procedure is described in ["Setting Up an LDAP-Based Replication Agreement by Using the Replication Wizard"](#) on page 38-16. You can also use the wizard for modifying an existing replication agreement, as described in ["Viewing or Modifying a Replication Setup by Using the Replication Wizard"](#) on page 41-9 and ["Deleting an LDAP-Based Replication Agreement by Using the Replication Wizard"](#) on page 41-10.

Command Line Tools

You must use command line tools to set up Advanced Replication-based replication. You can also use command line tools to set up LDAP-based replication.

Command-line setup of LDAP-based replication is described in ["Setting Up an LDAP-Based Replication by Using the Command Line"](#) on page 38-17. Command-line setup of Advanced Replication-based replication is described in [Appendix C, "Setting Up Oracle Database Advanced Replication-Based Replication."](#)

When setting up replication from the command line, you use the `oidctl` command for stopping and starting the replication server. You use bulk tools for backing up data and loading it to other nodes. You use LDAP tools for a few operations.

Optionally, you can use the bootstrap capability of the replication server for the initial data migration.

You use the Replication Environment Management Tool, `remtool`, to perform various replication-related tasks, including:

- Setting up a replication group
- Converting an existing Oracle Database Advanced Replication-based agreement to an LDAP multimaster agreement.
- Adding and deleting replicas
- Managing the directory replication group
- Modifying or resetting the replication Bind DN password
- Modifying the database replication user REPADMIN password
- Displaying various errors and status information for change log propagation

See Also: The `remtool` command-line tool reference in *Oracle Fusion Middleware Reference for Oracle Identity Management* for more information about the Replication Environment Management Tool

Database Copy Procedure

It is possible to set up replication on a new host by copying the Oracle Database from an existing host. This is a complex procedure that is not recommended for most environments. The procedure is described in [Appendix L, "Adding a Directory Node by Using the Database Copy Procedure."](#)

Bootstrap Rules

Whether you are using the replication wizard in Fusion Middleware Control or the command line, you can use the bootstrap capability of the replication server for the initial data migration.

You set the bootstrap flag by setting the attribute `orclreplicastate` to 0 under the `replicadn`.

See Also:

- ["Setting Up an LDAP-Based Replica by Using Automatic Bootstrapping"](#) on page 38-19
- ["LDAP Replica States"](#) on page D-5

When a replica is in bootstrap mode, the supplier node must be in on line mode (`orclreplicastate=1`). Do not set the supplier and consumer to bootstrap at same time.

Bootstrap cannot be used for initial data migration on a node that has more than one supplier. Therefore, bootstrap is limited to the following types of replica:

- A leaf replica, that is, one that has no consumer replicas.
- A primary replica in a two-node LDAP-based multi-master replication agreement, provided it has no two-way fanout replicas.
- A non-primary replica in an LDAP-based multimaster replication agreement with two or more nodes, provided it has no two-way fanout replicas.
- A fanout replica with only one supplier

If you set the bootstrap flag (`orclreplicastate=0` under `replicadn`) of any other replica, the replication server throws one of these messages:

```
bootstrapping against non-leaf replica is not allowed
bootstrap against master replica is not allowed
```

Notes:

- Bootstrap is not allowed for Oracle Database Advanced Replication replicas.
 - Disable referential integrity during the replication bootstrapping process. If referential integrity is enabled, bootstrapping fails.
-
-

The Replication Agreement

When you set up replication, you create a container called a replication agreement in the DIT on each of the participating hosts. The attributes of the replication agreement entry are described in ["The Replication Agreement Entry"](#) on page 40-3.

If you use the replication wizard in Oracle Enterprise Manager Fusion Middleware Control, your selections on the Settings page of the wizard specify the replication agreement attributes that control connection and scheduling.

Your choices on that page include:

- Whether the replication server should use same connection for performing multiple LDAP operations (Keep Alive) or open a new connection for each LDAP operation (Always Use New Connection).
- The frequency at which replication should occur (Replication Frequency).
- The interval at which the replication server should repeat the change application process (Human Intervention Queue Schedule). See ["How the Multimaster Replication Process Adds a New Entry to a Consumer"](#) on page D-8 for more information about the change application process and the human intervention queue.

The replication agreement also contains the replication contexts. These are discussed in more detail in ["LDAP Replication Filtering for Partial Replication"](#) on page 38-7. The attributes are described in ["The Replication Agreement Entry"](#) on page 40-3.

Other Replication Configuration Attributes

In addition to the replication agreement entry, the DIT includes several other entries that contain attributes that control replication. The entries and their attributes are described in [Chapter 40, "Managing Replication Configuration Attributes."](#) Once you have set up replication, you can manage these attributes.

Oracle Enterprise Manager Fusion Middleware Control has a Replication page, separate from the replication wizard, that enables you to configure replication attributes. You can also modify replication attributes by using LDAP tools. These methods are described in [Chapter 41, "Managing and Monitoring Replication."](#)

Replication Process and Architecture

See [Chapter D, "How Replication Works"](#) for detailed information about replication architecture and the replication process.

Rules for Configuring LDAP-Based Replication

The following rules apply to LDAP-based replication:

1. If you have multiple Oracle Internet Directory instances that use the same Oracle Database, only one of the instances can be set up for replication.
2. LDAP Multimaster replication is not backward compatible. It is only supported between replicas that are running 11g Release 1 (11.1.1).
3. For either multimaster replication or two-way fan-out replication, all nodes must be running the same release of Oracle Internet Directory. Therefore, you must turn off replication while performing rolling upgrades.
4. You can add a one-way fan-out replica that is running a newer release than its supplier. For example, in [Figure 6-5, "Example of Fan-Out Replication"](#), Node F can be running a newer release than the other nodes.
5. In general, do not replicate changes generated on a newer version of Oracle Internet Directory to a node that has not yet upgraded to that version. If you do, the changes can contain information that the earlier version cannot properly interpret.
6. More specifically, if you add a new Oracle Internet Directory 11g Release 1 (11.1.1.2) node to an existing DRG as a one-way fan-out replica, there is no need to upgrade other nodes of DRG. For all other types of replication, first upgrade the nodes in the DRG before adding the new node. This is true whether the existing nodes are running a 10g release or 11g Release 1 (11.1.1.1). For example, in [Figure 6-5, "Example of Fan-Out Replication"](#), before adding an Oracle Internet Directory 11g Release 1 (11.1.1.2) node as Node E, you must first update Nodes A, B, C and G to 11g Release 1 (11.1.1.2).
7. In LDAP-based replication, only the naming contexts listed in the `namingcontexts` attribute of the root DSE can be replicated to the consumer.

See Also: The discussion of naming contexts in:

- ["Included and Excluded Naming Contexts in LDAP Replication Filtering"](#) on page 38-7
- ["Modifying What Is to Be Replicated in LDAP-Based Partial Replication"](#) on page 41-2

8. The supplier of an LDAP-based replica can be a master node that is not a member of any replication group, a member of a multimaster replication group, or another LDAP-based replica.

See Also: *Oracle Fusion Middleware Installation Guide for Oracle Identity Management* for instructions on installing Oracle Internet Directory.

9. An LDAP-based replica can be a consumer for another LDAP-based replica. That consumer is then called a fan-out replica.

Note: Make sure the schemas are synchronized. Otherwise, the replication server might not be able to apply changes to the consumer replica.

10. The new consumer node must be empty. That is, Oracle Internet Directory must be newly installed.

Replication Security

This section contains these topics:

- [Authentication and the Directory Replication Server](#)
- [Secure Sockets Layer \(SSL\) and Oracle Internet Directory Replication](#)

Authentication and the Directory Replication Server

Authentication is the process by which the Oracle directory replication server establishes the true identity of itself when connecting to the directory server. It occurs when an LDAP session is established by means of an ldapbind operation.

It is important that the directory replication server be properly authenticated before it is allowed access to the directory.

The directory replication server uses a unique identity and a password to authenticate with the directory server. The identity of the directory replication server is of the form `cn=replication dn,orclreplicaid=unique_identifier_of_node,cn=replication` configuration.

When it starts, the directory replication server reads its identity and password from an Oracle Internet Directory secure wallet, and uses these credentials for authentication. If you want to change the password for the replication bind DN, then you must use the `-chgpwd`, `-presetpwd`, or `-pchgwlpwd` option of the Replication Environment Management Tool. The wallet for replication identity is located at `ORACLE_INSTANCE/OID/admin/oidpwdrOracle_SID`.

See Also: The `remtool` command-line tool reference in *Oracle Fusion Middleware Reference for Oracle Identity Management*.

Note: In earlier releases, the replication server required the directory server to allow anonymous bind. The replication server no longer requires that.

Secure Sockets Layer (SSL) and Oracle Internet Directory Replication

You can deploy Oracle Internet Directory replication with or without SSL. The replication server automatically detects if it is binding to the SSL port of an Oracle Internet Directory instance. If so, it automatically works on top of the Secure Sockets Layer.

To configure LDAP-based replication to use SSL encryption, specify the port number of the SSL port in the `orclReplicaURI` attribute, which contains the supplier contact information.

To configure Oracle Database Advanced Replication to use SSL encryption, use Oracle Database Advanced Security. See the Secure Sockets Layer chapter in the *Oracle Database Advanced Security Administrator's Guide*.

Note: The replication server cannot communicate over an SSL port that is configured for one-way authentication or two-way authentication. The replication server startup will fail and hang. You must configure the replication server to use either the non-SSL port or an SSL port configured for no authentication. You can use a separate Oracle Internet Directory server instance just for replication.

See Also: [Chapter 26, "Configuring Secure Sockets Layer \(SSL\)"](#).

LDAP Replication Filtering for Partial Replication

This section describes rules and best practices to follow when specifying naming contexts in LDAP partial replication. It contains the following topics:

- [Included and Excluded Naming Contexts in LDAP Replication Filtering](#)
- [Attributes that Control Naming Contexts](#)
- [Rules for LDAP Replication Filtering](#)
- [Examples of LDAP Replication Filtering](#)
- [Rules for Managing Naming Contexts and Attributes](#)
- [Optimization of Partial Replication Naming Context for Better Performance](#)

See Also: ["Content to be Replicated: Full or Partial"](#) on page 6-2.

Included and Excluded Naming Contexts in LDAP Replication Filtering

In LDAP-based replication, you can include a given naming context for replication and exclude one or more of the subtrees within that naming context from replication. You can also exclude from replication one or more of the attributes in that naming context.

In LDAP-based replication, only naming contexts explicitly specified as included are replicated. In Oracle Database Advanced Replication, however, all naming contexts are included by default.

Attributes that Control Naming Contexts

The attributes that control naming contexts are described in "The Replication Naming Context Object Entry" on page 40-6. If you use the Replication Wizard in Oracle Enterprise Manager Fusion Middleware Control to set up replication, you set these attributes on the Scope page.

Rules for LDAP Replication Filtering

When two or more naming context objects are configured for replication, the filtering rules are as follows:

1. The overall included naming context is the union of all included naming contexts defined in each naming context object.
2. The overall excluded naming contexts is the union of all excluded naming contexts defined in each naming context object.
3. The attribute exclusions in a naming context object are specific only to that naming context object.
4. If there is a conflict between an included naming context and an excluded naming context, the excluded naming context overrules the included naming context. For example, if an included naming context in naming context object A is a subtree of an excluded naming context specified in another naming context object, B, the subtrees specified in `orclxcludednamingcontexts` of naming context object B are not replicated. That is, replication filtering in naming context object A is ignored.
5. If you configure partial replication between two different versions of Oracle Internet Directory (for example 10g (10.1.4.0.1) and 11g Release 1 (11.1.1)), then you cannot exclude a naming context. Instead, you must explicitly specify the naming contexts to be replicated as included naming contexts.

Examples of LDAP Replication Filtering

The discussion in this section relies on the sample naming context illustrated in Figure 38-1. A partial list of user attributes is shown under `cn=user1`, `cn=user2`, and `cn=user1000`.

Figure 38-1 A Sample Naming Context

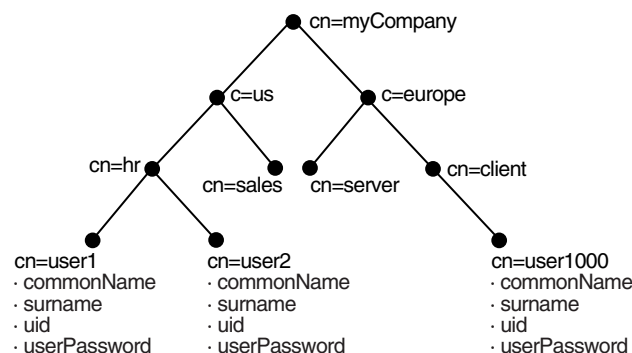

See Also: "Replication Schema Elements" in *Oracle Fusion Middleware Reference for Oracle Identity Management* for descriptions of the attributes in the replication naming context entry

The following examples show how these rules work:

- Scenario A: The Included Naming Context in One Naming Context Object Is a Subtree of the Included Naming Context in Another Naming Context Object
- Scenario B: The Included Naming Context in One Naming Context Object Is a Subtree of An Excluded Naming Context in Another Naming Context Object
- Rules for Managing Naming Contexts and Attributes
- Optimization of Partial Replication Naming Context for Better Performance

Scenario A: The Included Naming Context in One Naming Context Object Is a Subtree of the Included Naming Context in Another Naming Context Object

In this scenario, the included naming context in naming context object #2 is a subtree of the included naming context in object #1.

Naming Context Object #1

```
dn:cn=namectx001,
cn=replication namecontext,
orclagreementid=unique_identifier_of_the_replication_agreement,
orclreplicaid=unique_identifier_of_the_supplier,
cn=replication configuration
orclincludednamingcontexts: cn=mycompany
```

Naming context object #1 includes the entire DIT under `cn=myCompany`, as shown in [Figure 38-2](#).

Figure 38-2 Naming Context Object #1

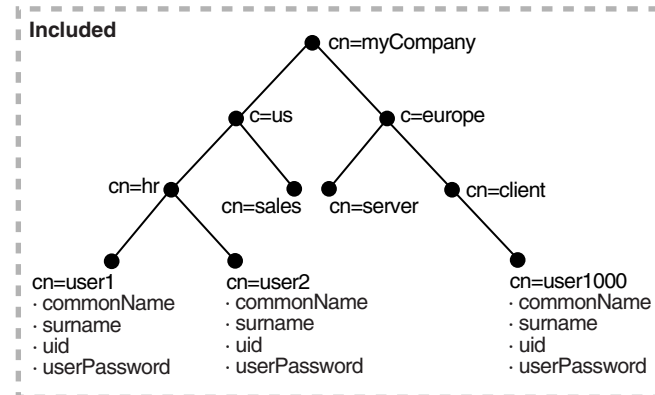

Naming Context Object #2

```
dn:cn=namectx002,
cn=replication namecontext,
orclagreementid=unique_identifier_of_the_replication_agreement,
orclreplicaid=unique_identifier_of_the_supplier,
cn=replication configuration
orclincludednamingcontexts: cn=hr,c=us,cn=mycompany
orcl'excludednamingcontexts: cn=user1,cn=hr,c=us,cn=mycompany
orcl'excludedattributes: userPassword
```

Naming context object #2 includes the DIT under `cn=hr`, `c=us`, `cn=mycompany`, but excludes `cn=user1` and the attribute `userPassword`, as shown in [Figure 38-3](#).

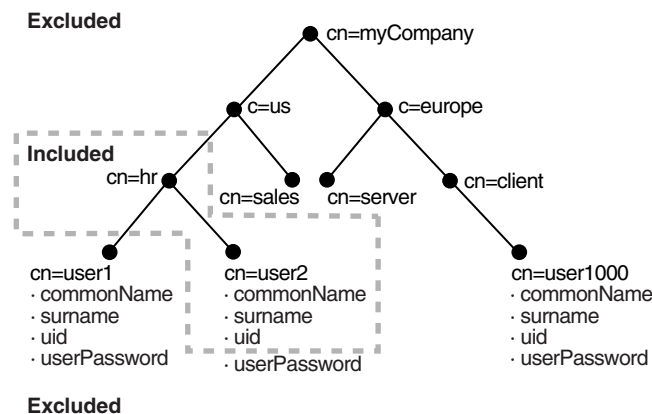
Figure 38–3 Naming Context Object #2

The result of combining naming context objects #1 and #2 is shown in [Figure 38–4](#).

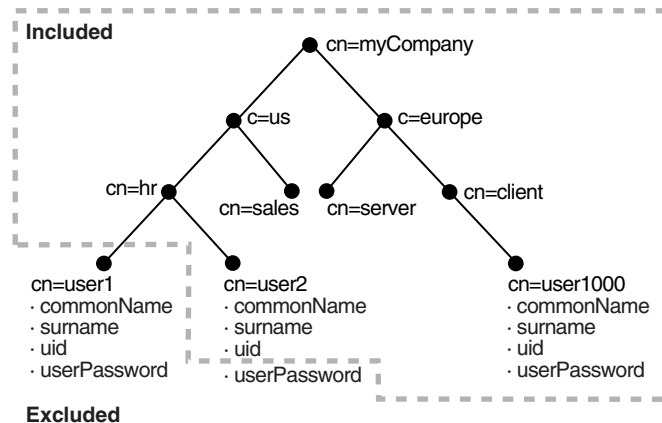
Figure 38–4 Result of Combining Naming Context Objects #1 and #2

In this scenario, the naming context that is replicated is the highest one specified in the `orclincludednamingcontexts` attribute. Any excluded naming contexts are not replicated. All changes under the subtree `cn=mycompany` are replicated, except for `cn=user1`, `cn=hr`, `c=us`, `cn=mycompany` and the attribute `userPassword` under `cn=hr`, `c=us`, `cn=mycompany`, which are excluded. The attribute `userPassword` under the rest of the DIT, however, is not excluded from replication because exclusion of `userPassword` was specified only for naming context object #2, which only included the DIT under `cn=hr`.

Scenario B: The Included Naming Context in One Naming Context Object Is a Subtree of An Excluded Naming Context in Another Naming Context Object

In this scenario, the excluded naming context in naming context object #4 is a subtree of the excluded naming context defined in naming context object #3.

Naming Context Object #3

```
dn:cn=namectx001,cn=replication namecontext,
  orclagreementid=identifier,orclreplicaid=supplier,cn=replication configuration
orclincludednamingcontexts: cn=mycompany
orcl'excludednamingcontexts: c=us,cn=mycompany
```

Naming context object #3 excludes everything under `c=us`, `cn=mycompany`, as shown in [Figure 38-5](#).

Figure 38-5 Naming Context Object #3

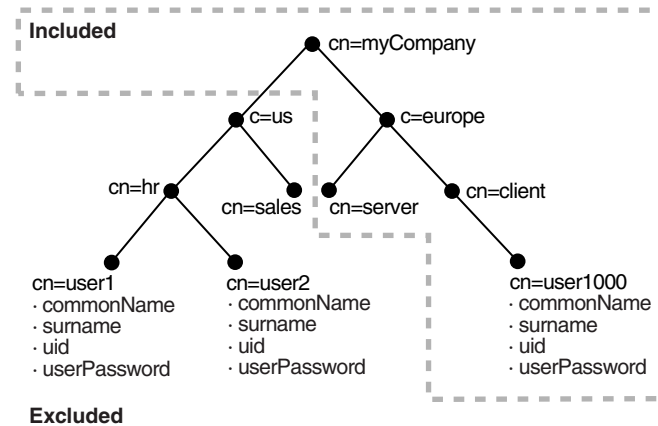

Naming Context Object #4

```
dn:cn=namectx002,cn=replication
namecontext,orclagreementid=identifier,orclreplicaid=supplier,
cn=replication configuration
orclincludednamingcontexts: cn=hr, c=us,cn=mycompany
orclxcludednamingcontexts: cn=user1,cn=hr,c=us,cn=mycompany
orclxcludedattributes: userPassword
```

Naming context object #4 includes the DIT under `cn=hr`, `c=us`, `cn=mycompany` but excludes `user1`, and the `userPassword` attribute for all users, as shown in [Figure 38-6](#).

Figure 38-6 Naming Context Object #4

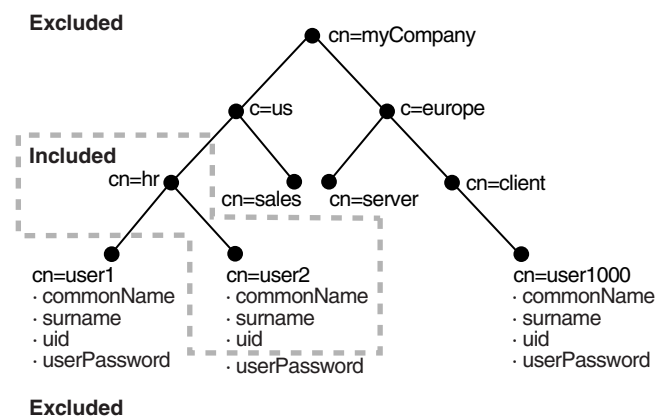

The result of combining naming context objects #3 and #4 is shown in [Figure 38-7](#).

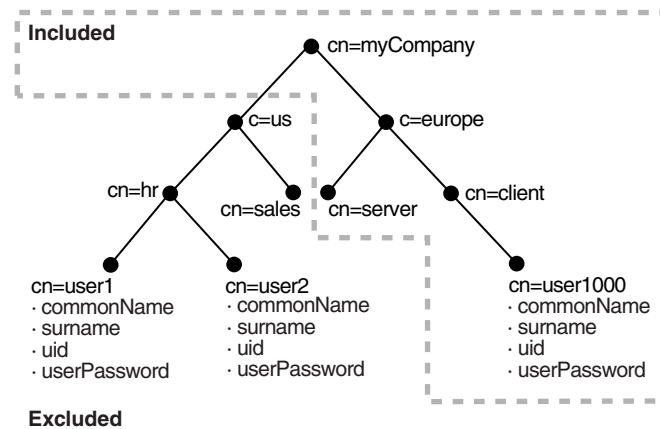
Figure 38-7 Result of Combining Naming Context Objects #3 and #4

In this scenario, the included naming context specified in naming context object #4 is not replicated. That naming context is a subtree of a specified excluded naming context in naming context object #3. In this case, naming context object #4 is ignored, and no changes under `cn=hr`, `c=us`, `cn=mycompany` are replicated.

Rules for Managing Naming Contexts and Attributes

The following naming contexts cannot be replicated:

- DSE root-specific entry
- `orclagreementid=000001,cn=replication` configuration
- `cn=subconfigsubentry`
- `cn=Oracle Internet Directory`
- `cn=subregistrysubentry`

The following naming contexts cannot be excluded from replication:

- `cn=catalogs`
- `cn=subschemasubentry`
- `cn=oracleschemaversion`
- `cn=replication` configuration

The following attributes cannot be excluded from replication whether they are mandatory or optional. Even if you specify attributes in this list for exclusion from replication, they are always replicated.

- `orclguid`
- `creatorsname`
- `createtimestamp`
- `cn`
- `dn`
- `attributetypes`
- `objectclasses`
- `objectclass`
- `orclindexedattribute`

- `orclproductversion`

You cannot exclude mandatory attributes from replication. For example, suppose that you have an object class named `my_object_class`, which includes the following attributes: `mandatory_attribute_1`, `optional_attribute_1`, and `optional_attribute_2`. In this case, you cannot exclude from replication `mandatory_attribute_1`.

If you attempt to exclude from replication an attribute that is a mandatory attribute for an entry, replication server still replicates that attribute.

In partial replication, when a naming context is changed from included to excluded using the `moddn` operation, the replication server deletes the naming context at the consumer. Similarly, if the naming context is changed from excluded to included by using `modn` at the supplier, then the replication server synchronizes the entire naming context from supplier to consumer.

Optimization of Partial Replication Naming Context for Better Performance

You must plan partial replication carefully to avoid degrading the performance of the replication process. For best performance, use as few naming context objects as possible. For example, the combined use of naming context objects #5 and #6 fulfills the same requirement as the use of naming context object #7, but using naming context object #7 provides better performance.

This section contains these examples:

- [Naming Context Object #5](#)
- [Naming Context Object #6](#)
- [Naming Context Object #7](#)

Naming Context Object #5

```
cn=namectx001,cn=replication
namecontext,orclagreementid=identifier,orclreplicaid=supplier,cn=replication
configuration
orclincludednamingcontexts: cn=mycompany
orcl'excludednamingcontexts: c=europe,cn=mycompany
orcl'excludedattributes: userPassword
```

Naming context object #5 is shown in [Figure 38–8](#). It includes the DIT under `cn=mycompany`, but excludes everything under `c=europe`. It also excludes the attribute `userPassword`.

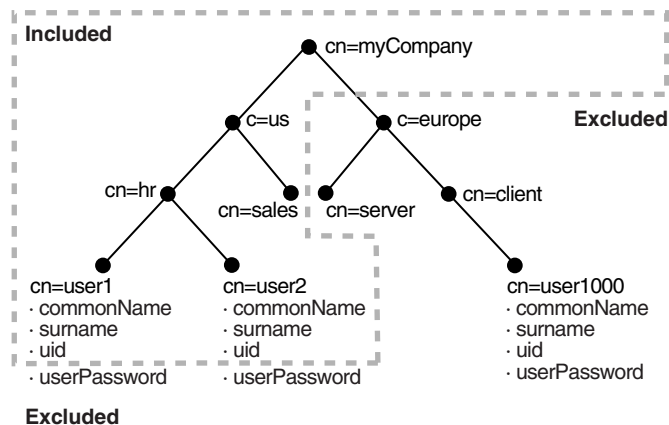
Figure 38–8 Naming Context Object #5**Naming Context Object #6**

```

cn=namectx002,cn=replication
namecontext,orclagreementid=<id>,orclreplicaid=<supplier>,cn=replication
configuration
orclincludednamingcontexts: cn=hr, c=us,cn=mycompany
orcl'excludednamingcontexts: cn=user1,cn=hr, c=us,cn=mycompany
orcl'excludedattributes: userPassword
  
```

Naming context object #6 is shown in [Figure 38–9](#). It includes the DIT under `cn=hr`, `c=us`, `cn=mycompany` but excludes `user1` and the attribute `userPassword`.

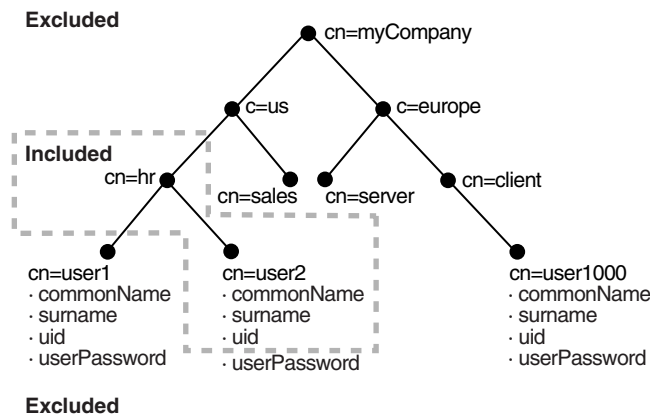
Figure 38–9 Naming Context Object #6

If naming context objects #5 and #6 are combined, then all changes under `cn=mycompany` are replicated, except for `c=europe`, `c=mycompany`, `cn=user1`, `cn=hr`, `c=us`, `cn=mycompany`, and the attribute `userPassword`.

You could fulfill the same requirement, however, by using naming context object #7. Using a single naming context object provides better partial replication performance.

Naming Context Object #7

```

cn=namectx001,cn=replication
namecontext,orclagreementid=identifier,orclreplicaid=supplier,cn=replication
configuration
orclincludednamingcontexts: cn=mycompany
orcl'excludednamingcontexts: c=europe,cn=mycompany
  
```



```
orcllexcludednamingcontexts: cn=user1,cn=hr, c=us,cn=mycompany
orcllexcludedattributes: userPassword
```

Naming context object #7 is shown in [Figure 38-10](#).

Figure 38-10 Naming Context Object #7

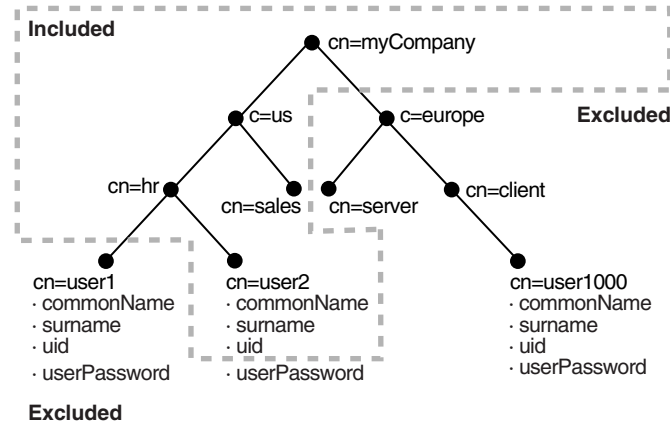

Converting an Advanced Replication-Based Agreement to an LDAP-Based Agreement

You can convert an existing Oracle Database Advanced Replication-based agreement between two or more nodes to an LDAP multimaster agreement by using `remtool -asr2ldap`. The tool prompts you for information. For example:

```
remtool -asr2ldap
```

```
Enter replication administrator's name      : repadmin
```

```
Enter replication administrator's password :
```

```
Enter global name of MDS                   : inst1.regress.rdbms.dev.example.com
```

```
Directory Replication Group (DRG) details :
```

```
-----
```

Instance Name	Host Name	Global Name	Version	Replicaid	Site Type
tst1	stacu14	INST1.REGRESS.RDBMS.DEV	OID 11.1.1.0.	stacu14_tst1	MDS
tst12	stacu14	INST2.REGRESS.RDBMS.DEV	OID 11.1.1.0.	stacu14_tst12	RMS

```
-----
```

```
Do you want to continue? [y/n] : y
```

```
-----
```

```
Migrating ASR agreement to LDAP MM agreement...
```

```
Enter "SYSTEM" user password for "INST2.REGRESS.RDBMS.DEV.EXAMPLE.COM" database at "stacu14" host :
```

```
Enter "SYSTEM" user password for "INST1.REGRESS.RDBMS.DEV.example.com" database at "stacu14" host :
```

```
-----
```

```
ASR setup has been cleaned up.
```

```
-----
```

Setting Up an LDAP-Based Replication Agreement by Using the Replication Wizard

You configure a one-way, two-way, or multimaster LDAP replica by using the Replication Wizard in Oracle Enterprise Manager Fusion Middleware Control.

See Also: ["Direction: One-Way, Two-Way, or Peer to Peer"](#) on page 6-3

Note: You cannot use the Replication Wizard in Oracle Enterprise Manager Fusion Middleware Control to configure an Oracle Database Advanced Replication-based replication agreement. You must do that from the command line.

You configure an LDAP replication agreement as follows.

1. From the Oracle Internet Directory menu on the home page, select **Administration**, then **Replication Management**.
2. You are prompted to log into the replication DN account. Provide the host, port, replication DN, and replication DN password. If anonymous binds are enabled on this OID component, the replication DN, host, and port fields fill in automatically and are greyed out. You only need to enter the password.
3. Click the **Create** icon.
4. On the Type screen, select the replication type: **One Way Replication**, **Two Way Replication**, or **Multimaster Replication**.
5. Click **Next**. The **Replicas** screen displays the replication type you selected.
6. Provide an agreement name. This must be unique across all the nodes.
7. For one way or two way replication, enter the host, port, user name (replication DN), and replication password for the consumer node. Fields for the supplier node are populated and greyed out.

For multimaster replication, enter the host, port, user name (replication DN), and replication password for the secondary nodes. Fields for the primary node are populated and greyed out.
8. Click **Next** to go the Settings page.
9. In the LDAP Connection field, select **Keep Alive** if you want the replication server to use same connection for performing multiple LDAP operations. Select **Always Use New Connection** if you want the server to open a new connection for each LDAP operation.
10. Enter the Replication Frequency.
11. Enter the **Human Intervention Queue Schedule**. This is the interval, in seconds, at which the directory replication server repeats the change application process.
12. If you have specified **Two Way Replication** or **Multimaster Replication** as the agreement type, the settings page contains a section called Replication Server Start Details. You can select **Start Server** to start the server instance and you can enable bootstrap by selecting **Enable Bootstrap**. First select the host, then select **Instance Name** and **Component Name** for that host. Then you can select **Start Server** or **Enable Bootstrap** or both.

13. Click **Next** to go to the **Scope** page. The default primary naming context is filled in.
14. To exclude a secondary naming context within the default primary naming context, select the primary naming context and click the **Create** button. Then proceed to Step 16.
15. To create another primary naming context, click the **Create Primary Naming Context** button. This invokes the Primary Naming Context dialog.
To specify a primary naming context, either enter the DN manually in the Primary Naming Context field or click **Select** and browse to the DN you want to use as your primary naming context. Select the container and click **OK**.
16. To exclude a secondary naming context, click the **Add** icon below the Excluded Secondary Naming Contexts field. This invokes the Select Secondary Naming Context to be Excluded dialog. Select the naming context and click **OK**. The naming context appears in the Excluded Secondary Naming Contexts field.
17. To exclude an attribute, click the **Add** icon below the ExcludedAttributes field. This invokes the Select Excluded Attributes screen. Select the attributes you want to exclude and click **OK**. The attribute now appears in the **Excluded Attributes** field.
18. Click **OK**. The primary naming context is now listed on the **Scope** page.
19. Click **Next**. The Summary page displays a summary of the replication agreement you are about to create.
20. Click **Finish** to create the replication agreement.

Testing Replication by Using Oracle Directory Services Manager

Use Oracle Directory Services Manager to test directory replication by doing the following:

1. Invoke Oracle Directory Services Manager and connect to the Oracle Internet Directory server as described in "[Invoking Oracle Directory Services Manager](#)" on page 7-9.
2. From the task selection bar, select **Data Browser**.
3. Create a single entry on the MDS node, as described in "[Adding a New Entry by Using Oracle Directory Services Manager](#)" on page 13-6.

The identical entry appears in approximately 1 to 10 minutes on the RMS. You can adjust the timing in the replication server configuration set entry. If entries are modified on any nodes in the DRG, then the changes are replicated.

Setting Up an LDAP-Based Replication by Using the Command Line

This section contains these topics:

- [Copying Your LDAP Data by Using ldifwrite and bulkload](#)
- [Setting Up an LDAP-Based Replica with Customized Settings](#)
- [Password Policy and Fan-out Replication](#)
- [Deleting an LDAP-Based Replica](#)

See Also: "[Direction: One-Way, Two-Way, or Peer to Peer](#)" on page 6-3

Copying Your LDAP Data by Using `ldifwrite` and `bulkload`

You can use `ldifwrite` and `bulkload` to copy LDAP data from one host to another. Use the `ldifwrite` utility to back up LDAP data with operational attributes preserved. After this is done, use the `bulkload` utility to load data to all replicas in a group.

Use `bulkload` with the `check="TRUE"`, `generate="TRUE"`, and `restore="TRUE"` arguments, and then with the `load="TRUE"` argument. Preserve the operational attributes by using the same intermediate files (generated by using the `generate="TRUE"` argument) for all replicas. You can load multiple replicas in the same invocation of the `bulkload` command by using `connect="connect_string"` with the appropriate connect string for each replica.

Using this method can take a long time for a directory with one million entries.

See Also:

- [Chapter 15, "Performing Bulk Operations"](#)
- [Chapter 25, "Backing Up and Restoring Oracle Internet Directory"](#)
- "Oracle Identity Management Command-line Tool Reference" in *Oracle Fusion Middleware Reference for Oracle Identity Management*

Setting Up an LDAP-Based Replica with Customized Settings

To establish customized settings, you must first install the new node. To do so, follow the instructions in *Oracle Fusion Middleware Installation Guide for Oracle Identity Management*.

After configuring LDAP-based replication with `remtool`, you can customize the `namingcontext` defining what is replicated for that LDAP-based node.

See Also: The discussion of naming contexts in ["Modifying What Is to Be Replicated in LDAP-Based Partial Replication"](#) on page 41-2.

There are two ways to set up an LDAP-based replica with customized setting, based on how you will migrate the data from the directory:

- Use the command-line tools. Use `ldifwrite` to backup the data from the supplier replica, then use `bulkload` to restore the data to the consumer replica
- Use automatic bootstrapping. This is a replication server feature that automatically bootstrap the data from the supplier replica to the consumer replica, based upon replication configuration.

[Table 38–1](#) compares these two methods.

Table 38–1 Data Migration Using `ldifwrite/bulkload` versus Automatic Bootstrapping

Migration Using <code>ldifwrite/bulkload</code>	Migration Using Automatic Bootstrapping
Manual procedure	Automatic procedure
Faster performance	Uses the filtering capability of partial replication
Good for a large amount of data	Good for a smaller number of entries

If automatic bootstrapping is your chosen data migration method, customize your LDAP-based replica using ["Setting Up an LDAP-Based Replica by Using Automatic Bootstrapping"](#) on page 38-19.

If `ldifwrite/bulkload` is your chosen data migration method, configure your LDAP-based replica using "[Setting Up an LDAP-Based Replica by Using the `ldifwrite Tool`](#)" on page 38-24.

Setting Up an LDAP-Based Replica by Using Automatic Bootstrapping

The following eight tasks enable you to configure an LDAP-based replica by using automatic bootstrapping. They are explained in the paragraphs that follow this list.

- [Task 1: Identify and Start the Directory Server on the Supplier Node](#)
- [Task 2: Create the New Consumer Node by Installing Oracle Internet Directory](#)
- [Task 3: Back Up the Metadata from the New Consumer Node](#)
- [Task 4: Add an LDAP-Based Replica by Using the Replication Environment Management Tool](#)
- [Task 5: On the Consumer, Configure the Consumer Replica for Automatic Bootstrapping](#)
- [Task 6: Optional: Change Default Replication Parameters](#)
- [Task 7: Ensure the Directory Replication Servers are Started](#)
- [Task 8: If Oracle Delegated Administration Services or Oracle Single Sign-On Are Installed on the New Node, Restore Their Entries in the New Node's Directory](#)

Task 1: Identify and Start the Directory Server on the Supplier Node Identify the supplier for an LDAP-based replica. The supplier can be

- A directory that is not a member of any replication group
- A node of a multimaster replication group
- Another LDAP-based replica

Make sure the Oracle Internet Directory server is started on the Supplier node. To start the directory server, type the following command:

```
opmnctl startproc ias_component=oid1
```

Task 2: Create the New Consumer Node by Installing Oracle Internet Directory Install a new Oracle Internet Directory on the replica, as documented in *Oracle Fusion Middleware Installation Guide for Oracle Identity Management*.

Task 3: Back Up the Metadata from the New Consumer Node Before configuring the new node as an LDAP-based replica with customized settings, you must first migrate its metadata to the supplier node, as follows:

- Make sure the Oracle Internet Directory server is up and running on both the supplier node and the new node created in Task 2, so that the backup process (`remtool -backupmetadata`) can succeed.
- From the newly created node, run the following command:

```
remtool -backupmetadata \  
-replica "new_node_host:new_node_port" \  
-master "master_host:master_port"
```

where `master_host:master_port` are the hostname and port number for the desired replica's supplier. you are prompted for replication DN password.

Note: If Oracle Delegated Administration Services is not configured, you might see an error message similar to this when you run `remtool` with the `-backupmetadata` option:

```
Failed to add "orclApplicationCommonName=ias.example.com,
cn=IAS Instances, cn=IAS, cn=Products, cn=OracleContext"
as "uniquemember" to entry "cn=Associated Mid-tiers,
orclapplicationcommonname=DASApp, cn=DAS,cn=products,
cn=OracleContext" at replica ldap://myhost:3060
```

Please ignore this error message.

See Also: The `remtool` command-line tool reference in *Oracle Fusion Middleware Reference for Oracle Identity Management* for more information about `remtool` options, including `-backupmetadata`.

- Apart from loading the metadata into master replica, this command creates a file named `ocbkup.new_replica_id.TO.master_replicaid.timestamp.ldif` containing the metadata as back up. This file is created under the `ORACLE_INSTANCE/diagnostics/logs/OID/tools` directory. This file contains the changes made to master replica in LDIF format, a copy of the SSO container entry [`orclApplicationCommonName=ORASSO_SSO_SERVER, cn=SSO, cn=Products, cn=OracleContext`] and DAS URL container entry [`cn=OperationURLs, cn=DAS, cn=Products, cn=OracleContext`].

- If the metadata backup succeeds, it shows the following message in the terminal:

```
Backup of metadata will be stored in ORACLE_INSTANCE/diagnostics
/logs/OID/tools/ocbkup.replicaid_pilot.TO.replicaid_master.timestamp.ldif.
```

```
Metadata copied successfully.
```

The message contains the path of your `ORACLE_INSTANCE` and filename.

- If the metadata backup is unsuccessful, the `ORACLE_INSTANCE/diagnostics/logs/OID/tools/remtool.log` file contains error messages. If you invoked `remtool` from a terminal, error messages appear on that terminal.

Task 4: Add an LDAP-Based Replica by Using the Replication Environment Management Tool To add a replica, enter the following on the consumer replica:

```
remtool -paddnode [-v] [-bind supplier_host_name:port]
```

you are prompted for the `replication_dn_password`.

The `remtool` utility prompts for agreement type. Select One-Way, Two-Way, or Multimaster LDAP, depending on which type of replica you are adding.

you are prompted for the replica ID of the supplier. This is the value of the attribute `orclreplicaid` in the root DSE entry. To find the value to supply, type:

```
ldapsearch -D cn=orcladmin -q -p port -b "" -s base "objectclass=*" orclreplicaid
```

you are prompted for the list of available naming contexts in the supplier replica. If you are planning to set up partial replication between server instances running different versions of Oracle Internet Directory, enter `e`.

After `remtool` has completed successfully, add a separate naming context for each subtree to be replicated, as follows:

1. Determine the replica ID of the supplier and consumer replica nodes by executing the following search command on both nodes:

```
ldapsearch -h host -p port -D cn=orcladmin -q -b "" \
-s base "objectclass=*" orclreplicaid
```

2. Determine the replication agreement entry, which is of the form:

```
"orclagreementid=unique_identifier_of_the_replication_agreement,orclreplicaid=supplier_replica_id,cn=replication configuration"
```

To find it, type:

```
ldapsearch -D cn=orcladmin -q -h supplier_host -p supplier_port \
-b "orclreplicaid=supplier_replica_id,cn=replication configuration" \
-s sub "(&(orclreplicadn=consumer_replica_id)(objectclass=orclreplagreemententry))" dn
```

3. For each naming context that you plan to include in replication, add an entry like the following on both the consumer and supplier replica nodes. The following LDIF file specifies a naming context (subtree) to be included in replication and a some attributes to exclude from replication.

```
dn: cn=includednamingcontext000002,
cn=replication namecontext,orclagreementid=000003,
orclreplicaid=stajv18_oid10143,cn=replication configuration
objectclass: top
objectclass: orclreplnamectxconfig
orclincludednamingcontexts: cn=users,dc=small,dc=com
orclexcludedattributes: userpassword
orclexcludedattributes: telephonenumber
cn: includednamingcontext000002
```

Add the LDIF file to Oracle Internet Directory on the consumer and supplier replica using the following LDAP add command:

```
ldapadd -D cn=orcladmin -q -h host -p port -v -f ldif_file
```

4. Repeat Step3 for each naming context (subtree) to be configured in partial replication.

See Also:

- The `remtool` command-line tool reference in *Oracle Fusion Middleware Reference for Oracle Identity Management* for more information about the Replication Environment Management Tool
- ["LDAP Replication Filtering for Partial Replication"](#) on page 38-7.

Task 5: On the Consumer, Configure the Consumer Replica for Automatic Bootstrapping To use the automatic bootstrap capability, on the consumer, set the `orclReplicaState` attribute of the consumer replica subentry to 0 as follows:

1. Edit the sample file `mod.ldif` as follows:

```
Dn: orclreplicaid=unique_replicaID_of_consumer, cn=replication configuration
Changetype:modify
```

```
replace:orclReplicaState
OrclReplicaState: 0
```

Note: On Windows systems, ensure that the replication server is not running before you enable bootstrapping by changing the value of `orclReplicaState` to 0.

2. Use `ldapmodify` at the consumer to update the consumer replica's subentry `orclreplicastate` attribute.

```
ldapmodify -D "cn=orcladmin" -q -h consumer_host -p port -f mod.ldif
```

See Also: [Chapter 41, "Managing and Monitoring Replication"](#) for more information about the bootstrap capability of the LDAP-based replication

Task 6: Optional: Change Default Replication Parameters You can change the default parameters for replication agreements and for the replica subentry.

See Also:

- [Chapter 40, "Managing Replication Configuration Attributes"](#)
- ["Modifying What Is to Be Replicated in LDAP-Based Partial Replication"](#) on page 41-2

Task 7: Ensure the Directory Replication Servers are Started The exact procedure for starting the replication servers depends on whether this is a one-way or a two-way replica or multimaster replica.

- For one-way LDAP replication, you must start the replication server at the consumer. For example, to start the replication server at `oid1`, type:

```
oidctl connect=connStr server=oidrepld instance=1 \
name=asinst_1component name=oid1 \
flags="-h consumer_host -p consumer_port" start
```

Note: If you are deploying a single master with read-only replica consumers, you can reduce performance overhead by turning off conflict resolution. To do so, change the value of `orclconflresolution` to 0 by using the following `ldif` file with `ldapmodify`:

```
dn: cn=configset0,cn=osdrepld,cn=subconfigsubentry
changetype: modify
replace: orclconflresolution
orclconflresolution: 0
```

- For two-way or multimaster LDAP replication, you must start the Oracle Internet Directory replication server at each node, as follows:

```
oidctl connect=connStr server=oidrepld instance=1 \
name=instance_name componentname=component_name flags="-h \
LdapHost -p LdapPort" start
```

When the replication server is started, it starts to bootstrap the data from the supplier to the consumer. After the bootstrap has completed successfully, the replication server automatically change to ONLINE mode (`orclreplicastate=1`) to process changes from the supplier to the consumer. You can monitor the value of `orclreplicastate` by using the following command line:

```
ldapsearch -p port-h host -D cn=orcladmin -q \
  -b "orclreplicaid=unique_replicaID_of_consumer, cn=replication configuration" \
  -s base "objectclass=*" orclreplicastate
```

Task 8: If Oracle Delegated Administration Services or Oracle Single Sign-On Are Installed on the New Node, Restore Their Entries in the New Node's Directory The entries for Oracle Delegated Administration Services and Oracle Single Sign-On must refer to the local instances of these services. However, the initial replication download from the supplier to the consumer creates these entries with values replicated from the supplier. If these services are in fact configured on the consumer node, then these values need to be replaced by the correct information appropriate to the consumer node.

- If the Delegated Administration Service (DAS) is configured on the consumer node, it must be restored using the following steps:
 1. In the `ocbkup.new_replicaid.TO.master_replicaid.timestamp.ldif` file created by Task 3, locate and copy the DAS URL. The DN of the DAS URL container entry is "cn=OperationURLs, cn=DAS, cn=Products, cn=OracleContext". It is usually the next-to-last entry in the file.

See Also: *Oracle Identity Management Guide to Delegated Administration* and *Oracle Application Server Single Sign-On Administrator's Guide* in the 10g (10.1.4.0.1) library.

2. Create an LDIF file called `change_das_url.ldif` with the following contents:

```
dn: cn=OperationURLs,cn=DAS,cn=Products,cn=OracleContext
changetype: modify
replace: orcldasurlbase
orcldasurlbase: copy_paste_the_URL_from_backup_file
```

3. Execute the following command to change the DAS URL:

```
ldapmodify -p consumer_port -h consumer_host -D super_user_DN \
  -q -f change_das_URL.ldif
```

- Similarly, if Single Sign-on (SSO) is configured on the consumer node, it must be restored using the following steps:
 1. In the `ocbkup.timestamp.dat` file created by Task 3, locate and copy the SSO container entry. Copy only the attributes shown in step 2. The DN of the SSO container entry is "orclApplicationCommonName=ORASSO_SSOSERVER, cn=SSO, cn=Products, cn=OracleContext". It is usually the last entry in the file.

See Also: *Oracle Application Server Single Sign-On Administrator's Guide* in the 10g (10.1.4.0.1) library.

2. Create an LDIF file `add_SSO_container.ldif` with the following contents:

```
dn: orclApplicationCommonName=ORASSO_SSOSERVER,
  cn=SSO,cn=Products,cn=OracleContext
```

```

orclapplicationcommonname: ORASSO_SSOSERVER
orclappfullname: ORASSO_SSOSERVER
orclversion: 10.1.2.0.0
objectclass: orclApplicationEntity
objectclass: top
userpassword: userpassword_copied_from_backup_file

```

Note: Do not copy the authpassword; oid, createtimestamp, creatorsname, modifiersname, modifytimestamp, or orclguid attributes.

3. Execute the following command to add the SSO container entry:

```

ldapadd -p consumer_port -h consumer_host -D super_user_DN \
-q -f add_SSO_container.ldif

```

4. Create an LDIF file mod.ldif with the following contents:

```

dn: cn=OracleUserSecurityAdmins,cn=Groups,cn=OracleContext
changetype:modify
add: uniquemember
uniquemember: orclApplicationCommonName=ORASSO_SSOSERVER,
cn=SSO,cn=Products,cn=OracleContext

```

```

dn: cn=verifierServices, cn=Groups,cn=OracleContext
changetype:modify
add: uniquemember
uniquemember: orclApplicationCommonName=ORASSO_SSOSERVER,
cn=SSO,cn=Products,cn=OracleContext

```

5. Execute the following command to apply mod.ldif:

```

ldapmodify -p consumer_port -h consumer_host -D super_user_DN \
-q -f mod.ldif

```

6. Using a browser, test the Oracle Delegated Administration Services and Oracle Single Sign-On pages.

To test Oracle Delegated Administration Services, try to log in as the admin user "orcladmin" on the Oracle Delegated Administration Services page, `http(s)://new_node_hostname:new_node_http_port/oiddas/`. If you cannot log in, see the troubleshooting appendix in *Oracle Identity Management Guide to Delegated Administration*, in the 10g (10.1.4.0.1) library.

To test Oracle Single Sign-On, try to log in as the super admin user "orcladmin" on the Oracle Single Sign-On page, `http(s)://new_node_hostname:new_node_http_port/pls/orasso/`. If you cannot log in, see the troubleshooting appendix in *Oracle Application Server Single Sign-On Administrator's Guide*, in the 10g (10.1.4.0.1) library.

Setting Up an LDAP-Based Replica by Using the Idifwrite Tool

This section discusses the general tasks you perform when configuring an LDAP-based replica by using the Idifwrite tool. It contains these topics:

- [Task 1: Start the Directory Server on Both the Supplier and the Consumer Nodes](#)
- [Task 2: Back Up the Metadata from the New Consumer Node](#)

- Task 3: Change the Directory Server at the Supplier to Read-Only Mode
- Task 4: Add an LDAP-Based Replica by Using the Replication Environment Management Tool
- Task 5: Back Up the Naming Contexts to Be Replicated
- Task 6: Change the Directory Server at the Supplier to Read/Write Mode
- Task 7: Load the Data on the New Consumer
- Task 8: If Oracle Delegated Administration Services or Oracle Single Sign-On Are Installed on the New Node, Restore Their Entries in the New Node's Directory
- Task 9: Optional: Change Default Replication Parameters
- Task 10: Ensure the Directory Replication Servers are Started

Task 1: Start the Directory Server on Both the Supplier and the Consumer Nodes

1. Identify the supplier for an LDAP-based replica. The supplier can be:
 - A directory that is not a member of any replication group
 - A node of a multi-master replication group
 - Another LDAP-based replica

Make sure the Oracle Internet Directory server is started on the Supplier node. To start the directory server, type the following command:

```
opmnctl startproc ias_component=oid1
```

2. Identify the consumer node, which must be a new Oracle Internet Directory install. To install a new Oracle Internet Directory as a Master, follow the directions in *Oracle Fusion Middleware Installation Guide for Oracle Identity Management*. Make sure the Oracle Internet Directory server is started on the new consumer node. To start the directory server, type the following command:

```
opmnctl startproc ias-component=oid1
```

Task 2: Back Up the Metadata from the New Consumer Node Before configuring the consumer as an LDAP-based replica with customized settings, you must first migrate its metadata to the supplier node, as follows:

- Make sure the Oracle Internet Directory server is up and running on both the supplier node and the new node created in Task 2, so that the backup process (`remtool -backupmetadata`) can succeed.
- From the consumer node, run the following command:

```
remtool -backupmetadata \  
    -replica "consumer_host:consumer_port" \  
    -master "supplier_host:supplier_port"
```

you are prompted for the passwords.

- Apart from loading the metadata into master replica, this tool creates a file named `ocbkup.consumer_replica_id.TO.supplier_replica_id.timestamp.dat` containing the metadata as back up. This file is created in the `ORACLE_INSTANCE/diagnostics/logs/OID/tools` directory. This file contains the changes made to the master replica in LDIF format, a copy of SSO container entry [`orclApplicationCommonName=ORASSO_SSOSERVER, cn=SSO,`

cn=Products, cn=OracleContext] and DAS URL container entry [cn=OperationURLs, cn=DAS, cn=Products, cn=OracleContext].

- If the metadata backup succeeded, `remtool` displays the following message in the terminal:

```
Backup of metadata will be stored in ORACLE_INSTANCE/diagnostics
/logs/OID/tools/ocbkup.replicaid_pilot.TO.replicaid_master.timestamp.ldif.
```

```
Metadata copied successfully.
```

The message contains the path of your `ORACLE_INSTANCE`.

The message contains the actual path of your `ORACLE_INSTANCE` and filename.

If the metadata backup is unsuccessful, the `ORACLE_INSTANCE/diagnostics/logs/OID/tools/remtool.log` file contains error messages. If you invoked `remtool` from a terminal, error messages appear on that terminal.

Task 3: Change the Directory Server at the Supplier to Read-Only Mode To ensure data consistency, change the directory server on the supplier node to read-only. To switch the server from read/write to read-only mode, use one of the procedures in "[Changing Server Mode](#)" on page 15-2.

Task 4: Add an LDAP-Based Replica by Using the Replication Environment Management Tool To add a replica, enter the following on the consumer replica:

```
remtool -paddnode [-v] [-bind supplier_host_name:port]
```

you are prompted for the `replication_dn_password`. The `remtool` utility prompts for agreement type. Select One-Way or Two-Way LDAP, depending on which type of replica you are adding.

See Also: The `remtool` command-line tool reference in *Oracle Fusion Middleware Reference for Oracle Identity Management* for more information about the Replication Environment Management Tool

Task 5: Back Up the Naming Contexts to Be Replicated If there is a large number of entries in the naming contexts that you want to replicate to the LDAP-based replica, then Oracle recommends that you back up these naming contexts at the supplier node and then load them to the LDAP-based replica.

To back up the naming contexts:

1. Identify the replication agreement DN created in "[Task 4: Add an LDAP-Based Replica by Using the Replication Environment Management Tool](#)" on page 38-26.

```
ldapsearch -h supplier_host -p port \
  -b "orclreplicaid=supplier_replicaID,cn=replication configuration" \
  -s sub "(orclreplicadn= orclreplicaid=consumer_replica_ID, \
  cn=replication configuration)" dn
```

2. On the supplier, ensure that `ORACLE_INSTANCE` is set, then use the following command to get the data from the supplier. Data loaded into the file will be based on the agreement configured:

```
ldifwrite connect="connect_string_of_sponsor_node" \
  baseDN="replication_agreement_dn_retrieved_in_step_1" \
  file="name_of_output_LDIF_file"
```

See Also:

- ["Modifying What Is to Be Replicated in LDAP-Based Partial Replication"](#) on page 41-2
- The `ldifwrite` command-line tool reference in *Oracle Fusion Middleware Reference for Oracle Identity Management* for more instructions on using `ldifwrite` to back up part of the naming context

Task 6: Change the Directory Server at the Supplier to Read/Write Mode If you performed ["Task 3: Change the Directory Server at the Supplier to Read-Only Mode"](#) on page 38-26, then change the directory server on the supplier back to read/write mode. Use one of the procedures in ["Changing Server Mode"](#) on page 15-2.

Task 7: Load the Data on the New Consumer To do this:

1. If there are multiple files, then combine them into one file—for example, `backup_data.ldif`.
2. If naming contexts exist on the LDAP-based consumer replica, then remove them by using `bulkdelete`. Ensure `ORACLE_INSTANCE` is set, then enter the following:

```
bulkdelete connect="connect_string_of_replica" baseDN="naming_context"
```

Perform this step for each naming context that was backed up in ["Task 5: Back Up the Naming Contexts to Be Replicated"](#) on page 38-26.

On the consumer, load the data to the replica by using `bulkload` in the append mode. Ensure `ORACLE_INSTANCE` is set, then enter the following:

```
bulkload connect="connect_string_of_replica" append="TRUE" check="TRUE" \
generate="TRUE" restore="TRUE" file="backup_data.ldif"
```

```
bulkload connect="connect_string_of_replica" load="TRUE"
```

Note: If you load data from an earlier version of Oracle Internet Directory, such as 10g Release 2 (10.1.2.0.2) onto a node running 11g Release 1 (11.1.1), you must update the password policy entries as described in ["Password Policy and Fan-out Replication"](#) on page 38-28.

See Also:

- The `bulkload` command-line tool reference in *Oracle Fusion Middleware Reference for Oracle Identity Management* for instructions on using `bulkload` in either the default mode or the append mode
- The `bulkdelete` command-line tool reference in *Oracle Fusion Middleware Reference for Oracle Identity Management*

Task 8: If Oracle Delegated Administration Services or Oracle Single Sign-On Are Installed on the New Node, Restore Their Entries in the New Node's Directory Follow the procedure described in ["Task 8: If Oracle Delegated Administration Services or Oracle Single Sign-On Are Installed on the New Node, Restore Their Entries in the New Node's Directory"](#) on page 38-23.

Task 9: Optional: Change Default Replication Parameters You can change the default parameters for replication agreements, for the replica subentry, and for the replication naming context configuration objects.

See Also:

- [Chapter 40, "Managing Replication Configuration Attributes"](#)
- ["Modifying What Is to Be Replicated in LDAP-Based Partial Replication"](#) on page 41-2

Task 10: Ensure the Directory Replication Servers are Started The exact procedure for starting the replication servers depends on whether this is a one-way or a two-way replica.

- For one-way LDAP replication, you must start the replication server at the consumer. Type:

```
oidctl connect=connStr server=oidrepld instance=1 \
name=instance_name componentname=oidComponentName \
flags="-h LdapHost -p LdapPort" start
```

Note: If you are deploying a single master with read-only replica consumers, you can reduce performance overhead by turning off conflict resolution. To do so, change the value of `orclconflresolution` to 0 by using the following ldif file with `ldapmodify`:

```
dn: cn=configset0,cn=osdrepld,cn=subconfigsubentry
changetype: modify
replace: orclconflresolution
orclconflresolution: 0
```

- For two-way LDAP replication, you must start the Oracle Internet Directory replication servers at both the sponsor replica and the new replica, as follows:

1. Start or restart the replication server at the sponsor replica. Type:

```
oidctl connect=connStr server=oidrepld instance=1 \
name=instance_name componentname=component_name \
flags="-h LdapHost -p LdapPort" start
```

2. Start the replication server at the new replica. Type:

```
oidctl connect=connStr server=oidrepld instance=1 \
name=instance_name componentname=oidComponentName \
flags="-h LdapHost -p LdapPort" start
```

Password Policy and Fan-out Replication

Oracle Internet Directory 11g Release 1 (11.1.1) supports more fine-grained password policies than in releases prior to 10g Release 2 (10.1.2.0.2). This can cause problems when a master node is an earlier version, such as 10g Release 2 (10.1.2.0.2), and the new fan-out node is 11g Release 1 (11.1.1). The password policy entries from the master node might not behave as expected when bootstrapped or migrated to the fan-out node. To correct this problem, as part of the fan-out node setup, after the data from the master is bootstrapped or migrated, you must update the password policy entries by

invoking the Java class `oracle.ldap.oidinstall.backend.OIDUpgradePasswordPolicies`. The command-line syntax is as follows:

```
java -cp ORACLE_HOME/ldap/lib/oidca.jar:ORACLE_HOME/ldap/jlib/ldapjclnt10.jar \
oracle.ldap.oidinstall.backend.OIDUpgradePasswordPolicies host port bindDN \
bindPassword ORACLE_HOME[protocol]
```

Table 38–2 describes the command-line parameters.

Table 38–2 Command-line Parameters to `OIDUpgradePasswordPolicies`

Parameter	Description
<code>host</code>	The host on which the 11g Release 1 (11.1.1) directory server is running
<code>port</code>	The port on which the 11g Release 1 (11.1.1) directory server is listening. If the protocol is <code>ssl</code> , <code>port</code> must be an SSL port.
<code>bindDN</code>	The privileged administrative user, usually <code>cn=orcladmin</code>
<code>bindPwd</code>	The user password associated with the <code>bindDN</code>
<code>ORACLE_HOME</code>	The Oracle home for this instance of Oracle Internet Directory
<code>protocol</code>	An optional parameter. It should be <code>ssl</code> in an SSL environment

All actions performed by the tool are logged to `ppUpgrade.log` in the `ORACLE_HOME\ldap\log` directory.

Note: Before running the tool, ensure that the appropriate environment variable is set correctly:

- On Linux or Solaris, the `LD_LIBRARY_PATH` variable must include `ORACLE_HOME/lib` and `ORACLE_HOME/network/lib`.
 - On 64-bit Solaris, the `LD_LIBRARY_PATH` variable must include `ORACLE_HOME/lib32` and `ORACLE_HOME/network/lib32`.
 - On Windows, the `PATH` variable must include `ORACLE_HOME\bin` and `ORACLE_HOME\network\bin`.
-

See Also: [Chapter 28, "Managing Password Policies"](#)

Deleting an LDAP-Based Replica

This section explains how to delete an LDAP-based replica. It contains these topics:

- [Task 1: Stop the Directory Replication Server on the Node to be Deleted](#)
- [Task 2: Delete the Replica from the Replication Group](#)

Note: You cannot delete a replica if it is a supplier for another replica. To delete such a replica, you must first delete all its consumers from the replication group.

Task 1: Stop the Directory Replication Server on the Node to be Deleted

Stop the Oracle directory replication server by typing:

```
oidctl connect=connStr server=oidrepld instance=1 componentname=oidComponentName \
  flags="-h LdapHost -p LdapPort" stop
```

Task 2: Delete the Replica from the Replication Group

Do this by using the Replication Environment Management Tool. Enter:

```
remtool -pdelnode [-v] [-bind hostname:port_number]
```

See Also: The `remtool` command-line tool reference in *Oracle Fusion Middleware Reference for Oracle Identity Management*

you are prompted for the `replication_dn_password`.

Setting Up a Multimaster Replication Group with Fan-Out

To help you set up a multimaster replication group with fan-out, this section offers an example with four systems as described in [Table 38-3](#).

Table 38-3 Nodes in Example of Partial Replication Deployment

Node	Host Name	Port
Node1	mycompany1.com	3000
Node2	mycompany2.com	4000
Node3	mycompany3.com	5000
Node4	mycompany4.com	6000
Node5	mycompany5.com	7000

In this example, the user has set up the following requirements:

- **Requirement 1:** Node1 and Node2 must be synchronized so that changes made on either node are replicated to the other— but the naming context `cn=private users`, `cn=mycompany` is to be excluded from this replication.
- **Requirement 2:** The naming context `ou=Americas`, `cn=mycompany` on node3 is to be partially synchronized from Node2 so that only changes made under `ou=Americas`, `cn=mycompany` on Node2 are replicated to Node3. The following are to be excluded from this replication:
 - Changes made under `cn=customer profile`, `ou=Americas`, `cn=mycompany`
 - Changes in the attribute `userpassword`.
- **Requirement 3:** Node4 is to be configured as a full replica of node 2, that is, changes to all naming contexts in Node2 are replicated (one-way) to Node4.
- **Requirement 4:** Node5 is to be configured as a two-way (updatable) full replica of Node1.

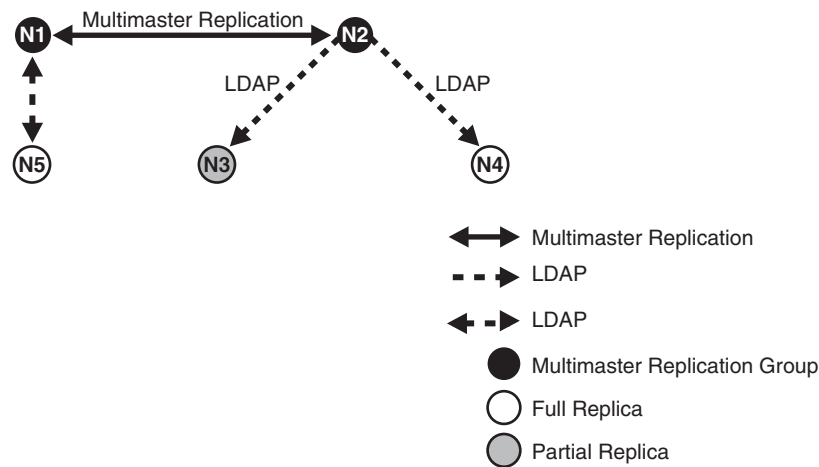
Figure 38-11 Example of Fan-Out Replication

To meet the first requirement in this example, we set up a multimaster replication group for Node1 and Node2. To meet the second, we set up a partial replica for Node2 and Node3, and for the third, full LDAP replication from Node2 to Node4.

This section contains these topics:

- [Task 1: Set up the Multimaster Replication Group for Node1 and Node2](#)
- [Task 2: Configure the Replication Agreement](#)
- [Task 3: Start the Replication Servers on Node1 and Node2](#)
- [Task 4: Test the Directory Replication Between Node1 and Node2.](#)
- [Task 5: Install and Configure Node3 as a Partial Replica of Node2](#)
- [Task 6: Customize the Partial Replication Agreement](#)
- [Task 7: Start the Replication Servers on All Nodes in the DRG](#)
- [Task 8: Install and Configure Node4 as a Full Replica of Node2](#)
- [Task 9: Test the Replication from Node2 to Node4](#)
- [Task 10: Install and Configure Node5 as a Two-Way Replica of Node1](#)
- [Task 11: Test the Two-Way Replication Between Node1 and Node5](#)

Task 1: Set up the Multimaster Replication Group for Node1 and Node2

To set up an LDAP-based multimaster replication group for Node1 and Node2, follow the instructions in "[Setting Up an LDAP-Based Replica with Customized Settings](#)" on page 38-18

If you prefer to use Advanced Replication-based replication for your multimaster replication group, follow Tasks 1 through 5 in "[Setting Up an Advanced Replication-Based Multimaster Replication Group](#)" on page C-4.

Task 2: Configure the Replication Agreement

In the replication agreement between Node1 and Node2, specify the value for the `orclExcludedNamingcontexts` attribute as `cn=private users,cn=mycompany`. To do this:

1. Edit the example file `mod.ldif` as follows:

```
dn: orclAgreementID=000001,cn=replication configuration
```

```

Changetype:modify
Replace: orclExcludedNamingcontexts
orclExcludedNamingcontexts: cn=private users,cn=mycompany

```

- Use `ldapmodify` to update the replication agreement `orclExcludedNamingcontexts` attribute at both Node1 and Node2. To do this, enter:

```

ldapmodify -D "cn=orcladmin" -q -h mycompany1.com -p 3000 -f mod.ldif
ldapmodify -D "cn=orcladmin" -q -h mycompany2.com -p 4000 -f mod.ldif

```

Task 3: Start the Replication Servers on Node1 and Node2

To do this, if you are using LDAP-based replication, follow the instructions on

If you are using Advanced replication, follow the instructions in "[Task 6: Start the Replication Servers on All Nodes in the DRG](#)" on page C-10.

Task 4: Test the Directory Replication Between Node1 and Node2.

To do this, follow the instructions in "[Testing Replication by Using Oracle Directory Services Manager](#)" on page 38-17.

Task 5: Install and Configure Node3 as a Partial Replica of Node2

If you want to use the bootstrap capability of partial replication, then follow Tasks 1 through 5 in "[Setting Up an LDAP-Based Replica by Using Automatic Bootstrapping](#)" on page 38-19.

If you want to configure the replica by using the `ldifwrite` tool, then follow Tasks 1 through 9 in "[Setting Up an LDAP-Based Replica by Using the Ldifwrite Tool](#)" on page 38-24.

Identify Node2 as the supplier and Node3 as the consumer.

Task 6: Customize the Partial Replication Agreement

To do this:

- To achieve Requirement 2 in this example, the default replication between Node2 and Node3 must be configured first:

In partial replication, the `cn=oraclecontext` naming context is replicated by default. You can choose not to replicate it by deleting it at both the supplier (Node2, `mycompany2.com`) and the consumer (Node3, `mycompany3.com`).

```

ldapdelete -D "cn=orcladmin" -q -h mycompany2.com \
-p 4000 "cn=includednamingcontext000001, \
cn=replication namecontext,orclagreementid=000002, \
orclreplicaid==node2_replica_id, \
cn=replication configuration"

```

```

ldapdelete -D "cn=orcladmin" -q -h mycompany3.com \
-p 5000 "cn=includednamingcontext000001, \
cn=replication namecontext,orclagreementid=000002, \
orclreplicaid==node2_replica_id, \
cn=replication configuration"

```

- To replicate the naming context `ou=Americas, cn=mycompany`, and to exclude from replication the naming context `cn=customer profile, ou=Americas, cn=mycompany` and the attribute `userpassword`, create a naming context object as follows:

- a. Edit the example file `mod.ldif` as follows:

```
dn: cn=includednamingcontext000002,cn=replication namecontext,
  orclagreementid=000002,orclreplicaid=node2_replica_id,
  cn=replication configuration
orclincludednamingcontexts: ou=Americas,cn=mycompany
orclxcludednamingcontexts: cn=customer profile, ou=Americas, cn=mycompany
orclxcludedattributes: userpassword
objectclass: top
objectclass: orclreplnamectxconfig
```

- b. Use `ldapadd` to add the partial replication naming context object at both Node2 and Node3.

```
ldapadd -D "cn=orcladmin" -q -h mycompany2.com -p 4000 -f mod.ldif
ldapadd -D "cn=orcladmin" -q -h mycompany3.com -p 5000 -f mod.ldif
```

- If you decide to use the automatic bootstrap capability of partial replication, then edit the example file `mod.ldif` and use `ldapmodify` to modify the partial replica `orclreplicastate` attribute at both Node2 and Node3, as described in "[Task 5: On the Consumer, Configure the Consumer Replica for Automatic Bootstrapping](#)" on page 38-21.

Task 7: Start the Replication Servers on All Nodes in the DRG

To do this, start the replication server at each node.

Type:

```
oidctl connect=connStr server=oidrepld instance=1 \
  componentname=oidComponentName flags="-h LdapHost -p LdapPort" start
```

Task 8: Install and Configure Node4 as a Full Replica of Node2

Since full replica replication is the default configuration when the new node is installed as an LDAP replica, use the instructions in "[Setting Up an LDAP-Based Replication by Using the Command Line](#)" on page 38-17. When the installer prompts for the supplier information, provide the supplier hostname, `mycompany2.com`, the supplier port, 4000, and the superuser password.

Task 9: Test the Replication from Node2 to Node4

Test this replication using the instructions in the section entitled

If you are using Advanced replication, use the instructions in the section "[Task 7: Test Directory Replication](#)" on page C-10

Task 10: Install and Configure Node5 as a Two-Way Replica of Node1

Follow the instructions in "[Setting Up an LDAP-Based Replication Agreement by Using the Replication Wizard](#)" on page 38-16 or in "[Setting Up an LDAP-Based Replication by Using the Command Line](#)" on page 38-17. Provide the supplier hostname, `mycompany1.com`, the supplier port, 3000, and the superuser password.

Task 11: Test the Two-Way Replication Between Node1 and Node5

Create an entry at Node1 using either Oracle Enterprise Manager or the `ldapadd` command-line tool. Wait for the entry to be replicated at Node5. After the entry is replicated to Node5, apply a change to that entry at Node5 using either the `ldapmodify` command-line tool or Oracle Enterprise Manager. The change is replicated to Node1.

Setting Up Replication Failover

This Chapter contains the following topics:

- [Introduction to Replication Failover](#)
- [Performing a Stateless Replication Failover](#)
- [Performing a Time-Based Replication Failover](#)

Introduction to Replication Failover

Since 10g (10.1.4.0.1), Oracle Internet Directory has supported failover of LDAP replicas from one supplier to another. Administrator intervention is required. [Figure 39-1](#) shows a typical failover scenario.

Figure 39-1 Replication Failover Scenario

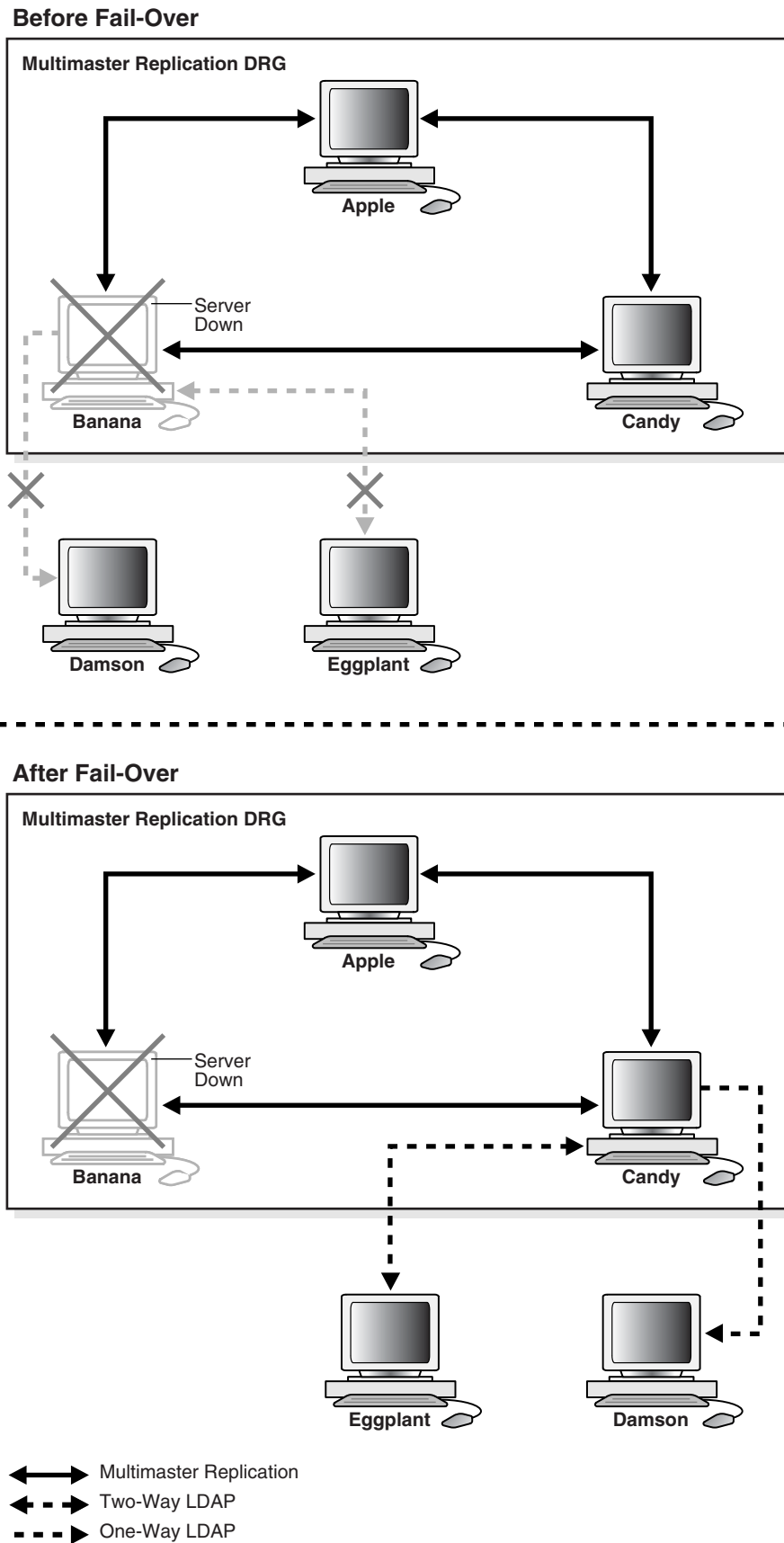

This scenario has the following features:

- Apple, Banana and Candy are multimaster replicas in the same DRG.
- Damson is a read-only fan-out replica of Banana. That is, it is a partial replica using one-way LDAP replication.
- Eggplant is an updatable fan-out replica of Banana. That is, it is a partial replica using two-way LDAP replication.
- If Banana goes down, replication between the multimaster DRG and its fan-out replicas is broken.

An administrator can switch Eggplant and Damson to a new supplier, Candy.

Only two failover topology types are supported:

- The consumer and new supplier are both connected to the old supplier with LDAP-based replication agreements. This is shown in [Figure 39-2](#). Node 1 and Node 3 both have LDAP replication agreements with Node 2. Node 2 is the original supplier for Node 1. When Node 2 fails, you can fail over Node 1 to a new supplier, Node 3.

Figure 39-2 Consumer and New Supplier Connected to Old Supplier by LDAP

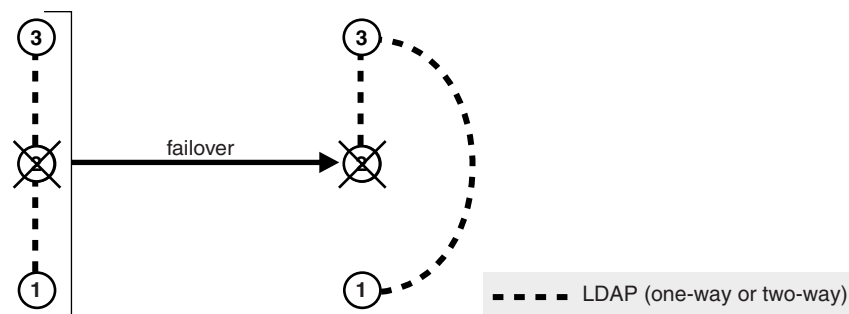

- The consumer is connected to the old supplier with an LDAP-based agreement and the old supplier is in the same Advanced Replication group as the new supplier. This is shown in [Figure 39-3](#). Node 2 and Node 3 are in the same Advanced Replication DRG. Node 2 is the original supplier for Node 4. When Node 4 fails, you can fail over Node 4 to a new supplier, Node 3.

Figure 39-3 Old and New Suppliers in the Same Advanced Replication Group

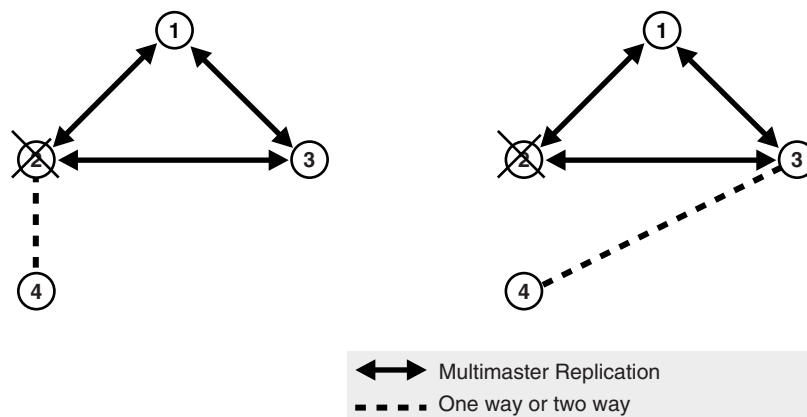

Limitations and Warnings for Replication Failover

This section describes limitations and warnings related to the use of replication failover.

- As of Oracle Internet Directory 11g Release 1 (11.1.1), replication failover requires administrator intervention.
- Following failover, you must compare and reconcile the consumer with the new supplier.
- The new agreement must be of the same type and direction as the old agreement.
- Only two topology types are supported.
- When a supplier fails, its directly connected replica can only fail over to another directly connected replica of the failed supplier.
- The replication filtering policy for the agreement between the new supplier and old supplier must match that between the old supplier and consumer.
- In most cases, you should fail over the replica in a way that preserves the original replica type. In the case shown in [Figure 39-4](#), node 2 is the old supplier for both node 1 and 3, and node 1 is read-only. When node 2 fails, you could, in theory, set up either node 1 or 3 as the new supplier node. Best practice, however, is to fail over node 1 so that node 3 is the supplier. This preserves node 1's original, read-only replica type.

Figure 39-4 Failover Preserving Replica Type

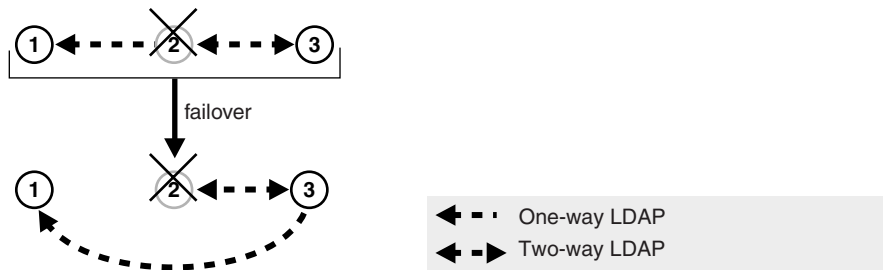

- If the new agreement is a two-way agreement, after you compare and reconcile the consumer with its new supplier, you must also compare and reconcile all other replicas that are connected to the new supplier with the new supplier. For example, in [Figure 39-5](#), Node 2 has a two-way agreement with Node 3. Node 3 is connected to another replica, Node 4. When Node 2 fails, you set up a two-way agreement between node 3 and node 1. After comparing and reconciling node 3 with node 1, you must also compare and reconcile Node 4 with node 3 to ensure that the replicas are synchronized.

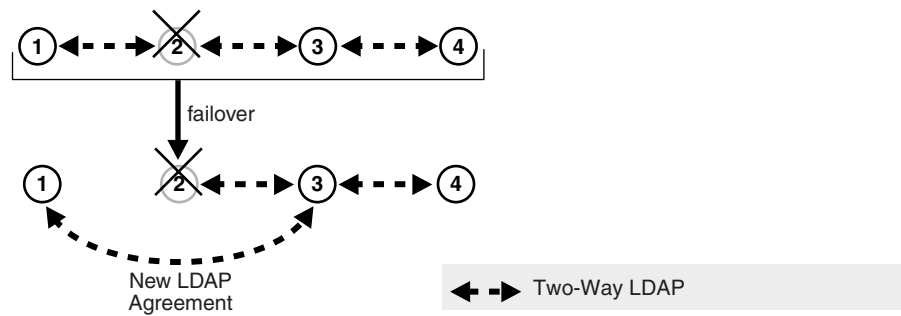
Figure 39-5 Compare and Reconcile All Connected Replicas

Determining Which Type of Replication Failover to Use

There are two types of replication failover. They are:

- Stateless
- Time-based

Use stateless failover when you are unable to plan for the failover in advance. Stateless replication failover makes no assumptions about the state of the replicas. You can fail over to a new supplier at any time. Stateless failover requires more work after failover to synchronize the nodes.

Use time-based failover for planned failover. Time-based failover results in less work after failover. However, it requires some setup ahead of time to ensure that the following assumptions are true at the time of failover:

- The nodes are mostly synchronized
- The new supplier has preserved its change logs so that complete synchronization can be achieved quickly.

Performing a Stateless Replication Failover

This section explains how to perform a stateless replication failover. It consists of the following tasks:

- [Task 1: Stop all Directory Replication Server on related Nodes](#)
- [Task 2: Break Old Replication Agreement and Set up New Agreement](#)
- [Task 3: Save Last Change Number](#)
- [Task 4: Compare and Reconcile New Supplier and Consumer](#)
- [Task 5: Update Last Applied Change Number of New Agreement](#)
- [Task 6: Clean Up Old Agreement on Old Supplier](#)
- [Task 7: Start All Directory Replication Server on related Nodes](#)

Task 1: Stop all Directory Replication Server on related Nodes

Stop the Oracle directory replication servers on the new supplier, old supplier and consumer, by typing:

```
oidctl connect=connStr server=oidrepld instance=1 componentname=oidComponentName \
  flags="-h LdapHost -p LdapPort" stop
```

Task 2: Break Old Replication Agreement and Set up New Agreement

Break the old replication agreement between the old supplier and consumer and set up a new agreement between the new supplier and consumer. Do this by using the Replication Environment Management Tool. Type:

```
remtool -pchgmaster [-v] [-bind consumer_host::port_number]
```

you are prompted for the *replication_dn_password*.

See Also: The `remtool` command-line tool reference in *Oracle Fusion Middleware Reference for Oracle Identity Management*

Task 3: Save Last Change Number

Obtain the last change number from the new supplier.

For a one-way agreement, use the following command:

```
ldapsearch -h new_supplier_host -p port_number -b "" \  
-s base "objectclass=*" lastchangenumber
```

For a two-way agreement, use the following command:

```
ldapsearch -h consumer_host -p port_number -b "" \  
-s base "objectclass=*" lastchangenumber
```

Save this number!

Task 4: Compare and Reconcile New Supplier and Consumer

Use the Oracle Internet Directory Comparison and Reconciliation Tool to compare and reconcile the new supplier and consumer. For a one-way agreement, type:

```
oidcmprec operation=reconcile \  
source=new_supplier_host:port \  
destination=consumer_host:port \  
base="" scope=sub
```

For a two-way agreement, type:

```
oidcmprec operation=merge \  
source=new_supplier_host:port\  
destination=consumer_host:port/ \  
base="" scope=sub
```

you are prompted for the source and destination replication dn passwords.

This example assumes that the entire directory is replicated and, therefore, that `base` is set to `" "`. If you are using partial replication, use the `base` and `dns2exclude` arguments to the `oidcmprec` tool to include the desired DIT.

See Also: The `oidcmprec` command-line tool reference in *Oracle Fusion Middleware Reference for Oracle Identity Management*

Task 5: Update Last Applied Change Number of New Agreement

Modify the new agreement with the retrieved last applied number at the new supplier. To do this:

1. Create an LDIF file with the last change number you retrieved in "[Task 3: Save Last Change Number](#)".

For a one-way agreement, it should look similar to this:

```
dn: agreement_dn
changetype: modify
replace: orclLastAppliedChangeNumber;apply$new_supplier_host$consumer_host
orclLastAppliedChangeNumber;apply$new_supplier_host$consumer_host:
last_change_number_retrieved.
-
replace: orclLastAppliedChangeNumber;transport$new_supplier_host$consumer_host
orclLastAppliedChangeNumber;transport$new_supplier_host$consumer_host:
last_change_number_retrieved_from_new_supplier
```

For a two-way agreement, it should look similar to this:

```
dn: agreement_dn
changetype: modify
replace: orclLastAppliedChangeNumber;apply$new_supplier_host$consumer_host
orclLastAppliedChangeNumber;apply$new_supplier_host$consumer_host:
last_change_number_retrieved_from_new_supplier
-
replace: orclLastAppliedChangeNumber;transport$new_supplier$consumer
orclLastAppliedChangeNumber;transport$new_supplier$consumer:
last_change_number_retrieved_from_new_supplier
-
replace: orclLastAppliedChangeNumber;apply$consumer_host$new_supplier_host
orclLastAppliedChangeNumber;apply$consumer_host$new_supplier_host:
last_change_number_retrieved_from_consumer
-
replace: orclLastAppliedChangeNumber;transport$consumer_host$new_supplier_host
orclLastAppliedChangeNumber;transport$consumer_host$new_supplier_host:
last_change_number_retrieved_from_consumer
```

2. Modify the agreement by using `ldapmodify`, as follows:

```
ldapmodify -D "cn=orcladmin" -q -h host_name -p port_number -f LDIF_file
```

Task 6: Clean Up Old Agreement on Old Supplier

If the old supplier was down when you performed "[Task 2: Break Old Replication Agreement and Set up New Agreement](#)", the old agreement on the old supplier was not cleaned up. Clean it up now by using the Replication Environment Management Tool. Type:

```
remtool -pcleanup -agrmt [-v] [-bind consumer_host::port_number]
```

you are prompted for the `replication_dn_password`.

See Also: The `remtool` command-line tool reference in *Oracle Fusion Middleware Reference for Oracle Identity Management*

Task 7: Start All Directory Replication Server on related Nodes

Start the Oracle directory replication servers on the new supplier, the old supplier and the consumer, by typing:

```
oidctl connect=connStr server=oidrepld instance=1 \
name=instance_name componentname=component_name \
flags="-h LdapHost -p LdapPort" start
```

See Also: [Chapter 4, "Understanding Process Control of Oracle Internet Directory Components"](#)

Performing a Time-Based Replication Failover

This section explains how to perform a time-based replication failover. It contains these topics:

- [Task 1: Configure Change Log Garbage Collection Object on New Supplier](#)
- [Task 2: Save Last Change Number from New Supplier](#)
- [Task 3: Enable Change Log Regeneration on New Supplier](#)
- [Task 4: Wait for the Desired Time Period to Elapse](#)
- [Task 5: Stop all Directory Replication Servers on Related Nodes](#)
- [Task 6: Break Old Replication Agreement and Set Up New Agreement](#)
- [Task 7: Update Last Applied Change Number of New Agreement](#)
- [Task 8: Clean Up Old Agreement on Old Supplier](#)
- [Task 9: Start All Directory Replication Servers on Related Nodes](#)

Task 1: Configure Change Log Garbage Collection Object on New Supplier

Configure the changelog purging configuration entry on the new supplier so that it preserves change logs for the desired period, for example, 24 hours, as follows:

1. Create an LDIF file similar to this:

```
dn: cn=changelog purgeconfig,cn=purgeconfig,cn=subconfigsubentry
changetype:modify
replace: orclpurgetargetage
orclpurgetargetage: 24
```

2. Apply the LDIF file by typing:

```
ldapmodify -D "cn=orcladmin" -q -p port -h host -D dn -f LDIF_file
```

See Also: [Chapter 35, "Managing Garbage Collection"](#)

Task 2: Save Last Change Number from New Supplier

Obtain the last change number from the new supplier, as follows:

```
ldapsearch -h new_supplier_host -p port_number -D cn=orcladmin -q \
  -b "" -s base "objectclass=*" lastchangenumber
```

Save this number!

Task 3: Enable Change Log Regeneration on New Supplier

Enable change log regeneration at the new supplier, as follows:

1. Create an LDIF file like this:

```
dn:
changetype: modify
replace: orclldiprepository
orclldiprepository: TRUE
```

2. Apply the LDIF file by typing:

```
ldapmodify -D "cn=orcladmin" -q -h host_name -p port_number -f LDIF_file
```

Task 4: Wait for the Desired Time Period to Elapse

Wait for a period no greater than the value of `orclpurgetargetage` in the `changelog` purging configuration entry.

Task 5: Stop all Directory Replication Servers on Related Nodes

Stop the Oracle directory replication servers on the new supplier, old supplier and consumer, by typing:

```
oidctl connect=connStr server=oidrepld instance=1 \  
componentname=oidComponentName \  
flags="-h LdapHost -p LdapPort" stop
```

See Also: [Chapter 4, "Understanding Process Control of Oracle Internet Directory Components"](#)

Task 6: Break Old Replication Agreement and Set Up New Agreement

Break the old replication agreement between the old supplier and the consumer, then set up a new agreement between the new supplier and the consumer. Do this by using the Replication Environment Management Tool, as follows:

```
remtool -pchmaster [-v] [-bind hostname:port_number]
```

you are prompted for the `replication_dn_password`.

See Also: The `remtool` command-line tool reference in *Oracle Fusion Middleware Reference for Oracle Identity Management*

Task 7: Update Last Applied Change Number of New Agreement

Modify the new agreement at the new supplier so that its last applied change number has the value you retrieved in "[Task 2: Save Last Change Number from New Supplier](#)", as follows:

1. Create an LDIF file with the retrieved last applied change number, similar to this:

```
dn: agreement_dn  
changetype: modify  
replace: orclLastAppliedChangeNumber  
orclLastAppliedChangeNumber: last_change_number_retrieved
```

2. Apply the LDIF file to the agreement by using `ldapmodify`:

```
ldapmodify -D "cn=orcladmin" -q -h host_name -p port_number -f LDIF_file
```

Task 8: Clean Up Old Agreement on Old Supplier

If the old supplier was down when you performed "[Task 6: Break Old Replication Agreement and Set Up New Agreement](#)", the old agreement on the old supplier was not cleaned up. Clean it up now by using the Replication Environment Management Tool. Type:

```
remtool -pcleanup -agrmt [-v] [-bind hostname:port_number]
```

you are prompted for the *replication_dn_password*.

See Also: The `remtool` command-line tool reference in *Oracle Fusion Middleware Reference for Oracle Identity Management*

Task 9: Start All Directory Replication Servers on Related Nodes

Start the Oracle directory replication servers on the new supplier, the old supplier and the consumer, by typing:

```
oidctl connect=connStr server=oidrepld instance=1 \  
componentname=oidComponentName \  
flags="-h LdapHost -p LdapPort" start
```

See Also:

- [Chapter 4, "Understanding Process Control of Oracle Internet Directory Components"](#)
- The `oidctl` command-line tool reference in *Oracle Fusion Middleware Reference for Oracle Identity Management*.

Managing Replication Configuration Attributes

This chapter describes configuration attributes that control the Oracle Internet Directory replication server. The attributes reside in specific containers in the DIT.

See [Chapter 41, "Managing and Monitoring Replication"](#) for specific replication management tasks.

This chapter contains the following sections:

- [Introduction to Replication Configuration Attributes](#)
- [Configuring Replication Configuration Attributes by Using Fusion Middleware Control](#)
- [Managing Replication Configuration Attributes From the Command Line](#)

Introduction to Replication Configuration Attributes

This introduction contains the following topics:

- [The Replication Configuration Container](#)
- [The Replica Subentry](#)
- [The Replication Agreement Entry](#)
- [The Replication Naming Context Container Entry](#)
- [The Replication Naming Context Object Entry](#)
- [The Replication Configuration Set](#)
- [Examples of Replication Configuration Objects in the Directory](#)

The Replication Configuration Container

All replication information for a node resides in the container `cn=replication configuration` located at the root DSE. This entry resides on each node in a DRG. The following is a sample replication configuration container entry:

```
dn: cn=replication configuration
orclaci: access to entry by * (browse)
orclaci: access to attr=(*) by * (search,read)
orclnormdn: cn=replication configuration
cn: replication configuration
description: Replication agreement Container object
objectclass: top
objectclass: orclcontainerOC
```

The Replica Subentry

The Replica subentry has the DN

```
orclreplicaid=Replica_ID,cn=replication configuration
```

This subentry is created at installation under the replication configuration container. It contains attributes that identify and define the characteristics of the node it represents.

[Table 40–1](#) describes the attributes of the replica subentry. Under Update Mechanism, EM indicates that you can manage this attribute with Oracle Enterprise Manager Fusion Middleware Control. LDAP indicates that you can manage this attribute by using LDAP tools.

Table 40–1 Attributes of the Replica Subentry

Attribute	Description	Update Mechanism	Default	Possible Values
orclreplicaid	Unique identifier for directory database. Initialized at installation. Matches orclreplicaid at the root DSE.	Read-only	<i>hostname_</i> <i>ORACLESID</i>	Integer
orclreplicauri	Address used to open a connection to this replica.	EM, LDAP		Valid ldapURI format
orclreplicasecondaryuri	Addresses used if orclReplicaURI cannot be used.	EM, LDAP		Valid ldapURI format
orclreplicatype	Defines the type of replica such as read-only or read/write.	EM, LDAP	0 (Read/Write)	0: Read/Write 1: Read-Only 2: Pilot
orclpilotmode	Defines whether replica is in pilot (testing) mode.	remtool -pilotreplica	0	0: False 1: True
orclreplicastate	Defines state of the replica.	EM, LDAP		You can set 0, 1, 2, 6, or 8. Server sets other values. See Table D–1 on page D-6.
pilotstarttime	Time when replica entered pilot (testing) mode.	Read-only		Time

Note: On Windows systems, ensure that the replication server is not running before you enable bootstrapping by changing the value of orclReplicaState to 0.

In [Figure 40–3](#) on page 40-12, a replica subentry is represented by orclReplicaID=*UID_of_node_D*,cn=replication configuration.

The following is a sample replica subentry:

```
dn: orclreplicaid=myhost1_repl1,cn=replication configuration
objectclass: top
objectclass: orclreplicasubentry
orclreplicaid: myhost1_repl1
```



```

orclreplicauri: ldap://myhost1:3060/
orclreplicasecondaryuri: ldap://myhost1.mycompany.com:3060/
orclreplicastate: 1

```

See Also: ""Replication Schema Elements" in *Oracle Fusion Middleware Reference for Oracle Identity Management* for descriptions of the attributes of the replica subentry.

The Replication Agreement Entry

The DN of the Replication Agreement Entry is:

```
orclagreementid=Agreement_ID,orclreplicaid=Replica_ID,cn=replication configuration
```

This entry contains attributes that define the replication agreement between the two or more nodes and is associated with the `orclReplAgreementEntry` objectclass. There are two kinds of agreement:

1. Oracle Database Advanced Replication-based replication agreement. The replication agreement for Advanced Replication nodes resides under the replication configuration set. For example: In [Figure 40–2](#), an Oracle Database Advanced Replication-based replication agreement entry is represented by `orclagreementID=000001,cn=replication configuration`.
2. LDAP-based replication agreement. The replication agreement for LDAP nodes resides under the supplier's replica subentry. For example, in [Figure 40–3](#), an LDAP-based replication agreement entry is represented by `orclagreementID=000003, orclReplicaID=UID_of_node_D,cn=replication configuration`.

Replication Agreement Entry Attributes

[Table 40–2](#) shows the attributes in the replication agreement. Under Update Mechanism, EM indicates that you can manage this attribute with Oracle Enterprise Manager Fusion Middleware Control. LDAP indicates that you can manage this attribute by using LDAP tools.

Table 40–2 Attributes of the Replication Agreement Entry

Attribute	Description	Update Mechanism	Default	Possible Values
<code>orclagreementid</code>	Name of replication agreement entry.	Read-only		
<code>orclreplicadn</code>	LDAP-based replication only. DN of the replica to identify a consumer in the replication agreement.	Read-only		DN
<code>orclreplicationprotocol</code>	Replication protocol for change propagation to replica. Values:	Read-only		ODS_ASR_1.0: Oracle Database Advanced Replication-based ODS_LDAP_1.0: LDAP-based
<code>orcldirreplgroupsas</code>	For Oracle Database Advanced Replication-based groups only. <code>Orclreplicaid</code> values of all the nodes in this replication group. This list must be identical on all nodes in the group. You can modify this attribute.	LDAP		

Table 40–2 (Cont.) Attributes of the Replication Agreement Entry

Attribute	Description	Update Mechanism	Default	Possible Values
orclupdateschedule	Update interval for new changes and those being retried.	EM, LDAP	60 (seconds)	Greater than or = 0
orclhighschedule	Interval at which the directory replication server repeats the change application process.	EM, LDAP	600 (seconds)	Greater than or = 60 (seconds)
orclldapconnectionkeepalive	Whether the connections from replication server to the directory server are kept active or established every time the changelog processing is done.	EM, LDAP	1	0: false 1: true
orcllastappliedchangenumber	<p>Last change number transported or applied at the consumer replica. For LDAP-based agreements, this attribute contains subtypes. The format is:</p> <p><code>orcllastappliedchangenumber; status_type\$supplier_replicaID\$consumer_replicaID: Number</code></p> <p>where <i>status_type</i> is: <i>transport</i> or <i>apply</i>, <i>supplier_replicaID</i> and <i>consumer_replicaID</i> indicate the direction of LDAP data flow, and <i>Number</i> is the last applied change number.</p> <p>It indicates that changelogs from <i>supplier_replicaID</i> to <i>consumer_replicaID</i> with change number less than <i>Number</i> have been transported/applied at node <i>consumer_replicaID</i>.</p> <p>For Oracle Database Advanced Replication-based agreements, only the base type is used.</p>	Read-only		
orclexcludingcontexts	<p>Subtrees to be excluded from replication.</p> <p>Applicable only to Oracle Database Advanced Replication-based agreements. LDAP replication uses the Replication Naming Context Entry, described, in Table 40–3.</p>	Read-only		
orclreplicationid	Unique identifier of a one-way, two-way, or peer-to-peer replication group	Read-only		
orclagreementtype	Replication agreement type.	Read-only		0: one-way/read-only fan-out replication agreement 1: two-way/updatable fan-out replication agreement 2: LDAP-based multimaster replication agreement 3: Oracle Database Advanced Replication-based multimaster replication agreement

Oracle Database Advanced Replication-Based Replication Agreements

For Advanced Replication, the replication agreement on each node lists all of the nodes in the group. It is identical on each node except for local options such as partitioned naming contexts on the local directory server.

The entry for this kind of replication agreement resides immediately below the `cn=replication configuration` container entry. For example, the DN of such an agreement can look like this: `orclagreementID=000001, cn=replication configuration`.

LDAP Replication Agreements

For LDAP-based replication, there are separate replication agreements for each supplier-consumer relationship. For one-way replication, there is a single, one-way replication agreement.

The entry for an LDAP-based replication agreement resides immediately below the replica subentry of the node that serves as the supplier. Thus, the DN of the replication agreement as found on a supplier node is:

```
orclagreementID=unique_identifier_of_the_replication_agreement,
orclReplicaID=unique_identifier_of_supplier_node, cn=replication
configuration
```

Similarly, the DN of the replication agreement as found on a consumer node is:

```
orclagreementID=unique_identifier_of_the_replication_agreement,
orclReplicaID=unique_identifier_of_supplier_node, cn=replication
configuration
```

In a fan-out replication agreement, you can tell which node the agreement entry is associated with by looking at its parent. For example, look at the following replication agreement entry.

```
orclagreementID=000002, orclReplicaID=node_A, cn=replication
configuration
```

In this example, you can determine that the replication agreement represented by `orclagreementID=000002` is associated with node A. This is because the parent of `orclagreementID=000002` is `orclReplicaID=node_A`.

Notes:

- The container entry `cn=replication configuration` is replicated on all nodes, but may not be identical on all nodes.
 - The `orclreplicadn` attribute of an LDAP-based replication agreement specifies the associated consumer node.
 - The `agreementtype` indicates the replication agreement type. See [Table 40-2, "Attributes of the Replication Agreement Entry"](#) for values of `orclagreementtype`.
-
-

Two-Way LDAP Replication Agreements

For two-way replication, there can be either a single, two-way replication agreement or two one-way agreements for each supplier-consumer relationship. The following is a sample two-way replication agreement entry:

```
dn: orclagreementid=000002, orclreplicaid=stadd58_repl, cn=replication
configuration
```

```
orclagreementid: 000002
orclreplicationprotocol: ODS_LDAP_1.0
orclreplicadn: orclreplicaid=stadd57_repl,cn=replication configuration
orclldapconnkeepalive: 1
orclagreementtype: 1
orclreplicationid: 000002
orcllastappliedchangenumber;transport$stadd57$stadd58: 106
orcllastappliedchangenumber;transport$stadd58$stadd57: 2421
orcllastappliedchangenumber;apply$stadd57$stadd58: 106
orcllastappliedchangenumber;apply$stadd58$stadd57: 2421
orclupdateschedule: 0
orclhiqschedule: 60
objectclass: orclReplAgreementEntry
objectclass: top
```

Note: The value of `orclagreementtype` is 1 because this is a two-way replication agreement. See [Table 40-2, "Attributes of the Replication Agreement Entry"](#) for values of `orclagreementtype` for other replication agreement types.

See Also: "Replication Schema Elements" in *Oracle Fusion Middleware Reference for Oracle Identity Management* for descriptions of the attributes of the replication agreement entry

The Replication Naming Context Container Entry

This entry contains all the LDAP naming context objects.

This entry has the RDN `cn=replication namecontext`, and it is created below the `orclagreementID` entry during replication configuration. The following is a sample replication naming context container entry:

```
dn: cn=replication namecontext,orclagreementid=000002,
   orclreplicaid=myhost1_repl1,cn=replication configuration
objectclass: top
objectclass: orclcontainerOC
cn: replication namecontext
```

The Replication Naming Context Object Entry

This entry contains all the LDAP naming context objects. These objects specify the replication filtering policy, that is, what to include in or exclude from replication to an LDAP-based partial replica.

Note: You cannot include naming contexts or exclude attributes in Oracle Database Advanced Replication-based agreements. Advanced Replication agreements use the base attribute `orclincludednamingcontexts` described in [Table 40-2](#).

This entry is created below the naming context container entry during replication configuration. It is configurable. For example, in [Figure 40-3](#) on page 40-12, the replication naming context object is:

```
cn=includednamingcontext000001,cn=replication
```

namecontext, orclagreementID=000003, orclReplicaID=UID_of_node_D, cn=replication configuration.

Table 40-3 describes the attributes of the replication naming context entry. If you use the Replication Wizard in Oracle Enterprise Manager Fusion Middleware Control to set up replication, you set these on the Scope page.

Table 40-3 Attributes of the Replication Naming Context Entry

Attribute	Description
orclincludednamingcontexts	<p>The root of the naming context to be replicated. If orclincludednamingcontexts is set to "*", all the naming contexts are replicated. This attribute has subtypes that specify the replication direction in which the naming context should be included. The format is:</p> <pre>orclincludednamingcontexts ; supplier_replicaID\$consumer_replicaID: DN</pre> <p>This is a single valued attribute. For each naming context object, you can specify only one unique subtree in each direction.</p> <p>In partial replication, except for subtrees listed in the orclxcludednamingcontexts attribute, all subtrees in the specified included naming context are replicated.</p> <p>You can modify this attribute.</p>
orclxcludednamingcontexts	<p>The root of a subtree, located within the included naming context, to be excluded from replication. This attribute has subtypes that specify the replication direction in which the naming context should be excluded. The format is:</p> <pre>orclxcludednamingcontexts; supplier_replicaID\$consumer_replicaID : DN</pre> <p>This is a multivalued attribute. From within the naming context specified in the orclincludednamingcontexts attribute, you can specify one or more subtrees to be excluded from the partial replication in each direction.</p> <p>You can modify this attribute.</p>
orclxcludedattributes	<p>An attribute, located within the included naming context, to be excluded from replication. Orclxcludedattributes has subtypes that specify the replication direction in which the specified attribute should be excluded. The format is:</p> <pre>orclxcludedattributes; supplier_replicaID\$consumer_replicaID: attribute_name</pre> <p>This is a multivalued attribute.</p> <p>You can modify this attribute</p>

The following is a sample replication naming context object entry:

```
dn:cn=namectx001,
cn=replication namecontext,
orclagreementid=unique_identifier_of_the_replication_agreement,
orclreplicaID=replica_id_of_node_A,
cn=replication configuration
orclincludednamingcontexts: cn=mycompany
orclxcludednamingcontexts; replica_id_of_node_A$ replica_id_of_node_B :
c=us, cn=mycompany
orclxcludedattributes; replica_id_of_node_B$ replica_id_of_node_A : userPassword
```

The example specifies the following replication filtering:

- The naming context `cn=mycompany` is included for replication in both directions for node A and node B.
- The naming context `c=us, cn=mycompany` is excluded for replication from node A to node B only.
- The `userPassword` attribute is excluded for replication from node B to node A

See Also:

- ["Examples of LDAP Replication Filtering"](#) on page 38-8
- "Replication Schema Elements" in *Oracle Fusion Middleware Reference for Oracle Identity Management*

The Replication Configuration Set

The replication configuration set has the DN:

```
cn=configset0,cn=osdrep1d,cn=subconfigsubentry
```

[Table 40–4](#) lists and describes the attributes of the replication configuration set, which has the following DN:

```
cn=configset0,cn=osdrep1d,cn=subconfigsubentry
```

You must restart the replication server in order for any attribute changes under this DN to take effect, except for the attribute `orcldebuglevel`. Under Update Mechanism, EM indicates that you can manage this attribute with Oracle Enterprise Manager Fusion Middleware Control. LDAP indicates that you can manage this attribute by using LDAP tools.

Table 40–4 Replication Configuration Set Attributes

Attribute	Description	Update Mechanism	Default	Possible Values
<code>modifyTimestamp</code>	Time of entry creation or modification.	Read-only		
<code>modifiersName</code>	Name of person creating or modifying the entry	Read-only		
<code>orclChangeRetryCount</code>	Number of processing retry attempts for a change-entry before being moved to the human intervention queue.	EM, LDAP	10	Greater than or equal to 1.
<code>orclThreadsPerSupplier;transport</code>	Number of worker threads spawned at each supplier for transporting change logs.	EM, LDAP	1	1-100
<code>orclThreadsPerSupplier;apply</code>	Number of worker threads spawned at each supplier for applying change logs.	EM, LDAP	5	1-100
<code>orclreplautotune</code>	Dynamically vary the number of threads assigned to transport and apply tasks based on load. If you set the server to auto tune, you must specify the number of maximum number of threads to be shared between these tasks. Restart server after changing.	EM, LDAP	1	0: Off 1: On

Table 40–4 (Cont.) Replication Configuration Set Attributes

Attribute	Description	Update Mechanism	Default	Possible Values
orclreplmaxworkers	Maximum number of worker threads. Required if orclreplautotune is set.	EM, LDAP	20	1-100
orclsdumpflag	Generate stack dump. (Restart after changing.)	EM, LDAP	0	0: False 1: True
orclmaxlogfilesize	Maximum log file size (MB)	EM, LDAP	1 MB	> or = 1
orclmaxlogfiles	Maximum number of log files to keep in rotation	EM, LDAP	100	> or = 1
orclsizelimit	Maximum number of entries to process per replication cycle	EM, LDAP	1000	1-10000
orclconflresolution	Automatically resolve replication conflicts	EM, LDAP	1	0: False 1: True
orclreplusesasl;digest-md5	Use SASL for replication binds.	EM, LDAP	Attribute does not exist by default.	auth, auth-int, auth-conf
orclActivateReplication	Specifies that replication be activated on the replication server designated by orclOidInstanceName and orclOidComponentName.	EM, LDAP	0	0: False 1: True
orclReplicationState	Activation state of the replication server	Read-only, using EM, LDAP	0	0 or nonexistent: Not running False 1: Running
orcldebuglevel	Debug level of replication server	EM, LDAP	0	Values are additive: 0: No Debug Log 2097152: Replication Performance Log 4194304: Replication Debug Log 8388608: Function Call Trace 16777216: Heavy Trace Log
orclOidComponentName	Name of OID component where replication is or will be activated	Read-only	Set during replication setup	String
orclOidInstanceName	Instance number of instance where replication is or will be activated	Read-only	Set during replication setup	Integer
orclReplAttrConflict	Specifies whether timestamp or attribute version should be honored first during attribute level conflict resolution.	EM, LDAP	0	0: Timestamp first. 1: Version number first

Examples of Replication Configuration Objects in the Directory

The examples of replication objects in this section rely on the replication environment shown in [Figure 40–1](#).

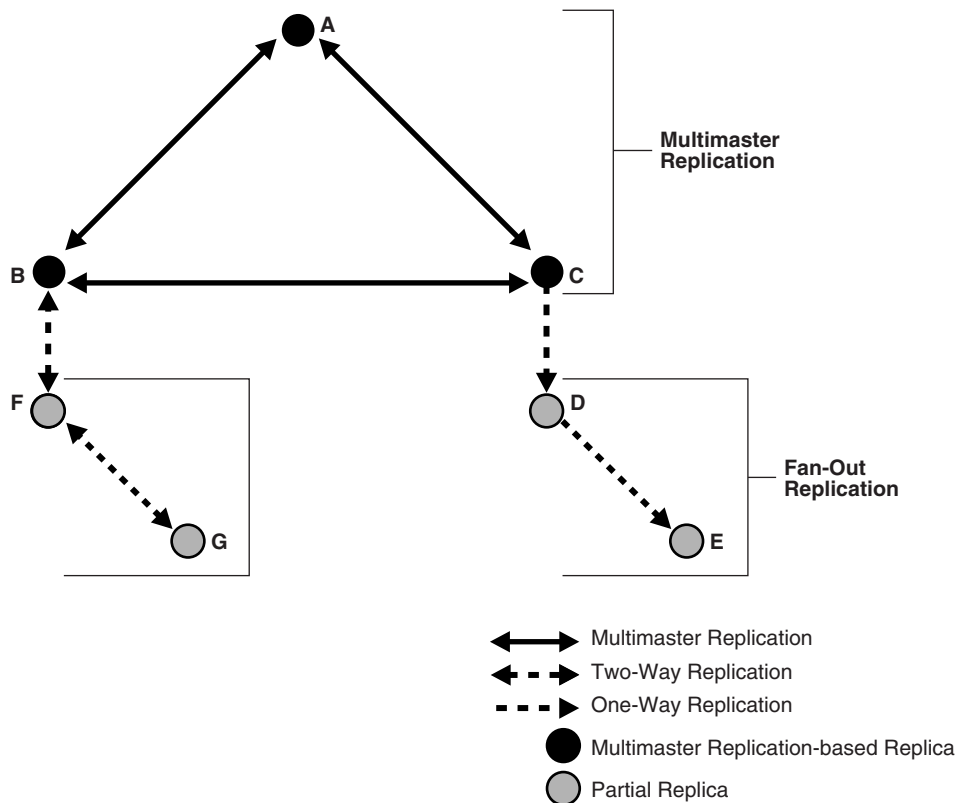
Figure 40–1 Example: Multimaster Replication and Fan-Out Replication

In [Figure 40–1](#), nodes A, B, and C form a multimaster replication group. Node C replicates to a fourth node, D, which, in turn, fans out to Node E.

The replication agreements in this environment are as follows:

- Node A has one replication agreement representing its multimaster relationship with nodes B and C.
- Node B has two replication agreements, the first representing its multimaster relationship with nodes A and C, the second representing its relationship to node F. The replication agreement between B and F is two-way.
- Node C has two replication agreements, the first representing its multimaster relationship with nodes A and B, the second representing its relationship to node D. This is a one-way replication agreement in which C serves as the supplier and node D is the consumer.
- Node D has two replication agreements. Both of its replication agreements are one-way. One represents its relationship to the supplier node C, from which it consumes changes, the other represents its relationship to consumer node E for which it is the supplier.
- Node E has a one-way replication agreement with Node D. Node E is the consumer.
- Node F has two replication agreements, one representing its relationship to the node B, the other representing its relationship to node G. Both are two-way replication agreements.
- Node G has a one-way replication agreement with Node F. Node G is the consumer.

Figure 40–2 shows the replication objects in the DIT that pertain to node C in Figure 40–1 on page 40-10.

Figure 40–2 Example: Replication Configuration Entries for Node C

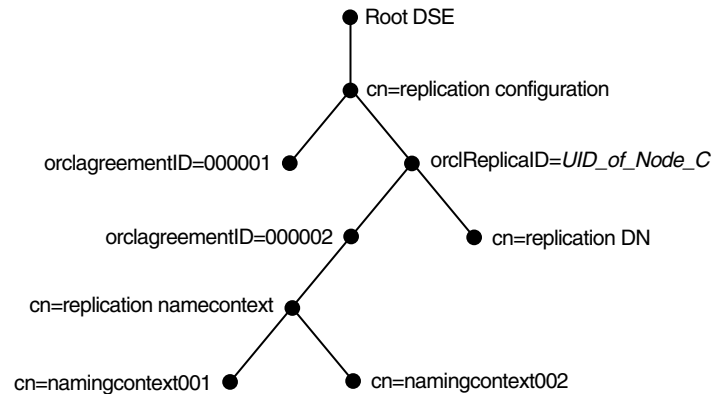

For node C, the entry `cn=replication configuration` at the root DSE contains these RDNs:

- `orclagreementID=000001`: The multimaster replication agreement in which node C participates with nodes A and B.
- `orclReplicaID=UID_of_node_C`: Unique identifier of node C that contains information about it.
- `orclagreementID=000002`: Unique identifier of the relationship between supplier node C and consumer node D. You know that, in this case, `orclagreementID=000002` is the replication agreement of the supplier node C because node C is its parent.

This entry contains the attribute `orclreplicaDN`. Its value is the replica entry DN of consumer node D, with which node C has the replication agreement.

- `cn=replication DN`: The bind DN that the directory replication server on node C uses to bind to the directory server.
- `cn=replication namecontext`: Container of information about naming contexts that are included in replication.
- `cn=includednamingcontext000001` and `cn=namingcontext002`: The actual objects that are included in or excluded from replication. In the naming context included for replication, you can specify one or more subtrees to be excluded from replication. In that same included naming context, you can specify particular attributes to be excluded from replication.

Figure 40–3 shows the replication agreement entry in the DIT that pertains to node D in Figure 40–1 on page 40-10.

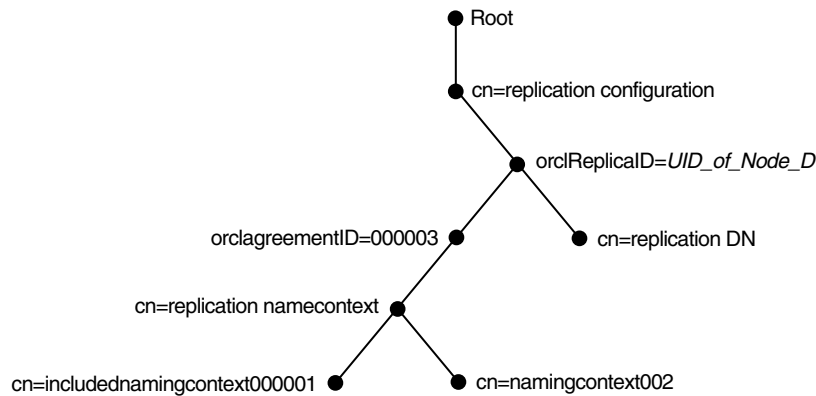
Figure 40–3 Example: Replication Configuration Entries for Node D

For node D, the entry `cn=replication configuration` at the root DSE contains these RDNs:

- `orclReplicaID=UID_of_node_D`: Unique identifier of node D and contains information about it.
- `orclagreementID=000003`: Unique identifier of the relationship between supplier node D and consumer node E. You know that, in this case, `orclagreementID=000003` is the replication agreement of the supplier node D because node D is its parent.

This entry contains the attribute `orclreplicaDN`, the value of which is the DN of consumer node E with which node D has the replication agreement.

- `cn=replication DN`: Bind DN that the directory replication server on node D uses to bind to the directory server.
- `cn=replication namecontext`: Container of information about naming contexts that are included in replication.
- `cn=includednamingcontext001` and `cn=namingcontext002`: Objects specifying naming contexts to be included in replication. In the naming context included in replication, you can specify one or more subtrees or particular attributes to be excluded from replication.

Configuring Replication Configuration Attributes by Using Fusion Middleware Control

This section provides a summary of the replication configuration attributes that correspond with fields you can configure by using Oracle Enterprise Manager Fusion Middleware Control. For more specific procedures, see [Chapter 41, "Managing and Monitoring Replication."](#)

Configuring Attributes on the Shared Properties, Replication Tab

You can configure some of the replication attributes by using the Oracle Internet Directory **Shared Properties** page of Fusion Middleware Control. Select **Administration**, then **Shared Properties**, then select **Replication** from the **Oracle Internet Directory** menu. After changing the configuration, choose **Apply**. The correspondence is as follows:

Table 40–5 Configuration Attributes on Shared Properties, Replication Tab

Field or Heading	Configuration Attribute
Change Retry Count	orclchangeretrycount
Maximum Number of Workers	orclreplmaxworkers
Autotune Replication	orclreplautotune
Number of Apply Threads Per Supplier	orclthreadspersupplier;apply
Number of Transport Threads per Supplier	orclthreadspersupplier;transport
Maximum Number of Entries to Process per Replication Cycle	orclsizelimit
Automatically Resolve Replication Conflicts	orclconflresolution
Generate Stack Dump	orclsdumpflag
SASL for Replication Bind	orclreplusesasl;digest-md5
Maximum Log File Size (MB)	orclmaxlogfilesize
Maximum number of log files to keep in rotation	orclmaxlogfiles
Conflict resolution for modify operations	orclreplattrconflict
DebugLevel	orcldebuglevel
Replication Status	orclreplicationstate
Activate/Inactivate	orclactivatereplication
Replica ID	orclreplicaid
Replica Primary URI	orclreplicauri
Replica Secondary URI	orclreplicasecondaryuri
Replica State	orclreplicastate
Replica Type	orclreplicatype

Configuring Replication Wizard Parameters

Some of the values you select or enter in the Oracle Enterprise Manager Fusion Middleware Control replication wizard control specific configuration attributes. For example, your selections on the Schedule page of the replication wizard control the attributes listed in [Replication Schedule Attributes Table 40–6](#).

Table 40–6 Replication Schedule Attributes

Field or Heading	Configuration Attribute
LDAP Connection	orclldapconnkeepalive
Replication Frequency	orclupdateschedule
HIQ Schedule	orclhiqshecule

The wizard sets other attributes appropriately when you configure replication. For example, the attribute `orclreplicauri` is formed by concatenation of the fields on the Replicas page of the wizard.

Managing Replication Configuration Attributes From the Command Line

You can modify most attributes from the command line by using `ldapmodify`. The command line syntax is:

```
ldapmodify -D cn=orcladmin -q -p portNum -h hostname -f ldifFile
```

The contents of the LDIF file depends on the DN and the operation being performed.

For examples of LDIF files for changing replication configuration attributes, see ["Managing and Monitoring Replication by Using the Command Line"](#) on page 41-14.

Managing and Monitoring Replication

This chapter tells you how to monitor and manage replication in Oracle Internet Directory. For more information about replication configuration attributes, see [Chapter 40, "Managing Replication Configuration Attributes."](#)

This chapter contains the following sections:

- [Introduction to Managing and Monitoring Replication](#)
- [Managing and Monitoring Replication by Using ODSM and Fusion Middleware Control](#)
- [Managing and Monitoring Replication by Using the Command Line](#)
- [Comparing and Reconciling Inconsistent Data by Using oidcmprec](#)

Note: Some changes do not take effect until the replication server is restarted.

Introduction to Managing and Monitoring Replication

After you have installed and configured replication, you can view or modify the default values for replication-related attributes. The attributes and their containers are described in [Chapter 40, "Managing Replication Configuration Attributes."](#)

See Also:

- [Chapter 6, "Understanding Oracle Internet Directory Replication"](#)
- [Chapter 38, "Setting Up Replication"](#)
- [Appendix C, "Setting Up Oracle Database Advanced Replication-Based Replication"](#)
- [Appendix D, "How Replication Works"](#)

This introduction includes the following topics:

- [Managing Worker Threads](#)
- [Change Logs in Directory Replication](#)
- [The Human Intervention Queue](#)
- [Pilot Mode](#)
- [Conflict Resolution in Oracle Replication](#)

Modifying What Is to Be Replicated in LDAP-Based Partial Replication

In LDAP-based partial replication, you can change what is or is not replicated by modifying replica naming context objects. The parameters for these objects are stored in entries that have this DN:

```
cn=namingcontext_ID,cn=replication namecontext,
orclAgreementID=numeric_identifier_of_replication_agreement,
orclReplicaId=unique_identifier_of_replica, cn=replication configuration
```

Note: Because the directory replication server reads replica naming context objects from the agreement located at the supplier, you must apply all modifications against naming context objects at the supplier and, optionally, at the consumer.

See ["Viewing and Modifying Replica Naming Context Objects"](#) on page 41-8 and ["Modifying Replica Naming Context Object Parameters by Using ldapmodify"](#) on page 41-18.

Managing Worker Threads

The replication server is a multithreaded process. You can control the number of worker threads per supplier that are dedicated to:

- Transporting the changelogs from supplier to consumer
- Applying the transported changelogs at consumer

You can set the number of transport threads and the number of apply threads per supplier. Alternatively, you can configure the replication server to auto tune, that is, to dynamically vary the number of threads assigned to these two tasks based on load. If you set the server to auto tune, you must specify the number of maximum number of threads to be shared between these tasks.

[Table 41–1](#) shows the Oracle Enterprise Manager Fusion Middleware Control parameters and configuration attributes that control worker threads. These are attributes of the replication configuration set.

Table 41–1 Configuration Attributes Controlling Worker Threads

Fusion Middleware Control Parameter	Configuration Attribute
Maximum Number of Workers	orclreplmaxworkers
Autotune Replication	orclreplautotune
Number of Apply Threads Per Supplier	orclthreadspersupplier;apply
Number of Transport Threads per Supplier	orclthreadspersupplier;transport

You must tune these numbers based on load. In Oracle Enterprise Manager Fusion Middleware Control, you configure threads by using the Shared Properties page, Replication tab. From the command line, you use `ldapmodify`.

See Also:

- ["Configure Replication Attributes by Using Fusion Middleware Control"](#) on page 41-11
- ["Configuring Attributes of the Replication Configuration Set by Using ldapmodify"](#) on page 41-21
- [Table 40-4, "Replication Configuration Set Attributes"](#) on page 40-8

Change Logs in Directory Replication

Oracle Internet Directory records each change as an entry in the change log store. Each entry has a unique change number. The consumer keeps track of the change number of the last change it applied, and it retrieves from the supplier only those changes with numbers greater than that of the last change it applied.

- In an LDAP-based replication agreement, change log processing consists of two phases, transporting the change log and applying the change log. For each LDAP-based agreement, there are two change log processing statuses, one for the each phase. The directory replication server stores the last change number it transported in the `transport` subtype of the `orlcllastappliedchangenumber` attribute of the replication agreement entry. The directory replication server stores the last change number it applied in the `apply` subtype of the `orlcllastappliedchangenumber` attribute of the replication agreement entry. The format of the `orlcllastappliedchangenumber` attribute is shown in [Table 40-2, "Attributes of the Replication Agreement Entry"](#) on page 41-5.
- In a replication agreement based on Oracle Database Advanced Replication, the directory replication server stores the last change number it transported in the `changenumber` attribute of the `changestatus` entry. The `changenumber` attribute looks like this:

```
changenumber=last_applied_change_number, supplier=supplier_node,
consumer=consumer_node
```

For example, if the last change a consumer applied had a number of 250, then subsequent changes it retrieves from that supplier would need to have numbers greater than 250.

Change logs are purged by the garbage collector after they have been consumed by the replication server.

The Human Intervention Queue

["The Replication Process"](#) on page D-8 describes the roles of the human intervention queue, the purge queue, and the retry queue in replication. ["Conflict Resolution in Oracle Replication"](#) on page 41-4 provides information about the role of these queues in conflict resolution.

Managing the Queues

The human intervention queue tools, `ManageHiq.retry` and `ManageHiq.purge`, enable you to move changes from the human intervention queue to the retry queue or the purge queue, respectively. See ["Managing the Human Intervention Queue"](#) on page 41-24.

Queue Statistics

You can view queue statistics by using the replication wizard in Oracle Enterprise Manager Fusion Middleware Control or the command line. See "[Viewing Queue Statistics by Using Fusion Middleware Control](#)" on page 41-13 and "[Viewing Change Logs by Using ldapsearch](#)" on page 41-15.

The Number of Entries the Human Intervention Queue Tools Can Process

If the number of entries in the Human Intervention Queue is greater than the maximum number of changelogs the replication server can process at a time, some entries are never processed.

The maximum number of changelogs the replication server can process at a time is the minimum of two configuration attributes:

- `orclsize` in the replication configuration set
- `orclsize` in the instance-specific configuration entry of the OID component where replication is active

The default value of `orclsize` in the replication configuration set is 1000. If you set it to 0, it takes the default value of 1000.

The `orclsize` attribute in the Oracle Internet Directory instance-specific entry specifies the maximum number of entries to be returned by a search. (Its default value is 10000.)

To increase the number of changelogs processed at a time, you must set both attributes to the same value, a value greater than 1000.

See Also:

- "[Managing the Number of Entries the Human Intervention Queue Tools Can Process](#)" on page 41-25
- [Table 40-4, "Replication Configuration Set Attributes"](#) on page 40-8

Setting the Oracle Internet Directory server instance parameter `orclsize` very high impacts server performance, because `orclsize` in the Oracle Internet Directory server instance also controls the maximum number of entries to be returned by a search.

Pilot Mode

Pilot mode is used to test an application before deploying it in production. Typically, you set pilot mode on the local node, with one-way replication from the production node. While the replica is in pilot mode, all the LDAP changes occurring at the local node are tracked. When you end pilot mode, those changes are written to an LDIF file. When the application is deployed in production, all the entries added or modified in the pilot replica can be added to the production node using the ldif file.

See Also: "[Specifying Pilot Mode for a Replica by Using remtool](#)" on page 41-17

Conflict Resolution in Oracle Replication

Oracle Database Advanced Replication-based replication and two-way and multimaster LDAP-based replication enable updates to multiple directory servers.

Conflicts occur whenever the directory replication server attempts to apply remote changes from a supplier to a consumer and, for some reason, fails.

Conflicts usually stem from differences in the timing of changes arising from the occasional slowness or transmission failure over wide area networks. Also, an earlier inconsistency might continue to cause conflicts if it is not resolved in a timely manner.

In partial replication, when a naming context is changed from included to excluded, the replication server deletes the naming context at the consumer. Similarly, if the naming context is changed from excluded to included, the replication server synchronizes the entire naming context from supplier to consumer.

LDAP operations that can lead to conflicts include:

- Addition
- Deletion
- Modification
- Modification of either an RDN or a DN

Levels at Which Replication Conflicts Occur

There are two types of conflicts:

- Entry-level conflicts
- Attribute-level conflicts

Table 41–2 Types of Replication Conflict

Level of Replication Conflict	Description
Entry-level conflicts	<p>Caused when the directory replication server attempts to apply a change to the consumer. One of the following types of changes to the consumer could occur:</p> <ul style="list-style-type: none"> ■ Adding an entry that already exists ■ Deleting an entry that does not exist ■ Modifying an entry that does not exist ■ Applying a modifyrdn operation when the DN does not exist <p>These conflicts can be difficult to resolve. For instance, it may be impossible to resolve a conflict because:</p> <ul style="list-style-type: none"> ■ The entry has been moved to a different location ■ The entry has not yet arrived from a supplier ■ The entry has been deleted ■ The entry never existed on the consumer <p>If an entry exists and it should not, then it may be because it was added earlier, or that it recently underwent a modifydn operation.</p>
Attribute-level conflicts	<p>Caused when two directories are updating the same attribute with different values at different times. If the attribute is single-valued, then the replication process resolves the conflict by examining the timestamps of the changes involved in the conflict and the attribute version number. The attribute <code>orclReplAttrConf1</code> in the replication configuration set entry determines which is honored first. If <code>orclReplAttrConf1</code> is 0 (the default) timestamp is honored first. If it is 1, attribute version is honored first.</p>

Automatic Conflict Resolution

In 11g Release 1 (11.1.1), you can enable automatic conflict resolution. When this feature is enabled, conflicts in the Human Intervention Queue are automatically moved to the purge queue if the supplier's schema and consumer's schema match.

You can use either Oracle Enterprise Manager Fusion Middleware Control or the `ldapmodify` command to enable or disable automatic conflict resolution. To use Oracle Enterprise Manager Fusion Middleware Control, change the replication configuration parameter **Automatically Resolve Replication Conflicts**, on the Replication tab of the Shared Properties page. To use the command line, change the value of `orclconflresolution` in the replication configuration set.

See Also:

- ["Replication Configuration Set Attributes"](#) on page 40-8
- ["Configure Replication Attributes by Using Fusion Middleware Control"](#) on page 41-11
- ["Configuring Attributes of the Replication Configuration Set by Using ldapmodify"](#) on page 41-21

How Automated Conflict Resolution Works

The directory replication server attempts to resolve all conflicts that it encounters by following this process:

1. The conflict is detected when a change is applied.
2. The replication process attempts to reapply the change a specific number of times or repetitively for a specific amount of time after a specific waiting period.
3. If the replication process reaches the retry limit without successfully applying the change, it flags the change as a conflict, which it then tries to resolve. If the conflict cannot be resolved according to the resolution rules (described in the next section), the change is moved to a low-priority, human intervention queue. Changes are then applied according to the time unit specified in the `orclHIQSchedule` parameter in the replication agreement. Before it moves the change, the directory replication server writes the conflict into a log file for the system administrator.

Note: There is no conflict resolution of schema, catalog, and group entries during replication. This is because attempting resolution of such large multivalued attributes would have a significant negative impact on performance. Be careful to avoid updating such entries from more than one master at a time.

See Also:

- [Appendix D, "How Replication Works"](#) for descriptions of how the multimaster replication process adds, deletes, and modifies entries, and how it modifies DNs and RDNs.
- "Oracle Identity Management LDAP Schema Reference" in *Oracle Fusion Middleware Reference for Oracle Identity Management* for schema questions
- The `catalog` command-line tool reference in *Oracle Fusion Middleware Reference for Oracle Identity Management* for catalog questions
- The section on managing group entries in *Oracle Identity Management Guide to Delegated Administration* in the 10g (10.1.4.0.1) library for group entry questions

Managing and Monitoring Replication by Using ODSM and Fusion Middleware Control

You can manage and monitor replication by using Oracle Enterprise Manager Fusion Middleware Control. This section contains the following topics:

- [Enabling or Disabling Change Log Generation by Using Fusion Middleware Control](#)
- [Viewing the Local Change Logs by Using Oracle Directory Services Manager](#)
- [Viewing and Modifying Replica Naming Context Objects](#)
- [Viewing or Modifying a Replication Setup by Using the Replication Wizard](#)
- [Deleting an LDAP-Based Replication Agreement by Using the Replication Wizard](#)
- [Configure Replication Attributes by Using Fusion Middleware Control](#)
- [Activating or Inactivating a Replication Server by Using Fusion Middleware Control](#)
- [Configuring the Replication Debug Level by Using Fusion Middleware Control](#)
- [Configuring Replica Details by Using Fusion Middleware Control](#)
- [Viewing Queue Statistics by Using Fusion Middleware Control](#)
- [Managing Changelog Processing by Using Fusion Middleware Control](#)
- [Monitoring Conflict Resolution Messages by Using Fusion Middleware Control](#)

Enabling or Disabling Change Log Generation by Using Fusion Middleware Control

You can enable and disable change log generation by using Oracle Enterprise Manager Fusion Middleware Control, as follows:

1. Choose **Administration**, then **Server Properties** from the **Oracle Internet Directory** menu.
2. Choose the **Performance** tab.
3. Select or deselect **Enable Change Log Generation**.
4. After changing the configuration, choose **Apply**.

Viewing the Local Change Logs by Using Oracle Directory Services Manager

Oracle Directory Services Manager enables you to view the last 500 changes you performed, listing them by change log number, the type of operation—namely, add, modify, or delete—in which each occurred, and the entry on which each was made. It allows you select a particular change to see more specific details about it.

You can view change logs by using Oracle Directory Services Manager, as follows:

1. From the task selection bar, select **Advanced**.
2. Expand **Change Log** if it is not already expanded. The left panel lists the last 500 changes, beginning with the most recent.
3. Select a change to view its properties.

[Table 41-3](#) lists the properties shown on the Change Log page and the corresponding attributes of the change log entry.

Table 41-3 Properties on the Change Log Page

Property	Change Log Attribute
Change Number	changenum
Operation	changetype
TargetDN	targetdn
Changes	changes
Global Unique Identifier (GUID)	orclguid
Parent GUID	orclparentguid
Change Retry Count	orclchangeretrycount
Modifier's Name	modifiersname
Operation Time	operationtime
Server Name	servername

Viewing and Modifying Replica Naming Context Objects

To add, delete, view, and modify parameters for replica naming context objects, use the Replication Wizard in Oracle Enterprise Manager Fusion Middleware Control:

1. From the Oracle Internet Directory menu on the home page, select **Administration**, then **Replication Management**.
2. You are prompted to log into the replication DN account. Provide the host, port, replication DN, and replication DN password.
3. The **Replication Agreements** page lists information about each replication agreement: name, type, supplier, consumer, and status. Select the name of the replication agreement you want to edit and click the **Edit** icon. Three tabs appear at the bottom of the screen.
4. On the **Scope** tab, you can change the scope settings.

To add a primary naming context, click the **Create** button above the Primary Naming Context field.

To change the primary naming context, click the **Edit** button above the Primary Naming Context field and select a different container.

5. To exclude a secondary naming context, select it in the **Secondary Naming Contexts** field and click **Exclude** to move it to the **Excluded Secondary Naming Contexts** field.

To include a secondary naming context, select it in the Excluded Secondary Naming Contexts field and click **Include** to move it to the **Secondary Naming Contexts** field.

6. To exclude an attribute, select it in the **Attributes** field and click **Exclude** to move it to the Excluded Attributes field.

To include an attribute, select it in the Excluded Attributes field and click **Include** to move it to the **Attributes** field.

7. To apply your changes, click **Apply**.

8. To effect the changes you have made, you must start or restart the replication server. For one-way replication, you must restart it on the consumer. For a two-way or multimaster replication agreement, you must restart the replication server on each of the nodes in the replication agreement. To do this, select the Oracle Internet Directory node in the navigation tree and select **Control** from the Oracle Internet Directory menu.

Viewing or Modifying a Replication Setup by Using the Replication Wizard

When you set up replication, you create a replication agreement and replica subentry. You can view or modify the setup by using the Replication Wizard in Oracle Enterprise Manager Fusion Middleware Control, as follows.

1. From the Oracle Internet Directory menu on the home page, select **Administration**, then **Replication Management**.
2. You are prompted to log into the replication DN account. Provide the host, port, replication DN, and replication DN password.
3. To view queue statistics for a replication agreement, select the replication agreement, select **Queue Statistics** and proceed as described in "[Viewing Queue Statistics by Using Fusion Middleware Control](#)" on page 41-13.
4. To view or edit a replication agreement, select the name of the replication agreement you want to edit and click the **Edit** icon. At the bottom of the screen, three tabs appear.
5. To view or edit the replication configuration, select the **Replication Configuration** tab.

Note: Always inactivate replication before you delete or modify a replication agreement. See "[Activating or Inactivating a Replication Server by Using Fusion Middleware Control](#)" on page 41-11.

- a. In the LDAP Connection field, select **Keep Alive** if you want the replication server to use same connection for performing multiple LDAP operations. Select **Always Use New Connection** if you want the server to open a new connection for each LDAP operation.
- b. Enter the **Replication Frequency**.
- c. Enter the Human Intervention Queue Schedule. This is the interval, in seconds, at which the directory replication server repeats the change application process.

- d. Click **Apply** to apply your changes, or click **Cancel** to discard your changes.
6. To view or change the Scope settings, click the **Scope** tab. Proceed as described in ["Viewing and Modifying Replica Naming Context Objects"](#) on page 41-8.
7. To view the type, host, port, and user name for each node, click the **Replicas** tab of the Edit Replication Definition page.
8. To view or edit Replica Primary URI, Replica Secondary URI, or Replica State for a node:
 - a. Select the **Replicas** tab and click the "+" next to the supplier or consumer.
 - b. Make desired changes to the **Replica Primary URI** or **Replica Secondary URI** fields.
 - c. Select a **Replica State** from the list.
 - d. Click **Apply** to apply your changes, or click **Cancel** to discard your changes.
9. To make a node the primary node in a multimaster replication group:
 1. Click the **Replicas** tab, select the node, and
 2. Click the **Make Primary Node** icon.
 3. Click **Apply** to add the node to the existing directory replication group or click **Cancel** to discard your changes.
10. To add a node to a multimaster replication group:
 - a. Select the **Replicas** tab.
 - b. Click the **Create** icon.
 - c. In the popup window, provide the host, port and replication DN password details for the new node. Click **Add**.
 - d. Click **Apply** to add the node to the existing directory replication group or click **Cancel** to discard your changes.
11. To delete a node from a multimaster replication group containing three or more nodes:
 - a. Select the **Replicas** tab.
 - b. Click the replica you want to delete from the multimaster replication deployment. The **Delete** icon becomes enabled.
 - c. Click **Delete**.
 - d. Click **Apply** to delete the node from the directory replication group (DRG)

Deleting an LDAP-Based Replication Agreement by Using the Replication Wizard

You delete a one-way, two-way, or multimaster LDAP replica by using the Replication Wizard in Oracle Enterprise Manager Fusion Middleware Control.

Note: Always inactivate replication before you delete or modify a replication agreement. See ["Activating or Inactivating a Replication Server by Using Fusion Middleware Control"](#) on page 41-11.

1. From the Oracle Internet Directory menu on the home page, select **Administration**, then **Replication Management**. The Replication Agreements

page lists information about each replication agreement: name, type, supplier, consumer, and status.

2. You are prompted to log into the replication DN account. Provide the host, port, replication DN, and replication DN password.
3. To delete a replication agreement, select the agreement and click the **Delete** icon. When the Delete Popup appears, click **Delete**.

Configure Replication Attributes by Using Fusion Middleware Control

You can configure most replication configuration set attributes by using the Replication tab of the **Shared Properties** page of Fusion Middleware Control. Select **Administration**, then **Shared Properties** from the **Oracle Internet Directory** menu, then select **Replication**. After changing the configuration, choose **Apply**. [Table 41–4](#) shows the correspondence between the fields on the Replication Configset section of the Shared Properties page. See [Table 40–5](#) on page 40-13 for detailed information about these attributes.

Table 41–4 *Replication Configset Attributes on Shared Properties, Replication Tab*

Field or Heading	Configuration Attribute
Change Retry Count	orclchangeretrycount
Maximum Number of Workers	orclreplmaxworkers
Autotune Replication	orclreplautotune
Number of Apply Threads Per Supplier	orclthreadspersupplier;apply
Number of Transport Threads per Supplier	orclthreadspersupplier;transport
Entries to Process per Replication Cycle	orclsize-limit
Automatically Resolve Replication Conflicts	orclconflresolution
Generate Stack Dump	orclsdumpflag
SASL for Replication Bind	orclreplusesasl;digest-md5
Maximum Log File Size (MB)	orclmaxlogfilesize
Maximum number of log files to keep in rotation	orclmaxlogfiles
DebugLevel	orcldebuglevel

Restart the server after changing Autotune Replication or Generate Stack Dump.

See Also:

- [Table 40–4, "Replication Configuration Set Attributes"](#) on page 40-8 for a description of the attributes.
- ["Configuring the Replication Debug Level by Using Fusion Middleware Control"](#) on page 41-12 for more information on setting Debug Level.

Activating or Inactivating a Replication Server by Using Fusion Middleware Control

When you set up replication using the Replication Wizard, the replication server is automatically activated on the Oracle Internet Directory instances where you configured it. If necessary, you can inactivate replication and activate it again without changing your configuration. You can also inactivate replication on one instance and activate it on another Oracle Internet Directory instance that is sharing the same

database. To disable or enable replication by using Oracle Enterprise Manager Fusion Middleware Control, use the Replication Server Status section of the Replication tab of the **Shared Properties** page of Fusion Middleware Control

Configure the attributes as follows:

1. Select **Administration**, then **Shared Properties** from the **Oracle Internet Directory** menu, then select **Replication**.
2. In the Replication Server Status section of the page, select the Oracle Internet Directory component that you want to activate or inactivate from the **Activate Replication on** list. This list displays all the Oracle Internet Directory components in a WebLogic Server domain that share the same database.
3. If the replication status of the selected Oracle Internet Directory component is inactive, you can click **Activate** to activate it. If the replication status is active, you can click **Inactivate** to deactivate it. You do not need to click anything else. Activating replication on one instance automatically inactivates it on the instance where it was previously active.

Note: The Revert and Apply buttons at the top of the page have no effect upon the replication server status.

Table 41–5 shows the correspondence between the fields in the Replication Server Status section of the page and the configuration attributes. See Table 40–4, "Replication Configuration Set Attributes" on page 40-8 for more information about these attributes.

Table 41–5 Replication Server Status Attributes on Shared Properties, Replication Tab

Field or Heading	Configuration Attribute
Replication Status	orclreplicationstate
Activate Replication on	orclactivatereplication

Configuring the Replication Debug Level by Using Fusion Middleware Control

You can configure the replication debug level by using the Debug Level section of the Replication tab of the **Shared Properties** page of Fusion Middleware Control.

See Table 40–4, "Replication Configuration Set Attributes" on page 40-8 for information about the `orcldebuglevel` attribute.

Configure the debug level as follows:

1. Select **Administration**, then **Shared Properties** from the **Oracle Internet Directory** menu, then select **Replication**.
2. Select any combination of Replication Process, Trace Function Calls, Replication Performance Log, and Heavy Trace Debugging.
3. Choose **Apply**.

Configuring Replica Details by Using Fusion Middleware Control

You can change replica details by using the Replica Details section of the **Replication** tab of the **Shared Properties** page of Fusion Middleware Control.

Table 41–6 shows the correspondence between the fields in the Replica Details section and the attributes of the replica subentry. See Table 40–1, "Attributes of the Replica Subentry" on page 40-2 for more information about these attributes.

See "LDAP Replica States" on page D-5 for information about the values of `orclreplicastate`.

Table 41–6 Replica Details on Shared Properties, Replication Tab

Field or Heading	Configuration Attribute in the Replica Subentry
Replica ID	<code>orclreplicaid</code>
Replica Primary URI	<code>orclreplicauri</code>
Replica Secondary URI	<code>orclreplicasecondaryuri</code>
Replica State	<code>orclreplicastate</code>
Replica Type	<code>orclreplicatype</code>

To configure the replica details, select **Administration**, then **Shared Properties** from the **Oracle Internet Directory** menu, then select **Replication**. After changing the configuration, choose **Apply**.

The choices for Replica State are Bootstrap, Online and DB Copy AddNode.

The choices for Replica Type are ReadWrite, Read Only, and Pilot.

Viewing Queue Statistics by Using Fusion Middleware Control

You view statistics for an LDAP replica by using the Oracle Enterprise Manager Fusion Middleware Control replication wizard, as follows.

1. From the Oracle Internet Directory menu on the home page, select **Administration**, then **Replication Management**.
2. You are prompted to log into the replication DN account. Provide the host, port, replication DN, and replication DN password.
3. The **Replication Agreements** page lists information about each replication agreement. Click the name of the replication agreement for which you want to view the queue statistics, then click the **Queue Statistics** icon.
4. The bottom of the page lists the following statistics:
 - New Changes
 - Retry Changes
 - Purge Changes
 - HIQ Changes
 - Last Applied Change
 - Last Transported Change

Managing Changelog Processing by Using Fusion Middleware Control

To increase the number of changelogs processed at a time, you must set `orclszelimit` in the replication configuration set and `orclszelimit` in the server instance where replication is running to the same value, a value greater than 1000.

To change `orclsizeLimit` in the replication configuration set by using Fusion Middleware Control:

1. Select **Administration**, then **Shared Properties** from the **Oracle Internet Directory** menu
2. Select **Replication**.
3. Change the parameter **Maximum Number of Entries to Process per Replication Cycle**.
4. Choose **Apply**.

To change `orclsizeLimit` in a server instance by using Oracle Enterprise Manager Fusion Middleware Control:

1. Select **Administration**, then **Server Properties** from the **Oracle Internet Directory** menu.
2. Select **General**.
3. Change the value of **Maximum number of entries to be returned by a search**.
4. Choose **Apply**.

Setting the Oracle Internet Directory server instance parameter `orclsizeLimit` very high impacts server performance, because `orclsizeLimit` also controls the maximum number of entries to be returned by a search.

See Also: [Table 40–4, "Replication Configuration Set Attributes"](#) on page 40-8.

Monitoring Conflict Resolution Messages by Using Fusion Middleware Control

You can view conflict resolution messages in the Replication Log by using Oracle Enterprise Manager Fusion Middleware Control, as follows:

1. From the Oracle Internet Directory menu, select **Monitoring**, then **Logs**. The Log Messages page appears.
2. Click **Log Files**. The Log Files page appears.
3. Select **Replication Log**.

See Also:

- ["Viewing Log Files by Using Fusion Middleware Control"](#) on page 23-5 for detailed information about viewing log files in Oracle Enterprise Manager Fusion Middleware Control.
- ["Monitoring Conflict Resolution Messages by Using the Command Line"](#) on page 41-22 for detailed information about conflict resolution messages.

Managing and Monitoring Replication by Using the Command Line

This section contains the following topics

- [Enabling and Disabling Change Log Generation by Using the Command Line](#)
- [Viewing Change Logs by Using `ldapsearch`](#)
- [Configuring Attributes of the Replica Subentry by Using `ldapmodify`](#)
- [Specifying Pilot Mode for a Replica by Using `remtool`](#)

- [Configuring Replication Agreement Attributes by Using ldapmodify](#)
- [Modifying Replica Naming Context Object Parameters by Using ldapmodify](#)
- [Configuring Attributes of the Replication Configuration Set by Using ldapmodify](#)
- [Monitoring Conflict Resolution Messages by Using the Command Line](#)
- [Managing the Human Intervention Queue](#)
- [Viewing Queue Statistics and Verifying Replication by Using remtool](#)
- [Managing the Number of Entries the Human Intervention Queue Tools Can Process](#)
- [Changing the Replication Administrator's Password for Advanced Replication](#)

Enabling and Disabling Change Log Generation by Using the Command Line

You can enable and disable change log generation by using `ldapmodify` to change the value of `orclgeneratechangelog`, which is an instance-specific attribute. You enable change log generation by setting the value to 1 and disable it by setting the value to 0. The command is:

```
ldapmodify -D cn=orcladmin -q -p portNum -h hostname -f ldifFile
```

The LDIF file for changing the value of the `orclgeneratechangelog` attribute in the instance-specific entry to 1 looks like this:

```
dn: cn=componentname,cn=osldlapd,cn=subconfigsentry
changetype: modify
replace: orclgeneratechangelog
orclgeneratechangelog: 1
```

Viewing Change Logs by Using ldapsearch

To view change logs from the command line, you use `ldapsearch`. Specify in the search filter the change number or range of change numbers of the change logs you want to view. If you want to view change logs that have been transported from a supplier to the local host, also specify the replica ID of the supplier in the search filter.

For example, to view a range of change logs that have been transported from the supplier to the local node, type:

```
ldapsearch -D cn=orcladmin -p port -q -b "cn=changelogs" -s one \
  "(&(objectclass=changeLogEntry)(servername=SUPPLIER_REPLICAID)\
  (changeNumber>=FROMCHGNO)(changeNumber<=TOCHGNO))"
```

To view a single change log that has been transported from the supplier to the local node, type:

```
ldapsearch -D cn=orcladmin -p port -q -b "cn=changelogs" -s one \
  "(&(objectclass=changeLogEntry)(servername=SUPPLIER_REPLICAID)\
  (changeNumber=CHGNO))"
```

To view a range change logs that have been generated at the local node, type:

```
ldapsearch -D cn=orcladmin -p port -q -b "cn=changelogs" -s one \
  "(&(objectclass=changeLogEntry)(changeNumber>=FROMCHGNO)(changeNumber<=TOCHGNO))"
```

To view a single change log that has been generated at the local node, type:

```
ldapsearch -D cn=orcladmin -p port -q -b "cn=changelogs" -s one \
```

```
" (&(objectclass=changeLogEntry) (changeNumber=CHGNO) ) "
```

Some lines in the output might contain the string <@ ! !@> as a separator.

Table 41-7 lists the important attributes in the change log.

Table 41-7 Important Attributes in the Change Log

Attribute	Description
changenumber	Change Number
changetype	Operation
targetdn	Target DN
changes	Changes
orclguid	Global Unique Identifier (GUID)
orclparentguid	Parent GUID
orclchangeretrycount	Change Retry Count
modifiersname	Modifier's Name
operationtime	Operation Time
servername	Server Name

Configuring Attributes of the Replica Subentry by Using ldapmodify

The replica subentry has the DN

```
orclreplicaid=Replica_ID,cn=replication configuration
```

Table 41-8 lists the attributes of the replica subentry that you can modify with ldapmodify. The command line syntax is:

```
ldapmodify -D cn=orcladmin -q -p portNum -h hostname -f ldifFile
```

Table 41-8 Replica Subentry Attributes

Description	Configuration Attribute
Replica ID	orclreplicaid
Replica Primary URI	orclreplicauri
Replica Secondary URI	orclreplicasecondaryuri
Replica State	orclreplicastate
Replica Type	orclreplicatype

See Also:

- [Table 40-1, "Attributes of the Replica Subentry"](#) on page 40-2
- ["LDAP Replica States"](#) on page D-5

Table D-1, "LDAP Replica States" describes the values of orclreplicastate in detail. You can set 0, 1 the values, 2, 6, or 8. The other orclreplicastate values listed in Table D-1 are read-only values set by the replication server during bootstrap.

To set orclreplicastate to zero, you would use the following LDIF file:

```
dn: orclreplicaid=Replica_ID,cn=replication configuration
```

```
changetype: modify
replace: orclreplicastate
orclreplicastate: 0
```

Specifying Pilot Mode for a Replica by Using remtool

Before you deploy a replica as part of your enterprise, you might want to test it in pilot mode. You use the `remtool` command to begin and end pilot mode. The syntax is:

```
remtool -pilotreplica begin -bind hostname:ldap_port
```

```
remtool -pilotreplica end -bind hostname:ldap_port [-bkup file_name]
```

When you run `remtool -pilotreplica begin`:

- `orclreplicatype` is set to 2 (pilot)
- `orclpilotmode` is set to 1
- `pilotstarttime` is set to current time.

When you run `remtool -pilotreplica end`

- `orclpilotmode` is set to 0

Do not attempt to modify these attributes directly with `ldapmodify`.

See Also: The `remtool` command reference in *Oracle Fusion Middleware Reference for Oracle Identity Management* for more information about the `-pilotreplica` option to `remtool`.

Configuring Replication Agreement Attributes by Using ldapmodify

The replication agreement has the DN:

```
orclagreementid=Agreement_ID,orclreplicaid=Replica_ID,cn=replication configuration
```

Table 41–9 lists the replication agreement attributes that you can modify by using `ldapmodify`. See Table 40–2, "Attributes of the Replication Agreement Entry" on page 41-5 for more information.

Note: Always inactivate replication before you delete or modify a replication agreement. See "[Activating or Inactivating a Replication Server by Using Fusion Middleware Control](#)" on page 41-11.

Table 41–9 Replication Agreement Options

Description	Configuration Attribute	Default Value
Replication frequency	<code>orclupdateschedule</code>	60 (seconds)
HIQ Schedule	<code>orclhiqschedule</code>	600 (seconds)
Whether the connections from the directory replication server to the directory server are kept active or established every time changelog processing is done	<code>orclldapconnkeepalive</code>	1

The following LDIF file changes the human intervention queue schedule by changing the value of the `orclHIQSchedule` attribute in the replication agreement to 900 minutes:

```
dn: orclagreementid=Agreement_ID,orclreplicaid=Replica_ID,cn=replication
configuration
changetype: modify
replace: orclhiqschedule
orclhiqschedule: 900
```

See Also: [Table 40-2, "Attributes of the Replication Agreement Entry"](#) on page 40-3

Modifying Replica Naming Context Object Parameters by Using `ldapmodify`

It is possible to change the replication scope from the command line. To do so, you must create or modify the naming context object entries under the replication naming context container entry. See

See Also:

- [Table 40-2, "Attributes of the Replication Agreement Entry"](#) on page 40-3
- ["The Replication Naming Context Container Entry"](#) on page 40-6
- ["The Replication Naming Context Object Entry"](#) on page 40-6

To change the replication scope, you would use a command line such as:

```
ldapadd -p port_number -h host -f file.ldif
```

with an LDIF file to set the scope for an agreement.

For example, you would use the following LDIF file to set the replication scope to `cn=oraclecontext`:

```
dn: cn=includednamingcontext000001,cn=replication
namecontext,orclagreementid=agreementid,orclreplicaid=replicaid,cn=replication
configuration
objectclass: orclreplnamectxconfig
orclincludednamingcontexts: cn=oraclecontext
cn: includednamingcontext000001
```

You would use the following file to exclude EMEA and APAC groups and exclude the attributes `userpassword` and `authpassword` from the replication scope

```
dn: cn=includednamingcontext000002,cn=replication
namecontext,orclagreementid=agreementid,orclreplicaid=replicaid,cn=replication
configuration
objectclass=orclreplnamectxconfig
orclincludednamingcontexts: dc=com
orclExcludednamingcontexts: cn=groups,l=emea,dc=xyz,dc=com
orclExcludednamingcontexts: cn=groups,l=apac,dc=xyz,dc=com
orclExcludedAttributes: userpassword
orclExcludedAttributes: authpassword
cn: includednamingcontext000002
```

Replica naming context object parameters are listed and described under Replication Schema Elements in *Oracle Fusion Middleware Reference for Oracle Identity Management*.

Note: The replication server reads naming context objects from the supplier replica.

Example 41–1 Adding a Naming Context Object for an LDAP-Based Replica

This example creates a naming context object that does the following:

- Replicates the naming context `ou=Americas, cn=mycompany`
- Excludes from replication the naming context `cn=customer profile, ou=Americas, cn=mycompany`
- Excludes from replication the attribute `userpassword`

The steps are:

1. Edit the example file `mod.ldif` as follows:

```
dn: cn=naming_context_identifier, cn=replication namecontext,
    orclagreementid=replication_agreement_identifier,
    orclreplicaid=supplier_replica_identifier, cn=replication configuration
orclincludednamingcontexts: ou=Americas, cn=mycompany
orclexcludednamingcontexts: cn=customer profile, ou=Americas, cn=mycompany
orclexcludedattributes: userpassword
objectclass: top
objectclass: orclreplnamectxconfig
```

2. Use `ldapadd` to add the partial replication naming context object to the supplier.

```
ldapadd -D "cn=orcladmin" -q -h supplier_host \
        -p port_number -f mod.ldif
```

Example 41–2 Deleting a Naming Context Object

To delete the naming context object created in [Example 41–1](#), type:

```
ldapdelete -D "cn=orcladmin" -q \
    -h supplier_host -p supplier_host_port_number \
    "cn=naming_context_identifier, cn=replication namecontext, \
    orclagreementid=replication_agreement_identifier, \
    orclreplicaid=supplier_replica_identifier, \
    cn=replication configuration"
```

Example 41–3 Modifying the orclIncludedNamingContexts Attribute for a Replica Naming Context Object

The directory replication server uses the `orclIncludedNamingContexts` attribute value of the replica naming context object to specify the top-level subtree included in partial replication.

In this example, the included naming context is set to `c=us`, which means that `c=us` is to be included in partial replication.

1. Edit the example file `mod.ldif` as follows:

```
DN: cn=naming_context_identifier, cn=replication namecontext,
    orclagreementid=replication_agreement_identifier,
    orclreplicaid=supplier_replica_identifier, cn=replication configuration
Changetype: modify
Replace: orclIncludedNamingContexts
orclIncludedNamingContexts: c=us
```

2. Use `ldapmodify` to update the replication agreement `orclupdateschedule` attribute.

```
ldapmodify -D "cn=orcladmin" -q -h supplier_host -p port -f mod.ldif
```

3. Restart the directory replication server.

Example 41–4 Modifying the `orclExcludedNamingContexts` Attribute for a Replica Naming Context Object

The directory replication server uses the `orclExcludedNamingContexts` attribute value of the replica naming context object to specify the top-level subtrees excluded from partial replication.

In this example, the excluded naming contexts are set to `ou=Europe, c=us` and `ou=Americas, c=us`, which means that these two naming contexts are to be excluded from partial replication.

1. Edit the example file `mod.ldif` as follows:

```
DN:cn=naming_context_identifier,
cn=replication namecontext,
orclagreementid=replication_agreement_identifier,
orclreplicaid=supplier_replica_identifier,cn=replication configuration
Changetype:modify
Replace: orclExcludedNamingContexts
orclExcludedNamingContexts: ou=Europe, c=us
orclExcludedNamingContexts: ou=Americas, c=us
```

2. Use `ldapmodify` to update the replication agreement `orclupdateschedule` attribute.

```
ldapmodify -D "cn=orcladmin" -q -h supplier_host -p port -f mod.ldif
```

3. Restart the directory replication server.

Note: A subtree specified in the `orclExcludedNamingContexts` attribute must also be a subtree of the specified `includedNamingContext` of the same replica naming context object.

Example 41–5 Modifying the `orclExcludedAttributes` Attribute for a Replica Naming Context Object

You can specify that certain changes made to the included naming context be excluded, at attribute level, from partial replication. To determine which attributes are to be excluded, the directory replication server uses the value of the `orclExcludedAttributes` attribute of the replica naming context object.

In this example, the `telephonenumber` and `title` attributes of the naming context specified in the `orclIncludedNamingContexts` attribute are excluded from replication.

1. Edit the example file `mod.ldif` as follows:

```
DN:cn=naming_context_identifier,
cn=replication namecontext,
orclagreementid=replication_agreement_identifier,
orclreplicaid=supplier_replica_identifier,cn=replication configuration
Changetype:modify
Replace: orclExcludedAttributes
orclExcludedAttributes: telephonenumber
orclExcludedAttributes: title
```

2. Use `ldapmodify` to update the replication agreement `orclupdateschedule` attribute.

```
ldapmodify -D "cn=orcladmin" -q -h my_host -p port -f mod.ldif
```
3. Restart the directory replication server.

Configuring Attributes of the Replication Configuration Set by Using `ldapmodify`

The replication configuration set has the DN:

```
cn=configset0,cn=osdrep1d,cn=subconfigsubentry
```

[Table 41–10](#) lists the replication configuration set attributes that you can modify with `ldapmodify`.

Table 41–10 *Replication Configuration Attributes*

Description	Configuration Attribute	Default Value
Change Retry Count	<code>orclchangeretrycount</code>	10
Maximum Number of Workers	<code>orclreplmaxworkers</code>	20
Autotune Replication (Restart server after changing.)	<code>orclreplautotune</code>	1
Number of Apply Threads Per Supplier	<code>orclthreadspersupplier; apply</code>	5
Number of Transport Threads per Supplier	<code>orclthreadspersupplier; transport</code>	1
Maximum Number of Entries to Process per Replication Cycle	<code>orclsizelimit</code>	1000
Automatically Resolve Replication Conflicts	<code>orclconflresolution</code>	1
Generate Stack Dump (Restart server after changing.)	<code>orclsdumpflag</code>	
SASL for Replication Bind	<code>orclreplusesasl;digest-m d5</code>	none
Maximum Log File Size (MB)	<code>orclmaxlogfilesize</code>	1
Maximum number of log files to keep in rotation	<code>orclmaxlogfiles</code>	100
DebugLevel	<code>orcldebuglevel</code>	0
Replication Status	<code>orclreplicationstate</code>	
Activate/Inactivate	<code>orclactivatereplication</code>	0

For example, the following LDIF file enables SASL for replication binds by adding and setting the `orclreplusesasl;digest-md5` attribute in the replication configuration set:

```
dn: cn=configset0,cn=osdrep1d,cn=subconfigsubentry
changetype: modify
add: orclreplusesasl;digest-md5
orclreplusesasl;digest-md5: 1
```

See ["Managing the Number of Entries the Human Intervention Queue Tools Can Process"](#) on page 41-25 for information about changing `orclsizelimit`.

The attribute `orcldebuglevel` can be set to any combination of the values shown in [Table 41–11](#). The values are additive. No restart is required.

Table 41–11 Replication Debug Levels

Debug Level	Value of <code>orcldebuglevel</code>
Replication Process Trace	4194304
Replication Performance Log	2097152
Trace Function Calls	8388608
Heavy Trace Debugging	16777216

See Also: [Table 40–4, "Replication Configuration Set Attributes"](#) on page 40-8.

Monitoring Conflict Resolution Messages by Using the Command Line

If a conflict has been written into the log, then it means that the system is not able to resolve it by following its resolution procedure. To avoid further replication change conflicts arising from earlier unapplied changes, it is important to monitor the logs regularly.

To monitor replication change conflicts, examine the contents of the replication log. You can distinguish between messages by their respective timestamps.

Conflict resolution messages are logged in the file `ORACLE_INSTANCE/diagnostics/logs/OID/componentName/oidrepld00-XXXX.log` where `XXXX` is a number from 0000 to `orclmaxlogfiles` configured.

Each message includes the conflict reason, change number, supplier node, change type, target DN, and result. Here are some examples:

This is a conflict resolution message where the conflict was automatically resolved by replication server:

```
[2008-10-09T09:57:31-07:00] [OID] [NOTIFICATION:16] [] [OIDREPLD] [host: stacu14]
[pid: 4280] [tid: 3] Worker(Transport)::[[***** Conflict Resolution
Message *****
Conflict reason: Attempted to add an existing entry.
Change number: 3696.
Supplier: stacu14_lm5.
Change type: Add.
Target DN: dc=org.
Result: Dropped a newer change entry.
]]
```

This is an unresolved conflict which was moved to Human intervention queue:

```
[2008-10-09T10:03:28-07:00] [OID] [NOTIFICATION:16] [] [OIDREPLD] [host: stacu14]
[pid: 4653] [tid: 13] Worker(Transport)::[[***** Conflict Resolution
Message *****
Conflict reason: Attempted to delete a non-existent entry.
Change number: 3698.
Supplier: stacu14_lm5.
Change type: Delete.
Target DN: dc=imc,dc=org.
Result: Change moved to low priority queue after failing on 10th retry.
]]
```

Conflict reasons, change types, and results include:

Table 41–12 Conflict Resolution Messages

Conflict Reason	Change Type	Result
Attempted to add an existing entry	Add	Dropped a newer change entry. Change moved to low priority queue after failing on Nth retry Deleted duplicated target entry which was created later than the change entry. Apply the change entry again Dropped a newer change entry Dropped change entry since its guid is greater than target entry guid Dropped change entry since its guid is same as target entry i.e change and target entry are identical Deleted duplicated target entry which has greater guid than the change entry
Parent entry does not exist	Add	Change moved to low priority queue after failing on Nth retry
Internal Error occurred	Add Delete Modify moddn	Change moved to low priority queue after failing on Nth retry
Attempted to modify a non-existent entry	Modify	Change moved to low priority queue after failing on Nth retry
Attempted to delete a non-existent entry	Delete	Change moved to low priority queue after failing on Nth retry
Attempted to delete a non leaf entry	Delete	Change moved to low priority queue after failing on Nth retry
Attempted to move a non-existent entry	moddn	Change moved to low priority queue after failing on Nth retry
Attempted to move to an existent entry	moddn	Change moved to low priority queue after failing on Nth retry
Synchronization of moddn for another non-existent entry is going on	moddn	Deleted existent entry which was created later than the entry trying to move. Move of entry is tried again
Attempted to move to an existent entry which is newer than the source entry	moddn	Move of entry is tried again
Attempted to move to an existent entry which is older than the entry trying to move	moddn	Deleted Source entry and dropped the change

Table 41–12 (Cont.) Conflict Resolution Messages

Conflict Reason	Change Type	Result
Attempted to move to an existing entry which was created at the same time and had the same guid	moddn	Deleted Source entry and dropped the change
Attempted to move to an existing entry which has greater guid than the entry trying to move	moddn	Deleted duplicated target entry and re-applied the change
Attempted to move to an existing entry which has lower guid then entry trying to move	moddn	Deleted Source entry and dropped the change

Managing the Human Intervention Queue

When a replication conflict arises, the Oracle Internet Directory replication server places the change in the retry queue and tries to apply it from there for a specified number of times. If it fails after the specified number of retries, the replication server puts the change in the human intervention queue. From there, the replication server repeats the change application process at less frequent intervals while awaiting your action.

The human intervention queue tools, `ManageHiq.retry` and `ManageHiq.purge`, enable you to move changes from the human intervention queue to the retry queue or the purge queue, respectively. After you move the change to the purge queue, there are no further attempts to re-apply the changelog entry. To address changes in the human intervention queue, follow these general steps:

1. Examine the change in the human intervention queue.
2. Reconcile the conflicting changes using the Compare and Reconcile Tool (see ["Comparing and Reconciling Inconsistent Data by Using oidcmprec"](#) on page 41-26)
3. Either place the change back into the retry queue using `ManageHiq.retry` or into the purge queue using `ManageHiq.purge`.

See Also: The Replication Tools chapter in *Oracle Fusion Middleware Reference for Oracle Identity Management* for instructions on how to use the Human Intervention Queue tools

Viewing Queue Statistics and Verifying Replication by Using `remtool`

The Replication Environment Management Tool, `remtool`, enables you to monitor the health of the replication process. You can run `remtool` periodically to ensure that your replication processes are performing properly. `Remtool` has options that display queue statistics and verify replication.

The `remtool` options for monitoring an LDAP-based replication agreement are `-pdispqstat` and `-pverify`. Their syntax is as follows:

```
remtool -pdispqstat [-v] [-bind hostname:port_number]
```

```
remtool -pverify [-v] [-bind hostname:port_number] [-hiqmax hiqmax] [-tbtmax
```

tbtmax]

For an Oracle Database Advanced Replication-based replication agreement, the `remtool` options are `-dispqstat` and `-asrverify`.

Their syntax is as follows:

```
remtool -dispqstat [-connect repl_admin_name@net_service_name] [-v]
```

```
remtool -asrverify [-connect repl_admin_name@net_service_name] [-v]
```

All of these commands prompt for the `replication_dn_password`.

First run `remtool` with the `-pdispqstat` or `-dispqstat` option, depending on the replication type. It shows the queue statistics of the DRG. Check to see if the number of Human Intervention Queue (HIQ) entries and change logs to be transported (Logs TBP) are higher than usual. If so, that means replication is running more slowly than it should. Run `remtool` with the `-pverify` or `-asrverify` option, depending on the replication type, to verify your replication configurations.

If `remtool` with the `-pverify` or `-asrverify` option reports test failure, check the report that it generates and follow the suggestion in the report to fix the specific failures.

See Also: The `remtool` command reference in *Oracle Fusion Middleware Reference for Oracle Identity Management*

Managing the Number of Entries the Human Intervention Queue Tools Can Process

To increase the number of changelogs processed at a time, you must set `orclszlimit` in the replication configuration set and `orclszlimit` in the server instance where replication is running to the same value, a value greater than 1000. You use `ldapmodify` to change both of them. In each case, you would type:

```
ldapmodify -D cn=orcladmin -q -p portNum -h hostname -f ldifFile
```

To set `orclszlimit` in the replication configuration set to 5000, you would use an LDIF file such as:

```
dn: cn=configset0,cn=osdrep1d,cn=subconfigsubentry
changetype: modify
replace: orclszlimit
orclszlimit: 5000
```

To set `orclszlimit` in the server instance to 5000, you would use an LDIF file such as:

```
dn: cn=componentname,cn=osldlapd,cn=subconfigsubentry
changetype: modify
replace: orclszlimit
orclszlimit: 5000
```

Setting the Oracle Internet Directory server instance parameter `orclszlimit` very high impacts server performance, because `orclszlimit` also controls the maximum number of entries to be returned by a search.

See Also:

- ["Attributes of the Instance-Specific Configuration Entry"](#) on page 9-2
- ["The Replication Configuration Set"](#) on page 40-8
- ["Configuring Attributes of the Replication Configuration Set by Using ldapmodify"](#) on page 41-21

Changing the Replication Administrator's Password for Advanced Replication

You can change the password for the replication administrator database account on all nodes of a DRG using Oracle Database Advanced Replication-based replication by using the `-chgpwd` argument to the Replication Environment Management Tool, `remtool`. To use this argument, enter:

```
remtool -chgpwd
```

The `remtool` utility then prompts you for the MDS Global Name—that is, the name of the Master Definition Site—the current password, and the new password. It then asks you to confirm the new password. If you enter an incorrect current password, then you must run the Replication Environment Management Tool again.

You can also use the `-pchgpwd` argument to `remtool` to change the password of the replication DN of a replica.

To change the password only in the replication wallet, `$ORACLE_INSTANCE/OID/admin/oidpwrORACLE_SID`, use the `-pchgwlpwd` argument to `remtool`. To use this argument, enter:

```
remtool -pchgwlpwd
```

See Also: The `remtool` command-line tool reference in *Oracle Fusion Middleware Reference for Oracle Identity Management* for more information about using this tool

Comparing and Reconciling Inconsistent Data by Using oidcmprec

When the directory replication server encounters inconsistent data, you can use the Oracle Internet Directory Comparison and Reconciliation Tool to synchronize the entries on the consumer with those on the supplier. When you do this, perform the following general steps:

1. Set the supplier and the consumer to read-only mode. Use one of the procedures in ["Changing Server Mode"](#) on page 15-2.
2. Ensure that the supplier and the consumer are in a tranquil state—that is, that neither is supplying or applying changes. If they are not in a tranquil state, then wait until they have finished updating.
3. Identify the inconsistent entries or subtree on the consumer.
4. Use the Oracle Internet Directory Comparison and Reconciliation Tool to fix the inconsistent entries or subtree on the consumer.
5. Set the participating supplier and consumer back to read/write mode.

See Also: The `oidcmprec` command-line tool reference in *Oracle Fusion Middleware Reference for Oracle Identity Management* for syntax and an explanation of how Oracle Internet Directory Comparison and Reconciliation Tool works.

The compare and reconcile tool `oidcmprec` enables you to compare two directories. It detects and resolves conflicts. Of the two directories, one directory is considered to be the source directory or "source of truth." The other directory is the destination directory that must be synchronized with the source directory. The directories to be compared can be directories that are not part of any replication group, part of the same replication group, or part of different replication groups.

This section provides an introduction to the `oidcmprec` tool and some examples of `oidcmprec` usage. It includes the following topics:

- [Conflict Scenarios](#)
- [Operations Supported by oidcmprec](#)
- [Output from oidcmprec](#)
- [How oidcmprec Works](#)
- [Setting the Source and Destination Directories](#)
- [Selecting the DIT for the Operation](#)
- [Selecting the Attributes for the Operation](#)
- [Controlling Change Log Generation](#)
- [Using a Text or XML Parameter File](#)
- [Including Directory Schema](#)
- [Overriding Predefined Conflict Resolution Rules](#)
- [Using the User-Defined Compare and Reconcile Operation](#)
- [Known Limitations of the oidcmprec Tool](#)

See Also: The "oidcmprec" command reference in *Oracle Fusion Middleware Reference for Oracle Identity Management* for the complete syntax for `oidcmprec`, including operations, conflict scenarios, and conflict resolution rules.

Conflict Scenarios

The `oidcmprec` tool can detect and resolve the following conflict scenarios:

- Entry only in source directory (`entos`)
- Entry only in destination directory (`entod`)
- Attribute only in source directory (`atros`)
- Attribute only in destination directory (`atrod`)
- Single-valued attribute differs (`svatrdif`)
- Multi-valued attribute differs (`mvatrdif`)
- Entry DN differs (`dndif`)

The `dndif` scenario can occur in a replication environment when a `modrdn` or `moddn` operation performed in one node is not replicated to another node. As a

result, the entry has the same `orclguid` but different DNs on the two nodes. The tool uses the `orclguid` attribute to detect this conflict.

The `oidcmprec` tool can also detect and resolve the following schema conflict scenarios:

- Object class definition exists only in source directory (`odefoss`)
- Object class definition exists only in destination directory (`odefod`)
- Object class definition different in source and destination directory (`odefdif`)
- Attribute definition exists only in source directory (`adefoss`)
- Attribute definition exists only in destination directory (`adefod`)
- Attribute definition different in source and destination directory (`adefdif`)

Operations Supported by oidcmprec

The tool supports five operation. Each operation compares entries, detects conflicts, and optionally resolves them. The operations differ regarding how they resolve conflicts. The operations are as follows:

- Compare operation: compares two directories and stores the changes as LDIF records in a file. The LDIF file can be applied to the destination directory to make it identical to the source directory. Only the data in the source directory is considered valid.
- Reconcile operation: compares two directories and applies necessary changes at the destination directory to make it identical to the source directory. All the changes made to the directory are stored as LDIF records in a file. Only the data in the source directory is considered valid.
- Merge or two-way reconcile operation: compares two directories and applies necessary changes at the source or destination directory to make them identical. The data in both directories is considered valid. For example, when the tool detects that an entry exists only in the destination directory, the tool adds it to the source. This operation also records all the changes applied to the directory as LDIF records in a file.
- Merge dry run operation: compares two directories, similar to the merge operation, but does not apply the changes in the directory. Instead, it stores the changes as LDIF records in a file. The changes to be applied to the source directory and to destination directory are stored in two different files.
- User defined compare and reconcile operation: uses conflict resolution rules that you choose for each conflict scenario. See *Oracle Fusion Middleware Reference for Oracle Identity Management* for a list of conflict resolution rules you can use for each conflict scenario.

Output from oidcmprec

The `oidcmprec` tool normally generates several output files. You can use options to `oidcmprec` to suppress generation of any of the files. The files and their corresponding options are:

- `filename.rpt`: contains the DNs of all entries compared and the compare result. Use `logrpt=false` to suppress generation of this file.
- `filename.s2d.ldif`: contains all changes applied to the destination directory or stored for later application to the destination directory. The name is an

abbreviation for source directory to destination directory. Use `logs2d=false` to suppress generation of this file.

- `filename.d2s.ldif`: contains all changes applied to the source directory or stored for later application to the source directory. The name is an abbreviation for destination directory to source directory. Use `logd2s=false` to suppress generation of this file.
- `filename.eos.rpt`: lists DNs of entries that exist only in the source directory. It also lists name of attributes and object classes that are defined only in the source directory, if the schema is included for the operation. The name is an abbreviation for entries available only in source directory. Use `logeos=false` to suppress generation of this file.
- `filename.eod.rpt`: lists DNs of entries that exist only in the destination directory. It also lists name of attributes and object classes that are defined only in the destination directory, if the schema is included for the operation. The name is an abbreviation for entries available only in destination directory. Use `logeod=false` to suppress generation of this file.
- `filename.dif.rpt`: lists DNs of all entire that differ along with names of attribute that differ. It also lists name of attributes and object classes whose definitions differ, if the schema is included for the operation. This file is known as the dif file. Use `logdif=false` to suppress generation of this file.
- `filename.err`: contains all error messages. This file is known as the err file. Use `logerr=false` to suppress generation of this file.

The tool can dump the total number of entries loaded by the tool in memory and the number of entries in each of `oidcmprec`'s various queues. The entry counts are logged in the file `oidcmprec.log`. Use the `qlogfreq=frequency` argument to specify how frequently `oidcmprec` logs this information. Possible `frequency` values are from 1 to 5000. The lower the value, the shorter the interval. For frequent entry counts, use a value between 5 and 10.

How oidcmprec Works

Using the replication DN and replication DN password as credentials, the tool performs three tasks. First it loads schema information into memory. Next, it collects the entries to be compared and it compares them, attribute by attribute. The tool uses schema information to determine the compare rule to be used for each attribute. Then, based on the compare result, the tool takes the necessary actions. These operations are performed by different threads:

- The DN thread is responsible for collecting entries to be compared. While collecting entries, it does not fetch the entire tree at once. It first fetches the base entry and processes it. Then it fetches the immediate children of the base entry and processes them, and then their immediate children, and so on. The collected entries are passed on to worker threads. You can control the number of DN threads using the `dnthreads` argument.
- The worker thread is responsible for comparing entries attribute by attribute and applying conflict resolution rules. The worker thread then passes on the entry to the log writer thread. You can control the number of worker threads by using the `threads` argument. The total number of worker threads and DN threads cannot exceed a maximum value equal to $6 * (\text{Number of CPUs}) - 2$. If you specify more than that, the tool adjusts the number of worker and DN threads so as not to exceed the maximum.

- The log writer thread is responsible for writing the contents to all seven output files listed in "Output from oidcmprec" on page 41-28. There is only one log writer thread. You cannot increase the number.

These threads are spawned, monitored and terminated by the main thread. The main thread processes command line arguments and parameter files and spawns the other threads. As soon as the main thread detects that all operations are complete, it terminates all threads and cleans up all connections.

Each thread establishes an LDAP connection to the source directory and to the destination directory. These connections remain open until all operations are completed by the thread. If a connection is closed for any reason, the tool tries to reestablish connection if the `continueOnError` argument is set to `TRUE`. If the tool can reestablish the connection, it continues operation.

Note: Use the `continueOnError` argument to specify whether the tool should continue processing on error. This argument can be set to `TRUE` or `FALSE`. By default it is set to `TRUE`.

Setting the Source and Destination Directories

You use the `source` and `destination` options to set the source and destination directories.

```
oidcmprec source=staqj13:3060 destination=staqj:3070 base="" \
scope=subtree file=temp operation=compare
```

The tool prompts for passwords if they are not provided on the command line:

```
Enter replication DN password of the source directory :
Enter replication DN password of the destination directory :
```

Selecting the DIT for the Operation

Use the `base`, `dns2Exclude`, and `scope` options to choose the area to be compared and reconciled.

This example compares the entire directory except `c=us`, `dc=mycom`, `dc=com` and `c=uk`, `dc=mycom`, `dc=com`:

```
oidcmprec base="" \
dns2exclude="'c=us,dc=mycom,dc=com' 'c=uk,dc=mycom,dc=com'" \
operation=compare scope=subtree \
source=myhost1.mycom.com:3060 \
destination=myhost2.mycom.com:3060 \
threads=5 dnthreads=2 file=cmpres
```

This example compares the naming contexts `dc=com` and `dc=org` except for the trees `c=us`, `dc=mycom`, `dc=com` and `c=uk`, `dc=myorg`, `dc=org`.

```
oidcmprec base="'dc=com' 'dc=org'" \
dns2exclude="'c=us,dc=mycom,dc=com' 'c=uk,dc=myorg,dc=org'" \
operation=compare scope=subtree \
source=myhost1.mycom.com:3060 \
destination=myhost2.mycom.com:3060 \
threads=5 dnthreads=2 file=cmpres
```

Selecting the Attributes for the Operation

By default, `oidcmprec` compares all attributes except for the operational attributes `creatorsname`, `createtimestamp`, `modifiersname`, `modifytimestamp`, `orclentrydn`, and `orclnormdn`. You can control the attributes to be included or excluded for the chosen operation using `excludedAttributes` or `includedAttributes`, respectively. The `excludedAttributes` and `includedAttributes` arguments allow limited pattern matching. You can use `attributename*` to match all attributes starting with `attributename`. You can also use `attributename;*` to match all subtypes of `attributename`.

This example excludes the `authpassword` attribute with and without subtype, plus the attributes `userpassword` and `category`, in addition to the standard excluded attributes.

```
oidcmprec operation=compare scope=subtree base="'dc=com' 'dc=org'" \
  source=myhost1.mycom.com:3060 \
  destination=myhost2.mycom.com:3060 \
  exclattr="authpassword authpassword;* userpassword category" \
  threads=5 dnthreads=2 file=compare
```

This example includes only the attributes `uid`, `cn`, `sn`, `givenname`, and `mail` in the compare operation.

```
oidcmprec operation=compare scope=subtree base="'dc=com'" \
  source=myhost1.mycom.com:3060 \
  destination=myhost2.mycom.com:3060 \
  inclattr="uid cn sn givenname mail" \
  file=compare
```

This example includes all attributes for the compare operation except `orclguid`, `creatorsname`, and `modifiersname`. This example also asks the tool to stop when it encounters any error by setting `continueOnError=false`.

```
oidcmprec operation=compare scope=subtree base="'dc=com'" \
  source=myhost1.mycom.com:3060 \
  destination=myhost2.mycom.com:3060 \
  inclattr="*" exclattr="orclguid creatorsname modifiersname" \
  file=compare contonerr=false
```

Controlling Change Log Generation

Change log generation for the changes made by `oidcmprec` depends on the value of the `orclDIPrepository` attribute of the root DSE. Change log generation behavior, however, can be controlled by using the `generateChangeLog` argument. The `generateChangeLog` argument can have the following values:

- `default`: The directory server settings determine whether a change log is generated or not. Change logs are generated if the root entry's `orclDIPrepository` attribute is set to `true`. They are not generated if `orclDIPrepository` is set to `false`. The same rule applies for both the source and destination directories. `default` is the default value for `gechglog`.
- `true`: Change logs are always generated, irrespective of the settings on the source and destination directories.
- `false`: Change logs are never generated, irrespective of the settings on the source and destination directories.

In the following example, `generateChangeLog false` turns off change log generation:

```
oidcmprec operation=merge scope=subtree base="'dc=com' " \
source=myhost1.mycom.com:3060 \
destination=myhost2.mycom.com:3060 \
inclattr="*" exclattr="orclguid creatorsname modifiersname" \
file=merge genchglog=false
```

Using a Text or XML Parameter File

All the arguments that can be given on the `oidcmprec` command line can also be stored in a parameter file. You specify a text parameter file using the `parameterFile` option. You specify an xml parameter file using the `xmlparameterFile` option. If you specify an argument both on the command line and in the parameter file, the argument specified on the command line takes precedence over the one specified in the parameter file. For example:

```
oidcmprec paramfile=comp_param threads=4
```

This example uses the following sample text parameter file:

```
#####
#Parameter file for compare and reconcile tool
#Creator   : John
#Date      : 21-Mar-2006
#File Name : comp_param
#####
operation=compare
source=staqj13:3060/ods
destination=staqj13:3070/ods
base='("cn=oraclecontext" "c=uk,dc=mycom,dc=com" "c=us,dc=mycom,dc=com")'
verbose=false
force=true
threads=6
dnthreads=2
excludedAttributes=orclguid userpassword authpassword authpassword;*
filename=cmp2006Feb01
```

In this example, the tool spawns four worker threads. It gives precedence to command line arguments.

Here is an XML parameter file equivalent to the sample text parameter file:

```
<?xml version="1.0" standalone="yes" ?>
- <input>
  <operation>compare</operation>
- <source>
  <host>staqj13</host>
  <port>3070</port>
</source>
- <destination>
  <host>staqj13</host>
  <port>3070</port>
</destination>
  <base>
    <dn>cn=oraclecontext</dn>
    <dn>c=uk,dc=mycom,dc=com</dn>
    <dn>c=us,dc=mycom,dc=com</dn>
  </base>
  <threads>6</threads>
  <dnthreads>2</dnthreads>
  <exclattr>
    <attribute>orclguid</attribute>
```

```

    <attribute>userpassword</attribute>
    <attribute>authpassword</attribute>
  <exclattr/>
  <force>true</force>
  <verbose>>false</verbose>
  <filename>cmp2006Feb01</filename>
</input>

```

Including Directory Schema

You can include the schema in an `oidcmprec` operation by including `cn=subschemasubentry` in the base argument. For example:

```

oidcmprec operation=merge scope=subtree \
  base="'dc=com' 'cn=subschemasubentry'" \
  source=myhost1.mycom.com:3060 \
  destination=myhost2.mycom.com:3060 \
  inclattr="*" exclattr="orclguid creatorsname modifiersname" \
  file=merge genchglog=false

```

If you include other DNs in addition to the schema, `oidcmprec` performs the operation on the schema first.

Overriding Predefined Conflict Resolution Rules

Conflict scenarios and conflict resolution rules for each operation are described in the "oidcmprec" command reference in *Oracle Fusion Middleware Reference for Oracle Identity Management*.

You can override the predefined conflict resolution rules by specifying the conflict name and the rule to use in the command line or parameter file. The following example changes the conflict resolution rule used for the conflicts `dndif` and `mvatrdif` to ignore for the compare operation:

```

oidcmprec operation=compare source=host1:3060 destination=host2:3070 \
  base="" scope=subtree file=temp operation=compare \
  dndif=ignore mvatrdif=ignore

```

Using the User-Defined Compare and Reconcile Operation

In addition to the predefined operations `compare`, `reconcile`, `merge`, and `merge dry run`, `oidcmprec` has a user-defined compare and reconcile operation, `userdefinedcr`, that enables you to specifying conflict resolution rule arguments. Any conflict resolution rule you do not specify with `-userdefinedcr` defaults to ignore. The following command line uses the `userdefinedcr` operation:

```

oidcmprec operation=userdefinedcr scope=subtree \
  base="'dc=com' 'dc=org'" \
  source=myhost1.mycom.com:3060 \
  destination=myhost2.mycom.com:3060 \
  entos=add entod=ignore atos=add atrod=ignore \
  svatrdif=usesrc mvatrdif=usesrc dndif=ignore \
  threads=5 dnthreads=2 file=myreconcile

```

Conflict scenarios and conflict resolution rules are described in the "oidcmprec" command reference in *Oracle Fusion Middleware Reference for Oracle Identity Management*.

Known Limitations of the oidcmprec Tool

The `oidcmprec` tool has the following limitations:

- When the tool logs changes to LDIF records in the `filename.s2d.ldif` or `filename.d2s.ldif` file for deletion of a tree, it logs the parent record first, followed by its children. If you attempt to apply this change using the `ldapmodify` command-line tool, it fails, as the directory server does not allow deletion of non-leaf entry. To prevent `ldapmodify` from failing, edit the file to reorder the records before running `ldapmodify`.
- When the tool performs a delete operation on an entry, it deletes that entry and its children. The tool records that the entry was deleted, but does not log that its children were also deleted.
- The tool has limitations with respect to compound RDNs. These are RDNs that contain two or more `attribute=attrvalue` pairs, separated by a `+`, for example:

```
uid=jpaul + cn=john paul + mail=john.paul@example.com,dc=oracle,dc=com
```

If one of the directories you are comparing contains a compound RDN, when the tool suggests `modrdn/moddn` changes in the `filename.s2d.ldif` or `filename.d2s.ldif` file, the `deleteoldrdn` value might be incorrect.

- If you have provided a filter to `oidcmprec`, and you plan to use the output as input to `ldapmodify`, first edit the output to ensure that entries are in the correct order. In particular, if you are migrating a whole tree, ensure that the root of the tree is the first entry.

Part VI

Advanced Administration: Directory Plug-ins

This part contains these chapters:

- [Chapter 43, "Developing Plug-ins for the Oracle Internet Directory Server"](#)
- [Chapter 42, "Configuring a Customized Password Policy Plug-In"](#)
- [Chapter 44, "Configuring a Customized External Authentication Plug-in"](#)

Configuring a Customized Password Policy Plug-In

Oracle Internet Directory uses plug-ins to add password value checking to its other password policy management capabilities. These plug-ins enable you to verify that, for example, a new or modified password has the specified minimum length. You can customize password value checking to meet your own requirements.

This chapter contains these topics:

- [Introduction to Configuring a Customized Password Policy Plug-in](#)
- [Installing, Configuring, and Enabling a Customized Password Policy Plug-in](#)

Introduction to Configuring a Customized Password Policy Plug-in

When a user wants to add or modify a password, customized password value checking takes place as follows:

1. The client sends the directory server either an ldapadd or ldapmodify request.
2. Before the directory server makes the addition or modification, it passes the password value to the plug-in.
3. The plug-in
 - a. Parses the entry
 - b. Captures the userpassword attribute value in clear text
 - c. Implements whatever password value checking you have specified
4. If the password meets the specification, then the plug-in notifies the directory server accordingly, and the directory server makes the addition or modification.

Otherwise, the plug-in sends one of the following error messages to the directory server, which, in turn, passes it to the client.

```
ldap_add: UnKnown Error Encountered
ldap_add: additional info: PASSWORD POLICY VIOLATION:0000X, less than 8 chars
```

```
ldap_add: UnKnown Error Encountered
ldap_add: additional info: PASSWORD POLICY VIOLATION:0000X, contains dictionary
word
```

The same logic applies to the PRE ldapmodify plug-in.

The various kinds of value checks that a password policy plug-in could perform include:

- Minimum and maximum number of alphabetic characters
- Maximum number of numeric characters
- Minimum and maximum number of punctuation characters
- Maximum number of consecutive characters
- Maximum number of instances of any character
- Whether it is a dictionary word

Installing, Configuring, and Enabling a Customized Password Policy Plug-in

This example uses the PL/SQL program, `pluginpkg.sql`. ["Contents of Sample PL/SQL Package pluginpkg.sql"](#) on page 42-4 describes this program. In general, this package contains:

- Two plug-in modules: `pre_add` and `pre_modify`
- One value checking function, `isGoodPwd`, which verifies that a password meets the minimum length requirement of eight characters and that it does not contain a dictionary word that is longer than four characters

Thus, in this example, if you try to add a user with the `userpassword` value less than eight characters, then the request is rejected. Similarly, if you try to modify a user password, and the new password value is less than eight characters, then the request is rejected. Also, if you try to add or modify a user with the `userpassword` `supersunday`, the password is rejected because `super` and `sunday` are dictionary words.

The dictionary is a list of words longer than four characters, initially stored in a file called `words.txt`. Before we implement the plug-in, we set up a database table and store the words into the table. To set up the table we use `create.sql`, which has the following contents:

```
drop table mydic;
create table mydic (word varchar2(1024));
commit;
exit;
```

Then we load the words into the table using the `sqlldr` command:

```
sqlldr control=words.txt userid=ods/ods_password
```

This section contains these topics:

- [Loading and Registering the PL/SQL Program](#)
- [Coding the Password Policy Plug-in](#)
- [Debugging the Password Policy Plug-in](#)
- [Contents of Sample PL/SQL Package pluginpkg.sql](#)

Loading and Registering the PL/SQL Program

After you implement the standalone value checking PL/SQL program, do the following:

1. Load the plug-in package into the database. In this example, we enter:

```
sqlplus ods @pluginpkg.sql
```

2. Register the plug-in. This example uses a file named `pluginreg.dat`, which contains the following:

```
### add plugin ###
dn: cn=pre_add_plugin,cn=plugin,cn=subconfigsubentry
objectclass:orclPluginConfig
objectclass:top
orclpluginname:pwd_plugin
orclplugintype:operational
orclplugintiming:pre
orclpluginldapoperation:ldapadd
orclpluginenable:1
orclpluginversion:1.0.1
cn:pre_add_plugin
orclpluginsubscriberdnlist:dc=com;o=IMC ,c=US

### modify plugin ###
dn: cn=pre_mod_plugin,cn=plugin,cn=subconfigsubentry
objectclass:orclPluginConfig
objectclass:top
orclpluginname:pwd_plugin
orclplugintype:operational
orclplugintiming:pre
orclpluginldapoperation:ldapmodify
orclpluginenable:1
orclpluginversion:1.0.1
cn:pre_mod_plugin
orclpluginsubscriberdnlist:dc=com;o=IMC ,c=US
orclpluginattributelist:userpassword
```

Note that, in this plug-in, we let the directory server know that there are two plug-in modules to invoke when it receives `ldapadd` or `ldapmodify` requests. We use `orclpluginsubscriberdnlist:dc=com;o=IMC ,c=US` so that the plug-in is invoked ONLY if the target entry is under `dc=com` or `o=IMC ,c=US`.

To add this file to the directory, enter the following:

```
ldapadd -p portnum -h hostname -D cn=orcladmin -q -v -f pluginreg.dat
```

Coding the Password Policy Plug-in

You can use standard PL/SQL character functions to process the password value. Download any PL/SQL program that can do regular expression. The important thing is to integrate the value checking functions with your plug-in modules.

Debugging the Password Policy Plug-in

Turn on the directory server plug-in to help you examine the process and content of plug-ins.

To setup the directory server plug-in debugging, execute the following command:

```
sqlplus ods @$ORACLE_HOME/ldap/admin/oidspdsu.pls
```

To enable directory server plug-in debugging, execute the following command:

```
sqlplus ods @$ORACLE_HOME/ldap/admin/oidspdon.pls
```

To disable directory server plug-in debugging, execute the following command:

```
sqlplus ods @$ORACLE_HOME/ldap/admin/oidspdof.pls
```

To show directory server plug-in debugging messages, execute the following command:

```
sqlplus ods @$ORACLE_HOME/ldap/admin/oidspdsh.pls
```

To delete directory server plug-in debugging messages, execute the following command:

```
sqlplus ods @$ORACLE_HOME/ldap/admin/oidspdde.pls
```

Contents of Sample PL/SQL Package pluginpkg.sql

The script `pluginpkg.sql`, as used in this example, contains the following:

```
CREATE OR REPLACE PACKAGE pwd_plugin AS

PROCEDURE pre_add (ldapplugincontext IN ODS.plugincontext,
  dn      IN VARCHAR2,
  entry   IN ODS.entryobj,
  rc      OUT INTEGER,
  errmsg  OUT VARCHAR2
);

PROCEDURE pre_modify (ldapplugincontext IN ODS.plugincontext,
  dn      IN VARCHAR2,
  mods    IN ODS.modlist,
  rc      OUT INTEGER,
  errmsg  OUT VARCHAR2
);

-- Function: isGoodPwd
-- Parameter: inpwd
-- Purpose: 1. check if the password is at least
--           8 characters long
--           2. check if the password contains a
--           dictionary word (longer than 4 characters)

FUNCTION isGoodPwd(inpwd IN VARCHAR2)
  RETURN INTEGER;

END pwd_plugin;
/

show error

CREATE OR REPLACE PACKAGE BODY pwd_plugin AS

FUNCTION isGoodPwd(inpwd IN VARCHAR2)
  RETURN INTEGER
  IS
    i NUMBER;
    ret NUMBER DEFAULT 1;
    minpwdlen NUMBER DEFAULT 8;
    len      NUMBER DEFAULT 0;
    lcount   NUMBER DEFAULT 0;
    matched  VARCHAR2(1024) DEFAULT NULL;
```

```

        CURSOR c1 IS
        SELECT word FROM mydic WHERE length(word) > 4
        AND instr(lower(inpwd), lower(word), 1, 1) > 0;

BEGIN
    plg_debug( '=== begin of ISGOODPWD ===');
    plg_debug( 'password = ' || inpwd);
    len := LENGTH(inpwd);
    plg_debug( 'password length = ' || len);

    IF len < minpwdlen THEN
        RETURN 0;
    ELSE
        OPEN c1;
        LOOP
            FETCH c1 INTO matched;
            EXIT WHEN c1%NOTFOUND;
            lcount := lcount + 1;
        END LOOP;
        plg_debug( 'count = ' || lcount);
        IF lcount > 0 THEN
            RETURN 2;
        ELSE
            RETURN ret;
        END IF;
    END IF;

    plg_debug( '=== end of ISGOODPWD ===');

EXCEPTION
    WHEN OTHERS THEN
        plg_debug( 'Exception in isGoodPwd(). Error code is ' || TO_CHAR(SQLCODE));
        plg_debug( ' ' || Sqlerrm);
        RETURN 0;
END;

PROCEDURE pre_add (ldapplugincontext IN ODS.plugincontext,
    dn          IN VARCHAR2,
    entry       IN ODS.entryobj,
    rc          OUT INTEGER,
    errormsg    OUT VARCHAR2
)
IS
    inpwd VARCHAR2(256) DEFAULT NULL;
    ret    NUMBER        DEFAULT 1;
BEGIN
    plg_debug( '=== begin of PRE_ADD_PLUGIN ===');
    plg_debug( 'dn = ' || dn);

    plg_debug( 'entry obj ' || ':entryname = ' || entry.entryname);

    FOR l_counter1 IN 1..entry.attr.COUNT LOOP
        plg_debug( 'attrname[' || l_counter1 || '] = ' ||
entry.attr(l_counter1).attrname);
        FOR l_counter2 IN 1..entry.attr(l_counter1).attrval.COUNT LOOP
            plg_debug( entry.attr(l_counter1).attrname ||
                '[' || l_counter1 || ']' ||
                '.val[' || l_counter2 || '] = ' ||
                entry.attr(l_counter1).attrval(l_counter2));
        END LOOP;
    END LOOP;
END;

```

```

        END LOOP;

        IF entry.attr(l_counter1).attrname = 'userpassword' THEN
inpwd := entry.attr(l_counter1).attrval(1);
-- assuming only one attr val for userpassword
        END IF;

    END LOOP;

    IF (inpwd IS NOT NULL) THEN
        ret := isGoodPwd(inpwd);
    END IF;

    IF (inpwd IS NULL OR ret = 0) THEN
        rc := 1;
        errormsg := 'PASSWORD POLICY VIOLATION:0000X, less than 8 chars';
        plg_debug( ' we got an invalid password, too short ');
    ELSIF (ret = 2) THEN
        rc := 1;
        errormsg := 'PASSWORD POLICY VIOLATION:0000X, contains dictionary word';
        plg_debug( ' we got an invalid password, dictionary word ');
    ELSE
        plg_debug( ' we got a good password ');
        rc := 0;
        errormsg := 'no pre_mod plguin error msg';
    END IF;

    plg_debug( '=== end of PRE_ADD_PLUGIN ===');

EXCEPTION
    WHEN OTHERS THEN
        plg_debug( 'Exception in PRE_ADD plugin. Error code is ' || TO_
CHAR(SQLCODE));
        plg_debug( ' ' || Sqlerrm);
        rc := 1;
        errormsg := 'exception: pre_add plguin';
END;

PROCEDURE pre_modify (ldapplugincontext IN ODS.plugincontext,
    dn          IN VARCHAR2,
    mods        IN ODS.modlist,
    rc          OUT INTEGER,
    errormsg    OUT VARCHAR2
)
IS
    old_passwd VARCHAR2(256) DEFAULT NULL;
    new_passwd VARCHAR2(256) DEFAULT NULL;
    ret        NUMBER        DEFAULT 1;

BEGIN
    plg_debug( '=== begin of PRE_MOD_PLUGIN ===');
    plg_debug( dn);

    FOR l_counter1 IN 1..mods.COUNT LOOP
        IF (mods(l_counter1).operation = 2) AND
(mods(l_counter1).type = 'userpassword') THEN

            FOR l_counter2 IN 1..mods(l_counter1).vals.COUNT LOOP
                new_passwd := mods(l_counter1).vals(l_counter2).val;
            END LOOP;

```

```

        END IF;

        IF (mods(l_counter1).operation = 0) AND
(mods(l_counter1).type = 'userpassword') THEN

FOR l_counter2 IN 1..mods(l_counter1).vals.COUNT LOOP
    new_passwd := mods(l_counter1).vals(l_counter2).val;
END LOOP;
    END IF;

        IF (mods(l_counter1).operation = 1) AND
(mods(l_counter1).type = 'userpassword') THEN

FOR l_counter2 IN 1..mods(l_counter1).vals.COUNT LOOP
    old_passwd := mods(l_counter1).vals(l_counter2).val;
END LOOP;
    END IF;
END LOOP;

plg_debug(' new password: ' || new_passwd);
plg_debug(' old password: ' || old_passwd);

IF (new_passwd IS NOT NULL) THEN
    ret := isGoodPwd(new_passwd);
END IF;

IF (new_passwd IS NULL OR ret = 0) THEN
    rc := 1;
    errormsg := 'PASSWORD POLICY VIOLATION:0000X, less than 8 chars';
    plg_debug( ' we got an invalid password, too short ');
ELSIF (ret = 2) THEN
    rc := 1;
    errormsg := 'PASSWORD POLICY VIOLATION:0000X, contains dictionary word';
    plg_debug( ' we got an invalid password, dictionary word ');
ELSE
    plg_debug( ' we got a good password ');
    rc := 0;
    errormsg := 'no pre_mod plguin error msg';
END IF;

plg_debug( '=== end of PRE_MOD_PLUGIN ===');

EXCEPTION
    WHEN OTHERS THEN
        plg_debug( 'Exception in PRE_MODIFY plugin. Error code is ' || TO_
CHAR(SQLCODE));
        plg_debug( ' ' || Sqlerrm);
        rc := 1;
        errormsg := 'exception: pre_mod plguin';
END;

END pwd_plugin;
/
show error

EXIT;
```

Developing Plug-ins for the Oracle Internet Directory Server

This chapter introduces Oracle Internet Directory server plug-ins and presents an overview of the plug-in framework for Oracle Internet Directory.

This chapter contains these topics:

- [Introduction to Developing Plug-ins for the Oracle Internet Directory Server](#)
- [Creating a Plug-in](#)
- [Registering a Plug-in From the Command Line](#)
- [Managing Plug-ins by Using Oracle Directory Services Manager](#)

Introduction to Developing Plug-ins for the Oracle Internet Directory Server

A server plug-in is a customized program that can be used to extend the capabilities of the Oracle Internet Directory server. A server plug-in can be a PL/SQL package, Java program or package, shared object or library, or a dynamic link library on Windows. Each plug-in has a configuration entry in the Oracle Internet Directory Server. The configuration entry specifies the conditions for invoking the plug-in. The conditions for invoking a plugin include:

- An LDAP operation, such as `ldapbind` or `ldapmodify`
- A timing, relative to the LDAP operation, such as `pre_bind` or `post_modify`

Directory server plug-ins can provide the directory server with the following kinds of added functionality, to mention just a few:

- Validate data before the directory server performs an operation on it
- Perform specified actions after the server performs an operation
- Define password policies
- Authenticate users through external credential stores

On startup, the directory server loads your plug-in configuration and library. Then, when it processes requests, it calls your plug-in functions whenever the specified event takes place.

In [Figure 43-1](#), LDAP clients, each using a separate application, send information to and receive it from the Oracle directory server. Plug-in configuration tools likewise send information to the directory server. The directory server sends data to Plug-in Module 1, Plug-in Module 2, and Plug-in Module 3. Each plug-in module has both a

plug-in module interface and plug-in logic. Each plug-in module sends information to and receives it from the LDAP API and the Plug-in LDAP.

Figure 43–1 Oracle Internet Directory Plug-in Framework

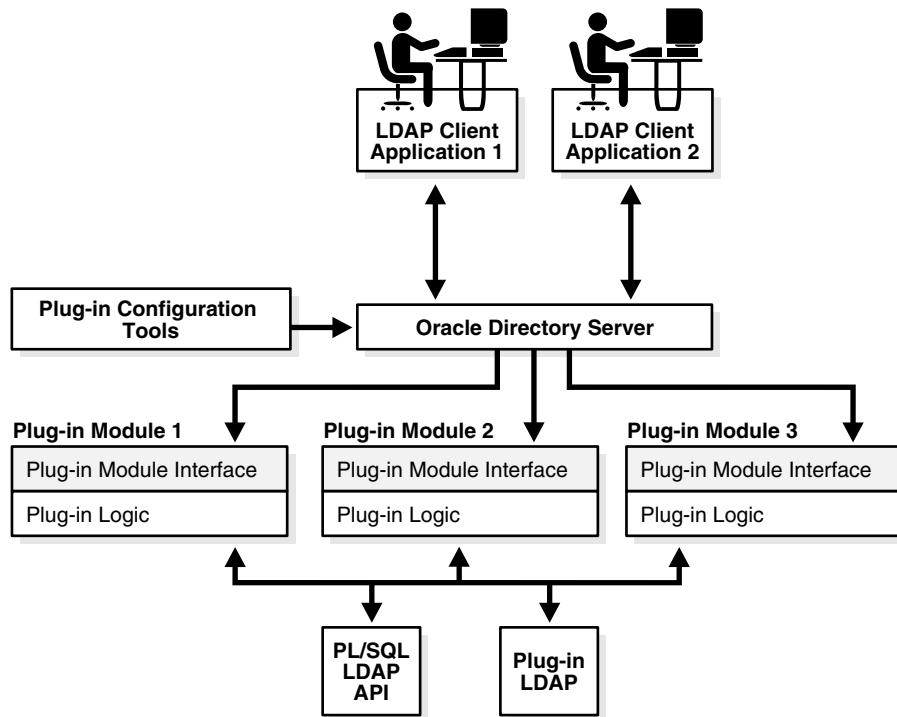

The work that plug-ins perform depends on whether they execute before, after, or in addition to normal directory server operations. The next section explains the various kinds of operation-based plug-ins.

Supported Languages for Server Plug-ins

As of 10g (10.1.4.0.1), Oracle Internet Directory supports plug-ins in Java and in PL/SQL. This chapter provides information common to Java and PL/SQL plug-ins. [Appendix F](#) provides additional information specific to PL/SQL plug-ins and [Appendix E](#) provides additional information specific to Java plug-ins.

Server Plug-in Prerequisites

To develop Oracle Internet Directory plug-ins, you should be familiar with the following topics:

- Generic LDAP concepts
- Oracle Internet Directory
- Oracle Internet Directory integration with Oracle Application Server

You should have programming skills in one of the following areas:

- SQL, PL/SQL, and database RPCs
- Java

Server Plug-in Benefits

Some of the ways you can extend LDAP operations by using plug-ins include the following:

- You can validate data before the server performs an LDAP operation on the data.
- You can perform actions that you define after the server successfully completes an LDAP operation.
- You can define extended operations.
- You can authenticate users through external credential stores.
- You can replace an existing server module with your own server module

On startup, the directory server loads your plug-in configuration and library. It calls your plug-in functions while processing various LDAP requests.

See Also: The chapter about the password policy plug-in in *Oracle Fusion Middleware Administrator's Guide for Oracle Internet Directory*. The chapter contains an example of how to implement your own password value checking and place it into the Oracle Internet Directory server.

Guidelines for Designing Plug-ins

Use the following guidelines when designing plug-ins:

- Use plug-ins to guarantee that when a specific LDAP operation is performed, related actions are also performed.
- Use plug-ins only for centralized, global operations that should be invoked for the program body statement, regardless of which user or LDAP application issues the statement.
- Do not create recursive plug-ins. For example, creating a `pre_ldap_bind` plug-in that itself issues an `ldapbind` statement would cause the plug-in to execute recursively until it has run out of resources.

Use plug-ins judiciously. They are executed every time the associated LDAP operation occurs.

The Server Plug-in Framework

The plug-in framework is the environment in which you develop, configure, and apply the plug-ins. Each individual plug-in instance is called a plug-in module.

The plug-in framework includes the following:

- Plug-in configuration tools
- Plug-in module interface
- Plug-in LDAP APIs:
 - PL/SQL package `ODS.LDAP_PLUGIN`
 - Java package `oracle.ldap.ospf`

For both languages, you follow these general steps to use the server plug-in framework:

1. Write a user-defined plug-in procedure in PL/SQL or Java.
2. Compile the plug-in module.

3. Register the plug-in module through the configuration entry interface by using either the command line or Oracle Directory Services Manager.

LDAP Operations and Timings Supported by the Directory

The Oracle Internet Directory server supports plug-ins for the following LDAP operations:

- `ldapadd`
- `ldapbind`
- `ldapcompare`
- `ldapdelete`
- `ldapmoddn` (Java only)
- `ldapmodify`
- `ldapsearch`

Oracle Internet Directory supports four operation timings for plug-ins:

- `pre`
- `post`
- `when`
- `when_replace`

These are explained in the next four sections.

Pre-Operation Server Plug-ins

The server calls pre-operation plug-in modules before performing the LDAP operation. The main purpose of this type of plug-in is to validate data before the data is used in the LDAP operation.

When an exception occurs in the pre-operation plug-in, one of the following occurs:

- When the return error code indicates warning status, the associated LDAP request proceeds.
- When the return code indicates failure status, the request does not proceed.

If the associated LDAP request fails later on, the directory does not roll back the committed code in the plug-in modules.

Post-Operation Server Plug-ins

The Oracle Internet Directory server calls post-operation plug-in modules after performing an LDAP operation. The main purpose of this type of plug-in is to invoke a function after a particular LDAP operation is executed. For example, logging and notification are post-operation plug-in functions.

When an exception occurs in the post-operation plug-in, the associated LDAP operation is not rolled back.

If the associated LDAP request fails, the post plug-in is still executed.

When-Operation Server Plug-ins

The directory calls when-operation plug-in modules while performing standard LDAP operations. A when-operation plug-in executes immediately before the server's own

code for the operation. The main purpose of this type of plug-in is to augment existing operations within the same LDAP transaction. If the when-operation plug-in fails, the standard LDAP operation does not execute. If the when-operation plug-in completes successfully, but the standard LDAP operation fails, then the changes made in the plug-in are not rolled back.

You can, for example, use a when-operation plug-in with the `ldapcompare` operation. The directory executes its server compare code and executes the plug-in module defined by the plug-in developer.

PL/SQL when-operation plug-ins are supported in `ldapadd`, `ldapdelete`, and `ldapmodify`. Java when-operation plug-ins are supported in `ldapadd`, `ldapdelete`, `ldapmoddn`, `ldapmodify`, and `ldapsearch`.

When_Replace-Operation Server Plug-ins

A `when_replace`-operation plug-in executes instead of the server's code for the operation. You can, for example, use a `when_replace` plug-in with the `ldapcompare` operation. The directory does not execute its compare code. Instead it relies on the plug-in module to perform the comparison.

PL/SQL `when_replace`-operation plug-ins are supported only in `ldapadd`, `ldapcompare`, `ldapdelete`, `ldapmodify`, and `ldapbind`.

Java `when_replace`-operation plug-ins are supported in `ldapadd`, `ldapbind`, `ldapcompare`, `ldapdelete`, `ldapmoddn`, `ldapmodify` and `ldapsearch`.

Using Plug-ins in a Replication Environment

Use caution when deploying plug-ins in a replication environment. The following bad practices can result in an inconsistent state:

- Plug-in metadata replicated to other nodes
- Plug-in installation on some, but not all, of the participating nodes
- Implementation in the plug-in of extra checking that depends on the directory data
- Changes to directory entries by plug-in programs or other LDAP operations

You can use plug-ins that change directory entries in a replication environment if you deploy the plug-in on all nodes and configure the plug-in so that changes caused by replication do not invoke the plug-in. You do that as follows:

- Add the replica IDs of all the nodes to a group.
- Include the group as a value in the plug-in attribute `orclpluginrequestneggroup`. For example:

```
orclpluginrequestneggroup: cn=pluginNegate,cn=groups,cn=oraclecontext.
```

Whenever a plug-in detects that a change request has come from a member of the group `cn=pluginNegate`, the plug-in is not invoked.

Creating a Plug-in

Follow these general steps to use the server plug-in framework:

1. Write a user-defined plug-in procedure in PL/SQL or Java.
2. Compile the plug-in module.

3. Register the plug-in module through the configuration entry interface by using either the command line or Oracle Directory Services Manager.

Registering a Plug-in From the Command Line

To enable the directory server to call a plug-in at the right time, you must register the plug-in with the directory server. You do this by creating an entry for the plug-in in the directory schema under `cn=plugin, cn=subconfigsubentry`.

Creating a Plug-in Configuration Entry

[Table 43–1](#) lists and describes the object classes and attributes you can specify in a plug-in configuration.

Table 43–1 Plug-in Configuration Objects and Attributes

Name	Value	Mandatory?
<code>objectclass</code>	<code>orclPluginConfig</code>	Yes
<code>objectclass</code>	<code>top</code>	No
<code>dn</code>	Plug-in entry DN	Yes
<code>cn</code>	Plug-in entry name	Yes
<code>orclPluginAttributeList</code>	A semicolon-separated list of attribute names that controls whether the plug-in takes effect. If the target attribute is included in the list, then the plug-in is invoked. Only for <code>ldapcompare</code> and <code>ldapmodify</code> plug-ins.	No
<code>orclPluginEnable</code>	0 = disable (default) 1 = enable	No
<code>orclPluginEntryProperties</code>	An <code>ldapsearch</code> filter type value. For example, if we specify <code>orclPluginEntryProperties: (&(objectclass=inetorgperson)(sn=Cezanne))</code> , the plug-in is not invoked if the target entry has <code>objectclass</code> equal to <code>inetorgperson</code> and <code>sn</code> equal to <code>Cezanne</code> .	No
<code>orclPluginIsReplace</code>	0 = disable (default) 1 = enable For <code>when_replace</code> timing, enable this and set <code>orclPluginTiming</code> to <code>when</code> .	No
<code>orclPluginKind</code>	PL/SQL or Java (Default is PL/SQL)	No
<code>orclPluginLDAPOperation</code>	One of the following values: <code>ldapcompare</code> <code>ldapmodify</code> <code>ldapbind</code> <code>ldapadd</code> <code>ldapdelete</code> <code>ldapsearch</code> <code>ldapmoddn</code> (Java Only)	Yes
<code>orclPluginName</code>	Plug-in name	Yes

Table 43–1 (Cont.) Plug-in Configuration Objects and Attributes

Name	Value	Mandatory?
orclPluginFlexfield	Custom text information (Java only). To indicate a subtype, specify <code>orclPluginFlexfield;subtypename</code> , for example, <code>orclPluginFlexfield;minPwdLength: 8</code>	No
orclPluginBinaryFlexfield	Custom binary information (Java only).	No
orclPluginSecuredFlexfield	Custom text information that must never be displayed in clear text (Java only). To indicate a subtype, specify <code>orclPluginSecuredFlexfield;subtypename</code> , for example <code>orclPluginSecuredFlexfield;telephoneNumber1: 650.123.456</code> . The value is stored and displayed in encrypted form. In a search result, it might appear as something like this: <code>orclPluginSecuredFlexfield;telephoneNumber1: 1291zjs8134</code> . Be sure that Oracle Internet Directory has privacy mode enabled to ensure that users cannot retrieve this attribute in clear text. See "Privacy of Retrieved Sensitive Attributes" in <i>Oracle Fusion Middleware Administrator's Guide for Oracle Internet Directory</i> .	No
orclPluginRequestGroup	A semicolon-separated group list that controls if the plug-in takes effect. You can use this group to specify who can actually invoke the plug-in. For example, if you specify <code>orclpluginrequestgroup:cn=security,cn=groups,dc=oracle,dc=com</code> when you register the plug-in, the plug-in is not invoked unless the ldap request comes from the person who belongs to the group <code>cn=security,cn=groups,dc=oracle,dc=com</code> .	No
orclPluginRequestNegGroup	A semicolon-separated group list that controls if the plug-in takes effect. You can use this group to specify who cannot invoke the plug-in. For example, if you specify <code>orclpluginrequestgroup:cn=security,cn=groups,dc=oracle,dc=com</code> , when you register the plug-in, the plug-in is not invoked if the LDAP request comes from the person who belongs to the group <code>cn=security,cn=groups,dc=oracle,dc=com</code> .	No
orclPluginResultCode	An integer value to specify the ldap result code. If this value is specified, then plug-in is invoked only if the LDAP operation is in that result code scenario. This is only for the post plug-in type.	No
orclPluginShareLibLocation	File location of the dynamic linking library. If this value is not present, then Oracle Internet Directory server assumes the plug-in language is PL/SQL.	No

Table 43–1 (Cont.) Plug-in Configuration Objects and Attributes

Name	Value	Mandatory?
orclPluginSubscriberDNList	A semicolon separated DN list that controls if the plug-in takes effect. If the target DN of an LDAP operation is included in the list, then the plug-in is invoked.	No
orclPluginTiming	One of the following values: pre when post For when_replace timing, specify when and enable orclPluginIsReplace.	No
orclPluginType	One of the following values: configuration attribute password_policy syntax matchingrule See Also: "LDAP Operations and Timings Supported by the Directory" on page 43-4.	Yes
orclPluginVersion	Supported plug-in version number	No
orclPluginClassReloadEnabled	If this value is 1, the server reloads the plug-in class every time it invokes the plug-in. If the value is 0, the server loads the class only the first time it invokes the plug-in.	No

Adding a Plug-in Configuration Entry by Using Command-Line Tools

To add a plug-in configuration entry from the command line, create an LDIF file containing the plug-in configuration. Specify a DN under `cn=plugin,cn=subconfigsentry`.

The following two-part LDIF file, `my_ldif_file.ldif`, creates an entry for an operation-based plug-in called `my_plugin1`:

```
dn: cn=when_comp,cn=plugin,cn=subconfigsentry
objectclass: orclPluginConfig
objectclass: top
orclPluginName: my_plugin1
orclPluginType: configuration
orclPluginTiming: when
orclPluginLDAPOperation: ldapcompare
orclPluginEnable: 1
orclPluginVersion: 1.0.1
orclPluginIsReplace: 1
cn: when_comp
orclPluginKind: PLSQL
orclPluginSubscriberDNList: dc=COM,c=us;dc=us,dc=oracle,dc=com;dc=org,dc=us;
o=IMC,c=US
orclPluginAttributeList: userpassword

dn: cn=post_mod_plugin, cn=plugin,cn=subconfigsentry
objectclass: orclPluginConfig
objectclass: top
```



```
orclPluginName: my_plugin1
orclPluginType: configuration
orclPluginTiming: post
orclPluginLDAPOperation: ldapmodify
orclPluginEnable: 1
orclPluginVersion: 1.0.1
cn: post_mod_plugin
orclPluginKind: PLSQL
```

Add this file to the directory with a command similar to this:

```
ldapadd -p 3060 -h myhost -D binddn -q -f my_ldif_file.ldif
```

Note: The plug-in configuration entry is not replicated. Replicating it would create an inconsistent state.

Managing Plug-ins by Using Oracle Directory Services Manager

You can register, edit, and delete plug-ins by using Oracle Directory Services Manager.

Creating a New Plug-in by Using Oracle Directory Services Manager

To create a new plug-in:

1. Invoke Oracle Directory Services Manager and connect to the Oracle Internet Directory server as described in "[Invoking Oracle Directory Services Manager](#)" on page 7-9.
2. From the task selection bar, select **Advanced**.
3. Expand **Plug-in**. Entries appear in the left panel.
4. To enable a plug-in management configuration entry, select it.
5. Click the **Create** icon. The New Plug-in window appears in the right pane.
6. Select **Plug-in Enable** if you want to enable the plug-in now.
7. Enter the **Plug-in Name**.
8. Select values for the other mandatory properties.
9. When you have finished entering the values, select **OK**. The plug-in you just created is now listed on the left side of the page.

Registering a Plug-in by Using Oracle Directory Services Manager

To register a plug-in:

1. Invoke Oracle Directory Services Manager and connect to the Oracle Internet Directory server as described in "[Invoking Oracle Directory Services Manager](#)" on page 7-9.
2. From the task selection bar, select **Advanced**.
3. Expand **Plug-in**. Entries appear in the left panel.
4. To enable a plug-in management configuration entry, select it. The Plug-in Management tab appears in the right pane.
5. Select **Plug-in Enable**.
6. Click **Apply**.

7. When you have finished entering the values, select **OK**. The plug-in you just created is now listed on the left side of the page.

Editing a Plug-in by Using Oracle Directory Services Manager

To edit a plug-in entry:

1. From the task selection bar, select **Advanced**.
2. Expand **Plug-in**. Entries appear in the left panel.
3. To modify a plug-in management configuration entry, select it.
4. Enter changes to Mandatory Properties and Optional Properties on the right side of the page.
5. Click **Apply**.

Deleting a Plug-in by Using Oracle Directory Services Manager

To delete a plug-in:

1. From the task selection bar, select **Advanced**.
2. Expand **Plug-in**. Entries appear in the left panel.
3. Select the plug-in entry you want to delete.
4. Click the **Delete** icon. The plug-in entry you deleted no longer appears in the list.

Configuring a Customized External Authentication Plug-in

You can store user security credentials in a repository other than Oracle Internet Directory—for example, a database or another LDAP directory—and use these credentials for user authentication to Oracle components. You do not need to store the credentials in Oracle Internet Directory and then worry about keeping them synchronized. Authenticating a user by way of credentials stored in an external repository is called external authentication.

This chapter contains these topics:

- [Introduction to Configuring a Customized External Authentication Plug-in](#)
- [Installing, Configuring, and Enabling the External Authentication Plug-in](#)
- [Debugging the External Authentication Plug-in](#)
- [Creating the PL/SQL Package `oidexaup.sql`](#)

Note: All references to Oracle Single Sign-On in this chapter refer to Oracle Single Sign-On 10g (10.1.4.3.0) or later.

Introduction to Configuring a Customized External Authentication Plug-in

Authentication that relies on security credentials stored in Oracle Internet Directory is called native authentication. When a user enters her security credentials, the directory server compares them with the credentials stored in Oracle Internet Directory. If the credentials match, then the directory server authenticates the user.

By contrast, authentication that relies on security credentials stored in a directory other than Oracle Internet Directory is called external authentication. When a user enters her security credentials, the directory server compares them with the credentials stored in the other directory. This is done by using:

- A PL/SQL program that does the external authentication work
- An external authentication plug-in that invokes this PL/SQL program

Installing, Configuring, and Enabling the External Authentication Plug-in

This example uses the PL/SQL program, `oidexaup.sql`. "[Creating the PL/SQL Package `oidexaup.sql`](#)" on page 44-3 describes this program. This package is used for installing the external authentication plug-in PL/SQL package. It contains:

- Two plug-ins: namely, `when_compare_replace` and `when_modify_replace`

- One utility function: namely, `get_nickname`

The integrated package is the plug-in package, `OIEXTAUTH`. It can also serve as a template to modify according to the requirements of your deployment.

To install, configure, and enable the external authentication plug-in, follow these steps:

1. Implement your standalone external authentication PL/SQL program. For example, if you want to authenticate users by using user names and passwords, then you should have a PL/SQL program which takes these two parameters.

In our sample code, `oidexaup.sql`, `auth_external` is the program package name, and `authenticate_user` is the function that does the authentication. You must make sure that this standalone program is working properly before you move on to next steps.

2. Integrate this standalone program into the plug-in modules.
3. Load the plug-in package into database. In this example, we enter:

```
sqlplus ods/odspwd @oidexaup.sql
```

4. Register the plug-ins. Do this by creating and uploading an LDIF file that provides the directory server with the necessary information to invoke the plug-in.
5. This example uses a file named `oidexauth.ldif`, which contains the following:

```
dn: cn=whencompare,cn=plugin,cn=subconfigsubentry
objectclass:orclPluginConfig
objectclass:top
orclpluginname:oidextauth
orclplugintype:configuration
orclplugintiming:when
orclpluginldapoperation:ldapcompare
orclpluginenable:1
orclpluginversion:1.0.1
orclPluginIsReplace:1
cn:whencompare
orclpluginsubscriberdnlist:dc=com;o=IMC,c=US
orclpluginattributelist:userpassword
orclpluginrequestgroup:$prgdn
```

```
dn: cn=whenmodify,cn=plugin,cn=subconfigsubentry
objectclass:orclPluginConfig
objectclass:top
orclpluginname:oidextauth
orclplugintype:configuration
orclplugintiming:when
orclpluginldapoperation:ldapmodify
orclpluginenable:1
orclpluginversion:1.0.1
orclPluginIsReplace:1
cn:whenmodify
orclpluginsubscriberdnlist:dc=com;o=IMC,c=US
orclpluginattributelist:userpassword
orclpluginrequestgroup:$prgdn
```

In this file, we notify the directory server that, whenever there is an `ldapcompare` or `ldapmodify` request, there are two plug-ins to be invoked.

We use `orclpluginsubscriberdnlist:dc=com;o=IMC,c=US` so that plug-ins are ONLY invoked if the target entry is under `dc=com` or `o=IMC,c=US`.

Replace `$prgdn` with the plug-in request group DN. This is an optional, recommended security feature. For integrating with Oracle Single Sign-On, this value is a required field. Only members of the group entered can invoke the plug-ins. You may enter multiple groups. Use a semicolon to separate entries.

The recommended defaults are:

```
cn=OracleUserSecurityAdmins, cn=Groups, cn=OracleContext and
cn=OracleDASAdminGroup, cn=Groups, cn=OracleContext, o=default_
subscriber, dc=com. Note that the Oracle Single Sign-On server is a member of
the first group. Also, be sure to replace o=default_subscriber with the correct
value for your deployment environment.
```

To add this file to the directory, enter the following:

```
ldapadd -p portnum -h hostname -D cn=orcladmin -q -v \
-f oidexauth.ldif
```

Now, everything should be ready. Use the `ldapcompare` command-line tool to verify that the plug-in and authentication program are working properly before you try to authenticate the user from Oracle Single Sign-On.

In our example, we also provide the plug-in code for externally modifying user password.

Debugging the External Authentication Plug-in

Turn on directory server plug-in to help you to examine the process and content of plug-ins.

To setup directory server plug-in debugging, execute the following command:

```
sqlplus ods @$ORACLE_HOME/ldap/admin/oidspdsu.sql
```

To enable directory server plug-in debugging, execute the following command:

```
sqlplus ods @$ORACLE_HOME/ldap/admin/oidspdon.sql
```

To disable directory server plug-in debugging, execute the following command:

```
sqlplus ods @$ORACLE_HOME/ldap/admin/oidspdof.sql
```

To show directory server plug-in debugging messages, execute the following command:

```
sqlplus ods @$ORACLE_HOME/ldap/admin/oidspdsh.sql
```

To delete directory server plug-in debugging messages, please execute the following command:

```
sqlplus ods @$ORACLE_HOME/ldap/admin/oidspdde.sql
```

Creating the PL/SQL Package oidexaup.sql

The script `oidexaup.sql`, as used in this example, contains the following:

```
CREATE OR REPLACE PACKAGE OIDEXTAUTH AS

  PROCEDURE when_compare_replace (ldapplugincontext IN ODS.plugincontext,
                                result              OUT INTEGER,
                                dn                  IN VARCHAR2,
                                attrname            IN VARCHAR2,
                                attrval            IN VARCHAR2,
```

```

        rc                OUT INTEGER,
        errormsg          OUT VARCHAR2
    );

PROCEDURE when_modify_replace (ldapplugincontext IN ODS.plugincontext,
                               dn                IN VARCHAR2,
                               mods              IN ODS.modlist,
                               rc                OUT INTEGER,
                               errormsg         OUT VARCHAR2
    );

FUNCTION get_nickname (dn          IN VARCHAR2,
                      my_session IN DBMS_LDAP.session)
    RETURN VARCHAR2;

END OIDEXTAUTH;
/

SHOW ERROR

CREATE OR REPLACE PACKAGE BODY OIDEXTAUTH AS

    -- We use this function to convert the dn to nickname.
    -- When OID server receives the ldapcompare request, it
    -- only has the dn information. We need to use DBMS_LDAP_UTL
    -- package to find out the nickname attribute value of
    -- the entry.

FUNCTION get_nickname (dn          IN VARCHAR2,
                      my_session IN DBMS_LDAP.session)
    RETURN VARCHAR2
IS
    my_pset_coll      DBMS_LDAP_UTL.PROPERTY_SET_COLLECTION;
    my_property_names DBMS_LDAP.STRING_COLLECTION;
    my_property_values DBMS_LDAP.STRING_COLLECTION;

    user_handle       DBMS_LDAP_UTL.HANDLE;
    user_id            VARCHAR2(2000);
    user_type          PLS_INTEGER;
    user_nickname      VARCHAR2(256) DEFAULT NULL;

    my_attrs           DBMS_LDAP.STRING_COLLECTION;
    retval             PLS_INTEGER;

BEGIN
    plg_debug( '=== Beginning of get_nickname() === ');
    user_type      := DBMS_LDAP_UTL.TYPE_DN;
    user_id        := dn;

    retval := DBMS_LDAP_UTL.create_user_handle(user_handle, user_type, user_id);

    plg_debug('create_user_handle() Returns ' || To_char(retval));

    retval := DBMS_LDAP_UTL.get_user_properties(my_session,
                                                user_handle,
                                                my_attrs,
                                                DBMS_LDAP_UTL.NICKNAME_PROPERTY,
                                                my_pset_coll);

    plg_debug( 'get_user_properties() Returns ' || To_char(retval));

```

```

IF my_pset_coll.COUNT > 0 THEN
  FOR i IN my_pset_coll.first .. my_pset_coll.last LOOP
    retval := DBMS_LDAP_UTL.get_property_names(my_pset_coll(i),
                                              my_property_names);
    IF my_property_names.COUNT > 0 THEN
      FOR j IN my_property_names.first .. my_property_names.last LOOP
        retval := DBMS_LDAP_UTL.get_property_values(my_pset_coll(i),
                                                    my_property_names(j),
                                                    my_property_values);
        IF my_property_values.COUNT > 0 THEN
          FOR k IN my_property_values.FIRST..my_property_values.LAST
LOOP
            user_nickname := my_property_values(k);
            plg_debug( 'user nickname = ' || user_nickname);
          END LOOP;
        END IF;
      END LOOP;
    END IF; -- IF my_property_names.count > 0
  END LOOP;
END IF; -- If my_pset_coll.count > 0

plg_debug( 'got user_nickname: ' || user_nickname);

-- Free my_properties
IF my_pset_coll.count > 0 then
  DBMS_LDAP_UTL.free_propertysset_collection(my_pset_coll);
END IF;

DBMS_LDAP_UTL.free_handle(user_handle);

RETURN user_nickname;

EXCEPTION
  WHEN OTHERS THEN
    plg_debug('Exception in get_nickname. Error code is ' || to_
char(sqlcode));
    plg_debug(' ' || Sqlerrm);
    RETURN NULL;
END;

PROCEDURE when_compare_replace (ldapplugincontext IN ODS.plugincontext,
                               result             OUT INTEGER,
                               dn                 IN VARCHAR2,
                               attrname          IN VARCHAR2,
                               attrval          IN VARCHAR2,
                               rc                OUT INTEGER,
                               errormsg         OUT VARCHAR2
                               )
IS
  retval pls_integer;
  lresult BOOLEAN;

  my_session      DBMS_LDAP.session;
  my_property_names DBMS_LDAP.STRING_COLLECTION;
  my_property_values DBMS_LDAP.STRING_COLLECTION;
  my_attrs        DBMS_LDAP.STRING_COLLECTION;
  my_pset_coll    DBMS_LDAP_UTL.PROPERTY_SET_COLLECTION;
  user_handle     DBMS_LDAP_UTL.HANDLE;

```

```

        user_id          VARCHAR2(2000);
        user_type        PLS_INTEGER;
        user_nickname    VARCHAR2(60);
        remote_dn        VARCHAR2(256);

        i                PLS_INTEGER;
        j                PLS_INTEGER;
        k                PLS_INTEGER;

BEGIN
    plg_debug( '=== Begin of WHEN-COMPARE-REPLACE plug-in');
    plg_debug( 'DN = ' || dn);
    plg_debug( 'Attr = ' || attrname);
    --plg_debug( 'Attrval = ' || attrval);

    DBMS_LDAP.USE_EXCEPTION := FALSE;
    errormsg := 'No error msg';
    rc := 0;

    -- converting dn to nickname
    my_session := LDAP_PLUGIN.init(ldapplugincontext);
    plg_debug( 'ldap_session = ' || RAWTOHEX(SUBSTR(my_session,1,8)));

    retval := LDAP_PLUGIN.simple_bind_s(ldapplugincontext, my_session);
    plg_debug( 'simple_bind_res = ' || TO_CHAR(retval));

    user_nickname := get_nickname(dn, my_session);
    plg_debug( 'user_nickname = ' || user_nickname);

    -- unbind from the directory
    retval := DBMS_LDAP.unbind_s(my_session);
    plg_debug( 'unbind_res Returns ' || To_char(retval));

    IF (user_nickname IS NULL) THEN
        result := 32;
        errormsg := 'Can''t find the nickname';
        plg_debug( 'Can''t find the nickname');
        RETURN;
    END IF;

    plg_debug( '=== Now go to extauth ');

    BEGIN
        retval := auth_external.authenticate_user(user_nickname, attrval);
        plg_debug( 'auth_external.authenticate_user() returns = ' || 'True');
        result := 6; -- compare result is TRUE
    EXCEPTION
        WHEN OTHERS THEN
            result := 5; -- compare result is FALSE
            plg_debug( 'auth_external.authenticate_user() returns = ' || 'False');
            RETURN;
    END;

    plg_debug( '=== End of WHEN-COMPARE-REPLACE plug-in');
EXCEPTION
    WHEN OTHERS THEN
        rc := 1;
        errormsg := 'Exception: when_compare_replace plugin';
        plg_debug( 'EXCEPTION: ' || retval);

```



```

        plg_debug('Exception in when_compare. Error code is ' || to_
char(sqlcode));
        plg_debug(' ' || Sqlerrm);
END;

PROCEDURE when_modify_replace (ldapplugincontext IN ODS.plugincontext,
                               dn                IN VARCHAR2,
                               mods              IN ODS.modlist,
                               rc                OUT INTEGER,
                               errormsg         OUT VARCHAR2
                               )
IS
    retval pls_integer;
    lresult BOOLEAN;

    my_session          DBMS_LDAP.SESSION;
    my_property_names   DBMS_LDAP.STRING_COLLECTION;
    my_property_values  DBMS_LDAP.STRING_COLLECTION;
    my_attrs             DBMS_LDAP.STRING_COLLECTION;
    my_modval           DBMS_LDAP.BERVAL_COLLECTION;
    my_pset_coll        DBMS_LDAP_UTL.PROPERTY_SET_COLLECTION;
    user_handle         DBMS_LDAP_UTL.HANDLE;

    l_mod_array         RAW(32);
    user_id             VARCHAR2(2000);
    user_type           PLS_INTEGER;
    user_nickname       VARCHAR2(2000);
    old_passwd          VARCHAR2(60) DEFAULT NULL;
    new_passwd          VARCHAR2(60) DEFAULT NULL;
    remote_dn           VARCHAR2(256);

    i                   PLS_INTEGER;
    j                   PLS_INTEGER;
    k                   PLS_INTEGER;

BEGIN
    plg_debug( '=== Begin of WHEN-MODIFY-REPLACE plug-in');
    DBMS_LDAP.USE_EXCEPTION := FALSE;
    user_type      := DBMS_LDAP_UTL.TYPE_DN;
    user_id       := dn;

    -- converting dn to nickname
    my_session := LDAP_PLUGIN.init(ldapplugincontext);
    plg_debug( 'ldap_session = ' || RAWTOHEX(SUBSTR(my_session,1,8)));

    retval := LDAP_PLUGIN.simple_bind_s(ldapplugincontext, my_session);
    plg_debug( 'simple_bind_res = ' || TO_CHAR(retval));

    user_nickname := get_nickname(dn, my_session);
    plg_debug( 'user_nickname = ' || user_nickname);

    -- unbind from the directory
    retval := DBMS_LDAP.unbind_s(my_session);

    FOR l_counter1 IN 1..mods.COUNT LOOP
        IF (mods(l_counter1).operation = 2) AND
            (mods(l_counter1).type = 'userpassword') THEN

            FOR l_counter2 IN 1..mods(l_counter1).vals.COUNT LOOP

```

```

        new_passwd := mods(l_counter1).vals(l_counter2).val;
    END LOOP;
END IF;

IF (mods(l_counter1).operation = 0) AND
(mods(l_counter1).type = 'userpassword') THEN

    FOR l_counter2 IN 1..mods(l_counter1).vals.COUNT LOOP
        new_passwd := mods(l_counter1).vals(l_counter2).val;
    END LOOP;
END IF;

IF (mods(l_counter1).operation = 1) AND
(mods(l_counter1).type = 'userpassword') THEN

    FOR l_counter2 IN 1..mods(l_counter1).vals.COUNT LOOP
        old_passwd := mods(l_counter1).vals(l_counter2).val;
    END LOOP;
END IF;
END LOOP;

IF new_passwd IS NOT NULL AND old_passwd IS NOT NULL THEN
BEGIN
    auth_external.change_passwd(user_nickname, old_passwd, new_passwd);
EXCEPTION
    WHEN OTHERS THEN
        rc := 1;
        plg_debug( 'auth_external.change_passwd() raised exception. ');
        errormsg := 'auth_external.change_passwd() raised exception. ';
        RETURN;
END;
ELSIF new_passwd IS NOT NULL AND old_passwd IS NULL THEN
BEGIN
    auth_external.reset_passwd(user_nickname, new_passwd);
EXCEPTION
    WHEN OTHERS THEN
        plg_debug( 'auth_external.reset_passwd() raised exception. ');
        rc := 1;
        errormsg := 'auth_external.reset_passwd() raised exception. ';
        RETURN;
END;
ELSE
    rc := 1;
    errormsg := 'PLG_Exception. Not enough info to change passwd. ';
END IF;

plg_debug( 'external change password succeed');
rc := 0;
errormsg := 'No when_mod_replace plguin error msg';

retval := DBMS_LDAP.unbind_s(my_session);

plg_debug( 'End of WHEN-MODIFY-REPLACE');
--COMMIT;
EXCEPTION
    WHEN others THEN
        rc := 1;
        errormsg := 'PLG_Exception: when_modify_replace plguin';
        plg_debug('Exception in when_modify. Error code is ' || to_char(sqlcode));
        plg_debug(' ' || Sqlerrm);

```

```
END;  
  
END OIEXTAUTH;  
/  
SHOW ERRORS  
--list  
  
EXIT;
```

Part VII

Appendixes

This part contains these appendixes:

- [Appendix A, "Differences Between 10g and 11g"](#)
- [Appendix B, "Managing Oracle Internet Directory Instances by Using OIDCTL"](#)
- [Appendix C, "Setting Up Oracle Database Advanced Replication-Based Replication"](#)
- [Appendix D, "How Replication Works"](#)
- [Appendix E, "Java Server Plug-in Developer's Reference"](#)
- [Appendix F, "PL/SQL Server Plug-in Developer's Reference"](#)
- [Appendix G, "The LDAP Filter Definition"](#)
- [Appendix H, "The Access Control Directive Format"](#)
- [Appendix I, "Globalization Support in the Directory"](#)
- [Appendix J, "Setting up Access Controls for Creation and Search Bases for Users and Groups"](#)
- [Appendix K, "Searching the Directory for User Certificates"](#)
- [Appendix L, "Adding a Directory Node by Using the Database Copy Procedure"](#)
- [Appendix M, "Oracle Authentication Services for Operating Systems"](#)
- [Appendix N, "RFCs Supported by Oracle Internet Directory"](#)
- [Appendix O, "Managing Oracle Directory Services Manager's Java Key Store"](#)
- [Appendix P, "Starting and Stopping the Oracle Stack"](#)
- [Appendix Q, "Performing a Rolling Upgrade"](#)
- [Appendix R, "Troubleshooting Oracle Internet Directory"](#)

Differences Between 10g and 11g

This appendix lists the major differences between Oracle Internet Directory Release 10g (10.1.4.0.1) and 11g Release 1 (11.1.1). It contains the following topics:

- [Instance Creation and Process Management](#)
- [Locations of Configuration Attributes](#)
- [Enabling Server Debugging](#)
- [Command Line Tools](#)
- [Path Names](#)
- [Graphical User Interfaces](#)
- [Audit](#)
- [Referential Integrity](#)
- [Server Chaining](#)
- [Replication](#)
- [Oracle Directory Integration Platform](#)
- [Oracle Single Sign-On and Oracle Delegated Administration Services](#)
- [Java Containers](#)

Instance Creation and Process Management

10g Oracle Internet Directory Instance Creation

In 10g (10.1.4.0.1) and earlier releases, configuration information for an instance of Oracle Internet Directory was stored in a configuration set, which had a DN of the form:

```
cn=configsetN,cn=osldapd,cn=subconfigsubentry
```

where N is an integer. You created a new Oracle Internet Directory instance by creating a new `configsetN` entry and then executing:

```
oidctl connect=connStr config=N inst=InstNum flags="..." start
```

to start the instance.

11g Oracle Internet Directory Instance Creation

In 11g Release 1 (11.1.1), the procedure for creating an instance has changed. Configuration information for an Oracle Internet Directory instance now resides in an instance-specific configuration entry, which has a DN of the form

```
cn=componentname,cn=osldldapd,cn=subconfigsentry
```

where `componentname` is the name of a Oracle Fusion Middleware system component of `Type=OID`, for example, `oid1`. You do not manually create an instance-specific configuration entry. Instead, you create a Oracle Fusion Middleware component of `Type=OID`. Creating the Oracle Internet Directory component automatically generates an instance-specific configuration entry.

Note: The entry in `configset0` still exists in 11g, but it is read-only and used to store default attribute values for seeding new instance-specific configuration entries.

The first Oracle Internet Directory system component is created during installation. The first Oracle Internet Directory system component, `oid1` by default, is created during installation with the Oracle instance name `asinst_1` by default. The corresponding configuration entry for this component is `cn=oid1,cn=osldldapd,cn=subconfigsentry`. There are two ways to create an additional Oracle Internet Directory instance:

- Adding another component of `Type=OID` by using `opmnctl createcomponent`. For example:

```
opmnctl createcomponent -componentType OID \
  -componentName componentName -Db_info "DBHostName:Port:DBSvcName" \
  -Namespace "dc=domain"
```

See ["Creating an Oracle Internet Directory Component by Using opmnctl"](#) on page 8-6 for more information.

- Adding an Oracle Internet Directory instance within an existing component of `Type=OID` by using `oidctl add`. See ["Creating and Starting an Oracle Internet Directory Server Instance by Using OIDCTL"](#) on page B-3 for more information.

The recommended method is to use `opmnctl` to add a system component. If you create an instance by adding a component with `opmnctl`, you must use `opmnctl` or Oracle Enterprise Manager Fusion Middleware Control, not `oidctl`, to stop and start the instance. See ["Starting the Oracle Internet Directory Server by Using opmnctl"](#) on page 8-9 and ["Starting the Oracle Internet Directory Server by Using Fusion Middleware Control"](#) on page 8-5.

You can update the configuration attributes of the instance by using Fusion Middleware Control, LDAP tools, or Oracle Directory Services Manager. See [Chapter 9, "Managing System Configuration Attributes."](#)

If you use `opmnctl` to add a system component with `oid2` as the component name, then an additional instance with `componentname=oid2` is configured within the given Oracle instance, which is `asinst_1` by default. This instance of Oracle Internet Directory can be started and stopped by using the `opmnctl` command with `ias-component=oid2` or by using Fusion Middleware Control. The instance-specific configuration entry for this instance is `cn=oid2,cn=osldldapd,cn=subconfigsentry` and the configuration attributes in that entry can be updated to customize the instance. For more information about

instance-specific configuration attributes, see ["Attributes of the Instance-Specific Configuration Entry"](#) on page 9-2.

Note: You can use `oidctl` to create an instance if you are running Oracle Internet Directory as a standalone server, not part of a WebLogic domain. When you create an instance with `oidctl`, you must use `oidmon` and `oidctl` to stop and start the instance. An Oracle Internet Directory instance created with `oidctl` cannot be registered with a WebLogic server, so you cannot use Oracle Enterprise Manager Fusion Middleware Control to manage the instance. See [Appendix B, "Managing Oracle Internet Directory Instances by Using OIDCTL."](#)

11g Replication Server

Use `oidctl` or Oracle Enterprise Manager Fusion Middleware Control to start replication on an instance the first time. After that, `opmnctl` stops and starts replication when it stops and starts the component. If you must stop and start the Oracle Internet Directory Replication Server for administration purposes, use `oidctl` or Oracle Enterprise Manager Fusion Middleware Control.

11g OIDMON

In 11g Release 1 (11.1.1), OIDMON monitors and reports the status of all Oracle Internet Directory processes (dispatcher, directory server, and replication server) to OPMN. This monitoring by OIDMON enables Fusion Middleware Control to report Oracle Internet Directory status accurately.

See Also:

- [Chapter 4, "Understanding Process Control of Oracle Internet Directory Components"](#)
- [Chapter 8, "Managing Oracle Internet Directory Instances."](#)

Locations of Configuration Attributes

Oracle Internet Directory configuration information is stored in configuration attributes in the DIT. For a complete listing of configuration attributes, their locations, and procedures for managing them, see [Chapter 9, "Managing System Configuration Attributes."](#)

In 10g (10.1.4.0.1), many configurable Oracle Internet Directory attributes resided in the DSE Root and in the `configset` entry, for example, `cn=configset0`, `cn=osdldapd`, `cn=subconfigsubentry`. In 11g Release 1 (11.1.1), most of these have been moved to the instance-specific configuration entry or the DSA configuration entry.

Most attributes that resided in the instance-specific configuration set at 10g (10.1.4.0.1) are now stored in the instance-specific configuration entry in 11g Release 1 (11.1.1). In addition, some attributes that resided in the DSA configuration entry are now instance-specific and have been moved to the instance-specific configuration entry.

Notes:

- During an upgrade to 11g, attributes are created in their new locations with default values. An attribute's value prior to the upgrade is not preserved unless the attribute is in the same location in 11g.
- If you manage attributes from the command line, ensure that the DNs specified on the command line or in LDIF files reflect the 11g locations of the attributes.

Table A-1 lists 10g attributes, their locations in 10g and in 11g, and their default values in 11g. In the following table, "Instance Specific" implies that the attribute is located in the instance-specific configuration entry, for example `cn=oid1`, `cn=osldapd`, `cn=subconfigsubentry` and DSA Config is `cn=dsaconfig`, `cn=configsets`, `cn=oracle internet directory`. Attributes in the DSA Config entry are shared by all Oracle Internet Directory instances and components.

Table A-1 New Locations of 10g Attributes

Attribute	10g Location	11g Location	11g Default Value
<code>orclanonymousbindsflag</code>	Root DSE	Instance Specific	1
<code>orcldataprivacymode</code>	DSA Config	DSA Config	0
<code>orcldebugflag</code>	Root DSE	Instance Specific	0
<code>orcldebugforceflush</code>	DSA Config	Instance Specific	0
<code>orcldebugop</code>	Root DSE	Instance Specific	511
<code>orclcacheenabled</code>	Root DSE	Instance Specific	1
<code>orclcachemaxentries</code>	Root DSE	Instance Specific	100000
<code>orclcachemaxentsize</code>	DSA Config	Instance Specific	1000000
<code>orclcachemaxsize</code>	Root DSE	Instance Specific	200000000
<code>orclenablegroupcache</code>	Root DSE	Instance Specific	1
<code>orcleventlevel</code>	Root DSE	Instance Specific	0
<code>orclldapconntimeout</code>	DSA Config	Instance Specific	0
<code>orclmatchdnenabled</code>	Root DSE	DSA Config	1
<code>orclmaxcc</code>	Configset	Instance Specific	2
<code>orclmaxconnincache</code>	DSA Config	Instance Specific	100000
<code>orclnwrwtimeout</code>	DSA Config	Instance Specific	30
<code>orcloptcontainsquery</code>	Root DSE	DSA Config	0
<code>orcloptracklevel</code>	DSA Config	Instance Specific	0
<code>orcloptrackmaxtotalsize</code>	DSA Config	Instance Specific	100000000
<code>orclpkimatchingrule</code>	DSA Config	DSA Config	2
<code>orclrefreshdgrmems</code>	DSA Config	DSA Config	0

Table A-1 (Cont.) New Locations of 10g Attributes

Attribute	10g Location	11g Location	11g Default Value
orclsslauthenticationmode	Configset	Instance Specific	auth-conf
orclsslcipherchoice	Configset	Instance Specific	Rc4-56, des, 3des, rc4, rc4-40
orclsslmechanism	Configset	Instance Specific	DIGEST MD5, EXTERNAL
orclsdumpflag	DSA Config	Instance Specific	0
orclservermode	Root DSE	Instance Specific	rw
orclserverprocs	Configset	Instance Specific	1
orclssizelimit	Root DSE	Instance Specific	10000
orclsskewedattribute	DSA Config	DSA Config	objectclass
orclsskiprefinsql	DSA Config	DSA Config	0
orclsslauthentication	Configset	Instance Specific	1
orclsslenable	Configset	Instance Specific	0
orclsslversion	Configset	Instance Specific	3
orclsslwalleturl	Configset	Instance Specific	File:
orclstatsdn	DSA Config	DSA Config	
orclstatsflag	Root DSE	Instance Specific	1
orclstatslevel	Root DSE	Instance Specific	0
orclstatsperiodicity	DSA Config	Instance Specific	30
orcltimelimit	Root DSE	Instance Specific	3600
orcltlimitmode		DSA Config	1

See Also: [Chapter 9, "Managing System Configuration Attributes"](#).

Default Ports

During installation of Oracle Internet Directory, Oracle Identity Management 11g Installer follows specific steps in assigning the SSL and non-SSL port. First, it attempts to use 3060 as the non-SSL port. If that port is unavailable, it tries ports in the range 3061 to 3070, then 13060 to 13070. Similarly, it attempts to use 3131 as its SSL port, then ports in the range 3132 to 3141, then 13131 to 13141.

If you want Oracle Internet Directory to use privileged ports, you can override the defaults during installation by using `staticports.ini`. (See *Oracle Fusion Middleware Installation Guide for Oracle Identity Management*.) You can also reset the port numbers after installation. See ["Enabling Oracle Internet Directory to run on Privileged Ports"](#) on page 7-3.

Note: If you perform an upgrade from an earlier version of Oracle Internet Directory to 11g Release 1 (11.1.1), your port numbers from the earlier version are retained.

Enabling Server Debugging

In 10g, you could enable debugging either by using a debug option when you invoked the server or by setting `orcldebugflag`, which was in the root DSE.

In 11g, you cannot enable debugging by using debug options when you invoke the server. You enable debugging of the directory server by changing the attribute `orcldebugflag`, which is now in the instance-specific configuration entry, which has a DN of the form:

```
cn=componentname,cn=osldlapd,cn=subconfigsentry
```

You can change `orcldebugflag` either by using the Server Properties page, Logging tab, in Fusion Middleware Control or by using `ldapmodify`. For example, you could use the following LDIF file to configure the Oracle Internet Directory instance in system component `oid1` for heavy trace debugging.

```
dn: cn=oid1,cn=osldlapd,cn=subconfigsentry
changetype: modify
replace: orcldebugflag
orcldebugflag: 1
```

See [Chapter 23, "Managing Logging"](#) for more information.

You enable debugging of the replication server by changing the attribute `orcldebuglevel` in the replication configuration set

[Table 40–4, "Replication Configuration Set Attributes"](#) lists and describes the attributes of the replication configuration set, which has the following DN:

```
cn=configset0,cn=osdrepld,cn=subconfigsentry
```

You can use either `ldapmodify` or the Shared Properties, Replication tab, in Fusion Middleware Control to change `orcldebuglevel`. See [Chapter 40, "Managing Replication Configuration Attributes"](#) for more information.

Command Line Tools

Most commands now require that the environment variable `ORACLE_INSTANCE` be set.

New options have been added to `opmnctl` and `oidctl`.

Several Oracle Internet Directory administration tools and bulk tools take a `connect` argument that specifies the Oracle Database to connect to. In 10g, if you did not include a `connect` argument on the command line, the command would take the value of the environment variable `ORACLE_SID` by default. In 11g Release 1 (11.1.1), you must use the `connect` argument to specify the database. Oracle Internet Directory and Oracle Database are not installed in the same `ORACLE_HOME`, so `ORACLE_SID` is irrelevant. Therefore, you must use the `connect` argument to specify the database, for example `connect=oiddb`.

See Also:

- [Chapter 8, "Managing Oracle Internet Directory Instances"](#)
- [Chapter 15, "Performing Bulk Operations"](#)

Path Names

In Oracle Fusion Middleware 11g Release 1 (11.1.1), files that are updatable are installed under `ORACLE_INSTANCE` and most product binaries are stored under `ORACLE_HOME`. As a result, the path names of most configuration files and log files are different than in 10g (10.1.4.0.1). [Table A-2](#) lists some examples:

Table A-2 Some Path Names that Changed

Filename	10g (10.1.4.0.1) Location	11g Release 1 (11.1.1) Location
<code>Orclpwdlldap1</code>	<code>ORACLE_HOME/ldap/admin</code>	<code>ORACLE_INSTANCE/OID/admin</code>
<code>OidpwdrSID</code>		
<code>Tnsnames.ora</code>	<code>ORACLE_HOME/network/admin</code>	<code>ORACLE_HOME/config</code>
<code>Oidldapd*.log</code>	<code>ORACLE_HOME/ldap/log</code>	<code>ORACLE_HOME/diagnostics/logs/OID/componentName</code>
<code>oidmon*.log</code>		
<code>bulkload.log</code>	<code>ORACLE_HOME/ldap/log</code>	<code>ORACLE_HOME/diagnostics/logs/OID/tools</code>
<code>bulkdelete.log</code>		
<code>catalog.log</code>		
<code>Bulkload intermediate files</code>	<code>ORACLE_HOME/ldap/load</code>	<code>ORACLE_HOME/OID/load</code>
<code>opmnctl</code>	<code>ORACLE_HOME/opmn/bin</code>	<code>ORACLE_INSTANCE/bin</code>
<code>opmn.xml</code>	<code>ORACLE_HOME/opmn/conf</code>	<code>ORACLE_INSTANCE/config/OPMN/opmn</code>

See Also: [Chapter 2, "Understanding Oracle Internet Directory in Oracle Fusion Middleware"](#)

Graphical User Interfaces

Oracle Directory Manager and Oracle Internet Directory Grid Control Plug-in no longer exist in 11g Release 1 (11.1.1). They have been replaced by Oracle Directory Services Manager and Oracle Enterprise Manager Fusion Middleware Control.

See the following sections for more information:

- ["Using Oracle Directory Services Manager"](#) on page 7-5
- ["Using Fusion Middleware Control to Manage Oracle Internet Directory"](#) on page 7-4

Audit

As of release 11g Release 1 (11.1.1), Oracle Internet Directory uses an audit framework that is integrated with Oracle Fusion Middleware.

You can configure auditing by using Oracle Enterprise Manager Fusion Middleware Control or the WebLogic Scripting Tool, `wlst`.

The attribute `orclAudFilterPreset` has replaced the audit levels used in 10g (10.1.4.0.1). You can set it to `None`, `Low`, `Medium`, `All`, or `Custom`.

There is no longer any need for an Oracle Internet Directory garbage collector.

See Also: [Chapter 22, "Managing Auditing."](#)

Referential Integrity

Referential Integrity has been completely reimplemented. You can configure it from the command line or by using Oracle Enterprise Manager Fusion Middleware Control.

See Also: [Chapter 21, "Configuring Referential Integrity"](#)

Server Chaining

Server chaining now supports Novell eDirectory, as well as Microsoft Active Directory and Sun Java System Directory Server, formerly known as SunONE iPlanet. The attributes `mapUIDtoADAttribute`, `showExternalGroupEntries`, `showExternalUserEntries`, and `addOrcluserV2ToADUsers` have been added since Oracle Internet Directory 10g (10.1.4.0.1).

Replication

You can set up and manage LDAP-based replication by using the replication wizard in Oracle Enterprise Manager Fusion Middleware Control. A separate Replication page enables you to adjust attributes that control the replication server.

You can now use LDAP-based replication for multimaster directory replication groups. You no longer need Oracle Database Advanced Replication-based replication for this purpose. If you want to replicate Oracle Single Sign-On, however, you still must use Oracle Database Advanced Replication-based replication.

See Also:

- [Chapter 6, "Understanding Oracle Internet Directory Replication"](#)
- [Part V, "Advanced Administration: Directory Replication"](#)
- [Appendix C, "Setting Up Oracle Database Advanced Replication-Based Replication"](#)

Oracle Directory Integration Platform

In 10g (10.1.4.0.1), the Oracle Directory Integration Platform server was under the control of OIDMON, like the LDAP and replication servers. For 11g Release 1 (11.1.1), Oracle Directory Integration Platform has been reimplemented as a J2EE application, and is started and stopped separately from Oracle Internet Directory servers.

See Also: *Oracle Fusion Middleware Administrator's Guide for Oracle Directory Integration Platform*

Oracle Single Sign-On and Oracle Delegated Administration Services

Oracle Fusion Middleware 11g Release 1 (11.1.1) does not include Oracle Single Sign-On or Oracle Delegated Administration Services. Oracle Internet Directory 11g Release 1 (11.1.1), however, is compatible with Oracle Single Sign-On 10g (10.1.4.3.0) or later and Oracle Delegated Administration Services 10g (10.1.4.3.0) or later.

Java Containers

In Oracle Application Server 10g, Java applications ran in instances of Oracle Containers for Java. In the current release, they run in instances of WebLogic. Oracle Directory Services Manager and Oracle Directory Integration Platform are Java components that run in WebLogic managed servers.

The Oracle Internet Directory LDAP and replication servers, as C programs, are system components and are not affected by this change. The Java server plug-ins run in a JVM within the `oidldapd` server itself. This is implemented using the Java Native Interface (JNI).

See Also:

- *Oracle Fusion Middleware Introduction to Oracle WebLogic Server*
- [Chapter 43, "Developing Plug-ins for the Oracle Internet Directory Server"](#)

Managing Oracle Internet Directory Instances by Using OIDCTL

This appendix contains the following sections:

- [Introduction to Managing Oracle Internet Directory by Using OIDCTL](#)
- [Creating and Starting an Oracle Internet Directory Server Instance by Using OIDCTL](#)
- [Stopping an Oracle Internet Directory Server Instance by Using OIDCTL](#)
- [Starting an Oracle Internet Directory Server Instance by Using OIDCTL](#)
- [Viewing Status Information by Using OIDCTL](#)
- [Deleting an Oracle Internet Directory Server Instance by Using OIDCTL](#)

See Also: "Starting an Instance of the Replication Server by Using OIDCTL" on page 8-10.

Introduction to Managing Oracle Internet Directory by Using OIDCTL

Some customers need to run Oracle Internet Directory in standalone mode, without a WebLogic domain or Oracle Enterprise Manager Fusion Middleware Control. If you are running Oracle Internet Directory in standalone mode, you can use `oidctl add` to create additional instances of Oracle Internet Directory within an existing Oracle Internet Directory component. If you create an Oracle Internet Directory instance by using `oidctl`, your new instance is not visible to a WebLogic server and you are not able to manage the instance by using Oracle Enterprise Manager Fusion Middleware Control.

The `inst` argument to `oidctl` is an integer. That is, the first server instance is 1 (`inst=1`) and the second is 2, and so forth.

[Figure B-1](#) shows a single Oracle Internet Directory component with two Oracle Internet Directory instances. Each instance has its own dispatcher with a non-SSL and an SSL port. Both dispatchers are controlled by the same OIDMON.

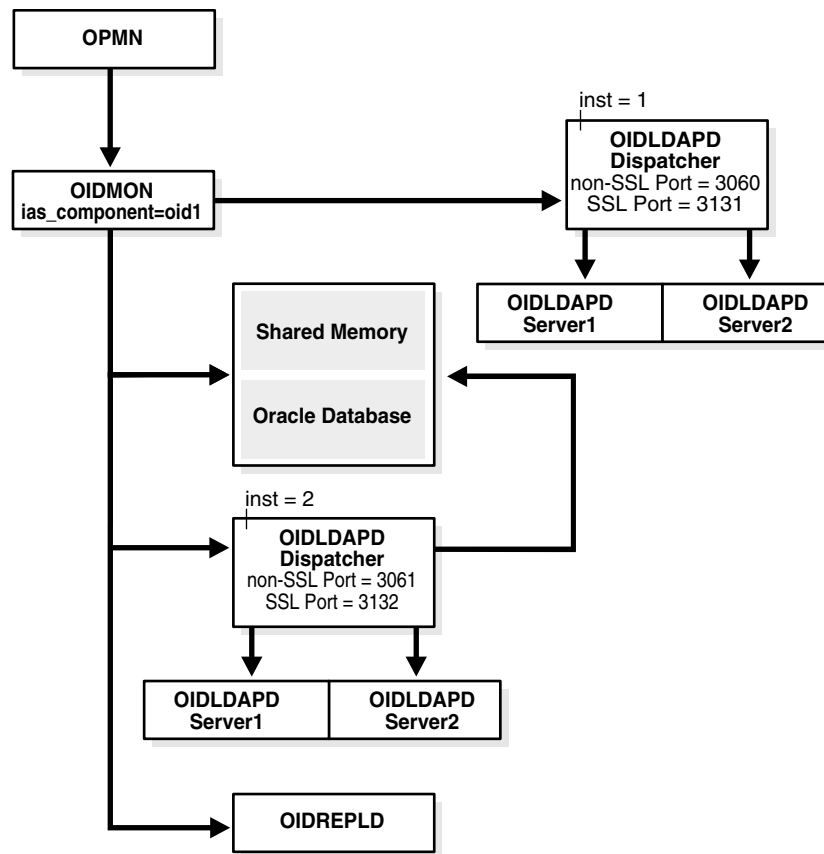
Figure B-1 A Component with Two Instances

Creating a new instance in this manner also creates a new instance-specific configuration entry with the new instance number appended to the component name. For example, if the first instance-specific configuration entry was:

```
cn=oid1,cn=osldlapd,cn=subconfigsentry
```

then the second instance-specific configuration entry is:

```
cn=oid1_2,cn=osldlapd,cn=subconfigsentry
```

You can manage the two instances independently by using LDAP tools or Oracle Directory Services Manager. The new instance cannot be registered with a WebLogic domain, so you cannot use Oracle Enterprise Manager Fusion Middleware Control or WLST to manage it.

Creating an Oracle Internet Directory instance in this manner does not generate any new pathnames in the file system. Instances that are part of the same Oracle Internet Directory component read from the same configuration files and write log files to the same log directory.

For backward compatibility, Oracle Internet Directory 11g Release 1 (11.1.1) also allows you to create an instance with default attribute values by using `oidctl add`.

Creating and Starting an Oracle Internet Directory Server Instance by Using OIDCTL

You can create another Oracle Internet Directory server instance within an existing component and start the server by using `oidctl add`. This command starts the server as well.

Notes:

- You must set the environment variables `ORACLE_INSTANCE` and `ORACLE_HOME` before you run the `oidctl` command.
 - If you do not specify the Oracle Internet Directory instance name and component name to `oidctl`, the command uses the default value `inst1` or `oid1` respectively. If you must specify different values, you can either set the environment variables `INSTANCE_NAME` and `COMPONENT_NAME`, or pass the instance name and component name in the command line as `name=instanceName, componentname=componentName`, respectively.
 - Best practice is to create new Oracle Internet Directory instances by creating new Oracle Internet Directory components, as described in [Chapter 8, "Managing Oracle Internet Directory Instances"](#). You should only use `oidctl` to create an instance if you plan to run Oracle Internet Directory in standalone mode and never use Oracle Enterprise Manager Fusion Middleware Control.
-
-

To create and start the server by using `oidctl add`, type:

```
oidctl connect=connect_string server=oidldapd inst=new_instance_number \
  name=instanceName componentname=componentName \
  flags="port=non_ssl_port sport=ssl_port" add
```

`oidctl add` creates the new configuration entry:

```
cn=componentName_new_instance_number,cn=osldapd,cn=subconfigsentry
```

Typically, the `inst` value of the original instance is 1, the second instance you create is 2, and so forth. For example:

```
oidctl connect=oiddb server=oidldapd inst=2 flags="port=3322 sport=3323" add
```

Stopping an Oracle Internet Directory Server Instance by Using OIDCTL

If you have an Oracle Internet Directory server instance within a component that was created by using `oidctl`, and the instance has been started, you can stop it by typing:

```
oidctl connect=connect_string server=oidldapd inst=new_instance_number stop
```

For example:

```
oidctl connect=oiddb server=oidldapd inst=2 stop
```

Starting an Oracle Internet Directory Server Instance by Using OIDCTL

If you have an Oracle Internet Directory server instance within a component that was created by using `oidctl`, and the instance has been stopped, you can start it by typing:

```
oidctl connect=connect_string server=oidldapd inst=new_instance_number start
```

For example:

```
oidctl connect=oiddb server=oidldapd inst=2 start
```

The server is started with the port and sport flags that were specified when the instance was created.

Viewing Status Information by Using OIDCTL

You can use `oidctl` to view status. Type:

```
oidctl connect=connect_string status
```

The command `oidctl status` displays the status of all the Oracle Internet Directory instances that are running on the host, even though they might be on different Oracle instances.

Deleting an Oracle Internet Directory Server Instance by Using OIDCTL

To stop and permanently delete one Oracle Internet Directory server instance within a component, type

```
oidctl connect=connect_string server=oidldapd inst=new_instance_number \  
name=instanceName componentname=componentName delete
```

Only the `connect`, `server`, and `inst` arguments are required. `oidctl delete` deletes the configuration entry:

```
cn=componentName_new_instance_number,cn=oidldapd,cn=subconfigsubentry
```

Typically, the `inst` value of the original instance is 1, the second instance you create is 2, and so forth. For example:

```
oidctl connect=oiddb server=oidldapd inst=2 delete
```

Setting Up Oracle Database Advanced Replication-Based Replication

As of 11g Release 1 (11.1.1), LDAP-based replication can be used for multimaster replication as well as one-way and two-way replication. As a result, Oracle Database Advanced Replication-based replication is less important than it was in 10g (10.1.4.0.1). The only time you must use Advanced Replication in 11g Release 1 (11.1.1) is when you have Oracle Single Sign-On configured on the same machine and you want to replicate Oracle Single Sign-On data as well as Oracle Internet Directory data.

This appendix contains the following sections:

- [Introduction to Setting up Oracle Database Advanced Replication-Based Replication](#)
- [Setting Up Advanced Replication-Based Replication](#)

Note: All references to Oracle Single Sign-On and Oracle Delegated Administration Services in this appendix refer to Oracle Single Sign-On 10g (10.1.4.3.0) or later and Oracle Delegated Administration Services 10g (10.1.4.3.0) or later.

Introduction to Setting up Oracle Database Advanced Replication-Based Replication

In 11g Release 1 (11.1.1), you must use the command line to set up Advanced Replication. You can use the Replication Wizard in Oracle Enterprise Manager Fusion Middleware Control only for setting up LDAP-based replication.

Database Version Compatibility

If you are using Oracle Database Advanced Replication-based replication, all nodes in a directory replication group must be running the same version of Oracle Database.

Advanced Replication Filtering for Partial Replication

This section describes rules and best practices to follow when setting up Advanced Replication for partial replication. It contains the following topics:

See Also: ["Content to be Replicated: Full or Partial"](#) on page 6-2.

Excluded Naming Contexts

In Advanced Replication, you can only exclude naming contexts.

To exclude a naming context from replication in Oracle Database Advanced Replication-based replication, specify it using the `orcl_excluded_naming_context` attribute of the Oracle Database Advanced Replication-based replication agreement entry `orcl_agreement_id=000001`.

[Figure C-1](#) and the accompanying text further exemplify the use of the naming context container and its objects.

Figure C-1 Example of a Naming Context Container and Its Objects

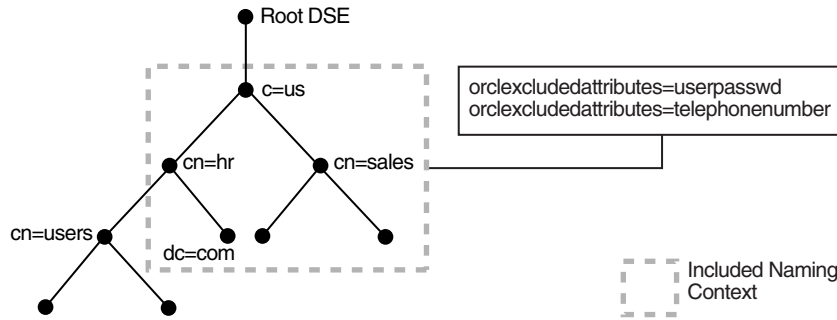

In [Figure C-1](#), the naming context included for replication is `c=us`. Within that naming context, one subtree, namely `cn=users`, `cn=hr`, `c=us` is excluded from replication. Moreover, two of the attributes of the `c=us` naming context are excluded from replication—namely, `userPassword` and `telephoneNumber`.

See Also: ["The Replication Naming Context Object Entry"](#) on page 40-6.

Rules for Advanced Replication Filtering.

This section describes the rules for Advanced Replication filtering.

The following naming contexts cannot be replicated:

- DSE root-specific entry
- `orcl_agreement_id=000001, cn=replication` configuration
- `cn=subconfigs` subentry
- `cn=Oracle Internet Directory`
- `cn=subregistrys` subentry

The following naming contexts cannot be excluded from replication:

- `cn=catalogs`
- `cn=subschemas` subentry
- `cn=oracleschema` version
- `cn=replication` configuration

Setting Up Advanced Replication-Based Replication

This section tells you how to configure multimaster replication groups, and how to resolve conflicts manually in them. It contains these topics:

- [Rules for Setting Up Advanced Replication](#)
- [Setting Up an Advanced Replication-Based Multimaster Replication Group](#)

- [Adding a Node for Advanced Replication-Based Multimaster Replication](#)
- [Deleting a Node from a Multimaster Replication Group](#)

See Also: The chapters on Multimaster Replication in *Oracle Fusion Middleware High Availability Guide*

Rules for Setting Up Advanced Replication

The following nine rules apply to replication based on Advanced Replication (sometimes referred to as ASR):

1. In this type of Directory Replication Group (DRG), there must be one node identified as the Master Definition Site (MDS): this is the group master. All other nodes taking part in the replication are replicas, which in database replication are termed "Remote Master Sites" (RMS).

Note: Even though it is not the central master, an Oracle Database Advanced Replication-based replica is sometimes called a remote master site (RMS), due to two facts. The first is that in Advanced Replication, when information is moved from one site to another, the recipient of the transferred information is called a "remote master site." The second fact is that independent changes made directly to an Oracle Database Advanced Replication-based replica are also replicated to all members of its group, making it a "master" during that interaction. Such a group, in which changes to any member are replicated to all other members, is called a multimaster replication group.

2. When you configure Multimaster replication, the master node for a Directory Replication Group (DRG) and each node that is to become an Oracle Database Advanced Replication-based replica must be initially empty, that is, a new Oracle Internet Directory installation.

Note: If the Master node is not a new installation, use the procedure described in "[Adding a Node for Advanced Replication-Based Multimaster Replication](#)" on page C-11 to add replicas. That procedure also initializes the replication group.

3. When you add an Oracle Database Advanced Replication-based replica, the new replica must be empty. That is, Oracle Internet Directory must be newly installed.
4. The sponsor node for each Oracle Database Advanced Replication-based replica can be any of the following:
 - A master node
 - An Oracle Database Advanced Replication-based replica of an existing multi-master DRG
 - A supplier of an LDAP replica that is not a consumer LDAP replica of any other LDAP replica
5. An Oracle Database Advanced Replication-based replica cannot be a consumer of an LDAP replica.

6. In Oracle Internet Directory 11g Release 1 (11.1.1), a node cannot be part of more than one multimaster replication group.
7. The data replicated between servers in a directory replication group does not include DSE root-specific data, server configuration data, and replication agreement data.

See Also: ["Advanced Replication Filtering for Partial Replication"](#) on page C-1

8. When an multimaster replication group is configured, the Oracle Single Sign-On database schema is automatically configured in replication.
9. When you add a node to a DRG, it must be running the same version of Oracle Internet Directory as the other nodes in the DRG. If you want to add a new 10g (10.1.4.0.1) node to a DRG containing nodes at an earlier release, first upgrade all existing nodes to 10g (10.1.4.0.1).

Setting Up an Advanced Replication-Based Multimaster Replication Group

This section discusses the general tasks you perform when installing and setting up a multimaster replication group. It contains these topics:

- [Task 1: Install Oracle Internet Directory on the Master Definition Site \(MDS\)](#)
- [Task 2: Install the Oracle Internet Directory on the Remote Master Sites \(RMS\)](#)
- [Task 3: Set Up Advanced Replication for a Directory Replication Group](#)
- [Task 4 \(Optional\): Load Data into the Directory](#)
- [Task 5: Ensure that Oracle Directory Server Instances are Started on All the Nodes](#)
- [Task 6: Start the Replication Servers on All Nodes in the DRG](#)
- [Task 7: Test Directory Replication](#)

Notes:

- The instructions in this section apply to setting up replication in a group of empty nodes. They assume that there is no pre-existing directory data on any of the nodes in the DRG. For instructions on adding a node to an existing DRG, see ["Adding a Node for Advanced Replication-Based Multimaster Replication"](#) on page C-11.
 - During entry replication, the directory replication server does not always preserve the spaces between RDN components in the DN. In some rare cases, it may not preserve the case of the letters in the DN.
-
-

Task 1: Install Oracle Internet Directory on the Master Definition Site (MDS)

Install Oracle Internet Directory on the master definition site, as described in *Oracle Fusion Middleware Installation Guide for Oracle Identity Management*.

You must be able to use Oracle Net Services to connect to the master definition site database and all other nodes in the DRG.

Note: During installation, make sure that each Oracle Internet Directory database instance name is unique on each machine.

Task 2: Install the Oracle Internet Directory on the Remote Master Sites (RMS)

Install Oracle Internet Directory on the remote master sites, as described in *Oracle Fusion Middleware Installation Guide for Oracle Identity Management*

If an Existing Master is Used as a Remote Master Site Although Oracle recommends starting with empty replicas, you *can* set up replication using machines initially configured as masters rather than replicas. To use a machine initially configured as a master as an RMS, you must first migrate its metadata to the MDS, as follows:

- Make sure the Oracle Internet Directory server is up and running on both the MDS and each such desired replica so that the process (`remtool -backupmetadata`) can succeed.
- From the newly created node, run the following command:

```
remtool -backupmetadata \
  -replica "new_node_host:new_node_port" \
  -master "master_host:master_port"
```

where `master_host:master_port` are the hostname and port number for the desired replica's supplier. you are prompted for the replication DN password.

Note: If Oracle Delegated Administration Services is not configured, you might see an error message similar to this when you run `remtool` with the `-backupmetadata` option:

```
Failed to add "orclApplicationCommonName=ias.example.com,
cn=IAS Instances, cn=IAS, cn=Products, cn=OracleContext"
as "uniquemember" to entry "cn=Associated Mid-tiers,
orclapplicationcommonname=DASApp, cn=DAS,cn=products,
cn=OracleContext at replica ldap://myhost:3060
```

Please ignore this error message.

- Apart from loading the metadata into master replica, this tool creates a file named `ocbkup.new_replica_id.TO.master_replicaid.timestamp.dat` containing the metadata as backup. This file is created under the `ORACLE_INSTANCE /diagnostics/logs/OID/tools` directory. This file contains the changes made to master replica in LDIF format, a copy of SSO container entry [`orclApplicationCommonName=ORASSO_SSOSEVER, cn=SSO, cn=Products, cn=OracleContext`] and DAS URL container entry [`cn=OperationURLs, cn=DAS, cn=Products, cn=OracleContext`].

- If the metadata backup succeeds, it displays a message in the terminal:

```
Backup of metadata will be stored in
ORACLE_INSTANCE/diagnostics/logs/OID/tools/ocbkup.replicaid_
pilot.TO.replicaid_master.timestamp.ldif.
```

```
Metadata copied successfully.
```

The message contains the actual path of `ORACLE_INSTANCE` and the filename.

- If an error occurs during this operation, `remtool` reports the error in the terminal from which it was invoked. The error messages are also logged in `ORACLE_INSTANCE/diagnostics/logs/OID/tools/remtool.log` file.

After successfully migrating the master's metadata to the MDS, you can now safely continue with "[Task 3: Set Up Advanced Replication for a Directory Replication Group](#)" on page C-6.

Task 3: Set Up Advanced Replication for a Directory Replication Group

The following sections lead you through installing and setting up Advanced Replication by using the Replication Management Tool.

See Also: *Oracle Database Advanced Replication* in the Oracle Database Documentation Library, and the online Help for the Replication Management Tool, for information on setting up Oracle Database Advanced Replication-based replication.

To establish a directory replication group (DRG), you must configure the Advanced Replication environment by performing the tasks discussed in these topics:

- [On All Nodes, Prepare the Oracle Net Services Environment for Replication](#)
- [From the MDS, Configure Advanced Replication For Directory Replication](#)

On All Nodes, Prepare the Oracle Net Services Environment for Replication For *each node* in the directory replication group, perform the steps listed here. (Each step is described more fully in the subsections that directly follow this list.)

1. [Configure `sqlnet.ora`.](#)
2. [Configure `tnsnames.ora` in each Oracle Internet Directory `ORACLE_INSTANCE` and Oracle Database `ORACLE_INSTANCE`.](#)
3. [Stop and restart the listener, both in the Oracle Internet Directory `ORACLE_HOME` and in the Oracle Database `ORACLE_HOME`.](#)
4. [Test Oracle Net connections to all nodes from each node in the DRG.](#)

To prepare the Oracle Net Services environment for replication:

1. Configure `sqlnet.ora`.

The `sqlnet.ora` file should contain the following parameters at minimum:

```
names.directory_path = (TNSNAMES)
names.default_domain = global_database_domain
```

On UNIX, the `sqlnet.ora` file is in `ORACLE_INSTANCE/network/admin`.

On Microsoft Windows, the `sqlnet.ora` file is in `%ORACLE_HOME%\network\admin`.

2. Configure `tnsnames.ora` in each Oracle Internet Directory `ORACLE_INSTANCE` and Oracle Database `ORACLE_INSTANCE`.

On each node in the DRG, define all Oracle Internet Directory database instances in the DRG. Each `tnsnames.ora` file, in the Oracle Internet Directory `ORACLE_INSTANCE` and in the Oracle Database `ORACLE_HOME`, must contain connect descriptor information in the following format for each Oracle Internet Directory database:

```
net_service_name =
(DESCRIPTION =
```

```
(ADDRESS =
(PROTOCOL = TCP)
(HOST = HOST_NAME_OR_IP_ADDRESS)
(PORT = port_no_of_listener))
(CONNECT_DATA =
(service_name = service_name_of_database)))
```

where `net_service_name` is the global name of the database. For example, if the database global name is `mds.sales.com`, then your `net_service_name` must be `mds.sales.com`. Ensure that your database global name and your `net_service_name` are domain-qualified. In this example, the global name and `net_service_name` are domain-qualified with `sales.com`.

Notes:

- The database global name is composed of the `DB_NAME` and `DB_DOMAIN` initialization parameters of your database. For example, if your database's `DB_NAME` is `mds` and `DB_DOMAIN` is `sales.com`, your database global name is `mds.sales.com`. The global name is not domain qualified if the `DB_DOMAIN` initialization parameter is not defined.
 - The value of the `NAMES.DEFAULT_DOMAIN` parameter in the `sqlnet.ora` file must match the value of the `DB_DOMAIN` initialization parameter of the database.
 - You must domain-qualify the net service name (for example, `sales.com`), but be sure that the domain component matches the one specified in the `NAMES.DEFAULT_DOMAIN` parameter in the `sqlnet.ora` file.
-
-

See Also: *Oracle Database Net Services Reference* for more information on `tnsnames.ora` syntax.

On UNIX, the `tnsnames.ora` file is in `ORACLE_INSTANCE/config`.

On Microsoft Windows, the `tnsnames.ora` file is in `%ORACLE_INSTANCE%\config`.

3. Stop and restart the listener, both in the Oracle Internet Directory `ORACLE_HOME` and in the Oracle Database `ORACLE_HOME`.

To stop the listener for the Oracle Internet Directory database, use the listener control utility, `$ORACLE_HOME/bin/lsnrctl` in the Oracle Database Oracle home. Type the following command at the `lsnrctl` command prompt:

```
SET PASSWORD
STOP [listener_name]
```

`SET PASSWORD` is required only if the password is set in the `listener.ora` file. you are prompted for the password to set. The default listener name is `LISTENER`.

To restart the listener for the Oracle Internet Directory database, type the following command at the `lsnrctl` command prompt:

```
START [listener_name]
```

```
quit
```

4. Test Oracle Net connections to all nodes from each node in the DRG.

IMPORTANT: Try to connect using both of these commands:

```
sqlplus ods@net_service_name_without_domain_name
sqlplus ods@net_service_name_with_domain_name
```

you are prompted for the `ods_password`. If you cannot connect, then replication will not work.

From the MDS, Configure Advanced Replication For Directory Replication To do this:

1. From the MDS console, connect as the system user on all nodes, including the MDS. Ensure the following on all nodes:
 - The Oracle Internet Directory database is running
 - The Oracle Internet Directory listener is running
 - The connect string is correct
 - The system password is correct
2. Ensure the following wallets exist on the remote sites:
 - A wallet for storing the password to the database designated for Oracle Internet Directory. This wallet is named `oidpwdlldap1` and is located in the directory `ORACLE_INSTANCE/OID/admin`.
 - A wallet for storing the password of the replication administrator. This wallet is named `oidpwwroracle_sid`, and is located in the directory `ORACLE_INSTANCE/OID/admin`. (The `oracle_sid` is obtained from the connected database.)

If the wallets do not exist on a specific site, create them by typing the following command on the remote node:

```
oidpasswd connect=connect_string create_wallet=true
```

3. Check the prerequisites in the attached Note. Then, at a command prompt in the MDS, use `remtool` (the Replication Environment Management Tool) to configure Advanced Replication by running the following command:

```
$(ORACLE_HOME)/ldap/bin/remtool -asrsetup
```

See Also:

- The `remtool` command-line tool reference in *Oracle Fusion Middleware Reference for Oracle Identity Management* for information about using the `-asrsetup` option of the Replication Environment Management Tool (`remtool`).
- *Oracle Database Administrator's Guide* in the Oracle Database Documentation Library for instructions on ensuring that the database and listener are running
- *Oracle Database Net Services Administrator's Guide* in the Oracle Database Documentation Library for instructions on ensuring that the connect string is correct

Notes:

- If you encounter errors, then clean up the environment by using the `-asrcleanup` option of the Replication Environment Management Tool. Then repeat Step 3.
 - As part of "Task 3: Set Up Advanced Replication for a Directory Replication Group", the Replication Environment Management Tool (`remtool`) sets default values for the replication configuration parameters, which enables you to simply start the replication servers. If you want to change the replication configuration parameters, see [Chapter 41, "Managing and Monitoring Replication."](#)
-
-

Task 4 (Optional): Load Data into the Directory

You can choose either of two ways to load data into the directory:

- To add just a small number of entries to the DRG, you can wait until you have completely configured the DRG. Then use `ldapadd` to load the data to one of the nodes. The entries are then be replicated to the other nodes at the specified time.
- To add a large amount of data to load into the DRG, use the bulkload utility:
 - a. Stop the LDAP server at all nodes of the DRG by typing:

```
opmnctl stopproc process-type=OID
```

- b. On the node that is part of the DRG and where you have the `ldif` file to be loaded onto the directories, ensure that `ORACLE_INSTANCE` is set, then enter:

```
bulkload connect="connect_string" check="TRUE" \
generate="TRUE" file="file_with_absolute_path_name"
```

Note: If data is extracted from Oracle Internet Directory using `ldifwrite`, then, in addition to other options, use the `restore="TRUE"` option to restore the operational attributes.

- c. On the same node, ensure `ORACLE_INSTANCE` is set, then enter:

```
bulkload connect="connect_string_1" load="TRUE"
```

Repeat step c on the same node, each time replacing `connect_string_1` with the connect string of another node in the DRG, until you have loaded the data onto all the nodes in the DRG. For example, enter:

```
bulkload connect="connect_string_2" load="TRUE"
```

then enter

```
bulkload connect="connect_string_3" load="TRUE"
```

and so on, until you loaded the data onto all the nodes in the DRG.

Notes:

- `connect_string` is the connect string of the local Oracle Internet Directory database.
 - For successful replication, an entry must have the same `orclguid` (global identifier) at all replicated nodes. This is accomplished by performing Step b once and repeating Step c for all nodes in the DRG.
-

See Also: The `bulkload` command-line tool reference in *Oracle Fusion Middleware Reference for Oracle Identity Management* for syntax and usage notes

Task 5: Ensure that Oracle Directory Server Instances are Started on All the Nodes

The out-of-box configuration has Oracle Internet Directory LDAP Server instance #1 configured with change logging set to TRUE. This default instance of Oracle Internet Directory LDAP Server can be started as follows:

```
opmnctl startproc process-type=OID
```

Task 6: Start the Replication Servers on All Nodes in the DRG

To start replication servers on all nodes, type the following command on each node:

```
oidctl connect=connStr server=oidrepld instance=1 componentname=oidComponentName \
flags="-h LdapHost -p LdapPort" start
```

Note that the instance number need not be unique across the entire DRG.

Note: If you are deploying a single master with read-only replica consumers, you can reduce performance overhead by turning off conflict resolution. To do so, change the value of `orclconflresolution` to 0 by using the following ldif file with `ldapmodify`:

```
dn: cn=configset0,cn=osdrepld,cn=subconfigsubentry
changetype: modify
replace: orclconflresolution
orclconflresolution: 0
```

See Also:

[Chapter 4, "Understanding Process Control of Oracle Internet Directory Components"](#) for information on Oracle Internet Directory process control.

Task 7: Test Directory Replication

Test replication as described in

Note: If you want to configure replication for Oracle Single Sign-On, then follow the postinstallation steps specific to Oracle Single Sign-On. These are found in the replication installation section of the *Oracle Application Server Single Sign-On Administrator's Guide*, in the 10g (10.1.4.0.1) library.

Adding a Node for Advanced Replication-Based Multimaster Replication

Note: A new node that you add to an existing multimaster replication group must have Oracle Internet Directory installed on it. For more information, see "[Task 2: Install the Oracle Internet Directory on the Remote Master Sites \(RMS\)](#)" on page C-5.

You can add a node to a master node, or to an LDAP-based supplier replica that is not a consumer of any other LDAP based replicas, to form a multimaster DRG. When you do so, the steps in this section automatically perform an initial install and configuration of Advanced Replication.

To add a new replication node to a live, functioning replication group or to a master node of any significant size, perform the following steps:

- [Prepare the Oracle Net Services Environment](#)
- [Task 1: Stop the Directory Replication Server on All Nodes](#)
- [Task 2: Identify a Sponsor Node and Install Oracle Internet Directory](#)
- [Task 3: Switch the Sponsor Node to Read-Only Mode](#)
- [Task 4: Back up the Sponsor Node by Using Idifwrite](#)
- [Task 5: Perform Advanced Replication Add Node Setup](#)
- [Task 6: Switch the Sponsor Node to Updatable Mode](#)
- [Task 7: Start the Directory Replication Server on All Nodes Except the New Node](#)
- [Task 8: Load Data into the New Node by Using bulkload](#)
- [Task 9: Start the Directory Server on the New Node](#)
- [Task 10: Start the Directory Replication Server on the New Node](#)

Note: Commands shown in the following tasks require the following types of items to be stored as follows:

- Binaries: \$ORACLE_HOME/bin
- SQL scripts: \$ORACLE_HOME/ldap/admin
- UNIX scripts: \$ORACLE_HOME/ldap/bin

Before beginning "[Task 2: Identify a Sponsor Node and Install Oracle Internet Directory](#)", be sure that all three of these types of items are in the path.

Prepare the Oracle Net Services Environment

"[On All Nodes, Prepare the Oracle Net Services Environment for Replication](#)" on page C-6 describes the process that prepares this environment.

Task 1: Stop the Directory Replication Server on All Nodes

To stop the directory replication server, run the following command on each node in the LDAP replication group:

```
oidctl connect=connStr server=oidrepld instance=1 componentname=oidComponentName\  
flags="-h LdapHost -p LdapPort" stop
```

Task 2: Identify a Sponsor Node and Install Oracle Internet Directory

You must identify a sponsor node for this Task. It is the node that supplies the data to the new node.

For the RMS, Oracle recommends that you install the new instance of Oracle Internet Directory as an Advanced Replication replica. (You could use an existing master node as the RMS, but extra manual steps are required.)

Install a new Oracle Internet Directory on the remote site.

If an existing master is used as RMS, you must follow the instructions in ["If an Existing Master is Used as a Remote Master Site"](#) on page C-5 to migrate the master's metadata to the sponsor node. After successfully migrating the master's metadata to the MDS, you can now safely continue with ["Task 3: Switch the Sponsor Node to Read-Only Mode"](#).

Task 3: Switch the Sponsor Node to Read-Only Mode

A sponsor node is the node that supplies the data to the new node. To switch the sponsor node from read/write to read-only mode, use one of the procedures in ["Changing Server Mode"](#) on page 15-2

Note: While the sponsor node is in read-only mode, you may not make any updates to it. You may, however, update any of the other nodes, but those updates are not replicated immediately.

Also, the sponsor node and the MDS may be the same node.

Task 4: Back up the Sponsor Node by Using Idifwrite

Because this may take a long time, you may start ["Task 5: Perform Advanced Replication Add Node Setup"](#) while backup is in process.

On the sponsor node, verify that `ORACLE_INSTANCE` is set, then enter the following command:

```
ldifwrite connect="connect_string" \  
baseDN="orclAgreementID=000001,cn=replication configuration" \  
file="output_ldif_file"
```

This backs up the directory of the sponsor node.

Task 5: Perform Advanced Replication Add Node Setup

Note: Oracle Net Service must be configured properly on all nodes for replication. See: ["On All Nodes, Prepare the Oracle Net Services Environment for Replication"](#) on page C-6.

You can perform the Advanced Replication add node setup at the same time that you perform ["Task 4: Back up the Sponsor Node by Using Idifwrite"](#) on page C-12.

On the sponsor node, enter this command:

```
remtool -addnode
```

The Replication Environment Management Tool adds the node to the DRG.

Note:

When you run `remtool -addnode` to add the first Advanced Replication replica of a replication group, the tool does the initial replication setup for you, as if you had used `remtool -asrsetup`. You must specify the sponsor node's connect identifier when you use `remtool -addnode`.

When you use `remtool -addnode`, the operation might take a long time to complete, depending on the number of rows available in replicated tables and the network latency between the nodes. Use the `-v` option to view the progress of this operation.

If you encounter errors, then use the `-asrverify` option first. If it reports errors, then rectify them by using the `-asrrectify` option. Both `-asrverify` and `-asrrectify` list all nodes in the DRG. If the new node is in the list, remove the new node by running the Replication Environment Management tool with `-delnode` option. Then add the new node again using the `-addnode` option.

See Also: The `remtool` command-line reference in *Oracle Fusion Middleware Reference for Oracle Identity Management* for instructions on using the `-addnode` option of the Replication Environment Management Tool

Task 6: Switch the Sponsor Node to Updatable Mode

To switch the sponsor node to updatable mode, use one of the procedures in ["Changing Server Mode"](#) on page 15-2.

Note: Task 6 is very similar to Task 3. The only difference is that the `orclservermode` parameter is being set back to Read/Write in this step.

Task 7: Start the Directory Replication Server on All Nodes Except the New Node

To start the directory replication server, type the following command on all nodes except the new node:

```
oidctl connect=connStr server=oidrepld instance=1 componentname=oidComponentName \
  flags="-h LdapHost -p LdapPort" start
```

To ensure that no directory or replication processes are running on the new node, type:

```
opmnctl stopproc process-type=OID
```

Task 8: Load Data into the New Node by Using bulkload

To load data, ensure that `ORACLE_INSTANCE` is set, then type the following command on the new node:

```
bulkload connect="db_connect_string_of_new_node" check="TRUE" generate="TRUE" \  
load="TRUE" restore="TRUE" \  
file="absolute_path_to_the_ldif_file_generated_by_ldifwrite"
```

Note: If you load data from an earlier version of Oracle Internet Directory, such as 10g Release 2 (10.1.2.0.2) onto a node running 10g (10.1.4.0.1), you must update the password policy entries as described in "[Password Policy and Fan-out Replication](#)" on page 38-28.

Task 9: Start the Directory Server on the New Node

To start the directory server, type the following command on the new node:

```
opmnctl startproc process-type=OID
```

Task 10: Start the Directory Replication Server on the New Node

Note: If you must change configuration or agreement parameters, see [Chapter 41, "Managing and Monitoring Replication"](#).

To start the directory replication server, type the following command on the new node:

```
oidctl connect=connStr server=oidrepld instance=1 componentname=oidComponentName \  
flags="-h LdapHost -p LdapPort" start
```

Notes:

- If a directory server instance is participating in a replication agreement, do not use the `bulkload` tool to add data into the node. Instead, use `ldapadd`.
 - If Oracle Single Sign-On is desired in replication, then follow the postinstallation steps in the replication installation section of the *Oracle Application Server Single Sign-On Administrator's Guide* in the 10g (10.1.4.0.1) library.
-
-

Deleting a Node from a Multimaster Replication Group

At times, you may want to delete a node from a DRG (for example, if the addition of a new node did not fully succeed as a result of system errors).

To delete a replication node, perform the tasks described in these topics:

- [Task 1: Stop the Directory Replication Server on All Nodes](#)
- [Task 2: Stop All Oracle Internet Directory Processes in the Node to be Deleted](#)
- [Task 3: Delete the Node from the Master Definition Site](#)
- [Task 4: Start the Directory Replication Server on All Nodes](#)

Task 1: Stop the Directory Replication Server on All Nodes

To stop the directory replication server, run the following command on each node in the DRG:

```
oidctl connect=connStr server=oidrepld instance=1 componentname=oidComponentName \
  flags="-h LdapHost -p LdapPort" stop
```

Task 2: Stop All Oracle Internet Directory Processes in the Node to be Deleted

On the node to be deleted, shut down Oracle Internet Directory.

```
opmnctl stopproc process-type=OID
```

See Also: The `opmn` command-line tool reference in *Oracle Fusion Middleware Reference for Oracle Identity Management* for more information about shutting down Oracle Internet Directory.

Task 3: Delete the Node from the Master Definition Site

From the MDS, run the following script:

```
remtool -delnode
```

The Replication Environment Management Tool deletes the node from the replication group.

See Also: The `remtool` command-line tool reference in *Oracle Fusion Middleware Reference for Oracle Identity Management* for instructions on using the `-delnode` option of the Replication Environment Management Tool

This process can take a long time, depending on your system resources and the size of your DRG. If you use the `-v` option, the tool keeps you informed of its progress.

Note: If you encounter errors, then use the `-asrverify` option first. If it reports errors, then rectify them by using the `-asrrectify` option. Both `-asrverify` and `-asrrectify` list all nodes in the DRG. If the node to be deleted is in the list, then delete it by running the Replication Environment Management tool again, using the `-delnode` option.

Task 4: Start the Directory Replication Server on All Nodes

To start the directory replication server, type the following command on each of the remaining nodes of the DRG:

```
oidctl connect=connStr server=oidrepld instance=1 componentname=oidComponentName \
  flags="-h LdapHost -p LdapPort" start
```

See Also: The `opmn` command-line tool reference in *Oracle Fusion Middleware Reference for Oracle Identity Management*

How Replication Works

This appendix contains advanced information about replication. It contains the following topics:

- [Features of Oracle Database Advanced Replication-Based Replication](#)
- [Architecture for Oracle Database Advanced Replication-Based Replication](#)
- [Architecture of LDAP-Based Replication](#)
- [LDAP Replica States](#)
- [The Replication Process](#)

Note: All references to Oracle Single Sign-On in this appendix refer to Oracle Single Sign-On 10g (10.1.4.3.0) or later.

Features of Oracle Database Advanced Replication-Based Replication

In Oracle Database Advanced Replication-based replication, the transport of update information between Oracle Internet Directory nodes in a replication agreement is managed by Oracle Database Advanced Replication, a store-and-forward transport feature. Advanced Replication enables you to synchronize database tables across two Oracle databases.

Oracle Database Advanced Replication:

- Stores local changes and periodically propagates them in batches to consumers. The consumer replication servers apply the remote changes to their own local directory servers, and then purge the applied remote changes from their local stores.
- Enables read and update access to directory tables anywhere in the Oracle replication group. Typical Advanced Replication configurations use row-level replication.
- Provides proven network tolerance. Data transfer can be controlled and monitored by. Such manageability allows a high degree of flexibility in how the data transfer is scheduled.

Note: The Oracle Single Sign-On database schema that resides in the same database as Oracle Internet Directory is also replicated by Advanced Replication.

See Also:

- The section "Configuring Oracle Single Sign-On for Replication" in the chapter on high availability in the *Oracle Application Server Single Sign-On Administrator's Guide* in the 10g (10.1.4.0.1) library.
- *Oracle Database Advanced Replication* in the Oracle Database Documentation Library for information about Advanced Replication

Architecture for Oracle Database Advanced Replication-Based Replication

Typical Oracle Database Advanced Replication configurations use asynchronous data propagation—that is, suppliers write their changes to change logs, and then regularly send batched changes to other consumers. Consumers receive the change log data, then reproduce the changes locally.

When you configure replication, you specify which nodes in a replication group share changes. Regardless of the number of nodes you introduce into the replication environment, the basic architecture for replication remains the same. Local changes are distributed to a remote master site where the replication server, acting as a client, sends commands to the Oracle Internet Directory server that implements them.

Figure D–1 and its accompanying text provides an overview of the Oracle Database Advanced Replication process.

Figure D–1 Advanced Replication Process

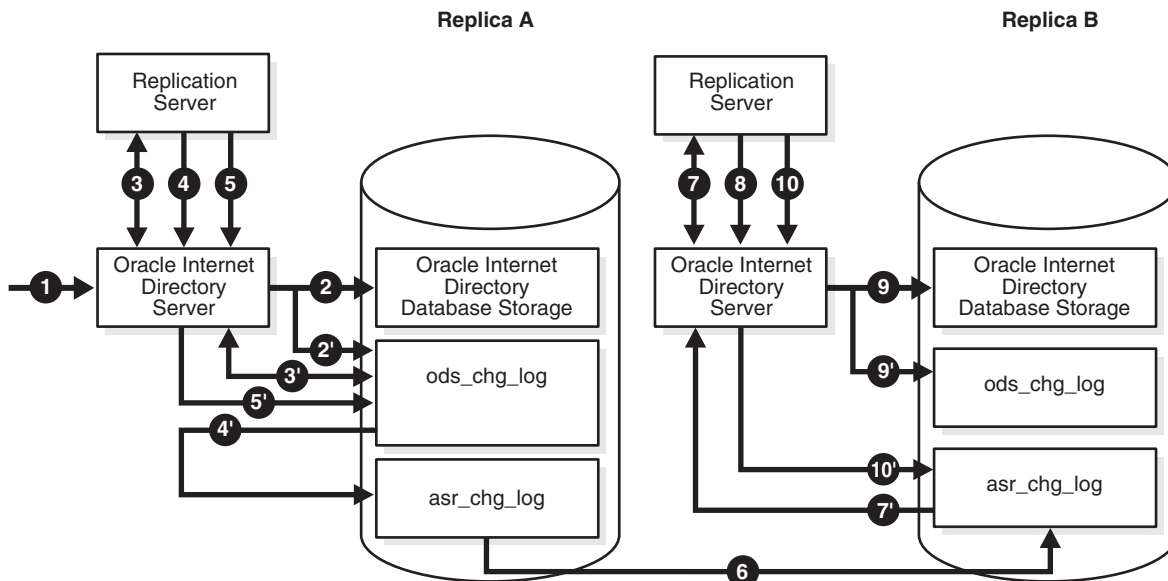

The events are as follows:

1. A change request is made on the Oracle Internet Directory server of Replica A.
2. The change is accepted and committed to storage in the Oracle Internet Directory Database.
- 2' A new change log is generated for the operation, and stored in the ods_chg_log table, where server = Replica A.

3. The replication server on Replica A queries for new outbound change logs from the local `ods_chg_log` table. The filter used for the query is:

```
( & (objectclass=changeLogEntry) (servername=ReplicaID_of_A)
  (changeNumber>= Last_Applied_ChgNum_From_A_TO_A) )
```

A control is also passed along with this search operation with the value of `orclreplicationid` specified in the processing agreement. The value 1 is reserved for Advanced Replication agreements.

`Last_Applied_ChgNum_From_A_TO_A` is the outbound change log processing status.

- 3' The directory server internally queries `ods_chg_log` for new change logs and returns fetched change logs.
4. The new change log retrieved from `ods_chg_log` is copied to local `asr_chg_log`.
- 4' The replication server copies retrieved change logs to the local `asr_chg_log`.
5. The replication server requests Oracle Internet Directory server to update the Change log `retry_cnt` status properly.
- 5' Oracle Internet Directory server updates the `retry_cnt` of the change log in the `ods_chg_log` table.
6. The new change log is pushed From Replica A to Replica B through Oracle Database Advanced Replication.
7. If the last transported number is greater than last applied change number on Replica B, it indicates that there are new changes in local change log store `asr_chg_log`. In that case, the replication server on Replica B queries for new inbound change logs from its local `asr_chg_log` table. The filter used is:

```
( & (objectclass=changeLogEntry) (servername=ReplicaID_of_A)
      (changeNumber>= Last_Applied_ChgNum_From_A_TO_B) )
```
- 7' The directory server queries `asr_chg_log` for new change logs.
8. The replication server applies the new change at Replica B.
9. Oracle Internet Directory server at Replica B accepts and commits the change to storage in the Oracle Database.
 - 9' If the local replica has any LDAP-based consumer replicas, a change log is regenerated in the `ods_chg_log` table at Replica B, with the following regenerating rules:

```
server = server of local replica,
ReplicaB orclreplicationid/chg_rid = 1
Modifiersname = Replbind_DN_of_A
orclreplicatid/chg_rid is set to the value of orclreplicationid of the
processing agreement. In this case, because the change is replicated and processed
through Advanced Replication, it is set to 1 because 1 is reserved for Advanced
Replication.
```
10. The replication server request Oracle Internet Directory server to update the shadow change log `retry_cnt` status properly.
 - 10' Oracle Internet Directory server updates the `retry_cnt` of the shadow change log in the database.

Purging occurs regularly, removing entries that are already applied and those that are dropped as candidate changes. Remote change records in the local change log table are purged by the garbage collection thread if they have been applied locally. Local change records in the local change log table are purged by the garbage collection thread if they have been distributed to all the consumers.

See Also: Chapter 41, "Managing and Monitoring Replication" for information on configuring replication

Architecture of LDAP-Based Replication

This section gives a more detailed look at LDAP replication. Data flow in LDAP replication consists of two phases, transport and apply.

Figure D-2 and its accompanying text explain the fan-out replication process.

Figure D-2 LDAP Replication Process

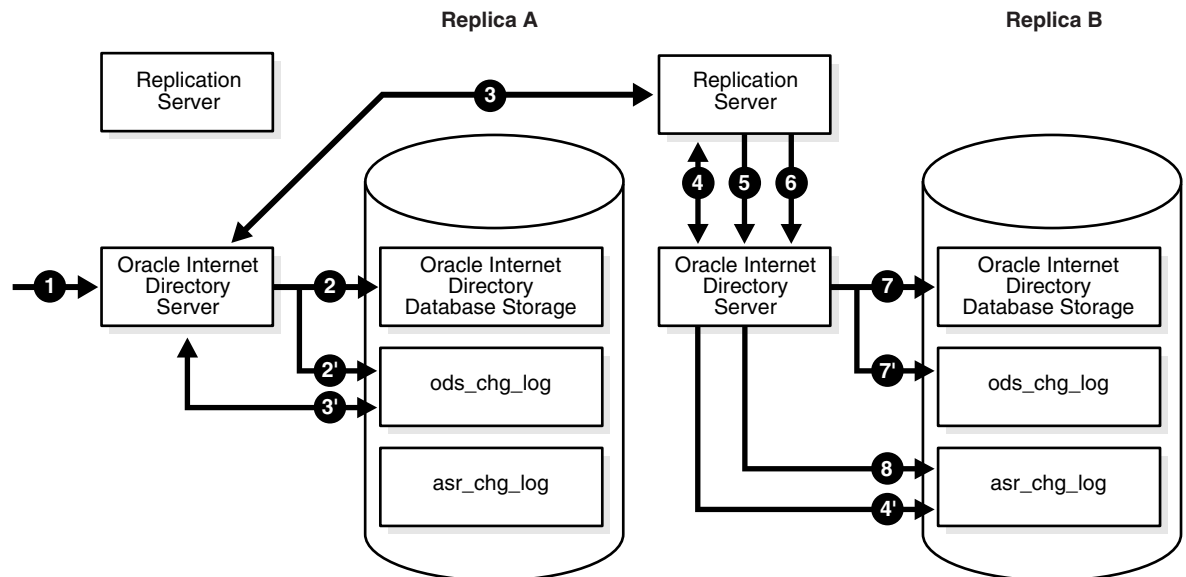

1. An LDAP change request is made on the Oracle Internet Directory server of Replica A.
2. The change is accepted and committed to Oracle Internet Directory database storage.
- 2'. A new change log is generated for the operation and stored in the ods_chg_log table, where:

server = Replica A

orclreplicationid/chg_rid = 0 (The value 0 is for user operations)

Modifiersname = user DN of the Modifier (by default)

3. The replication server on Replica B queries for new inbound change logs from the supplier replica, Replica A's ods_chg_log table]. The filter used for the query is:

```
(& (objectclass=changelogentry)
(changeNumber>=Last_Transported_ChgNum_From_A_TO_B)
(! (modifiersname=ReplicaID_of_B))
(! (orclreplicatonid =
Orclreplicationid_Attribute_Value_of_Processing_Agreement))
```



```
(!(targetdn=*,excluded_naming_ctx_dn ) (...) (...) ...)
(targetdn=cn=catalogs) (targetdn=cn=subschemasubentry)
(targetdn=cn=oracleschemaversion) (targetdn=*,included_naming_ctx_dn)
(targetdn=...)
...)
```

A control is also passed along with this search operation with the value of `orclreplicationid` specified in the processing agreement.

4. The replication Server at B requests that the Oracle Internet Directory at Replica B store the new change log as a shadow change log.

4'. The Oracle Internet Directory server at Replica B stores the shadow change log in the `asr_chg_log` table at Replica B.

Steps 3, 3', and 4 correspond with the transport part of LDAP-based change log processing

5. The replication server at Replica B checks whether the last transported number is greater than the last applied change number on Replica B. If so, it indicates that there are new changes in the local change log store `asr_chg_log`. In that case, the replication server at Replica B queries the local store `asr_chg_log` for new change logs from A. The filter for the query is:

```
(& (objectclass=changeLogEntry) (servername=ReplicaID_of_A)
(changeNumber>= Last_Applied_ChgNum_From_A_TO_B))
```

6. The replication server at Replica B request that the Oracle Internet Directory server at Replica B apply the retrieved change to storage.
7. Oracle Internet Directory server at Replica B accepts and commits the change to Oracle Internet Directory database storage.

7' If the local replica is the source of any other replicas, a change log is regenerated in `ods_chg_log` table at Replica B, which follows the following changelog regeneration rules:

```
server = server of local replica, ReplicaB
orclreplicationid/chg_rid = N
Modifiersname = Replbind_DN_of_A
```

`orclreplicatid/chg_rid` is set to the `orclreplicationid` value of the processing agreement.

8. The replication server requests that the server update the shadow change log `retry_cnt` status properly.

LDAP Replica States

This section describes the replica states for LDAP-based replication. LDAP replica states have no effect upon Advanced Replication.

When LDAP based replication is configured, and the replication server is started, the server reads the replica state `orclreplicastate` from the local replica, "`orclreplicaid=local_Replica_ID, cn=replication configuration`". The replication server behaves differently, based upon the local replica state, as shown in [Table D-1](#). The replication server reads the local replica state from the local (consumer) node.

Note: On Windows systems, ensure that the replication server is not running before you enable bootstrapping by changing the value of `orclReplicaState` to 0.

Table D-1 LDAP Replica States

Value	Meaning	Server Behavior
0	Bootstrap	<p>Starts replication bootstrap processing to synchronize the consumer directory from the supplier, based on the replication naming context configuration. Updates the replica state to correspond with bootstrap progress.</p> <ul style="list-style-type: none"> ■ Sets the replica state to 3 (Bootstrap in progress) immediately when it starts to bootstrap. ■ Sets the replica state to 4 (Bootstrap in progress, <code>cn=oraclecontext</code> bootstrap has completed) after it completes bootstrapping of "<code>cn=oraclecontext</code>" successfully ■ Sets the replica state to 5 (Bootstrap Error occurred) after bootstrap is completed but failure(s) detected during the bootstrap. Then it waits until the replica state is re-set. <p>Note: Human intervention is required; See "Troubleshooting Oracle Internet Directory Replication" on page R-18 for details.</p> <ul style="list-style-type: none"> ■ Sets the replica state to 1 (On-line) after bootstrap has completed successfully. Then replication automatically starts to perform normal replication processing.
1	On line	Starts normal replication processing to replicate changes from the supplier to the consumer.
2	Off line	<p>Logs an error message in <code>oidrepld.log</code> similar to this:</p> <pre>2004/09/24:17:41:44 * Replica(dlsun1418_replica2) is in OFFLINE mode, Please update the replica state and restart OIDREPLD...</pre> <p>The administrator must set the replica state properly and restart the replication server.</p>
3	Bootstrap in progress	Sets the replica state back to 0 (Bootstrap), then starts to bootstrap again as if the replica state were 0.
4	Bootstrap in progress, <code>cn=oraclecontext</code> bootstrap has completed.	Sets the replica state back to 0 (Bootstrap), then starts to bootstrap again as if the replica state were 0.
5	Bootstrap completed; failure detected for one or more naming contexts.	<p>Logs an error message in <code>oidrepld.log</code> similar to this:</p> <pre>2004/09/24:17:13:30 * Replication BOOTSTRAP_ERROR mode detected for replica(dlsun1418_replica2)</pre> <p>Then it waits until the replica state is reset properly.</p>
6	Database copy-Based addnode;	This mode indicates that the replica is a database copy-based addnode.
7	Sync schema	Sync schema, but not data, from supplier to consumer.

Table D-1 (Cont.) LDAP Replica States

Value	Meaning	Server Behavior
8	Boot strap without schema sync	If schema sync was previously performed, but bootstrapping failed at a subsequent step, bootstrapping is started again without performing another schema sync.

Oracle Internet Directory replication server logs the bootstrapping process in the Oracle Internet Directory replication server log, `$ORACLE_INSTANCE/diagnostics/logs/OID/componentName/oidrepld00.log`.

If bootstrap completes successfully, the log looks similar to the following example, and the replication server automatically starts to perform normal replication processing.

```
2004/10/06:17:13:25 * Starting OIDREPLD against isunnad03:5555...
2004/10/06:17:13:26 * Starting scheduler...
2004/10/06:17:13:27 * Start to BootStrap from supplier=isunnad03_purify to
consumer=isunnad03_purify3
2004/10/06:17:13:28 * gslrbssSyncDIT:Replicating namingcontext=cn=oraclecontext
.....
2004/10/06:17:14:21 * gslrbssSyncDIT:Sync done successfully for namingctx:
cn=oraclecontext, 222 entries matched
2004/10/06:17:14:21 * gslrbssSyncDIT:Replicating namingcontext=c=india .....
2004/10/06:17:14:21 * gslrbssSyncDIT:Sync done successfully for namingctx:
c=india, 0 entries matched
2004/10/06:17:14:21 * gslrbssSyncDIT:Replicating namingcontext=c=uk .....
2004/10/06:17:19:57 * gslrbssSyncDIT:Sync done successfully for namingctx: c=uk,
1087 entries matched
2004/10/06:17:19:57 * gslrbssSyncDIT:Replicating
namingcontext=cn=oracleschemaversion .....
2004/10/06:17:19:59 * gslrbssSyncDIT:Sync done successfully for namingctx:
cn=oracleschemaversion, 10 entries matched
2004/10/06:17:20:01 * gslrbsbBootStrap: BOOTSTRAP DONE SUCCESSFULL
```

If failures are detected, the log looks similar to the following example:

```
2004/09/14:12:57:23 * Starting OIDREPLD against dlsun1418:4444...
2004/09/14:12:57:25 * Starting scheduler...
2004/09/14:12:57:26 * Start to BootStrap from supplier=dlsun1418_replica to
consumer=dlsun1418_replica2
2004/09/14:12:57:27 * gslrbssSyncDIT:Replicating namingcontext=cn=oraclecontext
.....
2004/09/14:12:58:21 * gslrbssSyncDIT:Sync done successfully for namingctx:
cn=oraclecontext, 222 entries matched
2004/09/14:12:58:21 * gslrbssSyncDIT:Replicating namingcontext=cn=quan zhou .....
2004/09/14:12:58:23 * BootStrap failure when adding DN=cn=Quan
Zhou,server=dlsun1418_replica2,err=Constraint violation.
2004/09/14:12:58:23 * gslrbssSyncDIT:Sync failed for namingctx: cn=quan zhou, only
1 entries retrieved
2004/09/14:12:58:23 * gslrbssSyncDIT:Replicating
namingcontext=cn=oracleschemaversion .....
2004/09/14:12:58:25 * gslrbssSyncDIT:Sync done successfully for namingctx:
cn=oracleschemaversion, 10 entries matched
2004/09/14:12:58:51 * gslrbsbBootStrap: Failure occurred when bootstrapping 1 out
of 3 namingcontext(s) from the supplier
```

Tip: You have two options for troubleshooting bootstrap failure.

- Option 1: Identify the cause of the bootstrap failure and fix the cause, then restart bootstrapping by setting the consumer replica's `orclreplicastate` to Bootstrap mode.
- Option 2: Identify the naming contexts that failed to be bootstrapped and use `oidcmprec` to reconcile them. Then resume replication by setting the consumer replica's `orclreplicastate` to Online mode.

Note: `oidrepld` is now in `Bootstrap_error` mode, so you do need to reset the consumer replica's replica state (`orclreplicastate`).

The Replication Process

This section describes how the multimaster replication process adds, deletes, and modifies entries, and how it modifies DNs and RDNs. It contains these topics:

- [How the Multimaster Replication Process Adds a New Entry to a Consumer](#)
- [How the Multimaster Replication Process Deletes an Entry](#)
- [How the Multimaster Replication Process Modifies an Entry](#)
- [How the Multimaster Replication Process Modifies a Relative Distinguished Name](#)
- [How the Multimaster Replication Process Modifies a Distinguished Name](#)

How the Multimaster Replication Process Adds a New Entry to a Consumer

When the directory replication server adds a new entry to a consumer, it follows this change application process:

1. The directory replication server looks in the consumer for the DN of the parent of the target entry. Specifically, it does this by looking for a global unique identifier (GUID) assigned to the DN of the parent.
2. If the parent entry exists, then the directory replication server composes a DN for the new entry and places the new entry under its parent in the consumer. It then places the change entry in the purge queue.

If the change entry is not successfully applied on the first try, then:

The directory replication server places the new change entry in the retry queue, sets the number of retries to the configured maximum, and repeats the change application process.

If the change entry is not successfully applied on *all but the last* retry, then:

The directory replication server keeps the change entry in the retry queue, decrements the number of retries, and repeats the change application process.

If the change entry is not successfully applied on the last retry, then:

The directory replication server checks to see if the new entry is a duplicate of an existing entry.

If the change entry is a duplicate entry, then:

The directory replication server applies the following conflict resolution rules:

- The entry with the older creation time stamp is used.

- If both entries have the same creation time stamp, then the entry with the smaller GUID is used.

If the change entry is used, then the target entry is removed, the change is applied, and the change entry is placed in the purge queue.

If the target entry is used, then the change entry is placed in the purge queue.

If the change entry is not a duplicate entry, then:

The directory replication server places the change entry in the human intervention queue, and repeats the change application process at the interval you specified in the `orclHIQSchedule` parameter.

If the change entry is not successfully applied after it has been placed in the human intervention queue:

The directory replication server keeps the change in this queue, and repeats the change application process at specified intervals while awaiting action by the administrator. The administrator can use the Oracle Internet Directory Comparison and Reconciliation Tool and the human intervention queue manipulation tool to resolve the conflict.

How the Multimaster Replication Process Deletes an Entry

When the directory replication server deletes an entry from a consumer, it follows this change application process:

1. The directory replication server looks in the consumer for an entry with a GUID matching the one in the change entry.
2. If the matching entry exists in the consumer, then the directory replication server deletes it. It then places the change entry in the purge queue.

If the change entry is not successfully applied on the first retry, then:

The directory replication server places the change entry in the retry queue, sets the number of retries to the configured maximum, and repeats the change application process.

If the change entry is not successfully applied on *all but the last* retry, then:

The directory replication server keeps the change entry in the retry queue, decrements the number of retries, and repeats the change application process.

If the change entry is not successfully applied on the last retry, then:

The directory replication server places the change entry in the human intervention queue and repeats the change application process at specified intervals.

If the change entry is not successfully applied after it has been placed in the human intervention queue:

The directory replication server keeps the change entry in this queue, and repeats the change application process at specified intervals while awaiting action by the administrator. The administrator can use the Oracle Internet Directory Comparison and Reconciliation Tool and the human intervention queue manipulation tool to resolve the conflict.

How the Multimaster Replication Process Modifies an Entry

When the directory replication server modifies an entry in a consumer, it follows this change application process:

1. The directory replication server looks in the consumer for an entry with a GUID matching the one in the change entry.
2. If the matching entry exists in the consumer, then the directory replication server compares each attribute in the change entry with each attribute in the target entry.
3. The directory replication server then applies the following conflict resolution rules:
 - a. The attribute with the most recent modify time is used.
 - b. The attribute with the most recent version of the attribute is used—for example, version 1, 2, or 3.
 - c. The modified attribute on the host whose name is closest to the beginning of the alphabet is used.
4. The directory replication server applies the filtered modification, and places the change entry in the purge queue.

If the change entry is not successfully applied on the first try, then:

The directory replication server places the change entry in the retry queue, sets the number of retries to the configured maximum, and repeats the change application process.

If the change entry is not successfully applied on *all but the last* retry, then:

The directory replication server keeps the change entry in the retry queue, decrements the number of retries, and repeats the change application process.

If the change entry is not successfully applied by the last retry, then:

The directory replication server places the change entry in the human intervention queue and repeats the change application process at specified intervals.

If the change entry is not successfully applied after it has been placed in the human intervention queue:

The directory replication server keeps the change entry in this queue, and repeats the change application process at specified intervals while awaiting action by the administrator. You can use the Oracle Internet Directory Comparison and Reconciliation Tool and the Human Intervention Queue Manipulation Tool to resolve the conflict.

How the Multimaster Replication Process Modifies a Relative Distinguished Name

When the directory replication server modifies the RDN of an entry in a consumer, it follows this change application process:

1. The directory replication server looks in the consumer for the DN with a GUID that matches the GUID in the change entry.
2. If the matching entry exists in the consumer, then the directory replication server modifies the RDN of that entry and places the change entry in the purge queue.

If the change entry is not successfully applied on the first try, then:

The directory replication server places the change entry in the retry queue, sets the number of retries to the configured maximum, and repeats the change application process.

If the change entry is not successfully applied on *all but the last* retry, then:

The directory replication server keeps the change entry in the retry queue, decrements the number of retries, and repeats the change application process.

If the change entry is not successfully applied on the last retry, then:

The directory replication server places the change entry in the human intervention queue and checks to see if it is a duplicate of the target entry.

If the change entry is a duplicate entry, then:

The directory replication server applies the following conflict resolution rules:

- The entry with the older creation time stamp is used.
- If both entries have the same creation time stamp, then the entry with the smaller GUID is used.

If the change entry is used, then the target entry is removed, the change entry is applied, and then placed in the purge queue.

If the target entry is used, then the change entry is placed in the purge queue.

If the change entry is not a duplicate entry, then:

The directory replication server places the change entry in the human intervention queue, and repeats the change application process at specified intervals.

If the change entry is not successfully applied after it has been placed in the human intervention queue:

The directory replication server keeps the change entry in this queue, and repeats the change application process at specified intervals while awaiting action by the administrator. The administrator can use the Oracle Internet Directory Comparison and Reconciliation Tool and the Human Intervention Queue Manipulation Tool to resolve the conflict.

How the Multimaster Replication Process Modifies a Distinguished Name

When the directory replication server modifies the DN of an entry in a consumer, it follows this change application process:

1. The directory replication server looks in the consumer for the DN with a GUID that matches the GUID in the change entry.

The directory replication server also looks in the consumer for the parent DN with a GUID that matches the GUID of the new parent specified in the change entry.

2. If both the DN and the parent DN of the target entry exist in the consumer, then the directory replication server modifies the DN of that entry and places the change entry in the purge queue.

If the change entry is not successfully applied on the first try, then:

The directory replication server places the change entry in the retry queue, sets the number of retries to the configured maximum, and repeats the change application process.

If the change entry is not successfully applied on *all but the last* retry, then:

The directory replication server keeps the change entry in the retry queue, decrements the number of retries, and repeats the change application process.

If the change entry is not successfully applied by the last retry, then:

The directory replication server places the change entry in the human intervention queue and checks to see if it is a duplicate of the target entry.

If the change entry is a duplicate entry, then:

The directory replication server applies the following conflict resolution rules:

- The entry with the older creation time stamp is used.
- If both entries have the same creation time stamp, then the entry with the smaller GUID is used.

If the change entry is used, then the target entry is removed, the change entry is applied, and then placed in the purge queue.

If the target entry is used, then the change entry is placed in the purge queue.

If the change entry is not a duplicate entry, then:

The directory replication server places the change entry in the human intervention queue, and repeats the change application process at specified intervals.

If the change entry is not successfully applied after it has been placed in the human intervention queue:

The directory replication server keeps the change entry in this queue, and repeats the change application process at specified intervals while awaiting action by the administrator. The administrator can use the Oracle Internet Directory Comparison and Reconciliation Tool and the Human Intervention Queue Manipulation Tool to resolve the conflict.

Java Server Plug-in Developer's Reference

In response to both customer and internal requests, Oracle has added a Java API to the server plug-in framework for Oracle Internet Directory. Some of the new Oracle Internet Directory features, such as server chaining, were developed using the Java plug-in API.

This chapter contains the following sections:

- [Advantages of Java Plug-ins](#)
- [Setting Up a Java Plug-in](#)
- [Java Plug-in API](#)
- [Java Plug-in Error and Exception Handling](#)
- [Java Plug-in Debugging and Logging](#)
- [Java Plug-in Examples](#)

Advantages of Java Plug-ins

In addition to the advantages of the Java language itself, Java server plug-ins offer the following advantages over PL/SQL plug-ins:

- Bidirectional communication between the server and the plug-in
- The ability of the plug-in to return a search result
- Support for the moddn operation
- Better performance
- No knowledge of database required
- Enhanced security
- Enhanced debugging capability

Setting Up a Java Plug-in

Set up a Java plug-in as follows:

1. Create the standalone Java program using the pre-defined class definition and methods. You can implement the plug-in as a jar file or as a package.
2. Compile the plug-in file or package. Before compiling, ensure that your CLASSPATH is set to `$ORACLE_HOME/ldap/jlib/ospf.jar`. Make sure the compilation completes without error.

3. Place the class file, jar, or package in the pre-defined class location `$ORACLE_HOME/ldap/server/plugin`.
4. Register the Java plug-in by adding the plug-in configuration entry.
You can add the entry by using the command line or by using Oracle Directory Services Manager. For details, see ["Registering a Plug-in From the Command Line"](#) on page 43-6 and ["Managing Plug-ins by Using Oracle Directory Services Manager"](#) on page 43-9.

The jar file can have any name. The manifest file must contain the attribute `Main-Class`, followed by the name of the Java plug-in. For example:

```
Main-Class: myjavaplugin
```

The value of the `orclPluginName` attribute in the plug-in configuration entry must correspond with one of the following:

- The name of a class in a class file
- The fully qualified name of a class in a package
- A jar file name.

The value of the `orclPluginName` attribute determines where the server expects to find the class or jar file. [Table E-1](#) shows some examples.

Table E-1 Plug-in Names and Corresponding Paths

<code>orclPluginName</code>	Path
<code>myjavaplugin</code>	<code>ORACLE_HOME/ldap/server/plugin/myjavaplugin.class</code>
<code>myjavaplugin.jar</code>	<code>ORACLE_HOME/ldap/server/plugin/myjavaplugin.jar</code>
<code>my.package.myjavaplugin</code>	<code>ORACLE_HOME/ldap/server/plugin/my/package/myjavaplugin</code>

After you perform these steps, the server invokes the plug-in whenever the invocation criteria are met.

The classes included in the jar file must not occur in the environment. If they do, unexpected errors might occur. To correct this problem, remove the classes from the environment and restart the Oracle Internet Directory server. If the JAR or class file depends on other JAR files or class files, then append the dependent JAR files or paths of the class files to the `CLASSPATH` and restart the Oracle Internet Directory server.

You can control whether the server reloads the Java plug-in class every time the plug-in executes. If the value of the attribute `orclPluginClassReloadEnabled` is 1, the server reloads the plug-in class every time. If it is 0, the server loads the class only the first time the plug-in executes.

The path of the Oracle Internet Directory Server Plug-in Framework jar file is `$ORACLE_HOME/ldap/jlib/ospf.jar`.

Java Plug-in API

This section presents a high-level overview of the API and explains the role of the main classes and interfaces. For detailed information about all the Java server plug-in classes and interfaces, please see the Javadoc *Oracle Fusion Middleware Java API Reference for Oracle Internet Directory*.

This sections contains the following topics:

- [Communication Between the Server and Plug-in](#)
- [Java Plug-in Structure](#)
- [PluginDetail](#)
- [PluginResult](#)
- [ServerPlugin Interface](#)

Note: Do not use `System.exit()` in a Java plug-in. Doing so might lead to unpredictable behavior by the Oracle directory server.

Communication Between the Server and Plug-in

All Java plug-ins use the `ServerPlugin` interface for communication between the plug-in and the Oracle Internet Directory server. When the server invokes a Java plug-in, it constructs a `PluginDetail` object and passes information to the plug-in in that object. The plug-in constructs a `PluginResult` object. After it completes its task, the plug-in passes the `PluginResult` object back to the server. In some cases, the plug-in changes or adds to the information it received in the `PluginDetail` and passes the information back to the server in the `PluginResult` object. [Figure E-1](#) shows the communication between the Oracle Internet Directory server and the Java Plug-ins.

Figure E-1 *Communication Between the Server and the Java Plug-in*

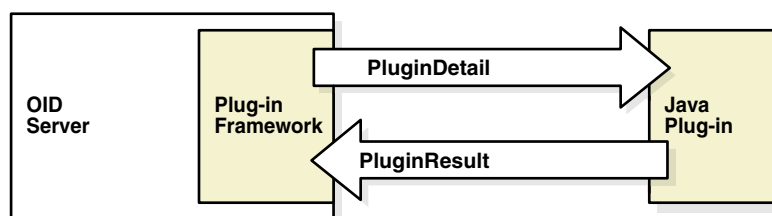

The Java plug-in can also use a `ServerLog` class to log messages in a log file.

Java Plug-in Structure

The general structure for a Java plug-in is:

```
public class Java_Plug-in_Class_Name {extends ServerPluginAdapter} {
    public PluginResult
    Name_of_ServerPlugin_Method(PluginDetail plgObj)
    throws Exception {
        // Plug-in Code
    }
}
```

or

```
public class Java_Plug-in_Class_Name {implements ServerPlugin} {
    public PluginResult
    Name_of_ServerPlugin_Method(PluginDetail plgObj)
    throws Exception {
        // Plug-in Code
    }
}
```

}

PluginDetail

The `PluginDetail` contains the following information:

- [Server](#)
- [LdapBaseEntry](#)
- [LdapOperation](#)
- [PluginFlexfield](#)

Server

This object contains metadata information about the Oracle Internet Directory Server where the plug-in is being executed. It contains the following information:

- Hostname
- Port
- `LdapContext`

The `Hostname` and the `Port` indicate the host and port on which the server is running.

The `LdapContext` object allows the plug-in to connect back to the server and inform it that the connection is being acquired from the plug-in. This is necessary, for example, in an `ldapbind` plug-in that performs an `ldapbind` itself. By connecting back to the server using this `LdapContext` object, the plug-in prevents the server from invoking the same plug-in, resulting in an infinite loop.

The following code fragment shows how the plug-in retrieves the `Server` object from the `PluginDetail` and connects back to the server:

```
// An LDAP Bind Plug-in
public class MyBindPlugin extends ServerPluginAdapter
{
    ...
    // Retrieve the Server Object from the PluginDetail
    Server srvObj = plgObj.getServer();
    .....
    // This bind will not result in the LDAP Bind Plug-in being called
    // in an infinite loop
    InitialLdapContext myConn =

(InitialLdapContext) srvObj.getLdapContextFromServerPlugin();
    myConn.bind(...);
    ...
}
```

See the Javadoc *Oracle Fusion Middleware Java API Reference for Oracle Internet Directory* for information about the methods used in the example.

LdapBaseEntry

The `LdapBaseEntry` contains the following information:

- DN
- Attributes

The server must send DN information for all of the operations, except `ldapadd`. The meaning of the DN for each operation is shown in [Table E-2](#).

Table E-2 The Meaning of the DN Information for Each LDAP Operation

Operation	Meaning of DN
ldapadd	No DN sent
ldapbind	The entry to which the directory server is attempting to bind
ldapcompare	The base entry on which to perform the compare
ldapdelete	For Pre and When timings, the entry which is to be deleted For Post timing, no DN sent
ldapmoddn	The base entry to be moved
ldapmodify	For Pre and When timings, the entry on which the modification is being performed For Post timing, the modified entry
ldapsearch	The base entry for the search

The Attributes are JNDI attributes.

The `LdapBaseEntry` has methods for accessing the DN and Attributes. For performance reasons, if the `LdapBaseEntry` is a group entry, and the entry cache capability is disabled, the attributes `uniquemember` and `member` are not accessible.

See Also: The Oracle Internet Directory chapter in Oracle Fusion Middleware Performance and Tuning Guide for information about performance tuning.

LdapOperation

Every plug-in is associated with one of the seven basic LDAP operations: add, bind, compare, delete, moddn, modify, or search. The `LdapOperation` object contains the following information, which is passed to all seven operations:

- Bind DN
- Server Controls
- Operation Result Code

The Bind DN is the DN of the identity that is requesting the LDAP operation. Server Controls is a vector that contains control information. If any server controls are passed to the server during an operation, then the control information is passed to the Java plug-in in the Server Controls. The meaning of the Operation Result Code depends on the timing of the operation, as shown in [Table E-2](#). Note that in the case of a `when_replace` operation, the plug-in can change the information in the Operation Result Code and pass it to the server in the `PluginResult`.

Table E-3 Behavior of Operation Result Code

Plug-in Timing	Meaning and Behavior of Operation Result Code
Pre	Not used
When	
When_replace	Error status of the LDAP operation performed by the plug-in. Output from the plug-in to the server.
Post	Error status of LDAP operation performed by the server. Input to the plug-in from the server.

`LdapOperation` also has methods for retrieving and modifying its contents.

Seven different classes representing the seven LDAP operations extend the `LdapOperation` class. Each of the subclasses includes class-specific information, in addition to the `LdapOperation` information. The classes and class-specific information are shown in [Table E-4](#). Each class name in [Table E-4](#) is a link to the section describing the details of that class:

Table E-4 Subclasses of `LdapOperation` and Class-specific information.

Class	Class-Specific information
AddLdapOperation	<code>LdapEntry</code>
BindLdapOperation	Bind Password
CompareLdapOperation	Attribute Name Attribute Value
DeleteLdapOperation	Delete DN
ModdnLdapOperation	New Parent DN New Relative DN Delete Old RDN New DN
ModifyLdapOperation	<code>LdapModification</code>
SearchLdapOperation	Filter Required Attributes Scope <code>SearchResultSet</code> (Not sent by server; created by plug-in to return data)

Each class has methods for creating, modifying, and retrieving its information. The class-specific information represents either input to the plug-in, output from the plug-in to the server, or both.

The rest of this section discusses the operation-specific classes in detail.

AddLdapOperation When invoking an `ldapadd` plug-in, the server constructs an `AddLdapOperation` object containing a `LdapEntry` object to pass information about the entry that is being added. The `LdapEntry` Object contains the following information:

- DN
- Attributes

The DN represents the DN of the entry to be added. The Attributes are the entry's JNDI Attributes. As [Table E-5](#) shows, for all operations except the post-operation, the plug-in can modify the information in the `LdapEntry` and return it to the server.

Table E-5 Behavior of `LdapEntry` Information for Each Plug-in Timing

Plug-in Timing	Behavior of <code>LdapEntry</code> Information
Pre	Both input and output. The plug-in can modify the information and return it to the server.
When	
When_replace	

Table E-5 (Cont.) Behavior of LdapEntry Information for Each Plug-in Timing

Plug-in Timing	Behavior of LdapEntry Information
Post	Input only.

BindLdapOperation The server passes the following information to an ldapbind plug-in:

- Bind Password
- Proxy Requester DN

Bind Password is the password for the bind. Proxy Requester DN is the DN of the identity requesting a Proxy Switch.

CompareLdapOperation The server passes the following information to an ldapcompare plug-in:

- Attribute Name
- Attribute Value

The Attribute Name is the name to be compared during the ldapcompare operation. As [Table E-6](#) shows, for all operations except the post-operation, the plug-in can modify the information in the Attribute Name and return it to the server.

Table E-6 Behavior of the AttributeName for Each Plug-in Timing

Plug-in Timing	Behavior of the Attribute Name Information
Pre	Both input and output. The plug-in can modify the information and return it to the server.
When	
When_replace	
Post	Input only.

The Attribute Value is the value to be compared during the ldapcompare operation. As [Table E-7](#) shows, for all operations except the post-operation, the plug-in can modify the information in the Attribute Value and return it to the server.

Table E-7 Behavior of the Attribute Value for Each Plug-in Timing

Plug-in Timing	Behavior of the Attribute Value Information
Pre	Both input and output. The plug-in can modify the information and return it to the server.
When	
When_replace	
Post	Input only.

DeleteLdapOperation The server passes the Delete DN object to an ldapdelete plug-in. This is the DN to be deleted. As [Table E-8](#) shows, for all operations except the post-operation, the plug-in can modify the information in the Delete DN and return it to the server.

Table E-8 Behavior of the Delete DN for Each Plug-in Timing

Plug-in Timing	Behavior of the DeleteDN Information
Pre When When_replace	Both input and output. The plug-in can modify the information and return it to the server.
Post	Input only.

ModdnLdapOperation The server passes the following information to ldapmoddn plug-ins:

- New Parent DN
- New Relative DN
- Delete Old RDN
- New DN

The New Parent DN contains the new parent of the RDN that was specified in the `LdapBaseEntry` of the `PluginDetail`. As [Table E-9](#) shows, for all operations except the post-operation, the plug-in can modify the information in the New Parent DN and return it to the server.

Table E-9 Behavior of New Parent DN Information for Each Plug-in Timing

Plug-in Timing	Behavior of the New Parent DN Information
Pre When When_replace	Both input and output. The plug-in can modify the information and return it to the server.
Post	Input only.

The New Relative DN is the new RDN that is to replace the RDN that was specified in the `LdapBaseEntry` of the `PluginDetail`. As [Table E-10](#) shows, for all operations except the post-operation, the plug-in can modify the information in the New Relative DN and return it to the server.

Table E-10 Behavior of New Relative Dn Information for Each Plug-in Timing

Plug-in Timing	Behavior of the New Relative Dn Information
Pre When When_replace	Both input and output. The plug-in can modify the information and return it to the server.
Post	Input only.

The Delete Old RDN value specifies whether the old RDN specified in the `LdapBaseEntry` of the `PluginDetail` is to be retained after it is replaced by the new relative DN. As [Table E-11](#) shows, for all operations except the post-operation, the plug-in can modify the value in Delete Old RDN and return it to the server.

Table E-11 Behavior of Delete Old RDN Information for Each Plug-in Timing

Plug-in Timing	Behavior of the Delete Old RDN Information
Pre	Both input and output. The plug-in can modify the information and return it to the server.
When	
When_replace	
Post	Input only.

The New DN specifies the target DN in of the ldapmoddn operation. This information is only an input from the server to the plug-in. The plug-in cannot modify this information and return it to the server.

ModifyLdapOperation The server passes an `LdapModification` object to `ldapmodify` plug-ins. The `LdapModification` object contains Modification Items, which are JNDI modification items. As [Table E-12](#) shows, for all operations except the post-operation, the plug-in can modify the information in the `LdapModification` and return it to the server.

Table E-12 Behavior of LdapModification Information for Each Plug-in Timing

Plug-in Timing	Behavior of the LdapModification Information
Pre	Both input and output. The plug-in can modify the information and return it to the server.
When	
When_replace	
Post	Input only.

SearchLdapOperation

The `SearchLdapOperation` object contains the following information:

- Filter
- Required Attributes
- Scope
- `SearchResultSet`

The Filter, Required Attributes, and Scope are passed by the server.

The Filter contains the LDAP search filter specified for the `ldapsearch` operation. This is only an input to the plug-in. The plug-in cannot modify this information and return it to the server.

The Required Attributes contains the required attributes specified for the `ldapsearch` operation. As [Table E-13](#) shows, for all operations except the post-operation, the plug-in can modify the information in the Required Attributes and return it to the server.

Table E-13 Behavior of the Required Attributes for Each Plug-in Timing

Plug-in Timing	Behavior of the Required Attributes Information
Pre	Both input and output. The plug-in can modify the information and return it to the server.
When	
When_replace	
Post	Input only.

The Scope contains the scope of the search to be performed by the `ldapsearch` operation. As [Table E-14](#) shows, for all operations except the post-operation, the plug-in can modify the information in the Scope and return it to the server.

Table E-14 Behavior of the Scope for Each Plug-in Timing

Plug-in Timing	Behavior of the Scope Information
Pre	Both input and output. The plug-in can modify the information and return it to the server.
When	
When_replace	
Post	Input only.

The `SearchResultSet` defines search results returned from the Java plug-in to the server. A plug-in performing an `ldapsearch` operation can construct this object. As [Table E-15](#) shows, only the when and when_replace plug-ins can return a `SearchResultSet` to the server.

Table E-15 Behavior of the SearchResultSet for Each Plug-in Timing

Plug-in Timing	Behavior of the SearchResultSet Information
Pre	The plug-in cannot return the object.
When	The plug-in can return this object to the server.
When_replace	
Post	The plug-in cannot return the object.

PluginFlexfield

When you register a plug-in, you can store custom information in the plug-in configuration entry. When the server invokes the plug-in, it passes this information to the plug-in in the `PluginFlexfield`.

There are three schema attributes for storing custom information in the configuration entry. You can store text information in the `orclPluginFlexfield` attribute. You can use sub-types to provide more meaning to the kind of custom information being stored. For example, you could use the subtype `orclPluginFlexfield;ad-host` to store the host name of an Active Directory server that the plug-in must connect to.

You can store a binary value in the `orclPluginBinaryFlexfield` attribute. You can only store one value in `orclPluginBinaryFlexfield` for a plug-in because the server does not support attribute subtypes for binary attributes.

You can use `orclPluginSecuredFlexfield` to store custom text information that must never be displayed in clear text. The value is stored and displayed in encrypted form. Be sure that Oracle Internet Directory has privacy mode enabled to ensure that users cannot retrieve this attribute in clear text. See ["Configuring Privacy of Retrieved Sensitive Attributes"](#) on page 27-7. You can use sub-types to provide more meaning to the kind of custom information being stored. Use the same subtype format as for `orclPluginFlexfield`.

When the server invokes the plug-in, it passes the information from the `orclPluginFlexfield`, `orclPluginBinaryFlexfield`, and `orclPluginSecuredFlexfield` to the plug-in in the `PluginFlexfield` object. The plug-in can interpret the information and use it. It cannot return the `PluginFlexfield` to the server.

In the following configuration entry example, subtypes of `orclPluginFlexfield` specify that the minimum password length is 8 characters, that the password must contain a digit, and that the password cannot contain repeated characters:

```
dn: cn=pre_add_replace,cn=plugin,cn=subconfigsentry
orclPluginFlexfield;minPwdLength: 8
orclPluginFlexfield;isDigitPwd: 1
orclPluginFlexfield;isRepeatCharsPwd: 0
objectclass: orclPluginConfig
objectclass: top
orclpluginname: MyJavaPwdCheckPlugin
orclplugintype: configuration
orclplugintiming: pre
orclpluginldapoperation: ldapadd
orclpluginenable: 1
orclpluginsubscriberdnlist: cn=users,dc=us,dc=oracle,dc=com
orclpluginattributelist: userpassword
orclPluginKind: Java
```

PluginResult

To return the results of its execution to the server, a Java plug-in constructs a `PluginResult` object and passes it back to the server. The `PluginResult` contains one object: an `LdapOperation` or one of its operation-specific subclasses. These objects were described in the section "[LdapOperation](#)" on page E-5. As explained in that section, for some operations and timings, the plug-in can modify the information in the "[LdapOperation](#)" subclass object it received in the `PluginDetail` and send that object back to the server in the `PluginResult`.

ServerPlugin Interface

All Java plug-ins use the `ServerPlugin` interface. The interface has pre-defined methods to communicate with the server. It has one method for each LDAP operation and timing. Each method takes a `PluginDetail` object as input and returns a `PluginResult` object back to the Oracle Internet Directory Server.

The `ServerPluginAdapter` class implements the `ServerPlugin` interface. The `ServerPluginAdapter` class has default (NULL) implementations of the `ServerPlugin` methods. This class enables you to code a Java plug-in without having to implement every method.

The rest of this section lists the `ServerPlugin` methods for each LDAP operation. It includes:

- [ServerPlugin Methods for Ldapbind](#)
- [ServerPlugin Methods for Ldapcompare](#)
- [ServerPlugin Methods for Ldapadd](#)
- [ServerPlugin Methods for Ldapmodify](#)
- [ServerPlugin Methods for Ldapmoddn](#)
- [ServerPlugin Methods for Ldapsearch](#)
- [ServerPlugin Methods for Ldapdelete](#)

ServerPlugin Methods for Ldapbind

```
public PluginResult pre_bind(PluginDetail pc) throws Exception;
```

```
public PluginResult when_bind_replace(PluginDetail pc) throws Exception;  
public PluginResult post_bind(PluginDetail pc) throws Exception;
```

ServerPlugin Methods for Ldapcompare

```
public PluginResult pre_compare(PluginDetail pc) throws Exception;  
public PluginResult when_compare_replace(PluginDetail pc) throws Exception;  
public PluginResult post_compare(PluginDetail pc) throws Exception;
```

ServerPlugin Methods for Ldapadd

```
public PluginResult pre_add(PluginDetail pc) throws Exception;  
public PluginResult when_add(PluginDetail pc) throws Exception;  
public PluginResult when_add_replace(PluginDetail pc) throws Exception;  
public PluginResult post_add(PluginDetail pc) throws Exception;
```

ServerPlugin Methods for Ldapmodify

```
public PluginResult pre_modify(PluginDetail pc) throws Exception;  
public PluginResult when_modify(PluginDetail pc) throws Exception;  
public PluginResult when_modify_replace(PluginDetail pc) throws Exception;  
public PluginResult post_modify(PluginDetail pc) throws Exception;
```

ServerPlugin Methods for Ldapmoddn

```
public PluginResult pre_moddn(PluginDetail pc) throws Exception;  
public PluginResult when_moddn(PluginDetail pc) throws Exception;  
public PluginResult when_moddn_replace(PluginDetail pc) throws Exception;  
public PluginResult post_moddn(PluginDetail pc) throws Exception;
```

ServerPlugin Methods for Ldapsearch

```
public PluginResult pre_search(PluginDetail pc) throws Exception;  
public PluginResult when_search(PluginDetail pc) throws Exception;  
public PluginResult when_search_replace(PluginDetail pc) throws Exception;  
public PluginResult post_search(PluginDetail pc) throws Exception;
```

ServerPlugin Methods for Ldapdelete

```
public PluginResult pre_delete(PluginDetail pc) throws Exception;  
public PluginResult when_delete(PluginDetail pc) throws Exception;  
public PluginResult when_delete_replace(PluginDetail pc) throws Exception;  
public PluginResult post_delete(PluginDetail pc) throws Exception;Java plug-in API
```

Java Plug-in Error and Exception Handling

The Oracle Internet Directory server catches all unhandled exceptions during the execution of the plug-in. The exception stack trace and message for each exception is logged in the server log file. These exceptions fall into three categories:

- Run-time errors and exceptions occur due to faulty plug-in code or logic. The server catches all run-time errors and exceptions, including `NullPointerException`s, raised during the execution of the Java plug-in. These errors and exceptions are logged in the server log file.
- Expected exceptions thrown by the plug-in are logged in the Oracle Internet Directory server log file. In addition, a plug-in can catch an exception and throw it back to the server to log it in the server log file.
- A plug-in can use the `PluginException` class to raise an error. The error message passed to the server with the `PluginException` object or its subclasses

is passed on to the LDAP client. The server also logs this message in the server log file along with the exception stack trace and message.

This section includes three examples. They are:

- [Run-time Exception Example](#)
- [Run-time Error Example](#)
- [PluginException Example](#)

Run-time Exception Example

The log entry for a typical exception raised during execution of a plug-in looks like this:

```
...
06:17:03 *
  ERROR * gslpg_exceptionHndlr * Exception Message : Error
  ERROR * gslpg_exceptionHndlr * Exception Stack Trace :
        MyCompareJavaPlugin.post_compare(Prog2.java:75)
END

BEGIN
2004/10/19:01:52:13 *
  ServerWorker (REG):4 * ConnID:0 * OpID:1 * OpName:compare
  ERROR * gslpg_exceptionHndlr * Exception Stack Trace :
        java.lang.NullPointerException
        java.util.Hashtable.put (Hashtable.java:393)
        oracle.ldap.ospf.PluginDetail.put (PluginDetail.java:41)
END
```

Run-time Error Example

The error occurred because the plug-in MyJavaPlugin did not exist in the \$ORACLE_HOME/ldap/server/plugin directory. The log file entry looks like this:

```
BEGIN
2004/10/19:01:52:13 *
  ServerWorker (REG):4 * ConnID:0 * OpID:1 * OpName:compare
  ERROR * gslpg_exceptionHndlr * Exception Stack Trace :
        java.lang.NoClassDefFoundError: MyJavaPlugin
END
```

PluginException Example

The Oracle Internet Directory server returns the standard plug-in error message to the LDAP client along with the additional error message if a `PluginException` object is thrown back to the server. The error displayed by the LDAP client looks something like this:

```
ldap_compare: UnKnown Error Encountered
ldap_compare: additional info: Error Message returned by the Java Plug-in
```

Java Plug-in Debugging and Logging

A plug-in can maintain its own log file and log to it in real time. In addition, a plug-in can log debug messages in the Oracle Internet Directory server log file during

execution by using the `ServerLog` class. The method for logging messages in the `ServerLog` class is:

```
public static void log(String message);
```

Messages logged by the `ServerLog.log()` method are preceded by the string:

```
* Server Java Plug-in *
```

For example:

```
2006/05/11:01:11:28 * ServerWorker (REG):7
  ConnID:241 * msgID:2 * OpID:1 * OpName:bind
01:11:28 * Server Java Plug-in * MESSAGE FROM PLUGIN
01:11:28 * Server Java Plug-in * Bind DN :
  cn=ad_user,cn=oiddvusers,cn=oraclecontext,dc=us,dc=oracle,dc=com
```

To log plug-in debug messages to the server log, you must start the Oracle Internet Directory server using one of the following debug levels:

Table E-16 Debug Levels for Java Plug-in Logging

Oracle Internet Directory Server Debug Level	Debug Level Meaning
134217728	All Java plug-in debug messages and internal server messages related to the Java plug-in framework
268435456	All messages passed by a Java plug-in using the <code>ServerLog</code> object.
402653184	Both of the above

The `ServerLog.log()` method is thread safe. Execution of this method can degrade performance.

Java Plug-in Examples

This sections includes two examples. They are:

- [Example 1: Password Validation Plug-in](#)
- [Example 2: External Authentication Plug-in for Active Directory](#)

Note: Do not use `System.exit()` in a Java plug-in. Doing so might lead to unpredictable behavior by the Oracle directory server.

Example 1: Password Validation Plug-in

This example illustrates a Java plug-in that validates a `userPassword` before the `ldapmodify` operation. A `pre` Java plug-in is registered with the Oracle Internet Directory server. The plug-in configuration includes the minimum password length to be checked for in the plug-in. This information is registered in the plug-in configuration entry using an `orclPluginFlexfield` attribute. The subtype `minPwdLength` specifies the minimum length. This information is passed to the plug-in using the `PluginFlexfield`. The `orclPluginName` specifies the name of the Java Plug-in to be invoked by the Oracle Internet Directory server.

The input to the plug-in is a `PluginDetail` and the output from the plug-in is a `PluginResult`.

Password Validation Plug-in Configuration Entry

```
dn: cn=checkuserpassword,cn=plugin,cn=subconfigsubentry
orclPluginFlexfield:minPwdLength: 8
objectclass: orclPluginConfig
objectclass: top
orclpluginname: CheckPassword
orclplugintype: configuration
orclplugintiming: pre
orclpluginldapoperation: ldapmodify
orclpluginenable: 1
orclpluginsubscriberdnlist: cn=users,dc=us,dc=oracle,dc=com
orclpluginattributelist: userPassword
orclPluginKind: Java
```

Password Validation Plug-in Code Example

```
import java.io.*;
import java.lang.*;
import java.util.*;
import javax.naming.*;
import javax.naming.directory.*;
import oracle.ldap.ospf.*;
/**
 * This PRE modify plug-in will check whether the "userPassword"
 * is greater than 8 characters in length
 */
public class CheckPassword extends ServerPluginAdapter {

    // This PRE modify plug-in takes in a PluginDetail Object
    // and returns a PluginResult Object
    public PluginResult pre_modify(PluginDetail plgObj)
        throws Exception
    {
        try {
            // Retrieve the LdapOperation Object from the PluginDetail
            ModifyLdapOperation opObj = (ModifyLdapOperation)
plgObj.getLdapOperation();

            // Retrieve the LdapModification Object from the LdapOperation
            LdapModification modObj = opObj.getLdapModification();

            // Retrieve the PluginFlexfield Object from the PluginDetail
            PluginFlexfield flxFldObj = plgObj.getPluginFlexfield();

            // Retrieve the custom information from the PluginFlexfield
            // Get the minimum password length
            String passwdlength =
                flxFldObj.getFlexfield("minPwdLength");

            // Create a Result Object to return to the OID server
            PluginResult plgResObj = new PluginResult();

            // Check if the LdapModification Object is a NULL
            // set the appropriate error and error message
            if (modObj==null)
            {
                throw new PluginException("CheckPassword Plug-in Execution
```

```
Error");
    }

    // Retrieve the "userPassword" Attribute Value
    ModificationItem modItem = modObj.getModificationItemAt(0);
    BasicAttribute attr = (BasicAttribute)modItem.getAttribute();
    String attrval = null;
    if ((attr.getID()).equals("userpassword"))
    attrval = attr.get(0);

    // Check for the password length and set appropriate error
    // and error message
    if (attrval.length() < Integer.parseInt(passwdlength))
    {
        throw new PluginException("userPassword is less than 8
characters");
    }

    // Return the PluginResult Object to the OID Server
    return plgResObj;
}
// Catch any unexpected exception which may occur and throw
// it back to the OID server to log it
catch (Exception e)
{
    throw e;
}
}
```

Example 2: External Authentication Plug-in for Active Directory

This example illustrates an external authentication plug-in for Active Directory. When a client requests an `ldapcompare` operation for `userPassword`, the server invokes this Java plug-in to authenticate the user against Active Directory.

External Authentication Plug-in Configuration Entry

```
dn: cn=when_rep_comp,cn=plugin,cn=subconfigsubentry
orclpluginsubscriberdnlist: cn=users,dc=us,dc=oracle,dc=com;
orclpluginflexfield;ad-host: dlin-pc2.us.example.com
orclpluginflexfield;ad-port: 3060
orclpluginflexfield;ad-su-dn: administrator@dlin.net
orclpluginflexfield;ad-su-passwd: password1
objectclass: orclPluginConfig
objectclass: top
orclpluginname: ExtAuthAD
orclplugintype: configuration
orclplugintiming: when
orclpluginisreplace: 1
orclpluginldapoperation: ldapcompare
orclpluginversion: 1.0.1
cn: when_rep_comp
orclpluginkind: Java
orclpluginenable: 1
```

External Authentication Plug-in Code

```
public class ExtAuthAD extends ServerPluginAdapter {
```



```

public PluginResult when_compare_replace(PluginDetail plgObj)
    throws Exception {
    try {

        // Retrieve the LdapOperation from the PluginDetail
        CompareLdapOperation opObj =
            (CompareLdapOperation) plgObj.getLdapOperation();
        String baseDn = plgObj.getLdapBaseEntry().getDN();

        // Retrieve the Base DN, Attribute and Attribute Value
        String bdn = baseDn.substring(0,
            baseDn.lastIndexOf("cn=users,dc=us,dc=oracle,dc=com")-1)
            +",cn=users,dc=dlin,dc=net";
        String ban = opObj.getAttributeName();
        String bav = opObj.getAttributeValue().toString();

        // Retrieve the AD Information from the PluginFlexfield
        PluginFlexfield flxObj = plgObj.getPluginFlexfield();
        String adhost = flxObj.getFlexfield("ad-host");
        String adport = flxObj.getFlexfield("ad-port");
        String adsudn = flxObj.getFlexfield("ad-su-dn");
        String adsupasswd = flxObj.getFlexfield("ad-su-passwd");

        // Create a PluginResult Object to return to the OID server
        PluginResult plgResObj = new PluginResult();

        // Create a Hashtable with values required to connect to AD
        Hashtable env = new Hashtable();

        env.put(Context.INITIAL_CONTEXT_FACTORY,
            "com.sun.jndi.ldap.LdapCtxFactory");
        env.put(Context.PROVIDER_URL, "ldap://" + adhost + ":" + adport);
        env.put(Context.SECURITY_AUTHENTICATION, "simple");
        env.put(Context.SECURITY_PRINCIPAL, bdn);
        env.put(Context.SECURITY_CREDENTIALS, bav);

        // Try to connect to AD
        DirContext dirContext = null;
        try {
            dirContext = new InitialDirContext(env);
            if (dirContext != null) {
                // User has been successfully authenticated, add the appropriate
                // result code to the LdapOperation
                opObj.setOperationResultCode(6);
            }
        }
        catch(NamingException ne) {
            // Unable to connect to the AD directory server with the given
            // credentials, add the appropriate result code to the LdapOperation
            opObj.setOperationResultCode(5);
        }

        // Add the LdapOperation to the PluginResult
        plgResObj.setLdapOperation(opObj);

        // Return the PluginResult
        return plgResObj;
    } catch(Exception e) {

```

```
        // In case of any unexpected errors in the plug-in, throw the Exception
        // back to the OID server to log it
        throw e;
    }
}
```

PL/SQL Server Plug-in Developer's Reference

This appendix explains how to use the plug-in framework in PL/SQL.

This appendix contains these topics:

- [Designing, Creating, and Using PL/SQL Server Plug-ins](#)
- [Examples of PL/SQL Plug-ins](#)
- [Binary Support in the PL/SQL Plug-in Framework](#)
- [Database Object Types Defined](#)
- [Specifications for PL/SQL Plug-in Procedures](#)

Designing, Creating, and Using PL/SQL Server Plug-ins

This section contains these topics:

- [PL/SQL Plug-in Caveats](#)
- [Creating PL/SQL Plug-ins](#)
- [Compiling PL/SQL Plug-ins](#)
- [Managing PL/SQL Plug-ins](#)
- [Enabling and Disabling PL/SQL Plug-ins](#)
- [Exception Handling in a PL/SQL Plug-in](#)
- [PL/SQL Plug-in LDAP API](#)
- [PL/SQL Plug-in and Database Tools](#)
- [PL/SQL Plug-in Security](#)
- [PL/SQL Plug-in Debugging](#)
- [PL/SQL Plug-in LDAP API Specifications](#)
- [Database Limitations](#)

PL/SQL Plug-in Caveats

The following caveats apply to PL/SQL plug-ins:

Types of PL/SQL Plug-in Operations

A PL/SQL plug-in can only be associated with `ldapbind`, `ldapadd`, `ldapmodify`, `ldapcompare`, `ldapsearch`, and `ldapdelete` operations. You cannot associate a PL/SQL plug-in with `moddn`. If you must associate a plug-in with `moddn`, you must use a Java plug-in.

Naming PL/SQL Plug-ins

Plug-in names (PL/SQL package names) must be unique if they share the same database schema with other plug-ins or stored procedures. But plug-ins can share names with other database schema objects such as tables and views. This kind of sharing is not, however, recommended.

Creating PL/SQL Plug-ins

Creating a PL/SQL plug-in module is like creating a PL/SQL package. Both have a specification part and a body part. The directory, not the plug-in, defines the plug-in specification because the specification serves as the interface between Oracle Internet Directory and the custom plug-in.

For security reasons and for the integrity of the LDAP server, you can compile PL/SQL plug-ins only in the ODS database schema. You must compile them in the database that serves as the back end database of Oracle Internet Directory.

Package Specifications for Plug-in Module Interfaces

Different plug-ins have different package specifications. As [Table F-1](#) shows, you can name the plug-in package. You must, however, follow the signatures defined for each type of plug-in procedure. See "[Specifications for PL/SQL Plug-in Procedures](#)" for details.

Table F-1 Plug-in Module Interface

Plug-in Item	User Defined	Oracle Internet Directory-Defined
Plug-in Package Name	X	
Plug-in Procedure Name		X
Plug-in Procedure Signature		X

[Table F-2](#) names the different plug-in procedures. In addition, it lists and describes the parameters that these procedures use.

Table F-2 Operation-Based and Attribute-Based Plug-in Procedure Signatures

Invocation Context	Procedure Name	IN Parameters	OUT Parameters
Before <code>ldapbind</code>	<code>PRE_BIND</code>	<code>ldapcontext</code> , Bind DN, Password	return code, error message
With <code>ldapbind</code> but replacing the default server behavior	<code>WHEN_BIND_REPLACE</code>	<code>ldapcontext</code> , bind result, DN, userpassword	bind result, return code, error message
After <code>ldapbind</code>	<code>POST_BIND</code>	<code>ldapcontext</code> , Bind result, Bind DN, Password	return code, error message
Before <code>ldapmodify</code>	<code>PRE_MODIFY</code>	<code>ldapcontext</code> , DN, Mod structure	return code, error message

Table F-2 (Cont.) Operation-Based and Attribute-Based Plug-in Procedure Signatures

Invocation Context	Procedure Name	IN Parameters	OUT Parameters
With ldapmodify	WHEN_MODIFY	ldapcontext, DN, Mod structure	return code, error message
With ldapmodify but replacing the default server behavior	WHEN_MODIFY_REPLACE	ldapcontext, DN, Mod structure	return code, error message
After ldapmodify	POST_MODIFY	ldapcontext, Modify result, DN, Mod structure	return code, error message
Before ldapcompare	PRE_COMPARE	ldapcontext, DN, attribute, value	return code, error message
With ldapcompare but replacing the default server behavior	WHEN_COMPARE_REPLACE	ldapcontext, Compare result, DN, attribute, value	compare result, return code, error message
After ldapcompare	POST_COMPARE	ldapcontext, Compare result, DN, attribute, value	return code, error message
Before ldapadd	PRE_ADD	ldapcontext, DN, Entry	return code, error message
With ldapadd	WHEN_ADD	ldapcontext, DN, Entry	return code, error message
With ldapadd but replacing the default server behavior	WHEN_ADD_REPLACE	ldapcontext, DN, Entry	return code, error message
After ldapadd	POST_ADD	ldapcontext, Add result, DN, Entry	return code, error message
Before ldapdelete	PRE_DELETE	ldapcontext, DN	return code, error message
With ldapdelete	WHEN_DELETE	ldapcontext, DN	return code, error message
With ldapdelete but replacing the default server behavior	WHEN_DELETE	ldapcontext, DN	return code, error message
After ldapdelete	POST_DELETE	ldapcontext, Delete result, DN	return code, error message
Before ldapsearch	PRE_SEARCH	ldapcontext, Base DN, scope, filter	return code, error message
After ldapsearch	POST_SEARCH	Ldap context, Search result, Base DN, scope, filter	return code, error message

See Also:

- ["Error Handling"](#) on page F-5 for valid values for the return code and error message.
- ["Specifications for PL/SQL Plug-in Procedures"](#) on page F-21 for complete supported procedure signatures.

Compiling PL/SQL Plug-ins

You must compile the plug-in module against the same database that serves as the Oracle Internet Directory back end database. Plug-ins are the same as PL/SQL stored procedures. A PL/SQL anonymous block is compiled each time it is loaded into memory. Compilation consists of these stages:

1. Syntax checking: PL/SQL syntax is checked, and a parse tree is generated.
2. Semantic checking: Type checking and further processing on the parse tree.
3. Code generation: The pcode is generated.

If errors occur during the compilation of a plug-in, the plug-in is not created. You can use the `SHOW ERRORS` statement in SQL*Plus or Enterprise Manager to see any compilation errors when you create a plug-in, or you can `SELECT` the errors from the `USER_ERRORS` view.

All plug-in modules must be compiled in the ODS database schema.

Dependencies

Compiled plug-ins have dependencies. They become invalid if an object depended upon, such as a stored procedure or function called from the plug-in body, is modified. Plug-ins that are invalidated for dependency reasons must be recompiled before the next invocation.

Recompiling Plug-ins

Use the `ALTER PACKAGE` statement to manually recompile a plug-in. For example, the following statement recompiles the `my_plugin` plug-in:

```
ALTER PACKAGE my_plugin COMPILE PACKAGE;
```

Managing PL/SQL Plug-ins

This section explains how to modify and debug plug-ins.

Modifying Plug-ins

Like a stored procedure, a plug-in cannot be explicitly altered. It must be replaced with a new definition.

When replacing a plug-in, you must include the `OR REPLACE` option in the `CREATE PACKAGE` statement. The `OR REPLACE` option enables a new version of an existing plug-in to replace an older version without having an effect on grants made for the original version of the plug-in.

Alternatively, the plug-in can be dropped using the `DROP PACKAGE` statement, and you can rerun the `CREATE PACKAGE` statement.

If the plug-in name (the package name) is changed, you must register the new plug-in again.

Debugging Plug-ins

You can debug a plug-in using the same facilities available for PL/SQL stored procedures.

Enabling and Disabling PL/SQL Plug-ins

To turn the plug-in on or off, modify the value of `orclPluginEnable` in the plug-in configuration object. For example, modify the value of `orclPluginEnable` in `cn=post_mod_plugin`, `cn=plugins`, `cn=subconfigsubentry` to be 1 or 0.

Exception Handling in a PL/SQL Plug-in

Each of the procedures in a PL/SQL plug-in must have an exception handling block that handles errors intelligently and, if possible, recovers from them.

Error Handling

Oracle Internet Directory requires that the return code (`rc`) and error message (`errmsg`) be set correctly in the plug-in procedures.

Table F-3 provides the values that are valid for the return code.

Table F-3 Valid Values for the plug-in Return Code

Error Code	Description
0	Success
Any number greater than zero	Failure
-1	Warning

The `errmsg` parameter is a string value that can pass a user's custom error message back to Oracle Internet Directory server. The size limit for `errmsg` is 1024 bytes. Each time Oracle Internet Directory runs the plug-in program, it examines the return code to determine if it must display the error message.

If, for example, the value for the return code is 0, the error message value is ignored. If the value of the return code is -1 or greater than zero, the following message is either logged in the log file or displayed in standard output if the request came from LDAP command-line tools:

```
ldap addition info: customized error
```

Program Control Handling between Oracle Internet Directory and Plug-ins

Table F-4 shows where plug-in exceptions occur and how the directory handles them.

Table F-4 Program Control Handling when a Plug-in Exception Occurs

Plug-in Exception Occurred in	Oracle Internet Directory Server Handling
PRE_BIND, PRE_MODIFY, PRE_ADD, PRE_SEARCH, PRE_COMPARE, PRE_DELETE	Depends on return code. If the return code is: <ul style="list-style-type: none"> ■ Greater than zero (error), then no LDAP operation is performed ■ -1 (warning), then proceed with the LDAP operation
POST_BIND, POST_MODIFY, POST_ADD, POST_SEARCH, WHEN_DELETE	LDAP operation is completed. There is no rollback.
WHEN_MODIFY, WHEN_ADD, WHEN_DELETE	Rollback the LDAP operation

Table F-5 shows how the directory responds when an LDAP operation fails.

Table F-5 Program Control Handling when an LDAP Operation Fails

LDAP Operation Fails in	Oracle Internet Directory Server Handling
PRE_BIND, PRE_MODIFY, PRE_ADD, PRE_SEARCH, WHEN_DELETE	Pre-operation plug-in is completed. There is no rollback.
POST_BIND, POST_ MODIFY, POST_ADD, POST_SEARCH, WHEN_ DELETE	Proceed with post-operation plug-in. The LDAP operation result is one of the IN parameters.
WHEN_MODIFY, WHEN_ ADD, WHEN_DELETE	When types of plug-in changes are rolled back.
WHEN	Changes made in the plug-in program body are rolled back.

PL/SQL Plug-in LDAP API

There are different methods for providing API access:

- Enable a user to utilize the standard LDAP PL/SQL APIs. Note though that, if program logic is not carefully planned, an infinite loop in plug-in execution can result.
- Oracle Internet Directory provides the Plug-in LDAP API. This plug-in does not cause a series of plug-in actions in the directory server if there are plug-ins configured and associated with the LDAP request.

In the Plug-in LDAP API, the directory provides APIs for connecting back to the directory server designated in the plug-in module. You must use this API if you want to connect to the server that is executing the plug-in. If you want to connect to an external server, you can use the DBMS_LDAP API.

Within each plug-in module, an `ldapcontext` is passed from the Oracle directory server. When the Plug-in LDAP API is called, `ldapcontext` is passed for security and binding purposes. When binding with this `ldapcontext`, Oracle Internet Directory recognizes that the LDAP request is coming from a plug-in module. For this type of plug-in bind, the directory does not trigger any subsequent plug-ins. It handles the plug-in bind as a super-user bind. Use this plug-in bind with discretion.

See Also: ["PL/SQL Plug-in LDAP API Specifications"](#) on page F-7.

PL/SQL Plug-in and Database Tools

Bulk tools do not support server plug-ins.

PL/SQL Plug-in Security

Some Oracle Internet Directory server plug-ins require that you supply the code that preserves tight security. For example, if you replace the directory's `ldapcompare` or `ldapbind` operation with your own plug-in module, you must ensure that your implementation of this operation does not omit any functionality on which security relies.

To ensure tight security, the following must be done:

- Create the plug-in packages
- Only the LDAP administrator can restrict the database user

- Use the access control list (ACL) to set the plug-in configuration entries to be accessed only by the LDAP administrator
- Be aware of the program relationship between different plug-ins

PL/SQL Plug-in Debugging

Use the plug-in debugging mechanism for Oracle Internet Directory to examine the process and content of plug-ins. The following commands control the operation of the server debugging process.

- To set up plug-in debugging, run this command:

```
% sqlplus ods @$ORACLE/ldap/admin/oidspdsu.pls
```
- To enable plug-in debugging, run this command:

```
% sqlplus ods @$ORACLE/ldap/admin/oidspdon.pls
```
- After enabling plug-in debugging, you can use this command in the plug-in module code:

```
plg_debug('debuggingmessage');
```

The resulting debug message is stored in the plug-in debugging table.

- To disable debugging, run this command:

```
% sqlplus ods @$ORACLE/ldap/admin/oidsp dof.pls
```
- To display the debug messages that you put in the plug-in module, run this command:

```
% sqlplus ods @$ORACLE/ldap/admin/oidsp dsh.pls
```
- To delete all of the debug messages from the debug table, run this command:

```
% sqlplus ods @$ORACLE/ldap/admin/oidsp dde.pls
```

PL/SQL Plug-in LDAP API Specifications

Here is the package specification that Oracle Internet Directory provides for the PL/SQL Plug-in LDAP API:

```
CREATE OR REPLACE PACKAGE LDAP_PLUGIN AS
  SUBTYPE SESSION IS RAW(32);

  -- Initializes the LDAP library and return a session handler
  -- for use in subsequent calls.
  FUNCTION init (ldappluginctx IN ODS.plugincontext)
    RETURN SESSION;

  -- Synchronously authenticates to the directory server using
  -- a Distinguished Name and password.
  FUNCTION simple_bind_s (ldappluginctx IN ODS.plugincontext,
                        ld              IN SESSION)
    RETURN PLS_INTEGER;

  -- Get requester info from the plug-in context
  FUNCTION get_requester (ldappluginctx IN ODS.plugincontext)
    RETURN VARCHAR2;
END LDAP_PLUGIN;
```

Database Limitations

Oracle Internet Directory can use several different versions of the Oracle Database for storing directory data. These include Oracle Database Release 2, v9.2.0.6 or later and Oracle Database 10g, v10.1.0.4 or later.

The following plug-in features are not supported in the directory server running against Oracle Database Release 2:

- Windows Domain external authentication plug-in.
- The `simple_bind_s()` function of the `LDAP_PLUGIN` package provided as the Oracle Internet Directory PL/SQL PLUGIN API for connecting back to the directory server as part of plug-in definitions.

Examples of PL/SQL Plug-ins

This section presents two sample plug-ins. One logs all `ldapsearch` commands. The other synchronizes two directory information trees (DITs).

Example 1: Search Query Logging

Situation: A user wants to know if it is possible to log all of the `ldapsearch` commands.

Solution: Yes. The user can use the `post_ldapsearch` configuration plug-in for this purpose. They can either log all of the requests or only those that occur under the DNs being searched.

To log all the `ldapsearch` commands:

1. Log all of the `ldapsearch` results into a database table. This log table has these columns:
 - timestamp
 - baseDN
 - search scope
 - search filter
 - required attribute
 - search result

Use this SQL script to create the table:

```
drop table search_log;
create table search_log
(timestamp varchar2(50),
basedn varchar2(256),
searchscope number(1),
searchfilter varchar2(256);
searchresult number(1));
drop table simple_tab;
create table simple_tab (id NUMBER(7), dump varchar2(256));
DROP sequence seq;
CREATE sequence seq START WITH 10000;
commit;
```

2. Create the plug-in package specification.

```
CREATE OR REPLACE PACKAGE LDAP_PLUGIN_EXAMPLE1 AS
```

```

PROCEDURE post_search
(ldapplugincontext IN ODS.plugincontext,
result            IN INTEGER,
basedn           IN VARCHAR2,
scope            IN INTEGER,
filterStr        IN VARCHAR2,
requiredAttr     IN ODS.strCollection,
rc               OUT INTEGER,
errmsg           OUT VARCHAR2
);
END LDAP_PLUGIN_EXAMPLE1;
/

```

3. Create the plug-in package body.

```

CREATE OR REPLACE PACKAGE BODY LDAP_PLUGIN_EXAMPLE1 AS
PROCEDURE post_search
(ldapplugincontext IN ODS.plugincontext,
result            IN INTEGER,
basedn           IN VARCHAR2,
scope            IN INTEGER,
filterStr        IN VARCHAR2,
requiredAttr     IN ODS.strCollection,
rc               OUT INTEGER,
errmsg           OUT VARCHAR2
)
IS
BEGIN
    INSERT INTO simple_tab VALUES
(to_char(sysdate, 'Month DD, YYYY HH24:MI:SS'), basedn, scope, filterStr,
result);
    -- The following code segment demonstrate how to iterate
    -- the ODS.strCollection
    FOR l_counter1 IN 1..requiredAttr.COUNT LOOP
        INSERT INTO simple_tab
            values (seq.NEXTVAL, 'req attr ' || l_counter1 || ' = ' ||
                requiredAttr(l_counter1));
    END LOOP;
    rc := 0;
    errmsg := 'no post_search plug-in error msg';
    COMMIT;
EXCEPTION
    WHEN others THEN
        rc := 1;
        errmsg := 'exception: post_search plug-in';
END;
END LDAP_PLUGIN_EXAMPLE1;
/

```

4. Register the plug-in entry in Oracle Internet Directory.

```

dn: cn=post_search,cn=plugin,cn=subconfigsubentry
objectclass: orclPluginConfig
objectclass: top
orclPluginName: ldap_plugin_example1
orclPluginType: configuration
orclPluginTiming: post
orclPluginLDAPOperation: ldapsearch
orclPluginEnable: 1
orclPluginVersion: 1.0.1
cn: post_search

```

```
orclPluginKind: PLSQL
```

Using the `ldapadd` command-line tool to add this entry:

```
% ldapadd -p port_number -h host_name -D bind_dn -q -v \
-f register_post_search.ldif
```

Example 2: Synchronizing Two DITs

Situation: There are two interdependent products under `cn=Products`, `cn=oraclecontext`. This interdependency extends down to the users in these products' containers. If a user in the first DIT (product 1) is deleted, the corresponding user in the other DIT (product 2) must be deleted.

Is it possible to set a trigger that, when the user in the first DIT is deleted, calls or passes a trigger to delete the user in the second DIT?

Solution: Yes, we can use the `post ldapdelete` operation plug-in to handle the second deletion occurring in the second DIT.

If the first DIT has the naming context of `cn=DIT1, cn=products, cn=oraclecontext` and the second DIT has the naming context of `cn=DIT2, cn=products, cn=oraclecontext`, the two users share the same ID attribute. Inside of the `post ldapdelete` plug-in module, we can use `LDAP_PLUGIN` and `DBMS_LDAP` APIs to delete the user in the second DIT.

We must set `orclPluginSubscriberDNList` to `cn=DIT1, cn=products, cn=oraclecontext`, so that whenever we delete entries under `cn=DIT1, cn=products, cn=oraclecontext`, the plug-in module is invoked.

Note: When you use a `post ldapmodify` plug-in to synchronize changes between two Oracle Internet Directory nodes, you cannot push all the attributes from one node to the other. This is because the changes (mod structure) captured in the plug-in module include operational attributes. These operational attributes are generated on each node and cannot be modified by using the standard LDAP methods.

When writing your plug-in program, exclude the following operational attributes from synchronization: `authPassword`, `creatorsname`, `createtimestamp`, `modifiersname`, `modifytimestamp`, `orcllastlogintime`, `pwdchangedtime`, `pwdfailuretime`, `pwdaccountlockedtime`, `pwdexpirationwarned`, `pwdreset`, `pwdhistory`, `pwdgraceusetime`.

1. Assume that the entries under both DITs have been added to the directory. For example, the entry `id=12345, cn=DIT1, cn=products, cn=oraclecontext` is in DIT1, and `id=12345, cn=DIT2, cn=products, cn=oraclecontext` is in DIT2.
2. Create the plug-in package specification.

```
CREATE OR REPLACE PACKAGE LDAP_PLUGIN_EXAMPLE2 AS
PROCEDURE post_delete
(ldapplugincontext IN ODS.plugincontext,
result IN INTEGER,
dn IN VARCHAR2,
```

```

rc          OUT INTEGER,
errmsg OUT VARCHAR2
);
END LDAP_PLUGIN_EXAMPLE2;
/

```

3. Create the plug-in package body.

```

CREATE OR REPLACE PACKAGE BODY LDAP_PLUGIN_EXAMPLE2 AS
PROCEDURE post_delete
(ldapplugincontext IN ODS.plugincontext,
result IN INTEGER,
dn IN VARCHAR2,
rc OUT INTEGER,
errmsg OUT VARCHAR2
)
IS
retval PLS_INTEGER;
my_session DBMS_LDAP.session;
newDN VARCHAR2(256);
BEGIN
retval := -1;
my_session := LDAP_PLUGIN.init(ldapplugincontext);
-- bind to the directory
retval := LDAP_PLUGIN.simple_bind_s(ldapplugincontext, my_session);
-- if retval is not 0, then raise exception
newDN := REPLACE(dn, 'DIT1', 'DIT2');
retval := DBMS_LDAP.delete_s(my_session, newDN);
-- if retval is not 0, then raise exception
rc := 0;
errmsg := 'no post_delete plug-in error msg';
EXCEPTION
WHEN others THEN
rc := 1;
errmsg := 'exception: post_delete plug-in';
END;
END LDAP_PLUGIN_EXAMPLE2;
/
(ldapplugincontext IN ODS.plugincontext,
result IN INTEGER,
dn IN VARCHAR2,
rc OUT INTEGER,
errmsg OUT VARCHAR2
)
IS
retval PLS_INTEGER;
my_session DBMS_LDAP.session;
newDN VARCHAR2(256);
BEGIN
retval := -1;
my_session := LDAP_PLUGIN.init(ldapplugincontext);
-- bind to the directory
retval := LDAP_PLUGIN.simple_bind_s(ldapplugincontext, my_session);
-- if retval is not 0, then raise exception
newDN := REPLACE(dn, 'DIT1', 'DIT2');
retval := DBMS_LDAP.delete_s(my_session, newDN);
-- if retval is not 0, then raise exception
rc := 0;
errmsg := 'no post_delete plug-in error msg';
EXCEPTION
WHEN others THEN

```

```

        rc := 1;
        errormsg := 'exception: post_delete plug-in';
    END;
END LDAP_PLUGIN_EXAMPLE2;
/

```

4. Register the plug-in entry with Oracle Internet Directory.

Construct the LDIF file `register_post_delete.ldif`:

```

dn: cn=post_delete,cn=plugin,cn=subconfigsentry
objectclass: orclPluginConfig
objectclass: top
orclPluginName: ldap_plugin_example2
orclPluginType: configuration
orclPluginTiming: post
orclPluginLDAPOperation: ldapdelete
orclPluginEnable: 1
orclPluginSubscriberDNList: cn=DIT1,cn=oraclecontext,cn=products
orclPluginVersion: 1.0.1
cn: post_delete
orclPluginKind: PLSQL

```

Use the `ldapadd` command-line tool to add this entry:

```

% ldapadd -p port_number -h host_name -D bind_dn -q -v -f register_
post_delete.ldif

```

Binary Support in the PL/SQLPlug-in Framework

Starting with release 10.1.2, object definitions in the Plug-in LDAP API enable `ldapmodify`, `ldapadd`, and `ldapcompare` plug-ins to access binary attributes in the directory database. Formerly, only attributes of type `VARCHAR2` could be accessed. These object definitions do not invalidate plug-in code that precedes release 10.1.2. No change to this code is required. The new definitions appear in the section "[Database Object Types Defined](#)".

The section that you are reading now examines binary operations involving the three types of plug-ins. It includes examples of these plug-ins. The new object definitions apply to pre, post, and when versions of all three.

Note that the three examples use RAW functions and variables in place of LOBs.

Binary Operations with `ldapmodify`

The `modobj` object that the plug-in framework passes to an `ldapmodify` plug-in now holds the values of binary attributes as `binvals`. This variable is a table of `binvalobj` objects.

The plug-in determines whether a binary operation is being performed by examining the `operation` field of `modobj`. It checks whether any of the values `DBMS_LDAP.MOD_ADD`, `DBMS_LDAP.MOD_DELETE`, and `DBMS_LDAP.MOD_REPLACE` are paired with `DBMS_LDAP.MOD_BVALUES`. The pairing `DBMS_LDAP.MOD_ADD+DBMS_LDAP.MOD_BVALUES`, for example, signifies a binary add in the modify operation.

The example that follows shows a post `ldapmodify` plug-in modifying an entry in another directory. The plug-in is invoked after `ldapmodify` applies the same change to the same entry in the plug-in directory. The entry in the other directory appears under the DIT `cn=users,dc=us,dc=example,dc=com`.

```

create or replace package moduser as

```

```

procedure post_modify(ldapplugincontext IN ODS.plugincontext,
                    result IN integer,
                    dn IN varchar2,
                    mods IN ODS.modlist,
                    rc OUT integer,
                    errormsg OUT varchar2);

end moduser;
/
show error

CREATE OR REPLACE PACKAGE BODY moduser AS
    procedure post_modify(ldapplugincontext IN ODS.plugincontext,
                        result IN integer,
                        dn IN varchar2,
                        mods IN ODS.modlist,
                        rc OUT integer,
                        errormsg OUT varchar2)

    is
        counter1 pls_integer;
        counter2 pls_integer;
        retval pls_integer := -1;
        user_session DBMS_LDAP.session;
        user_dn varchar(256);
        user_array DBMS_LDAP.mod_array;
        user_vals DBMS_LDAP.string_collection;
        user_binvals DBMS_LDAP.blob_collection;
        ldap_host varchar(256);
        ldap_port varchar(256);
        ldap_user varchar(256);
        ldap_passwd varchar(256);
    begin
        ldap_host := 'backup.us.example.com';
        ldap_port := '4000';
        ldap_user := 'cn=orcladmin';
        ldap_passwd := 'password';

        plg_debug('START MODIFYING THE ENTRY');

        -- Get a session
        user_session := dbms_ldap.init(ldap_host, ldap_port);

        -- Bind to the directory
        retval := dbms_ldap.simple_bind_s(user_session, ldap_user,
                                         ldap_passwd);

        -- Create a mod_array
        user_array := dbms_ldap.create_mod_array(mods.count);

        -- Create a user_dn
        user_dn := substr(dn,1,instr(dn,',',1,1)) || 'cn=users,dc=us,dc=example,
        dc=com';

        plg_debug('THE CREATED DN IS' || user_dn);

        -- Iterate through the modlist
        for counter1 in 1..mods.count loop

        -- Log the attribute name and operation
        if (mods(counter1).operation > DBMS_LDAP.MOD_BVALUES) then
            plg_debug('THE NAME OF THE BINARY ATTR. IS' || mods(counter1).type);

```

```
        else
            plg_debug('THE NAME OF THE NORMAL ATTR. IS' || mods(counter1).type);
        end if;
        plg_debug('THE OPERATION IS' || mods(counter1).operation);

-- Add the attribute values to the collection
for counter2 in 1..mods(counter1).vals.count loop
    user_vals(counter2) := mods(counter1).vals(counter2).val;
end loop;

-- Add the attribute values to the collection
for counter2 in 1..mods(counter1).binvals.count loop
    plg_debug('THE NO. OF BYTES OF THE BINARY ATTR. VALUE IS'
        || mods(counter1).binvals(counter2).length);
    user_binvals(counter2) := mods(counter1).binvals(counter2).binval;
end loop;

-- Populate the mod_array accordingly with binary/normal attributes
if (mods(counter1).operation >= DBMS_LDAP.MOD_BVALUES) then
    dbms_ldap.populate_mod_array(user_array,mods(counter1).operation -
        DBMS_LDAP.MOD_BVALUES,mods(counter1).type,user_binvals);
    user_binvals.delete;
else
    dbms_ldap.populate_mod_array(user_array,mods(counter1).operation,
        mods(counter1).type,user_vals);
    user_vals.delete;
end if;

end loop;

-- Modify the entry
retval := dbms_ldap.modify_s(user_session,user_dn,user_array);
if retval = 0 then
    rc := 0;
    errmsg:='No error occurred while modifying the entry';
else
    rc := retval;
    errmsg :='Error code' || rc || ' while modifying the entry';
end if;

-- Free the mod_array
dbms_ldap.free_mod_array(user_array);

plg_debug('FINISHED MODIFYING THE ENTRY');

exception
WHEN others THEN
    plg_debug (SQLERRM);
end;
end moduser;
/
show error

exit;
```

Binary Operations with ldapadd

The `entryobj` object that the plug-in framework passes to an `ldapadd` plug-in now holds binary attributes as `binattr`. This variable is a table of `binattrobj` objects. The example that follows shows a post-add plug-in propagating a change (an added

user) in the plug-in directory to another directory. In the latter directory, the entry appears under the DIT `cn=users,dc=us,dc=example,dc=com`.

```

create or replace package adduser as
  procedure post_add(ldapplugincontext IN ODS.plugincontext,
                    result IN integer,
                    dn IN varchar2,
                    entry IN ODS.entryobj,
                    rc OUT integer,
                    errormsg OUT varchar2);

end adduser;
/
show error

CREATE OR REPLACE PACKAGE BODY adduser AS
  procedure post_add(ldapplugincontext IN ODS.plugincontext,
                    result IN integer,
                    dn IN varchar2,
                    entry IN ODS.entryobj,
                    rc OUT integer,
                    errormsg OUT varchar2)
  is
    counter1 pls_integer;
    counter2 pls_integer;
    retval pls_integer := -1;
    s integer;
    user_session DBMS_LDAP.session;
    user_dn varchar(256);
    user_array DBMS_LDAP.mod_array;
    user_vals DBMS_LDAP.string_collection;
    user_binvals DBMS_LDAP.blob_collection;
    ldap_host varchar(256);
    ldap_port varchar(256);
    ldap_user varchar(256);
    ldap_passwd varchar(256);
  begin
    ldap_host := 'backup.us.example.com';
    ldap_port := '4000';
    ldap_user := 'cn=orcladmin';
    ldap_passwd := 'password';

    plg_debug('START ADDING THE ENTRY');

    -- Get a session
    user_session := dbms_ldap.init(ldap_host, ldap_port);

    -- Bind to the directory
    retval := dbms_ldap.simple_bind_s(user_session, ldap_user, ldap_passwd);

    -- Create a mod_array
    user_array := dbms_ldap.create_mod_array(entry.binattr.count +
      entry.attr.count);

    -- Create a user_dn
    user_dn := substr(dn,1,instr(dn,',',1,1))||'cn=users,dc=us,dc=example,
      dc=com';
    plg_debug('THE CREATED DN IS' || user_dn);

    -- Populate the mod_array with binary attributes
    for counter1 in 1..entry.binattr.count loop
      for counter2 in 1..entry.binattr(counter1).binattrval.count loop

```

```

        plg_debug('THE NAME OF THE BINARY ATTR. IS' ||
        entry.binattr(counter1).binattrname);
        s := dbms_lob.getlength(entry.binattr(counter1).
        binattrval(counter2));
        plg_debug('THE NO. OF BYTES OF THE BINARY ATTR. VALUE IS' ||s);
        user_binvals(counter2) := entry.binattr(counter1).
        binattrval(counter2);
    end loop;
    dbms_ldap.populate_mod_array(user_array,DBMS_LDAP.MOD_ADD,
    entry.binattr(counter1).binattrname,user_binvals);
    user_binvals.delete;
end loop;

-- Populate the mod_array with attributes
for counter1 in 1..entry.attr.count loop
    for counter2 in 1..entry.attr(counter1).attrval.count loop
        plg_debug('THE NORMAL ATTRIBUTE' ||entry.attr(counter1).attrname||'
        HAS THE VALUE' ||entry.attr(counter1).attrval(counter2));
        user_vals(counter2) := entry.attr(counter1).attrval(counter2);
    end loop;
    dbms_ldap.populate_mod_array(user_array,DBMS_LDAP.MOD_ADD,
    entry.attr(counter1).attrname,user_vals);
    user_vals.delete;
end loop;

-- Add the entry
retval := dbms_ldap.add_s(user_session,user_dn,user_array);
plg_debug('THE RETURN VALUE IS' ||retval);
if retval = 0 then
    rc := 0;
    errormsg:='No error occurred while adding the entry';
else
    rc := retval;
    errormsg :='Error code' ||rc||' while adding the entry';
end if;

-- Free the mod_array
dbms_ldap.free_mod_array(user_array);
retval := dbms_ldap.unbind_s(user_session);

plg_debug('FINISHED ADDING THE ENTRY');

exception
WHEN others THEN
    plg_debug (SQLERRM);
end;
end adduser;
/
show error

exit;

```

Binary Operations with Ildapcompare

The `ldapcompare` plug-in can use three new overloaded module interfaces to compare binary attributes. If you want to use these interfaces to develop a plug-in package that handles both binary and nonbinary attributes, you must include two separate procedures in the package. The package name for both procedures is the same because only one `orclPluginName` can be registered in the plug-in entry.

After updating an existing plug-in package to include a procedure that compares binary attributes, reinstall the package. Recompile packages that depend on the plug-in package.

The three new interfaces look like this:

```
PROCEDURE pre_compare (ldapplugincontext IN ODS.plugincontext,
                      dn                 IN VARCHAR2,
                      attrname           IN VARCHAR2,
                      attrval            IN BLOB,
                      rc                  OUT INTEGER,
                      errmsg              OUT VARCHAR2 );

PROCEDURE when_compare_replace (ldapplugincontext IN ODS.plugincontext,
                                result            OUT INTEGER,
                                dn                 IN VARCHAR2,
                                attrname           IN VARCHAR2,
                                attrval            IN BLOB,
                                rc                  OUT INTEGER,
                                errmsg              OUT VARCHAR2 );

PROCEDURE post_compare (ldapplugincontext IN ODS.plugincontext,
                        result            IN INTEGER,
                        dn                 IN VARCHAR2,
                        attrname           IN VARCHAR2,
                        attrval            IN BLOB,
                        rc                  OUT INTEGER,
                        errmsg              OUT VARCHAR2 );
```

The example that follows compares a binary attribute of an entry in the plug-in directory with a binary attribute of an entry in another directory. This package replaces the compare code of the server with the compare code of the plug-in. The package handles both binary and nonbinary attributes. As such it contains two separate procedures.

```
create or replace package compareattr as
  procedure when_compare_replace(ldapplugincontext IN ODS.plugincontext,
                                result OUT integer,
                                dn IN varchar2,
                                attrname IN VARCHAR2,
                                attrval IN BLOB,
                                rc OUT integer,
                                errmsg OUT varchar2);
  procedure when_compare_replace(ldapplugincontext IN ODS.plugincontext,
                                result OUT integer,
                                dn IN varchar2,
                                attrname IN VARCHAR2,
                                attrval IN varchar2,
                                rc OUT integer,
                                errmsg OUT varchar2);
end compareattr;
/
show error

CREATE OR REPLACE PACKAGE BODY compareattr AS
  procedure when_compare_replace(ldapplugincontext IN ODS.plugincontext,
                                result OUT integer,
                                dn IN varchar2,
                                attrname IN VARCHAR2,
                                attrval IN varchar2,
                                rc OUT integer,
```

```

                                errormsg OUT varchar2)
is
pos                                INTEGER := 2147483647;
begin
    plg_debug('START');
    plg_debug('THE ATTRNAME IS' || attrname || ' AND THE VALUE IS' || attrval);
    plg_debug('END');
    rc := 0;
    errormsg := 'No error!!!';
exception
WHEN others THEN
    plg_debug ('Unknown UTL_FILE Error');
end;

procedure when_compare_replace(ldapplugincontext IN ODS.plugincontext,
                                result OUT integer,
                                dn IN varchar2,
                                attrname IN VARCHAR2,
                                attrval IN BLOB,
                                rc OUT integer,
                                errormsg OUT varchar2)
is
    counter pls_integer;
    retval pls_integer := -1;
    cmp_result integer;
    s integer;
    user_session DBMS_LDAP.session;
    user_entry DBMS_LDAP.message;
    user_message DBMS_LDAP.message;
    user_dn varchar(256);
    user_attrs DBMS_LDAP.string_collection;
    user_attr_name VARCHAR2(256);
    user_ber_elmt DBMS_LDAP.ber_element;
    user_vals DBMS_LDAP.blob_collection;
    ldap_host varchar(256);
    ldap_port varchar(256);
    ldap_user varchar(256);
    ldap_passwd varchar(256);
    ldap_base varchar(256);
begin
    ldap_host := 'backup.us.example.com';
    ldap_port := '4000';
    ldap_user := 'cn=orcladmin';
    ldap_passwd := 'password';
    ldap_base := dn;

    plg_debug('STARTING COMPARISON IN WHEN REPLACE PLUG-IN');

    s := dbms_lob.getlength(attrval);
    plg_debug('THE NUMBER OF BYTES OF ATTRVAL' || s);

    -- Get a session
    user_session := dbms_ldap.init(ldap_host, ldap_port);

    -- Bind to the directory
    retval := dbms_ldap.simple_bind_s(user_session, ldap_user, ldap_passwd);

    -- issue the search
    user_attrs(1) := attrname;
    retval := DBMS_LDAP.search_s(user_session, ldap_base,

```

```

        DBMS_LDAP.SCOPE_BASE,
        'objectclass=*',
        user_attrs,
        0,
        user_message);

-- Get the entry in the other OID server
user_entry := DBMS_LDAP.first_entry(user_session, user_message);

-- Log the DN and the Attribute name
user_dn := DBMS_LDAP.get_dn(user_session, user_entry);
plg_debug('THE DN IS' || user_dn);
user_attr_name := DBMS_LDAP.first_attribute(user_session, user_entry,
user_ber_elmt);

-- Get the values of the attribute
user_vals := DBMS_LDAP.get_values_blob(user_session, user_entry,
user_attr_name);

-- Start the binary comparison between the ATTRVAL and the attribute
-- values
if user_vals.count > 0 then
  for counter in user_vals.first..user_vals.last loop
    cmp_result := dbms_lob.compare(user_vals(counter), attrval,
      dbms_lob.getlength(user_vals(counter)), 1, 1);
    if cmp_result = 0 then
      rc := 0;
      -- Return LDAP_COMPARE_TRUE
      result := 6;
      plg_debug('THE LENGTH OF THE ATTR.' || user_attr_name || ' IN THE
        ENTRY IS' || dbms_lob.getlength(user_vals(counter)));
      errormsg := 'NO ERROR. THE COMPARISON HAS SUCCEEDED.';
      plg_debug(errormsg);
      plg_debug('FINISHED COMPARISON');
      return;
    end if;
  end loop;
end if;

rc := 1;
-- Return LDAP_COMPARE_FALSE
result := 5;
errormsg := 'ERROR. THE COMPARISON HAS FAILED.';
plg_debug('THE LENGTH OF THE ATTR.' || user_attr_name || ' IN THE ENTRY IS'
  || dbms_lob.getlength(user_vals(user_vals.last)));
plg_debug(errormsg);
plg_debug('FINISHED COMPARISON');

-- Free user_vals
dbms_ldap.value_free_blob(user_vals);
exception
  WHEN others THEN
    plg_debug (SQLERRM);
end;
end compareattr;
/
show error

exit;

```

Database Object Types Defined

This section defines the object types introduced in the Plug-in LDAP API. All of these definitions are in Oracle Directory Server database schema. Note that the API includes object types that enable plug-ins to extract binary data from the database.

```
create or replace type strCollection as TABLE of VARCHAR2(512);
/
create or replace type pluginContext as TABLE of VARCHAR2(512);
/
create or replace type attrvalType as TABLE OF VARCHAR2(4000);
/
create or replace type attrobj as object (
  attrname  varchar2(2000),
  attrval   attrvalType
);
/
create or replace type attrlist as table of attrobj;
/
create or replace type binattrvalType as TABLE OF BLOB;
/
create or replace type binattrobj as object (
  binattrname  varchar2(2000),
  binattrval   binattrvalType
);
/
create or replace type binattrlist as table of binattrobj;
/
create or replace type entryobj as object (
  entryname  varchar2(2000),
  attr       attrlist,
  binattr    binattrlist
);
/
create or replace type entrylist as table of entryobj;
/

create or replace type bvalobj as object (
  length     integer,
  val        varchar2(4000)
);
/
create or replace type bvallist as table of bvalobj;
/
create or replace type binvalobj as object (
  length     integer,
  binval     blob
);
/
create or replace type binvallist as table of binvalobj;
/
create or replace type modobj as object (
  operation  integer,
  type       varchar2(256),
  vals       bvallist,
  binvals    binvallist
);
/
create or replace type modlist as table of modobj;
```

Specifications for PL/SQL Plug-in Procedures

When you use the plug-ins, you must adhere to the signature defined for each of them. Each signature is provided here.

```
PROCEDURE pre_add (ldapplugincontext IN ODS.plugincontext,
  dn          IN VARCHAR2,
  entry       IN ODS.entryobj,
  rc          OUT INTEGER,
  errormsg    OUT VARCHAR2);
```

```
PROCEDURE when_add (ldapplugincontext IN ODS.plugincontext,
  dn          IN VARCHAR2,
  entry       IN ODS.entryobj,
  rc          OUT INTEGER,
  errormsg    OUT VARCHAR2);
```

```
PROCEDURE when_add_replace (ldapplugincontext IN ODS.plugincontext,
  dn          IN VARCHAR2,
  entry       IN ODS.entryobj,
  rc          OUT INTEGER,
  errormsg    OUT VARCHAR2);
```

```
PROCEDURE post_add (ldapplugincontext IN ODS.plugincontext,
  result      IN INTEGER,
  dn          IN VARCHAR2,
  entry       IN ODS.entryobj,
  rc          OUT INTEGER,
  errormsg    OUT VARCHAR2);
```

```
PROCEDURE pre_modify (ldapplugincontext IN ODS.plugincontext,
  dn          IN VARCHAR2,
  mods        IN ODS.modlist,
  rc          OUT INTEGER,
  errormsg    OUT VARCHAR2);
```

```
PROCEDURE when_modify (ldapplugincontext IN ODS.plugincontext,
  dn          IN VARCHAR2,
  mods        IN ODS.modlist,
  rc          OUT INTEGER,
  errormsg    OUT VARCHAR2);
```

```
PROCEDURE when_modify_replace (ldapplugincontext IN ODS.plugincontext,
  dn          IN VARCHAR2,
  mods        IN ODS.modlist,
  rc          OUT INTEGER,
  errormsg    OUT VARCHAR2);
```

```
PROCEDURE post_modify (ldapplugincontext IN ODS.plugincontext,
  result      IN INTEGER,
  dn          IN VARCHAR2,
  mods        IN ODS.modlist,
  rc          OUT INTEGER,
  errormsg    OUT VARCHAR2);
```

```
PROCEDURE pre_compare (ldapplugincontext IN ODS.plugincontext,
dn                IN VARCHAR2,
attrname         IN VARCHAR2,
attrval         IN VARCHAR2,
rc              OUT INTEGER,
errormsg        OUT VARCHAR2
);

PROCEDURE pre_compare (ldapplugincontext IN ODS.plugincontext,
dn                IN VARCHAR2,
attrname         IN VARCHAR2,
attrval         IN BLOB,
rc              OUT INTEGER,
errormsg        OUT VARCHAR2 );

PROCEDURE when_compare_replace (ldapplugincontext IN ODS.plugincontext,
result          OUT INTEGER,
dn             IN VARCHAR2,
attrname       IN VARCHAR2,
attrval       IN VARCHAR2,
rc            OUT INTEGER,
errormsg      OUT VARCHAR2
);

PROCEDURE when_compare_replace (ldapplugincontext IN ODS.plugincontext,
result          OUT INTEGER,
dn             IN VARCHAR2,
attrname       IN VARCHAR2,
attrval       IN BLOB,
rc            OUT INTEGER,
errormsg      OUT VARCHAR2 );

PROCEDURE post_compare (ldapplugincontext IN ODS.plugincontext,
result          IN INTEGER,
dn             IN VARCHAR2,
attrname       IN VARCHAR2,
attrval       IN VARCHAR2,
rc            OUT INTEGER,
errormsg      OUT VARCHAR2
);

PROCEDURE post_compare (ldapplugincontext IN ODS.plugincontext,
result          IN INTEGER,
dn             IN VARCHAR2,
attrname       IN VARCHAR2,
attrval       IN BLOB,
rc            OUT INTEGER,
errormsg      OUT VARCHAR2 );

PROCEDURE pre_delete (ldapplugincontext IN ODS.plugincontext,
dn             IN VARCHAR2,
rc            OUT INTEGER,
errormsg      OUT VARCHAR2
);

PROCEDURE when_delete (ldapplugincontext IN ODS.plugincontext,
dn             IN VARCHAR2,
rc            OUT INTEGER,
errormsg      OUT VARCHAR2
```



```
);
PROCEDURE when_delete_replace (ldapplugincontext IN ODS.plugincontext,
dn          IN VARCHAR2,
rc          OUT INTEGER,
errormsg   OUT VARCHAR2
);

PROCEDURE post_delete (ldapplugincontext IN ODS.plugincontext,
result      IN INTEGER,
dn          IN VARCHAR2,
rc          OUT INTEGER,
errormsg   OUT VARCHAR2
);

PROCEDURE pre_search (ldapplugincontext IN ODS.plugincontext,
basedn      IN VARCHAR2,
scope      IN INTEGER,
filterStr  IN VARCHAR2,
requiredAttr IN ODS.strCollection,
rc         OUT INTEGER,
errormsg   OUT VARCHAR2
);

PROCEDURE post_search (ldapplugincontext IN ODS.plugincontext,
result      IN INTEGER,
basedn      IN VARCHAR2,
scope      IN INTEGER,
filterStr  IN VARCHAR2,
requiredAttr IN ODS.strCollection,
rc         OUT INTEGER,
errormsg   OUT VARCHAR2
);

PROCEDURE pre_bind (ldapplugincontext IN ODS.plugincontext,
dn          IN VARCHAR2,
passwd     IN VARCHAR2,
rc         OUT INTEGER,
errormsg   OUT VARCHAR2
);

PROCEDURE when_bind_replace (ldapplugincontext IN ODS.plugincontext,
result     OUT INTEGER,
dn        IN VARCHAR2,
passwd    IN VARCHAR2,
rc        OUT INTEGER,
errormsg  OUT VARCHAR2
);

PROCEDURE post_bind (ldapplugincontext IN ODS.plugincontext,
result     IN INTEGER,
dn        IN VARCHAR2,
passwd    IN VARCHAR2,
rc        OUT INTEGER,
errormsg  OUT VARCHAR2
);
```

The LDAP Filter Definition

The paper contained in this appendix is copied with permission from RFC 2254 of the Internet Engineering Task Force. This document is located at:

<http://www.ietf.org>

The contents of this paper may have been superseded by later papers or other information. Check the above Web site and related sites for additional or supplementary information.

NOTE: ORACLE DISCLAIMS ALL WARRANTIES, EXPRESSED OR IMPLIED, INCLUDING BUT NOT LIMITED TO ANY WARRANTY THAT THE USE OF THE INFORMATION HEREIN WILL NOT INFRINGE ANY RIGHTS OR ANY IMPLIED WARRANTIES OF MERCHANTABILITY OR FITNESS FOR A PARTICULAR PURPOSE.

Network Working Group
Request for Comments: 2254
Category: Standards Track

T. Howes
Netscape Communications Corp.
December 1997

The String Representation of LDAP Search Filters

1. Status of this Memo

This document specifies an Internet standards track protocol for the Internet community, and requests discussion and suggestions for improvements. Please refer to the current edition of the "Internet Official Protocol Standards" (STD 1) for the standardization state and status of this protocol. Distribution of this memo is unlimited.

Copyright Notice

Copyright (C) The Internet Society (1997). All Rights Reserved.

IESG Note

This document describes a directory access protocol that provides both read and update access. Update access requires secure authentication, but this document does not mandate implementation of any satisfactory authentication mechanisms.

In accordance with RFC 2026, section 4.4.1, this specification is being approved by IESG as a Proposed Standard despite this limitation, for the following reasons:

- a. to encourage implementation and interoperability testing of these protocols (with or without update access) before they are deployed, and

b. to encourage deployment and use of these protocols in read-only applications. (e.g. applications where LDAPv3 is used as a query language for directories which are updated by some secure mechanism other than LDAP), and

c. to avoid delaying the advancement and deployment of other Internet standards-track protocols which require the ability to query, but not update, LDAPv3 directory servers.

Readers are hereby warned that until mandatory authentication mechanisms are standardized, clients and servers written according to this specification which make use of update functionality are UNLIKELY TO INTEROPERATE, or MAY INTEROPERATE ONLY IF AUTHENTICATION IS REDUCED TO AN UNACCEPTABLY WEAK LEVEL.

Implementors are hereby discouraged from deploying LDAPv3 clients or servers which implement the update functionality, until a Proposed Standard for mandatory authentication in LDAPv3 has been approved and published as an RFC.

2. Abstract

The Lightweight Directory Access Protocol (LDAP) [1] defines a network representation of a search filter transmitted to an LDAP server. Some applications may find it useful to have a common way of representing these search filters in a human-readable form. This document defines a human-readable string format for representing LDAP search filters.

This document replaces RFC 1960, extending the string LDAP filter definition to include support for LDAP version 3 extended match filters, and including support for representing the full range of possible LDAP search filters.

3. LDAP Search Filter Definition

An LDAPv3 search filter is defined in Section 4.5.1 of [1] as follows:

```
Filter ::= CHOICE {
    and          [0] SET OF Filter,
    or           [1] SET OF Filter,
    not          [2] Filter,
    equalityMatch [3] AttributeValueAssertion,
    substrings   [4] SubstringFilter,
    greaterOrEqual [5] AttributeValueAssertion,
    lessOrEqual  [6] AttributeValueAssertion,
    present      [7] AttributeDescription,
    approxMatch  [8] AttributeValueAssertion,
    extensibleMatch [9] MatchingRuleAssertion
}
SubstringFilter ::= SEQUENCE {
    type AttributeDescription,
    SEQUENCE OF CHOICE {
        initial [0] LDAPString,
```

```

        any      [1] LDAPString,
        final    [2] LDAPString
    }
}
AttributeValueAssertion ::= SEQUENCE {
    attributeDesc  AttributeDescription,
    attributeValue AttributeValue
}
MatchingRuleAssertion ::= SEQUENCE {
    matchingRule  [1] MatchingRuleID OPTIONAL,
    type          [2] AttributeDescription OPTIONAL,
    matchValue    [3] AssertionValue,
    dnAttributes  [4] BOOLEAN DEFAULT FALSE
}
AttributeDescription ::= LDAPString
AttributeValue ::= OCTET STRING
MatchingRuleID ::= LDAPString
AssertionValue ::= OCTET STRING
LDAPString ::= OCTET STRING

```

where the LDAPString above is limited to the UTF-8 encoding of the ISO 10646 character set [4]. The AttributeDescription is a string representation of the attribute description and is defined in [1].

The AttributeValue and AssertionValue OCTET STRING have the form defined in [2]. The Filter is encoded for transmission over a network using the Basic Encoding Rules defined in [3], with simplifications described in [1].

4. String Search Filter Definition

The string representation of an LDAP search filter is defined by the following grammar, following the ABNF notation defined in [5]. The filter format uses a prefix notation.

```

filter    = "(" filtercomp ")"
filtercomp = and / or / not / item
and       = "&" filterlist
or        = "|" filterlist
not       = "!" filter
filterlist = 1*filter
item      = simple / present / substring / extensible
simple     = attr filtertype value
filtertype = equal / approx / greater / less
equal     = "="

```

```

approx  = "~="
greater = ">="
less    = "<="
extensible = attr [":dn"] [":" matchingrule] "!=" value
          / [":dn"] ":" matchingrule "!=" value
present  = attr "*"
substring = attr "=" [initial] any [final]
initial  = value
any      = "*" *(value "*")
final    = value
attr     = AttributeDescription from Section 4.1.5 of [1]
matchingrule = MatchingRuleId from Section 4.1.9 of [1]
value    = AttributeValue from Section 4.1.6 of [1]

```

The attr, matchingrule, and value constructs are as described in the corresponding section of [1] given above.

If a value should contain any of the following characters

Character	ASCII value
*	0x2a
(0x28
)	0x29
\	0x5c
NUL	0x00

then the character must be encoded as the backslash '\ ' character (ASCII 0x5c) followed by the two hexadecimal digits representing the ASCII value of the encoded character. The case of the two hexadecimal digits is not significant.

This simple escaping mechanism eliminates filter-parsing ambiguities and allows any filter that can be represented in LDAP to be represented as a NUL-terminated string. Other characters besides the ones listed above may be escaped using this mechanism, for example, non-printing characters.

For example, the filter checking whether the "cn" attribute contained a value with the character "*" anywhere in it would be represented as

```
"(cn=*\2a*)".
```

Note that although both the substring and present productions in the grammar above can produce the "attr="*" construct, this construct is used only to denote a presence filter.

5. Examples

This section gives a few examples of search filters written using this notation.

```
(cn=Babs Jensen)
```

```
(!(cn=Tim Howes))
```

```
(&(objectClass=Person)(!(sn=Jensen)(cn=Babs J*)))  
(o=univ*of*mich*)
```

The following examples illustrate the use of extensible matching.

```
(cn:1.2.3.4.5:=Fred Flintstone)  
(sn:dn:2.4.6.8.10:=Barney Rubble)  
(o:dn:=Ace Industry)  
(:dn:2.4.6.8.10:=Dino)
```

The second example illustrates the use of the ":dn" notation to indicate that matching rule "2.4.6.8.10" should be used when making comparisons, and that the attributes of an entry's distinguished name should be considered part of the entry when evaluating the match.

The third example denotes an equality match, except that DN components should be considered part of the entry when doing the match.

The fourth example is a filter that should be applied to any attribute supporting the matching rule given (since the attr has been left off). Attributes supporting the matching rule contained in the DN should also be considered.

The following examples illustrate the use of the escaping mechanism.

```
(o=Parens R Us \28for all your parenthetical needs\29)  
(cn=*\2A*)  
(filename=C:\5cMyFile)  
(bin=\00\00\00\04)  
(sn=Lu\c4\8di\c4\87)
```

The first example shows the use of the escaping mechanism to represent parenthesis characters. The second shows how to represent a "*" in a value, preventing it from being interpreted as a substring indicator. The third illustrates the escaping of the backslash character.

The fourth example shows a filter searching for the four-byte value 0x00000004, illustrating the use of the escaping mechanism to represent arbitrary data, including NUL characters.

The final example illustrates the use of the escaping mechanism to represent various non-ASCII UTF-8 characters.

6. Security Considerations

This memo describes a string representation of LDAP search filters. While the representation itself has no known security implications, LDAP search filters do. They are interpreted by LDAP servers to select entries from which data is retrieved. LDAP servers should take care to protect the data they maintain from unauthorized access.

7. References

- [1] Wahl, M., Howes, T., and S. Kille, "Lightweight Directory Access Protocol (v3)", RFC 2251, December 1997.
- [2] Wahl, M., Coulbeck, A., Howes, T., and S. Kille, "Lightweight Directory Access Protocol (v3): Attribute Syntax Definitions", RFC 2252, December 1997.

-
- [3] Specification of ASN.1 encoding rules: Basic, Canonical, and Distinguished Encoding Rules, ITU-T Recommendation X.690, 1994.
- [4] Yergeau, F., "UTF-8, a transformation format of Unicode and ISO 10646", RFC 2044, October 1996.
- [5] Crocker, D., "Standard for the Format of ARPA Internet Text Messages", STD 11, RFC 822, August 1982.

8. Author's Address

Tim Howes
Netscape Communications Corp.
501 E. Middlefield Road
Mountain View, CA 94043
USA
Phone: +1 415 937-3419
EMail: howes@netscape.com

9. Full Copyright Statement

Copyright (C) The Internet Society (1997). All Rights Reserved.

This document and translations of it may be copied and furnished to others, and derivative works that comment on or otherwise explain it or assist in its implementation may be prepared, copied, published and distributed, in whole or in part, without restriction of any kind, provided that the above copyright notice and this paragraph are included on all such copies and derivative works. However, this document itself may not be modified in any way, such as by removing the copyright notice or references to the Internet Society or other

Internet organizations, except as needed for the purpose of developing Internet standards in which case the procedures for copyrights defined in the Internet Standards process must be followed, or as required to translate it into languages other than English.

The limited permissions granted above are perpetual and will not be revoked by the Internet Society or its successors or assigns.

This document and the information contained herein is provided on an "AS IS" basis and THE INTERNET SOCIETY AND THE INTERNET ENGINEERING TASK FORCE DISCLAIMS ALL WARRANTIES, EXPRESS OR IMPLIED, INCLUDING BUT NOT LIMITED TO ANY WARRANTY THAT THE USE OF THE INFORMATION HEREIN WILL NOT INFRINGE ANY RIGHTS OR ANY IMPLIED WARRANTIES OF MERCHANTABILITY OR FITNESS FOR A PARTICULAR PURPOSE.

The Access Control Directive Format

This appendix describes the format (syntax) of any access control item (ACI). It contains these topics:

- [Schema for orclACI](#)
- [Schema for orclEntryLevelACI](#)

Schema for orclACI

The access control directive defined by the user attribute `orclACI` has the following schema:

```
OrclACI:{ object_identifier NAME 'orclACI' DESC 'Stores an inheritable ACI'
EQUALITY
accessDirectiveMatch SYNTAX 'accessDirectiveDescription' USAGE
'directoryOperation'}
```

`accessDirectiveDescription` has the following BNF:

```
<accessDirectiveDescription>
    ::= access to <object> [by <subject> ( <accessList> )]+

<object> ::= [attr <EQ-OR-NEQ> ( * | (<attrList> ) ) | entry]
[filter=(<ldapFilter>)] [DenyGroupOverride] [AppendToAll]

<subject> ::= <entity> [<BindMode>] [<BindIPFilter>] [Added_object_
constraint=(<ldapFilter>)]
<entity> ::= * | self | dn="<regex>" | dnAttr=(<dn_attribute>) | group="<dn>" |
guidattr=(<guid_attribute>) | groupattr=(<group_attribute>) | [SuperUser]

BindMode=(LDAP_authentication_choice) | LDAP_security_choice
LDAP_authentication_choice::= proxy | simple | MD5Digest | PKCS12
LDAP_security_choice::= SSLNoAuth | SSLOneWay | SASL

BindIPFilter=(<ldapFilter for orclipaddress>)
ex: (|(orclipaddress=1.2.3.*)|(orclipaddress=1.2.4.*)),
(&(orclipaddress!=1.2.*)|(orclipaddress!=3.4.*))

<accessList> ::= <access> | <access>, <accessList>

<access> ::= none | compare | search | browse | proxy | read | selfwrite | write |
add | delete | nocompare | nosearch | nobrowse | noproxy | noread | noselfwrite |
nowrite | noadd | nodelete

<attrList> ::= <attribute name> | <attribute name>,<attrList>

<EQ-OR-NEQ> ::= = | !=
```

```
<regex> ::= <dn> | *,<dn_of_any_subtree_root>
```

Note: The regular expression defined earlier is not meant to match any arbitrary expression. The syntax only allows expressions where the wildcard is followed by a comma and a valid DN. The latter DN denoted by *<dn_of_any_subtree_root>* is intended to specify the root of some subtree.

Schema for orclEntryLevelACI

The BER format for orclEntryLevelACI is the same as the format for orclACI.

The entry level access control directive defined by the user attribute orclEntryLevelACI has the following schema:

```
"orclEntryLevelACI":
{ object_identifier NAME 'orclEntryLevelACI' DESC 'Stores entry level ACL
Directive'
EQUALITY accessDirectiveMatch SYNTAX 'orclEntryLevelACIDescription'
USAGE 'directoryOperation' }
```

```
<orclEntryLevelACIDescription>
::= access to <object> [by <subject> ( <accessList> )]+
```

Globalization Support in the Directory

Oracle Internet Directory uses Globalization Support to store, process and retrieve data in native languages. It ensures that Oracle Internet Directory utilities and error messages automatically adapt to the native language and locale.

This chapter discusses Globalization Support as used by Oracle Internet Directory and tells you the required `NLS_LANG` environment variables for the various components and tools in an Oracle Internet Directory environment.

See Also: ["Globalization Support"](#) on page 3-15 before configuring Globalization Support

This chapter contains these topics:

- [About Character Sets and the Directory](#)
- [The NLS_LANG Environment Variable](#)
- [Using Non-AL32UTF8 Databases](#)
- [Using Globalization Support with LDIF Files](#)
- [Using Globalization Support with Command-Line LDAP Tools](#)
- [Setting NLS_LANG in the Client Environment](#)
- [Using Globalization Support with Bulk Tools](#)

About Character Sets and the Directory

When computer systems process characters, they use numeric codes instead of the graphical representation of the character. For example, when the database stores the letter A, it actually stores a numeric code that is interpreted by software as the letter.

A group of characters (for example, alphabetic characters, ideographs, symbols, punctuation marks, and control characters) can be encoded as a character set. Each encoded character set assigns a unique code to each character in the set. For example, in the ASCII encoding scheme, the character code of the first character of the English upper-case alphabet is 0x41; in the EBCDIC encoding scheme, it is 0xc1.

The computer industry uses many encoded character sets. These character sets can differ in the number and types of characters available and in many other ways as well.

When you create a database, you specify an encoded character set. Choosing a character set determines, among other things, what languages can be represented in the database.

Oracle supports most national, international, and vendor-specific encoded character set standards.

This section contains the following topics:

- [About Unicode](#)
- [About Oracle and UTF-8](#)
- [Migration from UTF8 to AL32UTF8 when Upgrading Oracle Internet Directory](#)

About Unicode

No single character set contains enough characters to meet the requirements of day-to-day e-business requirements. For example, no one national character set can represent all the languages in the European Union. Moreover, there are potential conflicts between character sets because the same character can be represented by different codes in different character sets.

To overcome these obstacles, a global character set, called Unicode, was developed. It is a universal encoded character set that can store information from any language including punctuation marks, diacritics, mathematical symbols, technical symbols, musical symbols, and so forth. As of version 3.2, the Unicode Standard supports over 95,000 characters from the world's alphabets, ideograph sets, and symbol collections. It includes 45,000 supplementary characters, most of which are Chinese, Japanese, and Korean characters that are rarely used but nevertheless need representation in electronic documentation.

Unicode has more than one implementation standard, and these are described in [Table I-1](#).

Table I-1 Unicode Implementations

Implementation	Description
UTF-8	A variable-width 8-bit encoding of Unicode. One Unicode character can be one, two, three, or four bytes. Characters from European scripts are represented in one or two bytes. Those from Asian scripts are represented in three bytes, and supplementary characters are represented in four.
UCS-2	A fixed-width 16-bit encoding of Unicode in which each character, regardless of the script, is two bytes.
UTF-16	The 16-bit encoding of Unicode. It is an extension of UCS-2 that supports the supplementary characters added in Unicode 3.1. One character can be two or four bytes. Characters from European and Asian scripts are represented in two bytes, and supplementary characters are represented in four.

About Oracle and UTF-8

Oracle began supporting Unicode as a database character set beginning with Oracle database version 7. With Oracle9i, Oracle added a new UTF-8 character set called AL32UTF8. This database character set supports the latest version of Unicode (3.2), including the latest supplementary characters. Oracle intends to enhance AL32UTF8 as necessary to support future versions of the Unicode standard.

Migration from UTF8 to AL32UTF8 when Upgrading Oracle Internet Directory

Oracle Internet Directory now supports AL32UTF8. If you have upgraded Oracle Internet Directory from a version before 10g (10.1.4.0.1), then, for better performance,

Oracle recommends that you change the character set for the directory database from UTF8 to AL32UTF8. To do this:

1. Run the character set scanner (CSSCAN) to ensure that there are no invalid UTF8 characters inside your current database.
2. Run the CSALTER script to update the database to AL32UTF8.

See Also: The chapter on character set migration in the *Oracle Database Globalization Support Guide* in the Oracle Database Documentation Library

The NLS_LANG Environment Variable

The NLS_LANG parameter has three components—language, territory, and charset—in the form:

```
NLS_LANG = language_territory.charset
```

Each component controls the operation of a subset of Globalization Support features.

Components of the NLS_LANG parameter are shown in [Table I-2](#).

Table I-2 Components of the NLS_LANG Parameter

Component	Description
language	<p>Specifies conventions such as the language used for Oracle messages, day names, and month names. Each supported language has a unique name—for example, American English, French, or German.</p> <p>If language is not specified, the value defaults to American English.</p> <p>See Also: <i>Oracle Database Globalization Support Guide</i> in the Oracle Database Documentation Library for a complete list of languages</p>
territory	<p>Specifies conventions such as the default calendar, collation, date, monetary, and numeric formats. Each supported territory has a unique name; for example, America, France, or Canada.</p> <p>If territory is not specified, the value defaults to America.</p> <p>See Also: <i>Oracle Database Globalization Support Guide</i> in the Oracle Database Documentation Library for a complete list of territories</p>
charset	<p>Specifies the character set used by the client application (normally that of the user's terminal). Each supported character set has a unique acronym, for example, WE8MSWIN1252, JA16SJIS, or AL32UTF8.</p> <p>See Also: <i>Oracle Database Globalization Support Guide</i> in the Oracle Database Documentation Library for a complete list of character sets</p>

You can set NLS_LANG as an environment variable at the command line. The following are examples of legal values for NLS_LANG:

- AMERICAN_AMERICA.AL32UTF8
- JAPANESE_JAPAN.AL32UTF8

Using Non-AL32UTF8 Databases

You can run the Oracle directory server and database tools on a non-AL32UTF8 database, but be sure that all characters in the client character set are included in the database character set (with the same or different codes). Otherwise, you can lose data during `ldapadd`, `ldapdelete`, `ldapmodify`, or `ldapmodifydn` operations. For example, suppose that you perform an `ldapadd` operation using a multibyte character set on an underlying database that uses only single-byte characters. You will lose data because not all of the bytes you enter are accepted by the database.

Using Globalization Support with LDIF Files

See Also: "LDIF file formatting rules and examples" in *Oracle Fusion Middleware Reference for Oracle Identity Management*

Attribute type names are always ASCII strings that cannot contain multibyte characters. Oracle Internet Directory does not support multibyte characters in attribute type names. However, Oracle Internet Directory does support attribute *values* containing multibyte characters such as those in the simplified Chinese (ZHS16GBK) character set.

Attribute values can be encoded in different ways to allow Oracle Internet Directory tools to interpret them properly. There are two scenarios:

- [An LDIF file Containing Only ASCII Strings](#)
- [An LDIF file Containing UTF-8 Encoded Strings](#)

An LDIF file Containing Only ASCII Strings

In this scenario, character strings for attribute values are also in ASCII.

Because all tools use the UTF-8 character set by default, and ASCII is a proper subset of UTF-8, all tools can interpret these files. The same is true of keyboard input of values that are simply ASCII strings.

An LDIF file Containing UTF-8 Encoded Strings

In this scenario, character strings for attribute values are also in UTF-8.

Because, by default, all tools use the UTF-8 character set, all tools can interpret these files. The same is true of keyboard input of values that are UTF-8 strings.

In such a file, some characters may be multibyte. Multibyte characters strings can be present in the LDIF files as attribute values or given as keyboard input. They can be encoded in their native character set or in UTF-8. They can also be BASE64 encoded representations of either the native or the UTF-8 string.

Consider the following cases:

- [CASE 1: Native Strings \(Non-UTF-8\)](#)
- [CASE 2: UTF-8 Strings](#)
- [CASE 3: BASE64 Encoded UTF-8 Strings](#)
- [CASE 4: BASE64 Encoded Native Strings](#)

Because the directory server understands and expects only UTF-8 encoded strings, cases 1, 3, and 4 need to undergo conversion to UTF-8 strings before they can be sent to the LDAP server.

CASE 1: Native Strings (Non-UTF-8)

If `NLS_LANG` is not set, use the `-E character_set` argument with the command-line LDAP tools `ldapadd`, `ldapaddmt`, `ldapbind`, `ldapcompare`, `ldapmoddn`, `ldapmod`, `ldapdelete`, and `ldapsearch`. You do not need to use the `-E character_set` argument if `NLS_LANG` is set.

This example converts simplified Chinese native strings to UTF-8. The baseDN can be a simplified Chinese string:

```
ldapsearch -h my_host -D "cn=orcladmin" -q -p 3060 -E ".ZHS16GBK" -b base_DN \
-s base "objectclass=*
```

Use the `encode="character_set"` argument with the command-line bulk tools `bulkload`, `bulkmodify`, `bulkdelete`, and `ldifwrite`, where `character_set` is the character set used in the LDIF file. Set `NLS_LANG` to the character set used by the directory's database.

CASE 2: UTF-8 Strings

No conversion is required.

CASE 3: BASE64 Encoded UTF-8 Strings

You do not need to use the `-E character_set` argument with the LDAP tools, even if `NLS_LANG` is not set.

You do not need to use the `encode=character_set` argument with the command-line tools. Oracle Internet Directory tools automatically decode BASE64 encoded UTF-8 strings to UTF-8 strings.

CASE 4: BASE64 Encoded Native Strings

If `NLS_LANG` is not set, use the `-E character_set` argument with the command-line LDAP tools `ldapadd`, `ldapaddmt`, `ldapbind`, `ldapcompare`, `ldapmoddn`, `ldapmod`, `ldapdelete`, and `ldapsearch`. You do not need to use the `-E character_set` argument if `NLS_LANG` is set.

Use the `encode="character_set"` argument with the command-line bulk tools `bulkload`, `bulkmodify`, `bulkdelete`, and `ldifwrite`, where `character_set` is the character set used in the LDIF file. Set `NLS_LANG` to the character set used by the directory's database.

Oracle Internet Directory tools automatically decode BASE64 encoded native strings to simple native strings. The native strings are then converted to the equivalent UTF-8 strings.

Note: In any given input file, only one character set may be used.

Using Globalization Support with Command-Line LDAP Tools

The Oracle Internet Directory command-line tools read keyboard input or LDIF file input in the following ways:

- ASCII characters only
- Non-ASCII input (native language character set)
- BASE64 encoded values of UTF-8 or native strings (from LDIF file only)

If the character set being given as input from an LDIF file or keyboard is not UTF-8, then the command-line tools need to convert the input into UTF-8 format before sending it to the LDAP server.

You enable the command-line tools to convert the input into UTF-8 by specifying the `-E character_set` argument with any of the command-line LDAP tools. Use the `encode="character_set"` argument with `bulkload`, `bulkmodify`, `bulkdelete`, and `ldifwrite`.

This section contains these topics:

- [Specifying the -E Argument When Using Each Tool](#)
- [Examples: Using the -E Argument with Command-Line LDAP Tools](#)

Specifying the -E Argument When Using Each Tool

The client tools always assume UTF-8 (the Oracle character set name is AL32UTF8) to be the character set unless otherwise specified by the `-E` argument. The BASE64-encoded values are decoded, and then the decoded buffer is converted to UTF-8 if the `-E` argument is specified. For example, if you specify `-E ".ZHS16GBK"`, then the decoded buffer is converted from simplified Chinese GBK to Unicode UTF-8 before being sent to the directory server.

Specifying the `-E` argument ensures that proper character set conversion can occur from the character set you specify for the `-E` argument (`-E ".character_set"`) to the AL32UTF8 character set.

The command-line tools use the `-E` argument to process the input in the character set specified for the `-E` argument. They display their output in the character set specified in the `NLS_LANG` environment variable.

For example, to add entries from an LDIF file encoded in the simplified Chinese character set (ZHS16GBK) by using `ldapadd`, type:

```
ldapadd -h myhost -p 3060 -E ".ZHS16GBK" -D cn=orcladmin -q -f my_ldif_file
```

In this example, the `ldapadd` tool converts the characters from `".ZHS16GBK"` (simplified Chinese character set) to `".AL32UTF8"` before they are sent across the wire to the directory server.

Examples: Using the -E Argument with Command-Line LDAP Tools

[Table I-3](#) provides additional examples of how to use the `-E` argument correctly for each command-line tool. In each example, the command converts data from simplified Chinese, as specified by the value `".ZHS16GBK"`, to AL32UTF8. For example, in each command, the value for the `-D` option and the password typed at the prompt when `-q` is specified are in GBK. Specifying the `-E` argument converts them to UTF-8.

Note that, in the examples in [Table I-3](#), we do not show any actual characters belonging to the `.ZHS16GBK` character set. These examples would, therefore, work without the `-E` argument. However, if the argument values contained actual characters in the `.ZHS16GBK` character set, then we would need to use the `-E` argument.

See Also: "Oracle Internet Directory Administration Tools" in *Oracle Fusion Middleware Reference for Oracle Identity Management* for syntax and usage notes for each of the command-line tools

Table I-3 Examples: Using the -E Argument with Command-Line Tools

Tool	Example
ldapbind	ldapbind -h my_host -p 3060 -E ".ZHS16GBK" -D "o=example,c=us" -q
ldapsearch	ldapsearch -h my_host -p 3060 -E ".ZHS16GBK" -D "o=example,c=us" -q
ldapadd	ldapadd -h my_host -p 3060 -E ".ZHS16GBK" -D "o=example,c=us" -q
ldapaddmt	ldapaddmt -h my_host -p 3060 -E ".ZHS16GBK" -D "o=example,c=us" -q
ldapmodify	ldapmodify -h my_host -p 3060 -E ".ZHS16GBK" -D "o=example,c=us" -q
ldapmodifymt	ldapmodifymt -h my_host -p 3060 -E ".ZHS16GBK" -D "o=example,c=us" -q
ldapdelete	ldapdelete -h my_host -p 3060 -E ".ZHS16GBK" -D "o=example,c=us" -q
ldapcompare	ldapcompare -h my_host -p 3060 -E ".ZHS16GBK" -D "o=example,c=us" \ -b "ou=Construction,ou=Manufacturing,o=example,c=us" \ -a title -v manager -q
ldapmoddn	ldapmoddn -h my_host -p 3060 -E ".ZHS16GBK" -D "o=example,c=us" \ -b "cn=Frank Smith,ou=Construction,ou=Manufacturing,c=us, o=example"\ -N "ou=Contracting,ou=Manufacturing,o=example,c=us" -r -q

Setting NLS_LANG in the Client Environment

If the output required by the client is UTF-8, then you do not need to set the NLS_LANG environment variable. In this case, the character set component of the NLS_LANG environment variable defaults to AL32UTF8, and both the input path from client to server, and the output path from server to client, do not require any character set conversion.

If the output required by the client is *not* UTF-8, then you must set the NLS_LANG environment variable. This ensures that proper character set conversion can occur from the AL32UTF8 character set to the character set required by the client.

For example, if the NLS_LANG environment variable is set to the simplified Chinese character set, then the command-line tool displays output in that character set. Otherwise the output defaults to the AL32UTF8 character set.

Note: If you are using Microsoft Windows, then, to use the command-line tools after server startup, you must reset NLS_LANG in an MS-DOS window. Set it to the character set that matches the code page of your MS-DOS session. AL32UTF8 cannot be used. See the *Oracle Database Installation Guide for Microsoft Windows* for more information on which character set to use for command-line tools in an MS-DOS session.

If you are using a pre-installed Oracle Database with Oracle Internet Directory, then you must also set the database character set to AL32UTF8.

See Also: *Oracle Database Globalization Support Guide* in the Oracle Database Documentation Library and *Oracle Database Installation Guide for Microsoft Windows*

Be careful not to change the NLS_LANG parameter value in the registry.

Using Globalization Support with Bulk Tools

Oracle Internet Directory ensures that the reading and writing of text data from and to LDIF files are done in UTF-8 encoding as specified by the LDAP standard.

This section provides an example of the argument you use for each of the following bulk tools:

- [Using Globalization Support with bulkload](#)
- [Using Globalization Support with ldifwrite](#)
- [Using Globalization Support with bulkdelete](#)
- [Using Globalization Support with bulkmodify](#)

See Also: "Oracle Internet Directory Administration Tools" in *Oracle Fusion Middleware Reference for Oracle Identity Management* for a list of arguments for each bulk tool

Using Globalization Support with bulkload

Add to the command the argument `encode="character_set"` where the input LDIF file is encoded in `"character_set"`.

For example, ensure that `ORACLE_INSTANCE` is set, then type:

```
bulkload connect="connect_string" \
  encode=".ZHS16GBK" check="TRUE" generate="TRUE" file="my_ldif_file"
```

Using Globalization Support with ldifwrite

The `ldifwrite` utility always writes BASE64 encoded values for multibyte strings.

The BASE64 encoding could be of the UTF-8 strings as they are stored in the directory server, or of native strings as specified by the `NLS_LANG` environment variable setting when running `ldifwrite`.

For example:

```
ldifwrite connect="connect_string" baseDN="baseDN" ldiffile="output_file"
```

In this example, if the `NLS_LANG` environment variable is not set, or is set to `language_territory.AL32UTF8`, then the output LDIF file will contain BASE64-encoded UTF-8 strings for any multibyte characters.

For information about loading this LDIF file into a directory, see ["CASE 3: BASE64 Encoded UTF-8 Strings"](#) on page I-5.

If the `NLS_LANG` environment variable is set to a character set other than `AL32UTF8`—for example, `".ZHS16GBK"`—then the output LDIF file will contain a BASE64 encoded value of simplified Chinese GBK strings.

For information about loading this LDIF file into the directory, see ["CASE 4: BASE64 Encoded Native Strings"](#) on page I-5.

Using Globalization Support with bulkdelete

Add `encode="character_set"` to the command.

For example:

```
bulkdelete connect="connect_string" encode=".ZHS16GBK" \
  baseDN="ou=manufacturing,o=example,c=us"
```

In this case the value for the `-base` option could be in the ZHS16GBK native character set, that is, simplified Chinese.

Using Globalization Support with `bulkmodify`

Add `encode="character_set"` to the command the argument.

For example:

```
bulkmodify connect="my_service_name" \  
           encode=".ZHS16GBK" basedn="ou=manufacturing,o=example,c=us" \  
           replace=TRUE value=Foreman filter="objectclass=*
```

In this example, values for the `basedn`, `value`, and `filter` arguments can be specified using the simplified Chinese GBK character set.

Setting up Access Controls for Creation and Search Bases for Users and Groups

If you modify the User Search Base, the User Creation Base, the Group Search Base, or the Group Creation Base, then access controls for the new container need to be set up properly. This appendix contains these topics:

- [Setting up Access Controls for the User Search Base and the User Creation Base](#)
- [Setting up Access Controls for the Group Search Base and the Group Creation Base](#)

Setting up Access Controls for the User Search Base and the User Creation Base

To set up access controls for the User Search Base and the User Creation Base:

1. Create an LDIF (`user_aci.ldif`) file with the following entry:

```
--- BEGIN LDIF file contents---
dn: %usersearch_or_createbase_dn%
changetype: modify
add: orclaci
orclaci: access to entry by group="cn=oracledascreateuser,
cn=groups,cn=OracleContext,%subscriberdn%"
added_object_constraint=(objectclass=orcluser*) (browse,add) by
group="cn=Common User Attributes, cn=Groups,
cn=OracleContext,%subscriberdn%" (browse) by
group="cn=PKIAdmins, cn=groups, cn=OracleContext,%subscriberdn%" (browse)
orclaci: access to entry filter=(objectclass=inetorgperson) by
group="cn=oracledascreateuser, cn=groups,cn=OracleContext,%subscriberdn%"
added_object_constraint=(objectclass=orcluser*) (browse,add) by
group="cn=oracledasdeleteuser, cn=groups,cn=OracleContext,%subscriberdn%"
(browse,delete) by group="cn=oracledasedituser,
cn=groups,cn=OracleContext,%subscriberdn%" (browse) by
group="cn=UserProxyPrivilege, cn=Groups,cn=OracleContext,%subscriberdn%"
(browse,
proxy) by dn="orclApplicationCommonName=DASApp, cn=DAS,
cn=Products,cn=oraclecontext" (browse,proxy) by self (browse, nodelete, noadd)
by
group="cn=Common User Attributes, cn=Groups,cn=OracleContext,%subscriberdn%"
(browse) by * (browse, noadd, nodelete)
orclaci: access to attr=(*) filter=(objectclass=inetorgperson) by
group="cn=oracledasedituser, cn=groups,cn=OracleContext,
%subscriberdn%" (read,search,write,compare) by self (
read,search,write,selfwrite,compare) by *
(read, nowrite, nocompare)
```

```

orclaci: access to attr=(userPassword)
  filter=(objectclass=inetorgperson) by
  group="cn=OracleUserSecurityAdmins,cn=Groups,
  cn=OracleContext,%subscriberdn%"
  (read,search,write,compare) by group="cn=oracledasedituser,
  cn=groups,cn=OracleContext,%subscriberdn%"
  (read,search,write,compare) by self
  (read,search,write,selfwrite,compare) by group="cn=authenticationServices,
  cn=Groups,cn=OracleContext,%subscriberdn%" (compare) by * (none)
orclaci: access to attr=(authpassword, orclpasswordverifier, orclpassword) by
  group="cn=oracledasedituser,cn=groups,cn=OracleContext,%subscriberdn%"
  (read,search,write,compare) by
  group="cn=verifierServices,cn=Groups,cn=OracleContext,%subscriberdn%"
  (search, read, compare) by self (search,read,write,compare) by * (none)
orclaci: access to attr=(orclpwdaccountunlock) by
  group="cn=oracledasedituser,cn=groups,cn=OracleContext,%subscriberdn%" (
  write) by * (none)
orclaci: access to attr=(usercertificate, usersmimecertificate) by
  group="cn=PKIAdmins,cn=Groups,cn=OracleContext,%subscriberdn%"
  (read, search, write, compare) by self (read, search, compare) by *
  (read, search, compare)
orclaci: access to attr=(mail) by
  group="cn=EmailAdminsGroup,cn=EmailServerContainer,cn=Products,
  cn=OracleContext" (write) by group="cn=oracledasedituser,
  cn=groups,cn=OracleContext,%subscriberdn%" (read,search,write,compare)
orclaci: access to attr=(orclguid, orclisenabled, modifytimestamp,mail)
  by group="cn=Common User Attributes,
  cn=Groups,cn=OracleContext,%subscriberdn%"
  (read, search, compare) by group="cn=oracledasedituser,
  cn=groups,cn=OracleContext,%subscriberdn%" (read,search,write,compare)
  by * (read, nowrite, nocompare)
orclaci: access to attr=(orclpasswordhintanswer) by
  group="cn=Common User Attributes,
  cn=Groups,cn=OracleContext,%subscriberdn%" (read, search, compare) by self
  (read,search,write,selfwrite,compare) by * (noread, nowrite, nocompare)
orclaci: access to attr=(orclpasswordhint) by
  group="cn=Common User Attributes,
  cn=Groups,cn=OracleContext,%subscriberdn%" (read, search, compare) by self
  (read,search,write,selfwrite,compare) by
  group="cn=OracleUserSecurityAdmins,cn=Groups,cn=OracleContext,
  %subscriberdn%" (read,search,write,compare) by *
  (noread, nowrite, nocompare)
orclaci: access to attr=(displayName, preferredlanguage,
  orcltimezone,orcldateofbirth,orclgender,orclwirelessaccountnumber,cn,
  uid,homephone,telephonenumber) by group="cn=Common User Attributes,
  cn=Groups,cn=OracleContext,%subscriberdn%"
  (read, search, compare) by group="cn=oracledasedituser,
  cn=groups,cn=OracleContext,%subscriberdn%" (read,search,write,compare)
  by self (read,search,write,selfwrite,compare) by *
  (read, nowrite, nocompare)
-
add: orclentrylevelaci
orclentrylevelaci: access to entry by group="cn=oracledascreateuser,
  cn=groups,cn=OracleContext,%subscriberdn%" added_object_constraint=
  (objectclass=orcluser*) (browse, add) by * (browse)
---END LDIF file contents-----

```

2. Replace %subscriberdn% with the dn of the subscriber and %usersearch_or_createbase_dn% with the new value of the container DN where the new user search/create base points to.

3. Run the ldapmodify command as follows:

```
ldapmodify -p oidport -h oidhost -D cn=orcladmin -q -v \
-f user_aci.ldif
```

Setting up Access Controls for the Group Search Base and the Group Creation Base

To set up access controls for the Group Search Base and the Group Creation Base:

1. Create an ldif (group_aci.ldif) file with the following entry:

```
--- BEGIN LDIF file contents---
dn: %groupsearch_or_createbase_dn%
changetype: modify
add: orclaci
orclaci: access to entry by group="cn=IASAdmins,
cn=groups,cn=OracleContext,%subscriberdn%"
added_object_constraint=(objectclass=orclcontainer) (browse,add)
orclaci: access to entry by group="cn=oracledascreategroup,
cn=groups,cn=OracleContext,%subscriberdn%"
added_object_constraint=(objectclass=orclgroup*) (browse,add) by
group="cn=Common
Group Attributes, cn=Groups,cn=OracleContext,%subscriberdn%" (browse)
orclaci: access to entry filter=(&(objectclass=orclgroup) (orclisvisible=false))
by
groupattr=(owner) (browse, add, delete) by dnattr=(owner)
(browse, add, delete) by
group="cn=Common Group Attributes, cn=Groups,cn=OracleContext,%subscriberdn%"
(browse) by * (none)
orclaci: access to entry
filter=(&(objectclass=orclgroup) (!(orclisvisible=false))) by
group="cn=oracledascreategroup, cn=groups,cn=OracleContext,%subscriberdn%"
added_object_constraint=(objectclass=orclgroup) (browse,add) by
group="cn=oracledasdeletigroup, cn=groups,cn=OracleContext,%subscriberdn%"
(browse,delete) by group="cn=oracledaseditgroup,
cn=Groups,cn=OracleContext,%subscriberdn%" (browse) by groupattr=(owner) (
browse,
add, delete) by dnattr=(owner) (browse, add, delete) by group="cn=Common Group
Attributes, cn=Groups,cn=OracleContext,%subscriberdn%" (browse)
orclaci: access to attr=(*)
filter=(&(objectclass=orclgroup) (orclisvisible=false)) by
groupattr=(owner) (read,search,write,compare) by dnattr=(owner)
(read,search,write,compare) by * (none) by group="cn=Common Group Attributes,
cn=Groups,cn=OracleContext,%subscriberdn%" (read, search, compare)
orclaci: access to attr=(*)
filter=(&(objectclass=orclgroup) (!(orclisvisible=false))) by
groupattr=(owner) (read,search,write,compare) by dnattr=(owner)
(read,search,write,compare) by group="cn=oracledaseditgroup,
cn=groups,cn=OracleContext,%subscriberdn%" (read,search,write,compare) by
group="cn=Common Group Attributes, cn=Groups,cn=OracleContext,%subscriberdn%"
(read, search, compare)
-
add: orclentrylevelaci
orclentrylevelaci: access to entry by group="cn=oracledascreategroup,
cn=groups,cn=OracleContext,%subscriberdn%"
added_object_constraint=(objectclass=orclgroup) (browse, add) by
group="cn=IASAdmins, cn=groups,cn=OracleContext,%subscriberdn%"
added_object_constraint=(objectclass=orclcontainer) (browse,add) by * (browse)
---END LDIF file contents-----
```

2. Replace `%subscriberdn%` with the DN of the subscriber and `%groupsearch_or_createbase_dn%` with the new value of the container DN where the new group search base or group create base points to.

3. Run the `ldapmodify` command as follows:

```
ldapmodify -p oidport -h oidhost -D cn=orcladmin -q -v -f group_aci.ldif
```

Searching the Directory for User Certificates

Starting with 10g (10.1.4.0.1), you can perform a command-line search of the binary attribute `usercertificate`.

Before 10g Release 2 (10.1.2.0.2), the only way to identify a user from the certificate was through the DN specified in the certificate. This is known as certificate matching. Starting with 10g Release 2 (10.1.2.0.2), Oracle Internet Directory supports certificate mapping, in addition to certificate matching. Certificate matching requires that a user certificate be provisioned in the directory. Certificate mapping does not require provisioning of a user certificate.

This chapter includes the following topics:

- [Certificate Mapping](#)
- [Search Types](#)

Certificate Mapping

Certificate mapping allows a customer to define rules for mapping the certificate to the user's DN. A certificate mapping rule is a set of rules for parsing the certificate and for querying the directory for the user's identity. Only custom extensions of certificates can be used in mapping rules.

The following examples show how to add, delete, and modify a certificate mapping rule.

Adding a Certificate Mapping Rule

Add a mapping rule using `ldapmodify`, as follows:

```
ldapmodify -D "cn=orcladmin" -q -h hostName -p port_number -f certMapRuleAdd.ldif
```

The file `certMapRuleAdd.ldif` should look something like this:

```
dn: cn=maprule1,cn=SASL-EXTERNAL,cn=Identity Mapping Configurations,cn=Server  
Configurations  
cn: maprule1  
objectclass: orclidmapping  
objectclass: orlcertidmapping  
orclSearchScope: subtree  
orclSearchFilter: (cn=$(2.16.750.5.14.2.81.2.5.1))  
orlcertExtensionOID: 2.16.750.5.14.2.81.2.5  
orlcertExtensionAttribute: 2.16.750.5.14.2.81.2.5.1
```

Deleting a Certificate Mapping Rule

Delete a mapping rule using `ldapdelete`, as follows:

```
ldapdelete hostName -D "cn=orcladmin" -q -p port_number \
  "cn=maprule1,cn=SASL-EXTERNAL,cn=Identity Mapping Configurations,cn=Server \
  Configurations"
```

Modifying a Certificate Mapping Rule

Modify a mapping rule using `ldapmodify`, as follows:

```
ldapmodify -D "cn=orcladmin" -q -h hostName -p port_number -f certMapRuleMod.ldif
```

The file `certMapRuleMod.ldif` should look something like this:

```
dn: cn=maprule1,cn=SASL-EXTERNAL,cn=Identity Mapping Configurations,cn=Server
Configurations
changetype:modify
replace: attrName
attrName: attrValue
```

Search Types

You can use two kinds of certificate search filters:

- A filter of the form `"usercertificate=certificate_serial_number$certificate_issuer_DN"`. A combination of the certificate serial number and the certificate issuer's DN is used to locate the certificate. This combination is called the certificate match value.
- A filter of the form `"usercertificate;binary=base_64_encoded_value_of_certificate"`. Using this filter, one of six types of searches is possible, depending upon two things:
 - The value of the DSA configuration set attribute (DN: `"cn=dsaconfig,cn=configsets,cn=oracle internet directory"`), `orclpkimatchingrule`.
 - The presence or absence of the LDAP control `GSL_CERTIFICATE_CONTROL, 2.16.840.1.113894.1.8.23`

The six types of searches possible with a filter of the form

`"usercertificate;binary=base_64_encoded_value_of_certificate"` are:

Presence of LDAP control	Value of <code>orclpkimatchingrule</code>	Search Behavior
Absent	Not used	The hashed value of the client certificate is used to locate <code>usercertificate</code> .
Present	0	An exact-match search is performed. The subject DN of the client certificate is the search base. This DN is compared with the user DN in the directory. The search scope is Base. The filter is <code>"objectclass=*"</code> .
Present	1	The hashed value of the client certificate is used to locate <code>usercertificate</code> .

Presence of LDAP control	Value of orclpkimatchingrule	Search Behavior
Present	2 (Default)	The hashed value of the client certificate is used to locate <code>usercertificate</code> . If this search yields nothing, An exact-match search is performed.
Present	3	The mapping rule is used.
Present	4	First, the mapping rule is used. If that search yields nothing, then the search proceeds as if the value were 2.

For information on using LDAP controls, see "Extensions to the LDAP Protocol" in *Oracle Fusion Middleware Application Developer's Guide for Oracle Identity Management*.

Notes:

- The `usercertificate` attribute cannot be searched using a substring filter.
 - In an exact-match search, the search filter can contain only one attribute value assertion.
 - Only one-level and subtree searches are supported.
 - The `catalog` tool does not support catalogs for user certificates—namely `ct_orclcertificatehash` and `ct_orclcertificatematch`
 - The introduction in 10g (10.1.4.0.1) of certificate hash values requires that certificates be upgraded from earlier releases. See the `upgradecert.pl` command-line tool reference in *Oracle Fusion Middleware Reference for Oracle Identity Management*.
-
-

See Also: ["Direct Authentication"](#) on page 32-1

Adding a Directory Node by Using the Database Copy Procedure

This appendix explains how to add a new node to an existing replicating system by using the database copy procedure, also known as cold backup. This procedure works only for Oracle Internet Directory. Do not employ this procedure if other Oracle Identity Management components, such as Oracle Single Sign-On, are installed. You can use the database copy procedure to create a new directory replication group (DRG) if you have a standalone Oracle Internet Directory node. This procedure is applicable for an Oracle Database Advanced Replication-based replica and for a full LDAP-based replica.

Definitions

The sponsor site refers to the site or host or node where Oracle Internet Directory and its repository, the Oracle database, are installed. The sponsor site is also referred to as sponsor node.

The new site refers to the site or host or node to which you are copying the Oracle Internet Directory repository. The new site is also referred to as the new node.

Prerequisites

Your computing environment must meet the following prerequisites before you start this procedure:

1. The operating system, version, and patch level of the new directory site must be the same as that of the sponsor directory site. This procedure might not work if the patch levels of the operating systems differ.
2. Oracle strongly recommends that you back up the sponsor directory's repository before you employ this procedure.
3. Because this procedure involves copying Oracle data files, performance depends on the underlying network. If the underlying network is slow, consider using one of the methods described in [Chapter 38, "Setting Up Replication"](#) or [Appendix C, "Setting Up Oracle Database Advanced Replication-Based Replication"](#) to set up a replication group. Alternatively, you could physically transfer compressed Oracle data files on removable media. Consult your local system or network administrator for information about the network.
4. Only a person familiar with the Oracle database should perform this procedure.
5. If the sponsor site is already a part of an Advanced Replication group, the sponsor node must be the Master definition site (MDS).

Sponsor Directory Site Environment

In the example shown throughout this chapter, the sponsor directory site's environment is as follows:

```
Hostname = rst-sun
Domain name = example.com
ORACLE_BASE = /private/oracle/app/oracle
ORACLE_HOME = /private/oracle/app/oracle/product/OraHome_1
ORACLE_SID = LDAP
LD_LIBRARY_PATH = $ORACLE_HOME/lib
NLS_LANG = AMERICAN_AMERICA.AL32UTF8
datafile location = /private/oracle/oradata/LDAP
Dump destination = /private/oracle/app/oracle/admin/LDAP/pfile,
                  /private/oracle/app/oracle/admin/LDAP/bdump,
                  /private/oracle/app/oracle/admin/LDAP/cdump,
                  /private/oracle/app/oracle/admin/LDAP/udump,
                  /private/oracle/app/oracle/admin/LDAP/create
```

New Directory Site Environment

In the example shown throughout this chapter, the new directory site's environment is as follows:

```
Hostname = dsm-sun
Domain name = example.com
ORACLE_BASE = /privatel/oracle/app/oracle
ORACLE_HOME = /privatel/oracle/app/oracle/product/OraHome_1
ORACLE_SID = NLDAP
LD_LIBRARY_PATH = $ORACLE_HOME/lib
NLS_LANG = AMERICAN_AMERICA.AL32UTF8
datafile location = /privatel/oracle/oradata/NLDAP
Dump destination = /privatel/oracle/app/oracle/admin/NLDAP/pfile,
                  /privatel/oracle/app/oracle/admin/NLDAP/bdump,
                  /privatel/oracle/app/oracle/admin/NLDAP/cdump,
                  /privatel/oracle/app/oracle/admin/NLDAP/udump,
                  /privatel/oracle/app/oracle/admin/NLDAP/create
```

Everything except the hostname and domain name is created during installation of the Oracle Database in Step 10.

Addition of a Directory Node

1. Install the node and check its status, as follows:
 - a. Install Identity Management with the Oracle Internet Directory component on the sponsor node. See *Oracle Fusion Middleware Installation Guide for Oracle Identity Management*

See Also:

- *Oracle Database Installation Guide* for your operating system
- *Oracle Fusion Middleware Getting Started With Installation for Oracle WebLogic Server*
- *Oracle Fusion Middleware Installation Planning Guide*

- b. To check the status of Oracle Internet Directory, type:

```
$ cd ORACLE_INSTANCE/bin
```

```
$ ./opmnctl status
```

The status should be `Alive`.

2. Shut down Oracle Internet Directory and all other `opmn` processes on the sponsor node, as follows:

```
$ cd ORACLE_INSTANCE/bin
$ opmnctl stopall
```

3. Perform the following steps on the sponsor node.

- a. At the command line prompt execute the following SQL*Plus commands:

```
$ sqlplus /nolog
SQL> connect / as sysdba
SQL> ALTER DATABASE BACKUP CONTROLFILE TO TRACE RESETLOGS;
```

This command sequence creates a trace file under the user dump destination directory.

To determine the location of the user dump destination directory, execute the following command:

```
SQL> show parameter user_dump_dest;
```

The name of the newly-created trace file is of the form:

```
ORACLE_SID_ora_processid.trc
```

- b. Shut down the database and Oracle Net Services listener on the sponsor node. By default, the listener name is `LISTENER`. Type:

```
$ lsnrctl stop
$ sqlplus /nolog
SQL> connect / as sysdba
SQL> shutdown
SQL> exit
```

- c. If the copied node is part of an Advanced Replication-based DRG, perform the following steps:

- On other nodes of the DRG, shut down the LDAP replication server only.

```
$ oidctl connect=connect_string server=oidrepld \
instance=instance_number stop
```

Repeat this procedure on all nodes except the sponsor node. Specify appropriate net service names for the corresponding nodes.

- If you are adding a node to an existing DRG, quiesce Oracle Database Advanced Replication by using SQL*Plus. Execute the following commands at the master definition site (MDS) only:

```
$ cd ORACLE_HOME/ldap/admin
$ sqlplus /nolog
SQL> connect repadmin/repadmin_password;
SQL> @oidrsusp.sql
```

Note: Perform this SQL*Plus procedure only on the master definition site.

Now that you have stopped replication, you can safely modify other nodes.

- d. Rename the trace file created in Step 3a to `newdb.sql`, under the same directory.

```
$ cp ORACLE_SID_ora_processid.trc newdb.sql
```

4. On the sponsor node, open `newdb.sql` in a text editor and delete all the lines except the `STARTUP NOMOUNT` and `CREATE CONTROLFILE` statements. After deleting those lines, `newdb.sql` should look like this:

```
STARTUP NOMOUNT
CREATE CONTROLFILE REUSE SET DATABASE "LDAP" RESETLOGS NOARCHIVELOG
  MAXLOGFILES 16
  MAXLOGMEMBERS 3
  MAXDATAFILES 100
  MAXINSTANCES 8
  MAXLOGHISTORY 454
LOGFILE
  GROUP 1 '/private/oracle/oradata/LDAP/redo01.log' SIZE 10M,
  GROUP 2 '/private/oracle/oradata/LDAP/redo02.log' SIZE 10M,
  GROUP 3 '/private/oracle/oradata/LDAP/redo03.log' SIZE 10M
-- STANDBY LOGFILE
DATAFILE
  '/private/oracle/oradata/LDAP/system01.dbf',
  '/private/oracle/oradata/LDAP/sysaux01.dbf',
  '/private/oracle/oradata/LDAP/users01.dbf',
  '/private/oracle/oradata/LDAP/dcm.dbf',
  '/private/oracle/oradata/LDAP/portal.dbf',
  '/private/oracle/oradata/LDAP/ptldoc.dbf',
  '/private/oracle/oradata/LDAP/ptlidx.dbf',
  '/private/oracle/oradata/LDAP/ptllog.dbf',
  '/private/oracle/oradata/LDAP/oca.dbf',
  '/private/oracle/oradata/LDAP/discopltc1.dbf',
  '/private/oracle/oradata/LDAP/discopltm1.dbf',
  '/private/oracle/oradata/LDAP/oss_sys01.dbf',
  '/private/oracle/oradata/LDAP/wcrsys01.dbf',
  '/private/oracle/oradata/LDAP/uddisys01.dbf',
  '/private/oracle/oradata/LDAP/b2b_dt.dbf',
  '/private/oracle/oradata/LDAP/b2b_rt.dbf',
  '/private/oracle/oradata/LDAP/b2b_idx.dbf',
  '/private/oracle/oradata/LDAP/b2b_lob.dbf',
  '/private/oracle/oradata/LDAP/bam.dbf',
  '/private/oracle/oradata/LDAP/orabpel.dbf',
  '/private/oracle/oradata/LDAP/attrs1_oid.dbf',
  '/private/oracle/oradata/LDAP/battrs1_oid.dbf',
  '/private/oracle/oradata/LDAP/gcats1_oid.dbf',
  '/private/oracle/oradata/LDAP/gdefault1_oid.dbf',
  '/private/oracle/oradata/LDAP/svrmg1_oid.dbf',
  '/private/oracle/oradata/LDAP/ias_meta01.dbf',
  '/private/oracle/oradata/LDAP/undotbs.dbf'
CHARACTER SET AL32UTF8
;
```

5. Continue editing the file `newdb.sql` on the sponsor node, as follows:
 - a. Change the line:

```
CREATE CONTROLFILE REUSE DATABASE "LDAP" RESETLOGS NOARCHIVELOG
```

to:

```
CREATE CONTROLFILE REUSE SET DATABASE "NLDAP" RESETLOGS NOARCHIVELOG
```

- b. Modify the UNIX directory location of the database and logfiles to point to the new node site's directory.

In our example, after these modifications, `newdb.sql` should look like this:

```
STARTUP NOMOUNT
CREATE CONTROLFILE REUSE SET DATABASE "NLDAP" RESETLOGS NOARCHIVELOG
    MAXLOGFILES 16
    MAXLOGMEMBERS 3
    MAXDATAFILES 100
    MAXINSTANCES 8
    MAXLOGHISTORY 454
LOGFILE
    GROUP 1 '/private1/oracle/oradata/NLDAP/redo01.log' SIZE 10M,
    GROUP 2 '/private1/oracle/oradata/NLDAP/redo02.log' SIZE 10M,
    GROUP 3 '/private1/oracle/oradata/NLDAP/redo03.log' SIZE 10M
-- STANDBY LOGFILE
DATAFILE
    '/private1/oracle/oradata/NLDAP/system01.dbf',
    '/private1/oracle/oradata/NLDAP/sysaux01.dbf',
    '/private1/oracle/oradata/NLDAP/users01.dbf',
    '/private1/oracle/oradata/NLDAP/dcm.dbf',
    '/private1/oracle/oradata/NLDAP/portal.dbf',
    '/private1/oracle/oradata/NLDAP/ptldoc.dbf',
    '/private1/oracle/oradata/NLDAP/ptlidx.dbf',
    '/private1/oracle/oradata/NLDAP/ptllog.dbf',
    '/private1/oracle/oradata/NLDAP/oca.dbf',
    '/private1/oracle/oradata/NLDAP/discoplct1.dbf',
    '/private1/oracle/oradata/NLDAP/discoplmt1.dbf',
    '/private1/oracle/oradata/NLDAP/oss_sys01.dbf',
    '/private1/oracle/oradata/NLDAP/wcrsys01.dbf',
    '/private1/oracle/oradata/NLDAP/uddisys01.dbf',
    '/private1/oracle/oradata/NLDAP/b2b_dt.dbf',
    '/private1/oracle/oradata/NLDAP/b2b_rt.dbf',
    '/private1/oracle/oradata/NLDAP/b2b_idx.dbf',
    '/private1/oracle/oradata/NLDAP/b2b_lob.dbf',
    '/private1/oracle/oradata/NLDAP/bam.dbf',
    '/private1/oracle/oradata/NLDAP/orabpel.dbf',
    '/private1/oracle/oradata/NLDAP/attrs1_oid.dbf',
    '/private1/oracle/oradata/NLDAP/battr1_oid.dbf',
    '/private1/oracle/oradata/NLDAP/gcats1_oid.dbf',
    '/private1/oracle/oradata/NLDAP/gdefault1_oid.dbf',
    '/private1/oracle/oradata/NLDAP/svrmg1_oid.dbf',
    '/private1/oracle/oradata/NLDAP/ias_meta01.dbf',
    '/private1/oracle/oradata/NLDAP/undotbs.dbf'
CHARACTER SET AL32UTF8
;
```

6. Copy the initialization parameter file `init$ORACLE_SID.ora` from the sponsor directory's database to `init$ORACLE_SID_NEW_DIR_DB.ora`. The default location of the initialization parameter file is `$ORACLE_HOME/dbs` on UNIX or Linux and `%ORACLE_HOME%\database` on Windows. In our example, copy `/private/oracle/app/oracle/product/OraHome_1/dbs/initLDAP.ora` to `/private/oracle/app/oracle/product/OraHome_1/dbs/initNLDAP.ora` as shown here:

```
$ cd ORACLE_HOME/dbs
$ cp initLDAP.ora initNLDAP.ora
```

If you are using the server parameter file `spfile$ORACLE_SID.ora` or `spfile.ora` instead of an initialization parameter file, create an initialization parameter file from the server parameter file. For example, if `spfile$ORACLE_SID.ora` is located in the default location `$ORACLE_HOME/dbs` you would type:

```
$ sqlplus /nolog
SQL> connect / as sysdba
SQL> create pfile from spfile
SQL> shutdown immediate
```

This sequence of commands creates an `initLDAP.ora` file at `/private/oracle/app/oracle/product/OraHome_1` from `spfileLDAP.ora`. If the server parameter file is not located in the default location, you must include the complete path, as shown in the following example:

```
SQL> connect / as sysdba
SQL> create pfile='/private/oracle/initLDAP.ora' from
  spfile=/private/oracle/initLDAP.ora
SQL> shutdown immediate
```

After you create the initialization file parameter file, create a copy of it as explained at the beginning of this step.

7. In the new initialization parameter file on the sponsor, make the following changes:
 - a. Comment out the parameter `JOB_QUEUE_PROCESSES`, if it exists.
 - b. Change the parameter `dbname` from `LDAP` to `NLDAP`.
 - c. If the new site's domain name is different from the sponsor directory's domain name, alter the parameter `db_domain` also.

- d. Alter the location of the following parameters to point to the location of the new site.

```
background_dump_dest
core_dump_dest
user_dump_dest
control_files
db_recovery_file_dest
```

- e. In addition to the parameters listed in Step 7d, if your initialization parameter file has any parameters that are node specific, such as `DB_RECOVERY_FILE_DEST` and `DB_CREATE_FILE_DEST`, alter those parameters as well.

In our example, the initialization parameter file `initNLDAP.ora` looks like this after these modifications:

```
*.aq_tm_processes=1
*.background_dump_dest='/private1/oracle/app/oracle/admin/NLDAP/bdump'
*.compatible='10.1.0.2.0'
*.control_files='/private1/oracle/app/oracle/admin/NLDAP/control01.ctl',
  '/private1/oracle/app/oracle/admin/NLDAP/control02.ctl',
  '/private1/oracle/app/oracle/admin/NLDAP/control03.ctl'
*.core_dump_dest='/private1/oracle/app/oracle/admin/NLDAP/cdump'
*.db_block_size=8192
*.db_cache_size=50331648
*.db_domain='example.com'
*.db_file_multiblock_read_count=16
*.db_name='NLDAP'
*.db_recovery_file_dest='/private/oracle1/app/oracle/flash_recovery_area'
*.db_recovery_file_dest_size=2147483648
```

```
*.dispatchers='(PROTOCOL=TCP) (PRE=oracle.aurora.server.GiopServer)',
              '(PROTOCOL=TCP) (PRE=oracle.aurora.server.SGiopServer)'
*.java_pool_size=67108864
#*.job_queue_processes=5
*.large_pool_size=8388608
*.max_commit_propagation_delay=0
*.open_cursors=300
*.pga_aggregate_target=33554432
*.processes=150
*.remote_login_passwordfile='EXCLUSIVE'
*.sessions=400
*.shared_pool_size=150994944
*.undo_management='AUTO'
*.undo_tablespace='UNDOTBS'
*.user_dump_dest='/private1/oracle/app/oracle/admin/NLDAP/udump'
```

8. Edit the `tnsnames.ora` file to include connection details for the new node. Refer to the following sample file:

```
LDAP.ACME.COM =
  (DESCRIPTION =
    (ADDRESS = (PROTOCOL = TCP) (HOST = rst-sun) (PORT = 1521))
    (CONNECT_DATA =
      (SERVER = DEDICATED)
      (SERVICE_NAME = ldap.acme.com)
    )
  )
NLDAP.ACME.COM =
  (DESCRIPTION =
    (ADDRESS = (PROTOCOL = TCP) (HOST = dsm-sun) (PORT = 1521))
    (CONNECT_DATA =
      (SERVER = DEDICATED)
      (SERVICE_NAME = nldap.acme.com)
    )
  )
```

9. Create an archive of all the data files and compress the archived file. Be sure to include all the files listed under `DATAFILE` in `newdb.sql`.

As an example, you could use the following commands to go to the database file location and generate a compressed archive called `OID_DB.tar.Z`:

```
$ cd $ORACLE_BASE/oradata/$ORACLE_SID
$ tar -cvf OID_db.tar *.dbf
$ compress OID_db.tar
```

10. Install Oracle Database on the new node using the software only option. See the *Oracle Database Installation Guide* for your platform and *Oracle Fusion Middleware Installation Guide for Oracle Identity Management*.
11. When the software-Only install on the new node has completed, the following directory exists:

```
/private1/oracle/app/oracle/product/OraHome_1/diag/rdbms
```

Create the following directories on the new node:

- Datafile location: `/private1/oracle/app/oracle/oradata/NLDAP`
- Dump destinations:
 - `/private1/oracle/app/oracle/admin/NLDAP/adump`
 - `/private1/oracle/app/oracle/admin/NLDAP/udump`

```
/private1/oracle/app/oracle/flash_recovery_area
```

- Trace file location: /private1/oracle/app/oracle/product/OraHome_1/diag/rdbms/nldap/nldap/trace

12. Copy the archived file created on the sponsor node in Step 9 to the new node, using FTP or another appropriate tool. Change directory to the database file location on the new node, then use FTP to copy the archived file from rst-sun.

```
$ cd /private1/oracle/app/oracle/oradata/NLDAP
$ ftp
ftp> open rst-sun
Connected to rst-sun.us.example.com.
220 rst-sun FTP server (UNIX(r) System V Release 4.0) ready.
Name (rst-sun:oracle):
331 Password required for oracle.
Password:
230 User oracle logged in.
ftp> cd /private/oracle/oradata/LDAP
250 CWD command successful.
ftp> binary
200 Type set to I.
ftp> mget oradb.tar.Z
```

If the data files are very large (several gigabytes or terabytes) and the network bandwidth is low, consider using media, such as tape or disk, to move the compressed file from the sponsor to the new node.

Extract the archived file on the new node. For example:

```
$ uncompress oradb.tar.Z
$ tar xvf oradb.tar
```

Ensure that the data files are extracted to the correct directory. In our example, it is /private1/oracle/oradata/NLDAP

13. If the sponsor node is part of an Advanced replication group, then perform the following steps:
 - a. Copy the initialization parameter file `initLDAP.ora` from the sponsor node (rst-sun) to the new node under the UNIX directory `$ORACLE_HOME/dbs` using a tool such as FTP. Rename the file to `initNLDAP.ora`.

Ensure that the contents of the copied file `initLDAP.ora` are valid after copying.

Edit the file `initLDAP.ora`. Change:

```
.db_name='NLDAP'
```

to

```
.db_name='LDAP'
```

- b. Using a tool such as FTP, copy the file `newdb.sql` you created on the sponsor node in Step 5 to the new node. Rename `newdb.sql` to `olddb.sql`.

Edit `olddb.sql`. Change:

```
CREATE CONTROLFILE REUSE SET DATABASE "NLDAP" RESETLOGS NOARCHIVELOG
```

to:

```
CREATE CONTROLFILE REUSE SET DATABASE "LDAP" RESETLOGS NOARCHIVELOG
```

- c. Make a copy of `tnsnames.ora` called `tnsnames.ora.bk`.

Edit `tnsnames.ora`. Change:

```
LDAP.ACME.COM =
  (DESCRIPTION =
    (ADDRESS = (PROTOCOL = TCP)(HOST = rst-sun)(PORT = 1521))
    (CONNECT_DATA =
      (SERVER = DEDICATED)
      (SERVICE_NAME = ldap.acme.com)
    )
  )
)
NLDAP.ACME.COM =
  (DESCRIPTION =
    (ADDRESS = (PROTOCOL = TCP)(HOST = dsm-sun)(PORT = 1521))
    (CONNECT_DATA =
      (SERVER = DEDICATED)
      (SERVICE_NAME = nldap.acme.com)
    )
  )
)
```

to:

```
LDAP.ACME.COM =
  (DESCRIPTION =
    (ADDRESS = (PROTOCOL = TCP)(HOST = dsm-sun)(PORT = 1521))
    (CONNECT_DATA =
      (SERVER = DEDICATED)
      (SERVICE_NAME = ldap.acme.com)
    )
  )
)
```

- d. At the shell prompt on the new node, set the `ORACLE_BASE`, `ORACLE_HOME`, and `ORACLE_SID` environment variables. For example (using the C shell):

```
$ setenv ORACLE_BASE /private1/oracle/app/oracle
$ setenv ORACLE_HOME /private1/oracle/app/oracle/product/OraHome_1
$ setenv ORACLE_SID LDAP
```

- e. In the same shell, execute `olddb.sql` using SQL*Plus as shown in the following example:

```
cd /private1/oracle/app/oracle/admin/NLDAP/udump
$ sqlplus /nolog
SQL> connect / as sysdba
SQL> @olddb.sql
SQL> shutdown normal
SQL> exit
```

- f. Start up the database and listener as follows:

```
$ sqlplus /nolog
SQL> connect / as sysdba
SQL> startup mount
SQL> alter database open resetlogs
SQL> exit
$ lsnrctl start
```

- g. If you have performed a database copy from a node that has Advanced replication configured with another node, you must delete the `LDAP_REP` replication group in the new node. To do so, execute the following commands:

```
sqlplus / as sydba
```

```

SQL> dbms_defer_sys.delete_tran(null,null);
SQL> dbms_defer_sys.delete_error(null,null);
SQL> dbms_repcat.purge_master_log(null,null,null);
SQL> exit

sqlplus rep_admin_db_account_name/password
SQL> exec dbms_repcat.drop_master_repgroup( gname => 'LDAP_REP' )
SQL> shutdown immediate

```

14. Copy the initialization parameter file `initLDAP.ora` from the sponsor node (rst-sun) to the new node under the UNIX directory `$ORACLE_HOME/dbs` using FTP or another appropriate tool. Ensure that the contents of the copied file `initLDAP.ora` are valid after copying.

In addition, also copy the database password file `orclpwORACLE_SID` from the sponsor node to the new node.

15. On the new node, ensure that the following files do not exist in the directory `$ORACLE_HOME/dbs` on UNIX or `ORACLE_HOME\database` in Windows:
 - `spfileNLDAP.ora`
 - `spfile.ora`

If either of these files exists, the Oracle database uses that file instead of the `initNLDAP.ora` file you copied from the sponsor node.

16. Using FTP or another appropriate tool, copy the file `newdb.sql` you created on the sponsor node in Step 5 to the new node. For example:

```

$ cd /private1/oracle/app/oracle/admin/NLDAP/udump
$ ftp
ftp> open rst-sun
ftp> cd /private1/oracle/app/oracle/admin/LDAP/udump
ftp> mget newdb.sql

```

17. At the UNIX shell prompt on the new node, set `ORACLE_BASE`, `ORACLE_HOME` and `ORACLE_SID` environment variables. For example (using the C shell):

```

$ setenv ORACLE_BASE /private1/oracle/app/oracle
$ setenv ORACLE_HOME /private1/oracle/app/oracle/product/OraHome_1
$ setenv ORACLE_SID NLDAP

```

18. In the same UNIX shell, execute `newdb.sql` using SQL*Plus as shown in the following example:

```

$ sqlplus /nolog
SQL> connect / as sysdba
SQL> @newdb.sql
SQL> shutdown normal
SQL> exit

```

19. Complete the changes on the new node.

- a. Start up the database and listener as follows:

```

$ sqlplus /nolog
SQL> connect / as sysdba
SQL> startup mount
SQL> alter database open resetlogs
SQL> exit
$ lsnrctl start

```

- b. Change the global database name of the new node.

```
SQL> connect / as sysdba
SQL> alter database rename global_name to NLDAP;
SQL> exit
```

Note that the new node ORACLE_SID IS NLDAP.

- c. Add a temporary file to the tablespace using the following command:

```
SQL> connect / as sysdba
SQL> ALTER TABLESPACE TEMP ADD TEMPFILE 'temp01.dbf' size 2000k;
SQL> exit
```

The value 2000K is just an example. Determine your own value based on the requirements of your environment.

20. Configure Oracle Internet Directory on the new node

- a. Install WebLogic Server. See *Oracle Fusion Middleware Installation Guide for Oracle WebLogic Server*.
- b. Install Oracle Internet Directory. See *Oracle Fusion Middleware Installation Guide for Oracle Identity Management*.

Note: When you configure Oracle Internet Directory on the new node, you must specify the information for the new node database (created in Step 10).

- c. Stop Oracle Internet Directory by using `opmnctl`.

21. On the new node, delete the wallet files `oidpwdlldap1` and `oidpwdr*` at the new node and reset the ODS password

```
$ cd $ORACLE_HOME/OID/admin
$ rm oidpwdlldap1 oidpwdr*
```

22. On the new node, reset the password and start the Oracle Internet Directory processes.

```
oidpasswd connect=nldap create_wallet=true
```

you are prompted to provide the current database password, enter a new database password, and confirm the new password.

Start Oracle Internet Directory on the new node by using the `opmnctl` command.

```
$opmnctl startproc ias-component=oid1
```

23. At this point, Oracle Internet Directory on the new node is up and running. The `replicaid` value in new Oracle Internet Directory node, however, still has the replica id of the sponsor's node. Therefore, you must reset new node's `replicaid`. The new value of `replicaid` must be of the form `hostname_sid` where:

- `hostname` is the host name of the new node, without the domain name
- `sid` is the ORACLE_SID of the new node database

Ensure that all letters of the `replicaid` are in lower case.

- a. Create a file, `chgrid.ldif`, with the following contents:

```
dn:
```

```
changetype: modify
replace: orclreplicaid
orclreplicaid: new_replicaid
```

b. Using the ldapmodify tool, change the replicaid:

```
$ORACLE_HOME/bin/ldapmodify -h new_node_host -p port_ldap_server -f
chgrid.ldif
```

24. Because the replica id of the new node was changed in Step 23, you must re-create the relative replica entries for the new node, as follows:

```
$ remtool -pcleanup -bind "new_node_host:new_node_port/new_node_repl_pswd"
```

The `remtool` command does report an error and prompt for input because there are no replica entries that correspond with the new replica id yet. The `remtool` command uses your responses to rectify the error. Here is an example, with user input shown in boldface:

```
remtool -pcleanup -bind "new_node_host:new_node_port/new_node_repl_pswd"
Error occurred while getting replication configuration information.
This tool will try to rectify the problem if super user DN and password are
provided.
Do you want to continue? [y/n] : y
Enter superuser DN : cn=orcladmin
Enter superuser password :
Enter new password of replication DN :
Reenter new password of replication DN :
DRG identified by replica ldap://new_node_host:new_node_port (new_replicaid)
will be cleaned up.
Do you want to continue? [y/n] : y
-----
Replica replica ldap://new_node_host:new_node_port (new_replicaid) has been
cleaned up.
```

25.) In addition to renaming the replica subentry, you must change the `orclreplicauri`, `orclreplicasecondaryuri` and `orclreplicastate` attributes of the replica subentry. You must modify the `orclreplicauri` and `orclreplicasecondaryuri` attributes to contain the URI of the new node's LDAP server. You must set the `orclreplicastate` attribute must be set to 6, which specifies to `remtool` that this a database copy-based addnode. To change the values, proceed as follows.

a. Create an LDIF file, `modsubentry.ldif`, with the following contents:

```
dn: orclreplicaid=new_replicaid,cn=replication configuration
changetype: modify
replace: orclreplicauri
# Use your host name and port number
# where ldap server is listening
orclreplicauri: ldap://new_node_host:new_node_port/
---
replace:orclreplicasecondaryuri
# Use your fully qualified host name and
# the port number where ldap server is listening
orclreplicasecondaryuri:
ldap://new_node_host_with_domain_name:new_node_port/
----
replace:orclreplicastate
orclreplicastate: 6
```

- b. Using the `ldapmodify` tool, apply the changes to the directory:

```
$ ldapmodify -h new_node_host -p port_of_ldap_server -f modsubentry.ldif
```

26. Stop Oracle Internet Directory processes.

```
$opmnctl stopproc ias-component=oid1
```

27. Clean up the changelog tables at the new node.

```
$ sqlplus /nolog
SQL> connect ods/ods_password;
SQL> truncate table ods.ods_chg_log;
SQL> truncate table ods.ods_chg_stat;
SQL> truncate table ods.asr_chg_log;
```

28. If the new node is part of an Advanced Replication-based DRG, proceed as follows.

- a. To configure Oracle Database Advanced Replication, if you are adding new node to an existing DRG, at the shell prompt, execute the following command:

```
$ remtool -addnode
```

To configure Oracle Database Advanced Replication, if you are creating a new DRG consisting of sponsor node and new node, at the shell prompt, execute the following command:

```
$ remtool -asrsetup
```

- b. Start up Oracle Internet Directory and the replication server on all the nodes, including the new node and the sponsor node.

Use the following command to start replication server:

```
oidctl connect=nldap server=OIDREPLD instance=1 \
  flags="-p new_node_port -h new_node_host" start
```

Then execute `resumeasr` or `oidrrsme.sql`.

29. If the new node is a full LDAP-based replication replica, configure LDAP-based Replication and add the full replica as fan-out, as follows:

- a. Make sure that the database and Oracle Internet Directory server is running at the sponsor node.

On the sponsor node, type:

```
$ sqlplus /nolog
SQL> connect / as sysdba
SQL> startup
SQL> exit
$ lsnrctl start
Start OID
$opmnctl startproc ias-component=oid1
```

Check the status of Oracle Internet Directory by typing:

```
$opmnctl status
```

- b. Configure LDAP-based replication using `remtool`, as follows:

```
remtool -paddnode
```

c. Initialize the replication change status of the new replication agreement.

- Get the maximum used change number from the sponsor node:

```
$ ldapsearch -h sponsor_node_host -p sponsor_node_port -b " " \
-s base "objectclass=*" lastchangenumber
```

- Create an LDIF file `chgstatus.ldif`, with the following contents:

```
dn: orclagreementid=new_agreement_id,orclreplicaid=new_
replicaid,cn=replication configuration
changetype: modify
replace: orcllastappliedchangenumber;transport$sponsor_replicaid$new_
replicaid
orcllastappliedchangenumber;transport$sponsor_replicaid$new_replicaid:
Number_from_ldapsearch
-
replace: orcllastappliedchangenumber;apply$sponsor_replicaid$new_
replicaid
orcllastappliedchangenumber;apply$sponsor_replicaid$new_replicaid:
Number_from_ldapsearch
```

where *Number_from_ldapsearch* refers to the maximum change number from the sponsor node that you obtained using the `ldapsearch` command.

- Using `ldapmodify`, apply the change to both the sponsor node and the new node:

```
ldapmodify -p sponsor_node_port -h sponsor_node_host -v \
-f chgstatus.ldif
ldapmodify -p new_node_port -h new_node_host -v -f chgstatus.ldif
```

d. Start up Oracle Internet Directory and the replication server on all the nodes. For one-way replication, you only need to start the replication server on the consumer node.

Oracle Authentication Services for Operating Systems

Oracle Authentication Services for Operating Systems was introduced in Oracle Internet Directory 10g (10.1.4.0.1). It has been updated for 11g Release 1 (11.1.1). Oracle Authentication Services for Operating Systems enables you to centralize storage, authentication, and management of user identities using Oracle Internet Directory. See *Oracle Fusion Middleware Administrator's Guide for Oracle Authentication Services for Operating Systems* for more information.



RFCs Supported by Oracle Internet Directory

[Table N-1](#) contains a list of the RFCs currently supported by Oracle Internet Directory. Some of these have been obsoleted or updated by newer RFCs. Oracle Internet Directory is continuously being updated to ensure that it conforms to the newer documents.

Table N-1 Supported RFCs

Number	Title
RFC 1274	The COSINE and Internet X.500 Schema
RFC 1488	The X.500 String Representation of Standard Attribute Syntaxes
RFC 1777	Lightweight Directory Access Protocol
RFC 1778	The String Representation of Standard Attribute Syntaxes
RFC 1779	A String Representation of Distinguished Names
RFC 1960	A String Representation of LDAP Search Filters
RFC 2079	Definition of an X.500 Attribute Type and an Object Class to Hold Uniform Resource Identifiers (URIs)
RFC 2247	Using Domains in LDAP/X.500 Distinguished Names
RFC 2251	Lightweight Directory Access Protocol (v3)
RFC 2252	Lightweight Directory Access Protocol (v3) Attribute Syntax Definitions
RFC 2253	Lightweight Directory Access Protocol (v3) UTF-8 String Representation of Distinguished Names
RFC 2254	The String Representation of LDAP Search Filters
RFC 2255	The LDAP URL Format
RFC 2256	A summary of the X500 (96) User Schema for use with LDAPv3
RFC 2307	An Approach for Using LDAP as a Network Information Service
RFC 2377	Naming Plan for Internet Directory-Enabled Applications
RFC 2396	Uniform Resource Identifiers (URI): Generic Syntax
RFC 2596	Use of Language Codes in LDAP
RFC 2696	LDAP Control Extension for Simple Paged Results Manipulation
RFC 2713	Schema for Representing Java(tm) Objects in an LDAP Directory
RFC 2798	Definition of the inetOrgPerson LDAP Object Class

Table N-1 (Cont.) Supported RFCs

Number	Title
RFC 2829	Authentication Methods for LDAP
RFC 2830	Lightweight Directory Access Protocol (v3): Extension for Transport Layer Security
RFC 2849	The LDAP Data Interchange Format (LDIF) - Technical Specification
RFC 2891	LDAP Control Extension for Server Side Sorting of Search Results
RFC 3112	LDAP Authentication Password Schema
RFC 3296	Named Subordinate References in Lightweight Directory Access Protocol (LDAP) Directories
RFC 3377	Core LDAP Requirements
RFC 3671	Collective Attributes in the Lightweight Directory Access Protocol (LDAP)
RFC 3673	Search results returning all operational attributes
RFC 4122	Universally Unique Identifier (UUID) URN Namespace
RFC 4514	String Representation of Distinguished Names

Oracle Internet Directory's base schema is continually revised to comply with new RFC revisions.

See Also: The Internet Engineering Task Force home page at <http://www.ietf.org/>.



Managing Oracle Directory Services Manager's Java Key Store

ODSM stores its private key, certificate and trusted certificates in a Java Key Store (JKS). As administrator, you are responsible for managing ODSM's JKS. One important task you must perform is to remove ODSM's certificates from the JKS when they have expired. This appendix explains how.

This appendix contains the following topics:

- [Introduction to Managing ODSM's Java Key Store](#)
- [Retrieving ODSM's Java Key Store Password](#)
- [Listing the Contents of odsm.cer Java Key Store](#)
- [Deleting Expired Certificates](#)

Introduction to Managing ODSM's Java Key Store

The first time ODSM is invoked, it generates a random password and assigns the password to its JKS. The JKS file has the name `odsm.cer`. The file resides in a directory with a name of the form:

```
DOMAIN_HOME/config/fmwconfig/servers/AdminServer/applications/odsm/conf
```

ODSM stores the password to its JDK in Credential Store Framework (CSF), a secure storage framework provided by Oracle. The WebLogic server administrator can retrieve the JDK password stored in CSF.

ODSM also generates a self-signed certificate for itself and stores it in its JKS. This self-signed certificate is valid for 15000 days from the date of generation. This self-signed certificate is intended for testing purposes only. Oracle recommends replacing this self-signed certificate with a certificate signed by a Certificate Authority (CA) for production purposes.

There is no web-based tool for managing a JKS. To manage ODSM's JKS, you use `keytool`, a command-line tool shipped with the Sun JRE/JDK. To get the JKS password from CSF, you use the `wlst listCred` command.

See Also:

- The chapter on configuring the credential store in *Oracle Fusion Middleware Application Security Guide* for more information about CSF.
- Java™ Cryptography Architecture API Specification & Reference, at <http://java.sun.com>
- keytool - Key and Certificate Management Tool, at <http://java.sun.com>

Retrieving ODSM's Java Key Store Password

To manage ODSM's JKS, you must first retrieve ODSM's JKS password from CFS. The WebLogic administrator can retrieve it using the `wlst` command, as follows:

```
$ORACLE_HOME/common/bin/wlst.sh
Initializing WebLogic Scripting Tool (WLST) ...

Welcome to WebLogic Server Administration Scripting Shell

Type help() for help on available commands

wls:/offline> connect()
Please enter your username [weblogic] :weblogic
@ Please enter your password [weblogic] :
Please enter your server URL [t3://localhost:7001] :t3://stadd54:7001
Connecting to t3://stadd54:7001 with userid weblogic ...
Successfully connected to Admin Server 'AdminServer' that belongs to domain
'base_domain'.

Warning: An insecure protocol was used to connect to the
server. To ensure on-the-wire security, the SSL port or
Admin port should be used instead.

wls:/base_domain/serverConfig> listCred( map="ODSMMap", key="ODSMKey.Wallet"
)
{map=ODSMMap, key=ODSMKey.Wallet}
Location changed to domainRuntime tree. This is a read-only tree with
DomainMBean as the root.
For more help, use help(domainRuntime)

[Name : ODSM, Description : null, expiry Date : null]
@ PASSWORD:_AQ-\<x<92
```

See Also: "Managing the Credential Store" in *Oracle Fusion Middleware Application Security Guide* for more information about managing credentials with `wlst` commands.

Listing the Contents of `odsm.cer` Java Key Store

After you retrieve the JKS password, you can manage the JKS by using `keytool`.

To list the contents of `odsm.cer`, use the `keytool` command, as follows:

```
cd directory_where_odsm.cer_resides
JAVA_HOME/bin/keytool -list -keystore odsm.cer \
-storepass password_obtained_from_CSF
```

For example:

```
$ cd DOMAIN_HOME/config/fmwconfig/servers/AdminServer/applications/odsm/conf
$ JAVA_HOME/bin/keytool -list -keystore odsm.cer -storepass "&M)S86)/RB" -v
```

```
Keystore type: JKS
Keystore provider: SUN
```

Your keystore contains 2 entries

```
Alias name: serverselfsigned
Creation date: Dec 26, 2008
Entry type: PrivateKeyEntry
Certificate chain length: 1
Certificate[1]:
Owner: CN=OVD, OU=Development, O=Oracle, L=Redwood Shores, ST=California, C=US
Issuer: CN=OVD, OU=Development, O=Oracle, L=Redwood Shores, ST=California, C=US
Serial number: 495586b6
Valid from: Fri Dec 26 17:36:54 PST 2008 until: Wed Jun 24 18:36:54 PDT 2009
Certificate fingerprints:
    MD5: 6C:11:16:F3:88:8D:18:67:35:1E:16:5B:3E:03:8A:93
    SHA1: F4:91:39:AE:8B:AC:46:B8:5D:CB:D9:A4:65:BE:D2:75:08:17:DF:D0
Signature algorithm name: SHA1withRSA
Version: 3
```

```
*****
*****
```

```
Alias name: cn=rootca, o=oracle, c=us (0)
Creation date: Dec 31, 2008
Entry type: trustedCertEntry

Owner: CN=RootCA, O=Oracle, C=US
Issuer: CN=RootCA, O=Oracle, C=US
Serial number: 0
Valid from: Tue Dec 30 02:33:11 PST 2008 until: Mon Jan 24 02:33:11 PST 2050
Certificate fingerprints:
    MD5: 72:31:7B:24:C9:72:E3:90:37:38:68:40:79:D1:0B:4B
    SHA1: D2:17:84:1E:19:23:02:05:61:42:A9:F4:16:C8:93:84:E8:20:02:FF
Signature algorithm name: MD5withRSA
Version: 1
```

```
*****
*****
```

Deleting Expired Certificates

There is no automatic mechanism for removing certificates from the JDK when they expire. As administrator, you must determine when a certificate has expired and remove it.

This section contains the following topics:

- ["Determining the Expiration Date of a Certificate"](#) on page O-4
- ["Deleting a Certificate"](#) on page O-4

Determining the Expiration Date of a Certificate

As explained in "[Listing the Contents of odsm.cer Java Key Store](#)" on page O-2, you list all certificates in `odsm.cer` by using `keytool`. The listing contains the valid dates for each certificate. For example, the following certificate is valid until Sat Oct 31 09:41:23 PDT 2008:

```
Alias name: cn=ovd, ou=development, o=MyCompany, l=redwood shores,
st=california, c=us (1241455283)
Creation date: May 5, 2008
Entry type: trustedCertEntry

Owner: CN=OVD, OU=Development, O=MyCompany, L=Redwood Shores, ST=California,
C=US
Issuer: CN=OVD, OU=Development, O=Oracle, L=Redwood Shores, ST=California,
C=US
Serial number: 49ff1ab3
Valid from: Mon May 04 09:41:23 PDT 2008 until: Sat Oct 31 09:41:23 PDT 2008
Certificate fingerprints:
MD5: 93:0E:41:5E:95:88:71:BD:8A:49:ED:A9:29:3B:0A:1E
SHA1: 84:C6:75:60:D9:BE:7B:CA:D6:8B:B5:4B:97:E4:20:39:44:82:FE:93
Signature algorithm name: SHA1withRSA
Version: 3
```

If certificate's validity period has expired, delete it using `keytool` as explained in the next section.

Deleting a Certificate

To delete a certificate in `odsm.cer`, use `keytool`, as follows:

```
cd directory_where_odsm.cer_is_present
JAVA_HOME/bin/keytool -delete -keystore odsm.cer
-storepass password_obtained_from_CSF -alias "cn=rootca, o=oracle, c=us (0)"
```

For example

```
$> JAVA_HOME/bin/keytool -delete -keystore odsm.cer \
-storepass "&M)S86)/RB" -alias "cn=rootca, o=oracle, c=us (0)"
[Storing odsm.cer]
```

Starting and Stopping the Oracle Stack

You must start and stop the components of the Oracle stack in a specific order, which is described in this appendix.

Starting the Stack

Start the stack components in the following order.

1. Start the Oracle Database
 - a. In the Database `ORACLE_HOME`, set the `ORACLE_SID`, `ORACLE_HOME` and `PATH` environment variables to the appropriate values.
 - b. Start the listener.

```
ORACLE_HOME/bin/lsnrctl start
```

- c. Start the database.

```
ORACLE_HOME/bin/sqlplus "/as sysdba"  
startup
```

2. Start the Oracle WebLogic Administration Server.

Note: If you start the Oracle WebLogic Administration Server from the command line as shown, it runs in the foreground and prints output to the screen. You can, however, run the server in the background by using `nohup` at the beginning of the command line. This sends all output to the file `nohup.out` and prevents the script from prompting you for `USER_NAME` and `PASSWORD`. To pass parameters to `StartWebLogic.sh` when using `nohup`, you can use a boot identity file, as described in the "Starting and Stopping Servers" chapter of *Oracle Fusion Middleware Managing Server Startup and Shutdown for Oracle WebLogic Server*.

```
MW_HOME/user_projects/domains/DOMAIN_NAME/bin/startManagedWebLogic.sh \  
SERVER_NAME {ADMIN_URL}
```

When executing these scripts:

- The default value for `DOMAIN_NAME` is `IDMDomain`
- `SERVER_NAME` represents the name of the Oracle WebLogic Managed Server. Its default value is `wls_ods1`.

- You will be prompted for values for `USER_NAME` and `PASSWORD` if you do not provide them as options when you execute the script.
 - The value for `ADMIN_URL` will be inherited if you do not provide it as an option when you execute the script.
3. Ensure that the Node Manager is running. Normally, the Oracle WebLogic Administration Server starts the Node Manager. If, for some reason, the Node Manager is not running, start it.

```
MW_HOME/user_projects/domains/DOMAIN_NAME/bin/startNodeManager.sh
```

4. Start system components, such as Oracle Internet Directory and Oracle Virtual Directory.

```
ORACLE_INSTANCE/bin/opmnctl startall
```

You can verify that the system components have started by executing:

```
ORACLE_INSTANCE/bin/opmnctl status -l
```

5. Start WebLogic managed components, such as Oracle Directory Integration Platform and Oracle Directory Services Manager.

```
MW_HOME/user_projects/domains/DOMAIN_NAME/bin/startManagedWebLogic.sh \  
SERVER_NAME {ADMIN_URL}
```

To start managed components in the background, you can use the Oracle WebLogic Administration Console. See *Oracle Fusion Middleware Introduction to Oracle WebLogic Server* for more information.

You can view the status of WebLogic managed components with Oracle Enterprise Manager Fusion Middleware Control. See ["Using Fusion Middleware Control to Manage Oracle Internet Directory"](#) on page 7-4.

Stopping the Stack

You can stop the Administration Server and all the managed servers by using Oracle WebLogic Administration Console. See *Oracle Fusion Middleware Introduction to Oracle WebLogic Server* for more information.

To stop the stack components from the command line, issue the commands in the following order.

1. Stop WebLogic managed components, such as Oracle Directory Integration Platform and Oracle Directory Services Manager.

```
MW_HOME/user_projects/domains/DOMAIN_NAME/bin/stopManagedWebLogic.sh \  
{SERVER_NAME} {ADMIN_URL} {USER_NAME} {PASSWORD}
```

2. Stop system components, such as Oracle Internet Directory and Oracle Virtual Directory.

```
ORACLE_INSTANCE/bin/opmnctl stopall
```

3. Stop the WebLogic Administration Server.

```
MW_HOME/user_projects/domains/DOMAIN_NAME/bin/stopWebLogic.sh
```

4. If you want to stop the Node Manager, you can use the `kill` command.

```
kill -9 pid
```

5. Stop the Oracle Database.

- a.** In the Database `ORACLE_HOME`, set the `ORACLE_SID`, `ORACLE_HOME`, and `PATH` environment variables to the appropriate values.

- b.** Stop the database.

```
ORACLE_HOME/bin/sqlplus "/as sysdba"  
shutdown immediate
```

- c.** Stop the listener.

```
ORACLE_HOME/bin/lsnrctl stop
```

Performing a Rolling Upgrade

If replication is configured in your Oracle Internet Directory environment, follow the procedure in this appendix to perform a rolling upgrade. This appendix contains references to *Oracle Fusion Middleware Patching Guide*.

In order to upgrade your Oracle home directories in a Directory Replication Group (DRG), you must shut down all the replication servers in the DRG and upgrade each Oracle home to the latest version individually. If you do not shut down the replication servers, you might encounter issues when upgrading the Middleware Oracle home directories. To avoid the downtime and loss of service associated with this process, Oracle recommends following a rolling upgrade procedure, where each Oracle home directory is upgraded individually while the other Oracle Internet Directory nodes and the corresponding replication servers in the DRG remain up and running.

Prerequisites for Rolling Upgrade

Depending on your DRG version, you must apply the following one-off patches to each Oracle home in the DRG before starting the rolling upgrade procedure to upgrade the `remtool` and `oidrepld` binaries:

- If you have Oracle Internet Directory Version 11.1.1.2.0, apply the fix for bug number 10033740 on each Middleware Oracle home.
- If you have Oracle Internet Directory Version 11.1.1.3.0, apply the fix for bug number 10033746 on each Middleware Oracle home.

Rolling Upgrade Instructions

Follow the instructions in this section to upgrade an Oracle Internet Directory DRG:

1. Stop the replication server on the first node you want to upgrade.
2. Suspend the replication from the first node to each of the other nodes:

```
remtool -psuspendrepl -fromnode first_node_host:first_node_port
```

This command lists out the replica IDs of all the Oracle Internet Directory nodes along with their respective directory version numbers. You must either specify the replica ID of each of the other nodes as prompted or enter `all` which suspends replication to all the other nodes..

See "remtool" in *Oracle Fusion Middleware Reference for Oracle Identity Management* for more information.

3. Validate that replication has been suspended from the first node to all the other nodes in the DRG by running the following `ldapsearch` command:

```
ldapsearch -h first_node_host -p OID_port -b "" -s base
"(objectclass=orclReplAgreementEntry)" orcllastappliedchangenumber
```

Look for `orcllastappliedchangenumber` from the first node to the other nodes with subtype status. It should have value 0. It will be of the form:

```
orcllastappliedchangenumber;status$replica_id_of_first_node$replica_id_of_
other_node;transport
```

and

```
orcllastappliedchangenumber;apply;status$replica_id_of_first_node$replica_id_
of_other_node
```

If there are any discrepancies, you should repeat Step 2.

4. Stop Oracle Internet Directory on the node you are about to upgrade.
5. Patch the node to Release 11.1.1.4.0. Refer to the instructions in the *Oracle Fusion Middleware Patching Guide*:
6. Start Oracle Internet Directory on the node you have just upgraded.
7. Because no other nodes have been upgraded yet, do not resume replication between the first node and any other node.
8. Stop the replication server on the second node you want to upgrade.
9. Suspend replication from the second node to each of the nodes that have not been upgraded.

```
remtool -psuspendrepl -fromnode second_node_host:second_node_port
```

This command lists out the replica IDs of all the Oracle Internet Directory nodes along with their respective directory version numbers. You must specify the replica ID of each of the other nodes that have not been upgraded.

10. Validate that replication has been suspended from the node you are about to upgrade to each node that has not been upgraded, using the same command as in Step 3 against the second node.
11. Stop Oracle Internet Directory on the node you are about to upgrade.
12. Patch the node to Release 11.1.1.4.0 as in Step 5.
13. Start Oracle Internet Directory on the node you have just upgraded.
14. Now two nodes have been upgraded, so resume replication from the first node you upgraded to the second node you upgraded.

```
remtool -presumerepl -fromnode first_upgraded_replica_host:port -tonode
second_upgraded_replica_host:port
```

15. Validate that replication has been resumed from first upgraded node to the second upgraded nodes in DRG by running the following `ldapsearch` command:

```
ldapsearch -p OID_port -h first_upgraded_OID_host -b "" -s base "(objectclass=
orclReplAgreementEntry)" orcllastappliedchangenumber
```

Look for `orcllastappliedchangenumber` from the first upgraded Oracle Internet Directory node to the second upgraded node with subtype status; it should have a value of 1.

Repeat this `ldapsearch` command against all other earlier upgraded nodes. If there are any discrepancies, repeat Step 14.

16. Start replication server on the second upgraded replica.
17. Shut down the replication server on the third node you want to upgrade.
18. Suspend replication from the third node to each node that has not yet been upgraded, if any.
19. Validate that replication has been suspended from the third node to each node that has not been upgraded.
20. Stop Oracle Internet Directory and other processes on the third node to be upgraded.
21. Patch the node to Release 11.1.1.4.0 as in Step 5.
22. Start Oracle Internet Directory on the third node.
23. Resume replication from each node that has already been upgraded to the third node.
24. Validate that replication has been resumed from each upgraded node to the third node.
25. Start replication on the third node

Repeat this procedure for all the nodes. Before upgrading a node, suspend replication from that node to each of the nodes that has not yet been upgraded and validate that it is suspended. Stop Oracle Internet Directory on the node you are about to upgrade. Upgrade the node. Start Oracle Internet Directory on the node you just upgraded. Resume replication from nodes that are already upgraded to the node you just upgraded. Start replication on the node you just upgraded.

Rolling Upgrade Example

In this example, there are three Oracle Internet Directory nodes, A, B, and C, in a multimaster DRG. All of them are running 11g Release 1 (11.1.1.3.0). They need to be upgraded to 11g Release 1 (11.1.1.4.0) by using the rolling upgrade procedure.

We will upgrade Node A first, followed by B and C.

Before starting the rolling upgrade procedure, apply the patch for 11g Release 1 (11.1.1.3.0) on all nodes to patch the `oidrepld` and `remtool` binaries. See ["Prerequisites for Rolling Upgrade"](#) on page Q-1.

Follow these steps to upgrade the nodes:

1. Stop the replication server on Node A.
2. Suspend the replication from:
 - Node A to OID Node B
 - Node A to OID Node C

```
remtool -psuspendrepl -fromnode HostA:PortA
```

This command displays the replica IDs of all three Oracle Internet Directory nodes. Provide the replica IDs of Node B and Node C as input to `remtool`. Alternatively, you can enter `all`, which causes `remtool` to automatically select the replica IDs of B and C.

3. Validate that replication has been suspended from Node A to Node B by running the following `ldapsearch` command:

```
ldapsearch -p PortA -h hostA -b "" -s base
```

```
"(objectclass=orclReplAgreementEntry)" orcllastappliedchangenumber
```

Look for `orcllastappliedchangenumber` with subtype `status`. It has value 0 and is of the form:

```
orcllastappliedchangenumber;apply;status$replica_id_of_node_A$replica_id_of_node_B
orcllastappliedchangenumber:status$replicaid_of_node_A$replicaid_of_node_B;transport
```

If there is any discrepancy in the status value, repeat Step 2.

Similarly, validate that replication has been suspended from Node A to Node C.

4. Stop Oracle Internet Directory and other processes on Node A.
5. Run the PSA on Node A to upgrade it to 11g Release 1 (11.1.1.4.0).
6. Bring up Oracle Internet Directory and the replication server on Node A. Note that there is no node with which Node A should resume replication.
7. Stop the replication server on Node B.
8. Suspend replication from Node B to Node C by executing the following command:

```
remtool -psuspendrepl -fromnode HostB:PortB -tonode HostC:PortC
```

9. Validate that replication has been suspended from Node B to Node C by running the following `ldapsearch` command:

```
ldapsearch -p PortB -h hostB -b "" -s base
"(objectclass=orclReplAgreementEntry)" orcllastappliedchangenumber
```

Look for `orcllastappliedchangenumber` with subtype `status`. It has value 0 and is of the form:

```
orcllastappliedchangenumber;apply;status$replica_id_of_node_B$replica_id_of_node_C
orcllastappliedchangenumber:status$replicaid_of_node_B$replicaid_of_node_C;transport
```

If there is any discrepancy in the status value, repeat Step 8.

10. Stop Oracle Internet Directory and other processes on Node B.
11. Run the PSA on Node B to upgrade it to 11g Release 1 (11.1.1.4.0).
12. Bring up Oracle Internet Directory on Node B.

Resume replication from Node A to Node B

```
remtool -presumerepl -fromnode HostA:PortA -tonode HostB:PortB
```

13. Validate that replication has been resumed from Node A to Node B by running the following `ldapsearch` command:

```
ldapsearch -p OID_port -h hostA -b "" -s base "(objectclass=orclReplAgreementEntry)" orcllastappliedchangenumber
```

Look for `orcllastappliedchangenumber` from the upgraded Node A to Node B with subtype `status`. It should have value 1.

If there is any discrepancy in the status value, repeat Step 12.

14. Bring up the replication server on Node B.
15. Shut down the replication server on Node C.

16. There is no other node to be upgraded so there is no need to suspend replication. Stop Oracle Internet Directory and other processes on Node C.

17. Run PSA on Node C to upgrade it to 11g Release 1 (11.1.1.4.0).

18. Bring up Oracle Internet Directory on Node C.

Resume replication from Node A to Node C.

```
remtool -presumerepl -fromnode HostA:PortA -tonode HostC:PortC
```

Resume replication from Node B to Node C.

```
remtool -presumerepl -fromnode HostB:PortB -tonode HostC:PortC
```

19. Validate that replication has been resumed successfully by performing an `ldapsearch` on Node A and Node B similar to Step 13. Validate replication:

- From Node A to Node C
- From Node B to Node C

20. Bring up the replication server on Node C.

Troubleshooting Oracle Internet Directory

This appendix explains typical problems that you could encounter while running or installing Oracle Internet Directory. It contains these sections:

- [Problems and Solutions](#)
- [Need More Help?](#)

Note: All references to Oracle Single Sign-On and Oracle Delegated Administration Services in this appendix refer to Oracle Single Sign-On 10g (10.1.4.3.0) or later and Oracle Delegated Administration Services 10g (10.1.4.3.0) or later.

Problems and Solutions

This section describes common Oracle Internet Directory error messages, problems and solutions. It contains the following topics:

- [Installation Errors](#)
- [Oracle Database Server Errors](#)
- [Directory Server Error Messages and Causes](#)
- [Getting a Core Dump and Stack Trace When Oracle Internet Directory Crashes](#)
- [TCP/IP Problems](#)
- [Troubleshooting Password Policies](#)
- [Troubleshooting Directory Performance](#)
- [Troubleshooting Port Configuration](#)
- [Troubleshooting Creating Oracle Internet Directory Component with opmnctl](#)
- [Troubleshooting Starting Oracle Internet Directory](#)
- [Troubleshooting Starting, Stopping, and Restarting of the Directory Server](#)
- [Troubleshooting Oracle Internet Directory Replication](#)
- [Troubleshooting Change Log Garbage Collection](#)
- [Troubleshooting Dynamic Password Verifiers](#)
- [Troubleshooting Oracle Internet Directory Password Wallets](#)
- [Troubleshooting bulkload](#)
- [Troubleshooting bulkdelete, bulkmodify, and ldifwrite](#)

- [Troubleshooting catalog](#)
- [Troubleshooting remtool](#)
- [Troubleshooting Server Chaining](#)
- [Viewing Version Information](#)
- [Troubleshooting Fusion Middleware Control and WLST](#)
- [Troubleshooting Oracle Directory Services Manager](#)

Installation Errors

During installation and configuration of the Oracle Database, Oracle recommends that you select the character set AL32UTF8 to avoid possible problems with multibyte characters.

Oracle Database Server Errors

Because Oracle Internet Directory relies on Oracle Database, database errors can cause directory server problems. This section lists some database errors you might see in the Oracle Internet Directory logs.

See Also: ["Poor Oracle Database Server Performance"](#) on page R-11.

Oracle Database Server Connection is Down

Oracle Internet Directory shuts down. You see error ORA-3113 or ORA-3114 in the log file.

Problem

Oracle Internet Directory has lost its connection to Oracle Database.

Solution

Check database and listener status, either directly on the host where they are running, or through. Restart them if necessary. OIDMON automatically detects that the database is up and restarts OIDLDP servers.

Oracle Database Server Error Due to Interrupted Client Connection

You get error `sgslunrRead` or `30SendPort`

Problem

These errors indicate that an LDAP client has disconnected abruptly.

Possible reasons include:

- The client program terminated the connection without performing an unbind or abandon.
 - The client machine shut down.
- A network component, such as a load balancer or firewall, broke the connection due to a configured timeout setting.
- The network is down.

Solution

These errors are due to conditions external to the server. If necessary, inform the network administrator.

Oracle Database Server Error Due to Schema Modifications

You get error ORA-1562.

Problem

If you attempt to add more schema components than can fit in the rollback segment space, you encounter this error and the modifications do not commit.

Solution

To solve this, increase the size of the rollback segments in the database server.

Directory Server Error Messages and Causes

This section contains a list of Oracle directory server error messages that you might encounter. Each message is followed by its most probable causes. Also see *Oracle Fusion Middleware Error Messages Reference*.

Inappropriate Authentication Error

You see the following error message on the command line when attempting an anonymous bind to the server:

```
ldap_bind: Inappropriate authentication
ldap_bind: additional info: Server is Configured to Deny Anonymous Binds
```

Problem

Anonymous binds are disabled. In most environments, some clients require anonymous access.

Solution

Enable anonymous binds.

See Also: ["Managing Anonymous Binds"](#) on page 32-8 for more information.

Constraint Violation Error Due to Editing a User or Group or Creating a Realm

You get the following error in `oidldap*.log`:

```
ORA-01483: invalid length for DATE or NUMBER bind variable.
```

You may also see the following error on your screen:

```
LDAP: error code 19 - Constraint Violation
```

These errors might only occur intermittently.

Problem

If you loaded the OracleAS Metadata Repository into an Oracle 10g Database that uses the AL32UTF8 character set, you may encounter some errors when you try to edit a user or Group, or Create Identity Management Realms in Oracle Internet Directory. Editing a user includes editing attributes for an existing user.

Solution

As a workaround, you can wait a bit and try editing the user again.

Standard Error Messages Returned from Oracle Directory Server

Table R-1 lists standard error messages and their causes. Oracle Internet Directory also returns other messages listed and described in "[Additional Directory Server Error Messages](#)" on page R-5.

Table R-1 Standard Error Messages

Error	Cause
00: LDAP_SUCCESS	The operation was successful.
01: LDAP_OPERATIONS_ERROR	General errors encountered by the server when processing the request.
02: LDAP_PROTOCOL_ERROR	The client request did not meet the LDAP protocol requirements, such as format or syntax. This can occur in the following situations: Server encounters a decoding error while parsing the incoming request. The request is an add or modify request that specifies the addition of an attribute type to an entry but no values specified. Error reading SSL credentials. An unknown type of modify operation is specified (other than LDAP_MOD_ADD, LDAP_MOD_DELETE, and LDAP_MOD_REPLACE) Unknown search scope
03: LDAP_TIMELIMIT_EXCEEDED	Search took longer than the time limit specified. If you have not specified a time limit for the search, Oracle Internet Directory uses a default time limit of one hour.
04: LDAP_SIZELIMIT_EXCEEDED	More entries match the search query than the size limit specified. If you have not specified a size limit for the search, Oracle Internet Directory uses a default size limit of 1000.
05: LDAP_COMPARE_FALSE	Presented value is not the same as the one in the entry.
06: LDAP_COMPARE_TRUE	Presented value is same as the one in the entry.
07: LDAP_STRONG_AUTH_NOT_SUPPORTED	The requested bind method is not supported by the server. For example, SASL clients requesting Kerberos authentication from Oracle Internet Directory receive this error in response.
09: LDAP_PARTIAL_RESULTS	Server returned a referral.
10: LDAP_REFERRAL	Server returned a referral.
12: LDAP_UNAVAILABLE_CRITICAL_EXTENSION	Specified request is not supported
16: LDAP_NO_SUCH_ATTRIBUTE	Attribute does not exist in the entry specified in the request.
17: LDAP_UNDEFINED_TYPE	Specified attribute type is undefined in the schema.
19: LDAP_CONSTRAINT_VIOLATION	The value in the request violated certain constraints.
20: LDAP_TYPE_OR_VALUE_EXISTS	Duplicate values specified for the attribute.
21: LDAP_INVALID_SYNTAX	Specified <i>attribute</i> syntax is invalid. In a search, the <i>filter</i> syntax is invalid.

Table R-1 (Cont.) Standard Error Messages

Error	Cause
32: LDAP_NO_SUCH_OBJECT	The base specified for the operation does not exist.
34: LDAP_INVALID_DN_SYNTAX	Error in the DN syntax.
49: LDAP_INVALID_CREDENTIALS	Bind failed because the credentials are not correct.
50: LDAP_INSUFFICIENT_ACCESS	The client does not have access to perform this operation.
53: LDAP_UNWILLING_TO_PERFORM	General error, or server is in read-only mode.
65: LDAP_OBJECT_CLASS_VIOLATION	A change to the entry violates the object class definition.
66: LDAP_NOT_ALLOWED_ON_NONLEAF	The entry to be deleted has children.
67: LDAP_NOT_ALLOWED_ON_RDN	Cannot perform the operation on RDN attributes—for example, you cannot delete the RDN attribute of the entry.
68: LDAP_ALREADY_EXISTS	Duplicate ADD condition.
81: LDAP_SERVER_DOWN	Cannot contact the directory server. This message is returned from the SDK.
82: LDAP_LOCAL_ERROR	The client encountered an internal error. This message is returned from the client SDK.
83: LDAP_ENCODING_ERROR	The client encountered an error in encoding the request. This message is returned from the SDK.
84: LDAP_DECODING_ERROR	The client encountered an error in decoding the request. This message is returned from the SDK.
85: LDAP_TIMEOUT	Client encountered the time out specified for the operation. This message is returned from the SDK.
86: LDAP_AUTH_UNKNOWN	Authentication method is unknown to the client SDK.
87: LDAP_FILTER_ERROR	Bad search filter
88: LDAP_USER_CANCELLED	User cancelled operation
89: LDAP_PARAM_ERROR	Bad parameter to an LDAP routine
90: LDAP_NO_MEMORY	Out of memory

Additional Directory Server Error Messages

[Table R-2](#) lists additional directory server error messages and their causes. These messages do not display error codes.

The Oracle Internet Directory application replaces the *parameter* tag seen in some of the following messages with the appropriate run-time value.

Table R-2 Additional Error Messages

Error	Cause
%s attribute not found	The particular attribute type is not defined in the schema.
<i>parameter</i> not found for attribute <i>parameter</i>	Value not found in the attribute. (ldapmodify)
Admin domain does not contain schema information for objectclass <i>parameter</i>	The object class specified in the request is not present in the schema.
Attempted to add a Class with oid <i>parameter</i> taken by other class	Duplicate object identifier specified. (schema modification)
Attribute <i>parameter</i> already in use	Duplicate attribute name. (schema modification)
Attribute <i>parameter</i> has syntax error.	Syntax error in the attribute name definition. (schema modification)
Attribute <i>parameter</i> is not supported in the schema.	Attribute not defined. (all operations)
Attribute <i>parameter</i> is single valued.	Attribute is single-valued. (ldapadd and ldapmodify)
Attribute <i>parameter</i> not present in the entry.	This attribute does not exist in the entry. (ldapmodify)
Bad attribute definition.	Syntax error in attribute definition. (schema modification)
Currently Not Supported	The version of LDAP request is not supported by this server.
Entry to be deleted not found.	DN specified in the delete operation not found.
Entry to be modified not found	The entry specified in the request is not found.
Error encountered while adding <i>parameter</i> to the entry	Returned when modify add operation is invoked. A possible cause is that the system resource is unavailable.
Error encountered while encrypting an attribute value.	Error in encrypting user password. (all operations)
Error in DN Normalization.	DN specified is invalid. Syntax error encountered in parsing the DN. (all operations)
Error in hashing <i>parameter</i> attribute.	Error in creating hash entry for the attribute. (schema modification)
Error in hashing <i>parameter</i> objectclass.	Error in creating hash entry for the objectclass. (schema modification)
Error in Schema hash creation.	Error while creating hash table for schema. (schema modification)
Error replacing <i>parameter</i> .	Error in replacing this attribute. (ldapmodify)
Error while normalizing value for attribute <i>parameter</i> .	Error in normalizing value for the attribute. (all operations)
Failed to find <i>parameter</i> in mandatory or optional attribute list.	Attribute specified does not exist in either the mandatory or optional attribute list as required by the object class(es).
Function Not Implemented	The feature/request is currently not supported. (Specifying a non-indexed attribute in a search can generate this error.)

Table R-2 (Cont.) Additional Error Messages

Error	Cause
INVALID ACI is <i>parameter</i>	The particular ACI you specified in a request is invalid.
Mandatory attribute <i>parameter</i> is not defined in Admin Domain <i>parameter</i> .	MUST refers to attribute not defined. (schema modification)
Mandatory Attribute missing.	The mandatory attribute for the particular entry is missing, as required by the particular object class.
Matching rule, <i>parameter</i> , not defined.	Matching rule not defined in the server. (schema modification)
MaxConn Reached	The maximum number of concurrent connections to the LDAP server has been reached.
Modifying the Naming attribute for the entry without modifying the DN.	Cannot modify the naming attributes using ldapmodify. A naming attribute, such as cn is an element in the DN.
New Parent not found.	New parent specified in modifydn operation does not exist.(ldapmodifydn)
Object already exists.	Duplicate entry. (ldapadd and ldapmodifydn)
Object ID <i>parameter</i> already in use.	Duplicate object identifier specified. (schema modification)
Objectclass <i>parameter</i> already in use.	Duplicate Objectclass name. (schema modification)
Objectclass attribute missing.	The objectclass attribute is missing for this particular entry.
OID <i>parameter</i> has syntax error.	syntax error in the object identifier definition. (schema modification)
One of the attributes in the entry has duplicate value.	You entered two values for the same attribute in the entry you are creating.
Operation not allowed on the <i>parameter</i> .	Operation not allowed on this entry. (modify, add, and delete)
Operation not allowed on the DSE Entry.	Can't do this operation on DSE entry. (delete)
Optional attribute <i>parameter</i> is not defined in Admin Domain <i>parameter</i> .	MAY refers to attribute not defined. (schema modification)
Parent entry not found in the directory.	Parent entry does not exist. (ldapadd and perhaps ldapmodifydn)
Super object <i>parameter</i> is not defined in Admin Domain <i>parameter</i> .	SUP types refer to non-existing class. (schema modification)
Super type undefined.	SUP type does not exist. (schema modification)
Superuser addition not permitted.	Cannot create superuser entry. (ldapadd)
Syntax, <i>parameter</i> , not defined.	Syntax not defined in the server. (schema modification)
The attribute or the value specified in the RDN does not exist in the entry.	AVA specified as the RDN does not exist in the entry. (ldapadd)

Table R–2 (Cont.) Additional Error Messages

Error	Cause
Unknown search scope	The search scope specified in the LDAP request is not recognized.
Version Not Supported	The version of the LDAP request is not supported by this server.
Alias Problem	Either of the following have occurred: <ul style="list-style-type: none"> ■ An alias was dereferenced, but it did not point to an entry in the DIT. ■ The user tries to add an alias entry whose parent is an alias.
Alias Dereferencing Problem	The user cannot dereference an alias because of access control issues.
No Such Object	The server cannot find the base DN specified in the search request.
Invalid DN Syntax	When adding or modifying an alias entry, if the value specified for <code>aliasedObjectName</code> has invalid DN syntax, then the directory server returns this error message to the client.
Insufficient Access Rights	The user does not have access to the dereferenced entry.

Getting a Core Dump and Stack Trace When Oracle Internet Directory Crashes

You can control the type of information Oracle Internet Directory provides when it crashes by changing the value of the `orclsdumpflag` attribute in the instance-specific configuration entry.

If the server crashes, it leaves a core file under the directory

```
ORACLE_INSTANCE/diagnostics/logs/OID
```

If `orclsdumpflag` is set to 0, and the server crashes, in addition to the core dump, the server also attempts to leave a stack trace. The location for the stack trace is:

```
ORACLE_INSTANCE/diagnostics/logs/OID/compName/oidldapd_stack00_pid.dmp
```

Some operating system-specific settings can affect the generation of a core dump or stack trace. Consult your operating system documentation to determine whether the following settings are required:

- The `coredump` parameter must be set to allow core dumps.
- The file size limit, as specified with the `ulimit` command, must be sufficient to allow core dumps.
- The file permissions on the `ORACLE_HOME/bin/oidldapd` binary file must allow read by group. You can ensure that group has read permission by typing:

```
chmod g+r $ORACLE_HOME/bin/oidldapd
```

as the root user.

TCP/IP Problems

TCP/IP bugs in the operating system can interfere with Oracle Internet Directory service.

Do Not Use TCP-Based Monitoring of Server Availability on Windows 2003 Server

If you use the F5 load balancer for monitoring Oracle Internet Directory server availability, configure the load balancer to use LDAP- or HTTP-based monitoring, as described in the *Oracle Fusion Middleware High Availability Guide* section "Configuring A Load Balancer For OracleAS Cluster (Identity Management)." Using TCP-based monitoring might cause the service to become unavailable, due to an operating system bug on Microsoft Windows 2003 Server.

Do Not Install DaimondCS Port Explorer

Oracle Internet Directory does not work if DaimondCS Port Explorer is installed on the system.

Troubleshooting Password Policies

This section describes error messages and problems related to password policies.

Password Policy is Not Enforced

The password policy is not being enforced for a given user or set of users. For example, users can reset their password using a syntax that is disallowed by the defined password policy.

Problem

Just creating a password policy is not sufficient. You must also specify the subtree to be governed by the policy.

Solution

Add and populate a `pwdPolicysubentry` attribute with the policy's DN, at the root of that subtree.

See Also: ["Steps Required to Create and Apply a Password Policy"](#) on page 28-2 for more information.

Password Policy Error Messages

[Table R-3](#) contains the error messages sent to the client as a result of password policy violations. The error codes are not standard LDAP error codes. They are messages sent as a part of additional information in the LDAP result.

Table R-3 Password Policy Violation Error Messages

Error Number	Exception	Comment or Resolution
9000	GSL_PWDEXPIRED_EXCP	User's password has expired.
9001	GSL_ACCOUNTLOCKED_EXCP	User account is locked.
9002	GSL_EXPIREWARNING_EXCP	User password will expire in <code>pwdexpirewarning</code> seconds. Please change your password now.
9003	GSL_PWDMINLENGTH_EXCP	User password is not the required number of characters long.
9004	GSL_PWDNUMERIC_EXCP	User password does not contain required numeric characters.
9005	GSL_PWDNULL_EXCP	User password is a null password, which is disallowed.
9006	GSL_PWDINHISTORY_EXCP	User's new password is the same as an old one saved in history, which is disallowed. (The <code>pwdinhistory</code> attribute controls the number of passwords saved in history.)

Table R-3 (Cont.) Password Policy Violation Error Messages

Error Number	Exception	Comment or Resolution
9007	GSL_PWDILLEGALVALUE_EXCP	The user password supplied is an illegal value defined in <code>orclpwdillegalvalues</code> , and therefore cannot be used.
9008	GSL_GRACELOGIN_EXCP	User password has expired. User has <code>pwdgraceloginlimit</code> grace logins left or <code>orclpwdgracelogintimelimit</code> seconds in which grace logins are allowed.
9012	GSL_PWDALPHA_EXCP	Your Password must contain at least <code>orclpwminalphachars</code> alphabetic characters.
9013	GSL_PWDSPECIAL_EXCP	Your Password must contain at least <code>orclpwminspectialchars</code> special characters.
9014	GSL_PWDUPPER_EXCP	Your Password must contain at least <code>orclpwmdupper</code> upper case characters
9015	GSL_PWDMAXCHAR_EXCP	Your Password can only contain <code>orclpwmmaxrptchars</code> repeated characters
9016	GSL_PWDLOWER_EXCP	Your Password must contain at least <code>orclpwmdupper</code> lowercase characters.
9017	GSL_EC_PWDPOLSUBENTINV	The <code>pwdPolicysubentry</code> provided is invalid. (The DN is not that of a valid password policy present in the directory.)
9018	GSL_EC_PWDPOLINUSE	The <code>pwdPolicy</code> entry you are deleting is currently in use. (You must remove the references to the password policy before the policy itself can be removed.)
9019	GSL_EC_PWDPOLOBJ	The DN of a <code>pwdPolicy</code> entry may not be modified.
9020	GSL_PWDMINAGE_EXCP	Your Password has to be at least <code>pwdminage</code> seconds old before it can be changed.
9032	GSL_EC_GRACE_CONST	<code>orclgracelogintimelimit</code> and <code>pwdgraceloginlimit</code> are mutually exclusive. Both cannot be nonzero.
9033	GSL_EC_NOROOTDSEPWDPOL	The <code>pwdpolicysubentry</code> attribute in the root DSE cannot be deleted. (This is not allowed because it would leave the directory without an applicable password policy.)
9034	GSL_EC_NOTROCPWDPOL	Only password policies defined in the Root Oracle Context are applicable in the Root DSE. (This ensures that only a policy specified by an admin who has directory-wide privileges can be applied to the entire directory.)
9050	GSL_ACCTDISABLED_EXCP	User account has been disabled.

See Also: [Chapter 12, "Managing Accounts and Passwords"](#).

Troubleshooting Directory Performance

This section gives some quick pointers for common performance-related problems.

Poor LDAP Search Performance

LDAP search performance is poor.

Problem

Various problems.

Solution

Make sure that:

- Schema associated with the ODS user is ANALYZED
- For searches involving multiple filter operands, make sure that the order in which they are given goes from the most specific to the least specific. For example, `&(uid=john.doe) (objectclass=person)` is better than `&(objectclass=person) (uid=john.doe)`.

Also see "[Poor Oracle Database Server Performance](#)" on page R-11.

Poor LDAP Add or Modify Performance

LDAP add or modify performance is poor.

Problem

Various problems

Solution

Make sure that:

- There are enough redo log files in the database
- The undo tablespace in the database is large enough
- The schema associated with the ODS user is ANALYZED

When estimating the statistics, you can use the OID Database Statistics Collection tool to analyze the various database ODS schema objects.

Both the tracing functionality described in [Chapter 23, "Managing Logging"](#) and the database tracing event 10046 can assist you in diagnosing performance issues.

See Also: The `oidstats.sql` command-line tool reference in *Oracle Fusion Middleware Reference for Oracle Identity Management* for instructions on using the OID Database Statistics Collection tool

The Oracle Internet Directory chapter in *Oracle Fusion Middleware Performance and Tuning Guide* for instructions on optimizing searches

Note 243006.1 on My Oracle Support (formerly MetaLink), <http://metalink.oracle.com>, for information on performance issues with group entries

Poor Oracle Database Server Performance**Problem**

Oracle database server is consuming lot of processor resources during LDAP search operations.

Solution

Proceed as follows:

1. Identify the LDAP operations that are processor-intensive by running:

```
oidctl connect=connstr status -diag
```

This command displays the LDAP operation and associated SQL that is being executed.

2. Tune the database appropriately for this kind of query. See the Oracle Internet Directory chapter in Oracle Fusion Middleware Performance and Tuning Guide.
3. If possible, change the applications's search signature. If that is not possible, tune the Oracle Internet Directory attribute `orclinmemfiltprocess`. See the Oracle Internet Directory chapter in *Oracle Fusion Middleware Performance and Tuning Guide*.

Troubleshooting Port Configuration

You can find out which ports the Oracle Internet Directory dispatcher is using for SSL and non-SSL connections in the following ways:

- In Oracle Enterprise Manager Fusion Middleware Control, select **Port Usage** from the OID menu.
- From the command line, execute:

```
ORACLE_INSTANCE/bin/opmnctl status -l
```
- From the command line, execute:

```
oidctl connect=oiddb status
```

Troubleshooting Creating Oracle Internet Directory Component with opmnctl

Problem

The command `opmnctl createcomponent` fails and the following error appears in the file `ORACLE_INSTANCE/diagnostics/logs/OPMN/opmn/provision.log`:

```
INFO: $ORACLE_INSTANCE/config/tnsnames_copy.ora file does not exist
```

Solution

Ensure that the following are true:

- The file `ORACLE_INSTANCE/config/tnsnames_copy.ora` exists
- The `OIDDB connectString` is present in `ORACLE_INSTANCE/config/tnsnames.ora`
- The `connectString` in the `OID Snippet` in `ORACLE_INSTANCE/config/OPMN/opmn/opmn.xml` is the same as in `ORACLE_INSTANCE/config/tnsnames.ora`. `OIDDB` is the default.

Then retry `opmnctl createcomponent`.

Troubleshooting Starting Oracle Internet Directory

This section describes problems you might encounter when starting Oracle Internet Directory.

Oracle Internet Directory is Down

Problem

Oracle Enterprise Manager Fusion Middleware Control shows Oracle Internet Directory down. The command:

```
opmnctl status
```

shows that `oidmon` is down, as well as all the `oidldapd` processes.

Solution

Consult the OPMN log, `ORACLE_HOME/opmn/logs/opmn.log` to determine why `oidmon` is not starting.

Problem

Oracle Enterprise Manager Fusion Middleware Control shows Oracle Internet Directory down. The command:

```
opmnctl status
```

shows that `oidmon` is up, but the `oidldapd` processes are down.

Solution

Check the following logs in the order shown:

1. The `oidmon` log, `ORACLE_INSTANCE/diagnostics/logs/OID/componentName/oidmon-0000.log` contains details as to why `oidmon` cannot start the `oidldapd` process. The most common issues are
 - Unable to connect to Oracle Database: Ensure that the Oracle database and listener are up and running.
 - Time difference between the two nodes is more than 250 seconds: Adjust the system time.
 - `oidmon` keeps trying to start `oidldapd` processes, but they fail to run. To debug, see Step 2.
2. The Oracle Internet Directory dispatcher log, `ORACLE_INSTANCE/diagnostics/logs/OID/componentName/oidldapd01-0000.log` contains information about why `oidldapd` server processes fail to start. The most common reasons are:
 - Configured PORT for Oracle Internet Directory is not free: Execute

```
netstat -an | grep oidPort
```

 to see if the port is free.
 - Oracle Internet Directory is configured to listen on a port number less than 1024 on a UNIX or Linux system and the executable binary file `ORACLE_HOME/bin/oidldapd` is either not owned by `root` or does not have the `setuid` bit set.
 - The `oidldapd` dispatcher keeps spawning `oidldapd` server processes, but they fail to run. In this case, you might see a single `oidldapd` dispatcher process running if you use `ps` on UNIX or Linux or Task Manager on Windows. To debug, see Step 3.

3. The Oracle Internet Directory server log, `ORACLE_INSTANCE/diagnostics/logs/OID/componentName/oidldapd01sPID-0000.log` contains information about why the server processes fail to run. Common issues include:
 - Unable to create Oracle Database connection pool: Check the Oracle Database `PROCESSES` parameter and increase if necessary.
 - Oracle Internet Directory is configured to use an SSL wallet file, and that file is inaccessible.

Oracle Internet Directory is Read-Only

Problem

The Oracle Internet Directory server starts in read-only mode.

Solution

This usually indicates that the Oracle Internet Directory server has been started against the wrong schema. To verify, type these two commands:

```
oidldapd -v  
  
ldapsearch -p oidPort -D cn=orcladmin -q -b "" -s base "objectclass=*" Orcldirectoryversion
```

If these commands show different versions, the server starts in read-only mode.

Troubleshooting Starting, Stopping, and Restarting of the Directory Server

To troubleshoot starting and stopping the directory server, you must know the purpose of each tool involved, how all the tools work together, and the overall process for starting and stopping the server.

See Also: The Oracle Internet Directory chapter in Oracle Fusion Middleware Performance and Tuning Guide.

About the Tools for Starting, Stopping, and Restarting the Directory Server Instance

You start the directory server instance by typing:

```
opmnctl startproc process-type=OID  
opmnctl stopproc process-type=OID
```

OIDCTL When `OIDCTL` is executed, it connects to the database as user `ODS`. Depending on the options used in the command, it either inserts or updates rows into a table named `ODS.ODS_PROCESS_STATUS_STATUS`. If the `START` option is used, then a row is inserted. If either the `STOP` or `RESTART` option is used, then a row is updated.

The `ODS.ODS_PROCESS_STATUS` table includes the following information:

- `instance`: The unique number of the instance, any value between 0 and 1000
- `pid`: Process identifier, which is updated by `OIDMON` when the process is started
- `state`: The type of operation requested

The possible values for `state` are:

- 0=stop

- 1=start
- 2=running
- 3=restart
- 4=shutdown
- 5=failedover

Note: When OPMN stops the directory server, the value for state is initially 4, that is, shutdown. However, when OPMN starts the directory server again, the state value becomes 2, that is, running.

OIDMON To start, stop, or restart a directory server instance, OIDMON must be running. At specified intervals, this daemon checks the value of the `state` column in the `ODS.ODS_PROCESS_STATUS` table.

If it finds a row with `state=0`, then it reads the `pid` and stops the process.

If it finds one with `state=1` or `state=4`, then it starts a new process and updates the `pid` column with a new process identifier.

If it finds one with `state=2`, then it reads the `pid` and verifies that the process with that `pid` is running. If it is not running, then OIDMON starts a new process and updates the `pid` column with a new process identifier.

If it finds a row with `state=3`, then OIDMON reads the `pid`, stops the process, starts a new one, and updates the `pid` accordingly.

If it is unsuccessful, it pushes the request to another node.

In short, OIDCTL inserts and updates state information in the rows in the `ODS.ODS_PROCESS_STATUS` table. OIDMON then reads that information and performs the specified task.

About the Processes Involved in Starting, Stopping, and Restarting the Directory Server

Starting, stopping and restarting the directory server involves processes. OIDMON is one process. On UNIX, it is called `oidmon`. In a Microsoft Windows environment, it is called `oidmon.exe`.

To start an instance, OIDMON checks the unique number in the `instance` column mentioned in the previous section. It then starts another process, namely, the listener/dispatcher, which is different from the Oracle Net Services listener process. It stores the process identifier for that new process in the `pid` column.

The listener/dispatcher, in turn, starts a number of server processes as defined in the configuration set entry. Note that these server processes are controlled by the listener/dispatcher and not by OIDMON. If one of these processes fails, then it is automatically restarted by the listener/dispatcher.

Together, the listener/dispatcher and the server processes constitute a directory server instance. On UNIX, this directory server instance is called `oidldapd`. On Microsoft Windows, they are called `oidldapd.exe`.

In short, there are at least three processes: one for OIDMON and at least two for the directory server itself. When all processes are running, you should see something like the following on UNIX computers:

```
% ps -ef|grep oid
root 12387 12381 0 Mar 28 ? 0:05 oidldapd -i 1 -conf 0 key=811436710
root 12381 1 0 Mar 28 ? 0:10 oidmon start
root 13297 1 0 Mar 28 ? 0:14 oidldapd
```

Another way to obtain server information is by running:

```
oidctl connect=oiddb status.
```

Problems Starting, Stopping, and Restarting the Directory Server

This section describes some problems you might have when starting, stopping, or restarting the directory server.

OIDCTL or OIDMON fails Either OIDCTL or OIDMON can fail for reasons.

Problem

Incorrect syntax

Solution

Verify that you are using the correct syntax as described in "Oracle Internet Directory Administration Tools" in *Oracle Fusion Middleware Reference for Oracle Identity Management*. Note that the correct value of the connect option when using OIDCTL is the TNS alias—that is, the connect string—and not a host name or other value. See Note 155790.1, on My Oracle Support (formerly MetaLink), <http://metalink.oracle.com>.

Problem

The Oracle Internet Directory-designated database is not running.

The Oracle Net Services configurations are incorrect.

Solution

Verify that the Oracle Internet Directory-designated database and the Oracle Net Services components are correctly configured and running. To do this, see if you can connect to the database by using SQL*Plus that is installed in the same *ORACLE_HOME* as OIDCTL. Log in as *ODS/ods_password@tns_alias* where *tns_alias* is the same as that used in the connect option with OIDCTL. See Note 155790.1, on My Oracle Support (formerly MetaLink), <http://metalink.oracle.com>.

Problem

Missing *oidldapd* file.

Solution

See *\$ORACLE_INSTANCE/diagnostics/logs/OID/componentName/oidmon-XXXX.log*. Look for the message: No such file or directory. To correct the problem, replace the executable file.

Problem

Wrong permissions on *oidldapd* executable file.

Solution

Look for the message `Exec of OIDLDAPD failed with error 13`. On UNIX, the `$ORACLE_HOME/bin/oidldapd` file must have the following permissions:

```
-rws--x--- 1 root dba 1691802 Jan 20 10:30 oidldapd
```

If the permissions are not correct, type the following, as root:

```
cd $ORACLE_HOME/bin
chown root:dba oidldapd
chmod 0710 oidldapd
chmod u+s oidldapd
```

Problem

You are running as a user with insufficient privilege

Solution

To confirm that this is the problem, see `ORACLE_INSTANCE/diagnostics/logs/OID/componentName/oidmon-XXXXX.log`.

Look for the message: `Permission denied or Open Wallet failed`. This happens if you are not running either as `root` or as the user who is in the `dba` group. To correct the problem, try again as the correct user.

Problem

A port is in use.

Solution

See

```
ORACLE_INSTANCE/diagnostics/logs/
OID/componentName/oidldapd00sPID-XXXX.log.
```

Look for the message: `Bind failed on...` This indicates that the port that `oidldapd` is configured to listen on is in use by some other process. To determine which process is using the port, type:

```
netstat -a | grep portNum
```

If necessary, reconfigure the other process to use a different port or configure `oidladapd` to listen on another port by adding a `configset`. Remember that, by default, `oidladapd` listens on two ports, an SSL and non-SSL port.

Problem

On a cluster or Oracle Application Server Cluster (Identity Management) configuration, `OIDMON` pushes the server to another node in a cluster when it cannot start the server on the local node.

Solution

See `oidmon.log`. Look for the message: `gslsgfrPushServer: Could not start server on NodeA, trying to start on nodeNodeB`. To correct this problem, you must first determine why `OIDMON` cannot start the server on the local node.

Problem

A possible problem with Oracle Net Services or with the database itself.

Solution

See `oidmon.log`, `oidldapdxx.log`, where `xx` is the server instance number.

A Row is Missing from ODS.ODS_PROCESS_STATUS

Problem

In a cluster or Oracle Application Server Cluster (Identity Management) configuration, OIDMON successfully starts `oidldapd` on both nodes, but then initiates failover due to a time stamp difference.

Solution

See the trace files `oidldapdxx.log` where `xx` is the instance number, and `oidldapdxxsy.log` where `xx` is the instance number and `yy` is the process identifier. If the trace files do not give useful information or pointers to My Oracle Support (formerly MetaLink) documents, then do the following: (1) Stop the directory server processes; (2) Remove or rename old trace files; (3) Start OIDMON and a directory server with maximum debug level, namely, 11744051. Note that, to get the trace files, you must first stop, then start, the server; you cannot simply restart it. Investigate the new trace files, and, if needed, log an iTAR with Oracle Support Services and upload the trace files to the iTAR. See Note 155790.1, on My Oracle Support (formerly MetaLink), <http://metalink.oracle.com>.

See Also: The `oidctl` command-line tool reference in *Oracle Fusion Middleware Reference for Oracle Identity Management* for more information on failover.

Troubleshooting Oracle Internet Directory Replication

This section discusses directory replication problems.

Whenever you investigate a replication problem, be sure to consult the log files for information. The log files are `ORACLE_`
`INSTANCE/diagnostics/logs/OID/componentName/oidrepld-XXXX.log`,
`oidldapd00-XXXX.log` and `ORACLE_`
`INSTANCE/diagnostics/logs/OID/componentName/oidldapd00sPID-XXXX.`
`log` where `PID` is the server process identifier and `XXXX` is a number from 0000 to `orclmaxlogfiles` configured.

The replication server supports multiple debugging levels. To turn on replication debugging, use either `ldapmodify` or the Shared Properties, Replication tab, in Fusion Middleware Control to change `orcldebuglevel` in the replication configuration set.

Note: Turning on debugging affects replication performance.

See Also: [Chapter 40, "Managing Replication Configuration Attributes"](#) for more information.

Bootstrapping Fails

Disable referential integrity during the replication bootstrapping process. If referential integrity is enabled, bootstrapping fails.

Replication Server Does Not Start

There are several problems that can prevent the replication server from starting.

Problem

Invalid `oidctl` syntax

Solution

Use the following syntax to start the replication server.:

```
oidctl server=oidrepld connect=connect_string instance=instance_number \
      flags="-h host -p port"
```

Problem

Oracle Internet Directory is not running at the host and port you specified on the command line when you attempted to start the replication server. This caused the anonymous bind to the target Oracle Internet Directory to fail.

Solution

Make sure the target Oracle Internet Directory is up and running at the specified host and port.

Problem

The replication server is attempting to bind to the host and port specified in either the `orclreplicaprimurl` or the `orclreplicasecondaryurl` attribute of the Replica entry, but Oracle Internet Directory is running at a different host or port.

Solution

If you decide to run Oracle Internet Directory at a different host or port, add the new information to the `orclreplicasecondaryurl` attribute of the replica entry, as follows:

1. Prepare a modification file, `mod.ldif`. For example, to change to host `my.us.example.com` and port `4444`, you would specify:

```
dn: orclreplicaid=replica_ID, cn=replication configuration
changetype: modify
add: orclreplicasecondaryurl
orclreplicasecondaryurl: ldap://my.us.example.com:4444/
```

2. Run:

```
ldapmodify -h host -p port -f mod.ldif
```

Problem

The `ReplBind` credential in the replication wallet `ORACLE_INSTANCE/OID/admin/oidpwrORACLE_SID` is corrupt or invalid. That is, the password stored in the wallet is not the same as the password that is stored in the directory, or the wallet does not exist. This causes the replication bind to fail and the replication server to exit with an error.

You might see messages similar to this example in the file `oidrepldXX.log`:

```
2005/07/21:11:13:28 * gslrcfdReadReplDnPswd:Error reading repl passwd
2005/07/21:11:13:28 * gslrcfcReadReplConfig:Error found.
2005/07/21:11:13:28 * Failed to read replication configuration information.
```

Solution

Use `remtool` to fix the replication bind credential in the replication wallet or to synchronize between Oracle Internet Directory and the replication wallet.

- `remtool -pchgpwd` changes the password of the replication dn of a replica. Use this option if you know the current replication DN password stored in the directory and you want to change it both in the directory and in the wallet.
- `remtool -presetpwd` resets the password of the replication dn of a replica. Use this option if you know the current replication DN password stored in the directory and you want to change it both in the directory and in the wallet.
- `remtool -pchgwlpwd` changes password of replication dn of a replica only in the wallet. Use this option if you know the replication DN password stored in the directory but you are not sure whether the wallet has the correct password or you want to create the wallet file.

All of these options create a wallet if one does not already exist.

See Also:

- The `remtool` command-line tool reference in *Oracle Fusion Middleware Reference for Oracle Identity Management* for more information about using `remtool`
- The `oidpasswd` command-line tool reference in *Oracle Fusion Middleware Reference for Oracle Identity Management* for more information about using `oidpasswd`

Problem

The replication server is attempting to bind to an SSL port that is configured for one-way or two-way authentication.

Solution

Configure the replication server to use either the non-SSL port or an SSL port configured for no authentication. You can use a separate Oracle Internet Directory server instance just for replication.

See Also: ["Secure Sockets Layer \(SSL\) and Oracle Internet Directory Replication"](#) on page 38-7.

Repository Creation Assistant Error**Problem**

When you use the Oracle Application Server tool RepCA to load Oracle Internet Directory schema into an existing Oracle 10.1.0.3 Database, you might see the following error message in the `ORACLE_`

`INSTANCE/diagnostics/logs/OID/tools/repca*log` file:

```
SP2-0332: Cannot create spool file.
```

Solution

This error message can be ignored.

Errors in Replication Bootstrap

errors can occur in replication bootstrap.

Problem

Some of the naming contexts failed to be bootstrapped.

Solution

Identify the naming contexts that failed to be bootstrapped, and use the `oidcmprec` tool to reconcile them. Then resume replication by setting the consumer's replica state to ONLINE mode

Problem

Various causes.

Solution

Identify the cause of the bootstrap failure and fix the cause, then restart bootstrapping by setting consumer's replica state to BOOTSTRAP mode.

Solution

To determine the exact cause of the error, examine the log file `oidldapdxx.log`. Look for error messages like those in the following example:

```
2004/09/14:12:57:23 * Starting OIDREPLD against dlsun1418:4444...
2004/09/14:12:57:25 * Starting scheduler...
2004/09/14:12:57:26 * Start to BootStrap from supplier=dlsun1418_replica to
consumer=dlsun1418_replica2
2004/09/14:12:57:27 * gslrbssSyncDIT:Replicating namingcontext=cn=oraclecontext
.....
2004/09/14:12:58:21 * gslrbssSyncDIT:Sync done successfully for namingctx:
cn=oraclecontext, 222 entries matched
2004/09/14:12:58:21 * gslrbssSyncDIT:Replicating namingcontext=cn=joe smith .....
2004/09/14:12:58:23 * BootStrap failure when adding DN=cn=Joe Smith,
server=dlsun1418_replica2,err=Constraint violation.
2004/09/14:12:58:23 * gslrbssSyncDIT:Sync failed for namingctx: cn=joe smith, only
1 entries retrieved
2004/09/14:12:58:23 * gslrbssSyncDIT:Replicating
namingcontext=cn=oracleschemaversion .....
2004/09/14:12:58:25 * gslrbssSyncDIT:Sync done successfully for namingctx:
cn=oracleschemaversion, 10 entries matched
2004/09/14:12:58:51 * gslrbsbBootStrap: Failure occurred when bootstrapping 1 out
of 3 namingcontext(s) from the supplier
```

Identify the cause of the bootstrap failure and fix it. You can identify the naming contexts that caused the problem, then use `oidcmprec` to compare and reconcile the naming contexts. After you resolve the problem, start bootstrapping again by starting the Oracle Internet Directory replication server.

Problem

The Oracle Internet Directory server was shut down during the bootstrapping

Solution

Make sure both the supplier Oracle Internet Directory and the consumer Oracle Internet Directory servers are up and running during replication bootstrapping.

Problem

Some of the entries being bootstrapped cannot be applied at the consumer due to a constraint violation.

Solution

Make sure the Oracle Internet Directory schema of the consumer are synchronized with those of the supplier before starting replication bootstrap. When you add an LDAP replica, `remtool` ensures that the Oracle Internet Directory schema on the consumer replica are synchronized with those on the supplier replica.

Problem

Improper replication filtering during bootstrapping. Replication supports excluding one or more attributes during bootstrapping. However, if a mandatory attribute of an entry is configured to be excluded, that entry cannot be applied at the consumer due to an objectclass violation.

Solution

Follow the replication naming context configuration rules in [Chapter 38, "Setting Up Replication"](#) to configure replication filtering properly.

If you are debugging LDAP replication, you should become familiar with the LDAP replica states. If LDAP-based replication is configured, when the replication server starts, it reads the replica state from the local replica. The replication server behaves differently, depending upon the local replica state. LDAP replication errors appear in `oidldapdxx.log`

See Also: ["LDAP Replica States"](#) on page D-5

Problem

When you restart the replication server after the replication server failed to bootstrap a naming context having more than 5000 entries, you may see error messages similar to this in the log file `oidrepld00.log`:

```
2005/04/05:13:21:55 * gslrbssSyncDIT:Replicating namingcontext=dc=com .....
2005/04/05:15:36:09 * gslrbssSyncDIT:Subtree delete on dc=com failed.
Error=DSA is unwilling to perform
2005/04/05:15:36:09 * gslrbssSyncDIT:Sync failed for namingctx: dc=com, only
0 entries retrieved
```

The replication server performs two steps during bootstrap operation. First, in the consumer, it deletes the naming contexts that it has to bootstrap. Second, it copies entries belonging to those naming contexts from supplier to consumer. Deletion by the replication server of a naming context having several thousands of entries results in a big transaction. The undo tablespace must have sufficient space to accommodate a big transaction. If the database's undo tablespace does not have sufficient space, it results in an ORA-30036 error.

Solution

Either have the database administrator add more space to the undo tablespace, or use the `bulkdelete` tool to delete the required naming context before you start the replication server.

Changes Are Not Replicated

Changes are not replicated from one node to another.

Problem

The replication server has run out of table space

Solution

Look for the following message in the server log:

```
OCI Error ORA-1653 : ORA-01653: unable to extend table ODS.ASR_CHG_LOG by 8192 in
tablespace OLTS_DEFAULT
```

Extend the table space and investigate why the table space keeps growing.

Problem

The target Oracle Internet Directory server is down.

Solution

Restart the target Oracle Internet Directory server.

Problem

Various causes

Solution

Make sure the replication server is started on all nodes, in multi-master replication, and at the consumer node in single-master or fan-out replication.

For Oracle Database Advanced Replication-based multimaster replication, use `remtool` to diagnostic and fix problems.

- `remtool -asrverify` verifies the correctness of a DRG setup and reports problems.
- `remtool -asrrectify` verifies the correctness of a DRG setup, reports problems, and attempts to rectify the problems.

Check the replication log and LDAP log for error messages and fix the cause of the error after investigation.

See Also: The `remtool` command-line tool reference in *Oracle Fusion Middleware Reference for Oracle Identity Management* for more information about using `remtool`.

Replication Stops Working**Problem**

Data is not replicated between the replicas. In some cases, a working replication setup stops working after OID Human Intervention Queue entries are applied to one of the nodes. In other cases, adding or deleting a new replica causes problems or failures.

Problem

Various causes

Solution

See the following Notes on My Oracle Support (formerly MetaLink), <http://metalink.oracle.com>:

Note 171693.1, "Resolving Conflicts"

Note 122039.1, "Troubleshooting Basics for Advanced Replication"

Note 213910.1, "Debugging OID Replication when ASR_CHG_LOG Never Gets Populated."

You can search for Notes by entering a term such as "replication" into the search box.

Troubleshooting Change Log Garbage Collection

Both replication and Oracle Directory Integration Platform use change logs to propagate information from a supplier directory to a consumer directory. All change logs are stored in the table `ods_chg_log`. In addition, replication change logs are stored in `asr_chg_log`.

This section discusses possible problems you might encounter with change log garbage collection.

Problem

Garbage collection is not working and Oracle Internet Directory is using Oracle Database 11.2.0.1.

Solution

Apply 11.2.0.1.3 PSU to the database.

Problem

Change logs are not being purged due to a replication issue. For example, if a replication server has been down for a few days, replication change logs are not purged because they are needed for replication recovery.

Solution

Resolve the replication issue. See "[Troubleshooting Oracle Internet Directory Replication](#)" on page R-18".

Problem

The attribute `orclpurgetargetage` is set too high and there are one or more enabled but inactive change log subscribers that do not update `orclLastAppliedChangeNumber` in their subscriber profiles. Change number-based purging won't purge change logs that are not yet consumed and time-based purging won't purge them because they're not old enough.

Solution

Set the attribute `orclpurgetargetage` to a smaller value so that change logs are purged sooner.

Solution

Disable inactive changelog subscribers so that change logs are purged by change log number-based purging. Locate such enabled but inactive subscriber profiles by examining the `orclLastAppliedChangeNumber` in all subscriber profiles by typing:

```
ldapsearch -v -p port -h host -D cn=orcladmin -q \  
-b "cn=changelog subscriber,cn=oracle internet directory" \  
-s sub "objectclass=orclchangesubscriber" \  
orcllastappliedchangenumber orclsubscriberdisable
```

Look for an entry that has `orclSubscriberDisabled` equal to zero and an `orclLastAppliedChangeNumber` value that never changes. If such an entry exists, and the change log garbage collector's `orclpurgetargetage` is zero or greater, delete the value of `orclpurgetargetage`. When `orclpurgetargetage` is not defined or less than zero, the garbage collector purges changes applied by the replication server, even if another subscriber has not updated its `orclLastAppliedChangeNumber`.

See Also: "Change Log Purging" on page 35-5.

Troubleshooting Dynamic Password Verifiers

Table R-4 lists and describes the error messages for dynamic password verifiers.

Table R-4 Error Messages for Dynamic Password Verifiers

Error Code	Description
9022	A reversible encrypted password is missing from the user entry.
9023	The crypto type specified in the LDAP request control is not supported.
9024	The username parameter is missing from the LDAP request control.

If the directory is able to compare verifiers, and the comparison evaluates as false, the directory sends the standard error `LDAP_COMPARE_FALSE` to the client. Similarly, if the user being authenticated lacks a directory entry, the directory sends the standard error `LDAP_NO_SUCH_OBJECT`.

See Also: "Password Verifier Schema Elements" in *Oracle Fusion Middleware Reference for Oracle Identity Management*

Troubleshooting Oracle Internet Directory Password Wallets

The Oracle Internet Directory Server has two password wallets: `oidpwdlldap1` and `oidpwdrSID`.

The `oidpwdlldap1` file contains the DN and password of an ODS user in encrypted format. The Oracle Internet Directory server uses the credential to connect to the back end database at startup time.

Oracle Internet Directory Server Does Not Start

Either `oidctl` or `opmn` fails to start an Oracle Internet Directory server instance.

Problem

The password stored in the `oidpwdlldap1` wallet is not synchronized with the ODS password in the back end database.

Solution

Try to connect to the database again using the `sqlplus` command:

```
sqlplus ods /ods_password@connect_string
```

If the connection succeeds, try to synchronize the password in the wallet with the ODS password by using the `oidpasswd` tool to create a new wallet with the correct password. For example, ensure that `ORACLE_INSTANCE` is set, then type:

```
>> oidpasswd connect=connect_string create_wallet=true
```

If the connection attempt fails, you must login into the back end database as a database administrator and change the ODS password by using the sql command:

```
>> alter user ods identified by some_new_password
```

Then try to create a new `oidpwdlldap1` to store the new password.

Solution

Try to start the Oracle Internet Directory server again.

The `oidpwdrSID` file contains the DN and password of a replica DN in an encrypted format. The Oracle Internet Directory replication server uses the credential to connect to the Oracle Internet Directory server at startup time.

This is an example of a replication password wallet, `oidpwdrSID`:

```
/-----BEGIN REPL CREDENTIAL:cn=replication dn,orclreplicaid=qdinh-sun_
adeldap,cn=replication configuration-----
ezNkZXMtY2JjLXBrY3M1cGFkQUnaz0Tsfzcp0nM1HcHAXchf5mJw+sb4y0bLvVw3RvSg7H
S7/WsKJB02fdSGRlmfWAV+6llkRQ26g==
-----END REPL CREDENTIAL:cn=replication dn,orclreplicaid=qdinh-sun_
adeldap,cn=replication configuration-----/
```

Password Not Synchronized

Either `oidctl` or `opmn` fails to start an Oracle Internet Directory server instance and the replication server log file `oidrepld00.log` reports that it is not able to bind.

Problem

The replica DN password stored in the `oidpwdrSID` is not synchronized with the replica DN password in the Oracle Internet Directory server.

Solution

Try to connect to the Oracle Internet Directory server instance using the `ldapbind` command. Specify the replica DN stored in `oidpwdrSID` and the replica DN password. For example:

```
>> ldapbind -h host -p port -D "cn=replication dn,orclreplicaid=qdinh-sun_adeldap,
cn=replication configuration" -q
```

If the connection succeeds, then you can reset the password in the `oidpwdrSID` wallet using `remtool` with the option `-pchgwalpwd`, which changes the password of the replication DN of a replica only in the wallet. If you do not remember the replication dn password, then you can reset it using `remtool` with the option `-prestpwd`, which resets the password of the replication dn of a replica.

After resetting the replication password wallet, restart the replication server instance again a using `opmnctl`.

Troubleshooting bulkload

Oracle highly recommends that you investigate and correct all errors thrown by `bulkload` before proceeding with the next step. If you ignore an `bulkload` error, you are likely to run into serious problems later.

To get more information about the reason for error, run the command with debug enabled (`debug=t`). Debug information is available in `ORACLE_INSTANCE/diagnostics/logs/OID/tools/bulkload.log` and in the database `ods.ds_ldap_log` table.

Most `bulkload` errors occur during data load or during index creation.

Problem

The `bulkload` command-line tool fails during data load.

Solution

Restore the directory to the state it was in before the data load by using one of these methods:

- Use the `bulkload recover` option
- Restore the database from a backup taken before you invoked `bulkload`.

Problem

The `bulkload` command-line tool fails during index creation.

Solution

Examine `bulkload.log`. Find and fix the specific issue that caused index creation failure. Run `bulkload` with the `index` option again.

Failure to correct index errors can cause duplicate entries or duplicate rows in the Oracle Internet Directory's tables.

Problem

The `bulkload` command-line tool fails because of a broken connection to the database. This can occur, for example, due to a host crash or in to a failover in Real Application Clusters.

Solution

Follow the following procedure:

1. Ensure that the database is restarted properly.
2. If the `bulkload` invocation employed only the `check="TRUE"` or `generate="TRUE"` options, but not the `load="TRUE"` option, go to step 3.

If it was the `bulkload load="TRUE"` option that failed, you must restore the database to its state before the failure. How you do that depends on whether you have a backup of the database before you issued the `bulkload load="TRUE"` command.

- If you have a backup, use it to restore the database to its original state before you issued the `bulkload` command.
 - If you do not have a backup, use the `bulkload recover` command to return the database to its state before the `bulkload load="TRUE"` command.
3. Re-issue the `bulkload` command that failed.

Troubleshooting bulkdelete, bulkmodify, and ldifwrite

Oracle highly recommends that you investigate and correct all errors thrown by the bulk tools before proceeding with the next step. To get more information about the reason for error, run the command with debug enabled (`debug=t`).

Debug information is available in the corresponding log file, `bulkdelete.log`, `bulkmodify.log`, or `ldifwrite.log`, under `ORACLE_INSTANCE/diagnostics/logs/OID/tools/`. In the database, debug information is available in the `ods.ds_ldap_log` table.

Problem

The `bulkdelete` or `bulkmodify` command-line tool fails because of a broken connection to the database. This can occur, for example, due to a host crash or in to a failover in Real Application Clusters.

Solution

Ensure that the database is restarted properly. Then retry the `bulkdelete` or `bulkmodify` command that failed.

Troubleshooting catalog

Oracle highly recommends that you investigate and correct all errors thrown by the bulk tools before proceeding with the next step. To get more information about the reason for error, run the command with debug enabled (`debug=t`).

Debug information is available in `ORACLE_INSTANCE/diagnostics/logs/OID/tools/catalog.log` and in database `ods.ds_ldap_log` table.

Problem

The `catalog` command-line tool fails because of a broken connection to the database. This can occur, for example, due to a host crash or in to a failover in Real Application Clusters.

Solution

Ensure that the database is restarted properly. Retry the `catalog` command that failed. If the original invocation employed the `add="TRUE"` option, the retry might fail because the first command partially completed. If the retry fails, use `catalog delete="TRUE"` to delete the attribute index, then retry the command again.

Problem

The `catalog` command throws an error because more than 1000 attributes are present in the file.

Solution

If you need to index more than 1000 attributes, use multiple files.

Troubleshooting remtool

Problem

A `remtool` query such as

```
remtool -pdispqstat -v -bind host:port
```

hangs. During the hang, attempts to bind to the server with other tools might fail.

Solution

If there is a large backlog of changelogs waiting to be purged, the `remtool` search query runs for a long time. Ensure that changelog purging is configured appropriately for your environment. See ["Change Log Purging"](#) on page 35-5.

You can also increase the number of worker threads so that other tools can bind while `remtool` is running the query. See ["Attributes of the Instance-Specific Configuration Entry"](#) on page 9-2 and the Oracle Internet Directory chapter in *Oracle Fusion Middleware Performance and Tuning Guide*.

Troubleshooting Server Chaining

Problem

The log contains the error message `Server Chaining error` followed by `javax.naming.AuthenticationException`.

Solution

In ODSM, go to the **Advanced** tab and expand **Server Chaining**. In each enabled entry, click **Verify Login Credential**, **Verify User Container**, and **Verify Group Container**.

If the verification fails, examine the values you entered for errors. If the problem persists, consult the external directory administrator to verify the accuracy of the values you entered.

Viewing Version Information

On the Oracle Directory Services Manager home page for Oracle Internet Directory, you can view version information about Oracle Directory Services Manager, Oracle Internet Directory, and the associated Oracle Database. For information about using Oracle Directory Services Manager, see ["Using Oracle Directory Services Manager"](#) on page 7-5.

Troubleshooting Fusion Middleware Control and WLST

Problem

Oracle Enterprise Manager Fusion Middleware Control and WLST do not work after the system is patched to 11g Release 1 (11.1.1.4.0).

Solution

This problem occurs if you had SSL server authentication enabled and cipher suites configured prior to patching. To fix this problem after patching, remove the `orclsslcpiphersuite` attribute from the instance-specific configuration entry by using `ldapmodify`. The LDIF file for deleting the `orclsslcpiphersuite` attribute in the instance-specific entry is:

```
dn: cn=componentname,cn=osldapd,cn=subconfigsentry
changetype: modify
delete: orclsslcpiphersuite
```

The command is:

```
ldapmodify -D cn=orcladmin -q -p portNum -h hostname -f ldifFile
```

Restart Oracle Internet Directory as described in ["Restarting the Oracle Internet Directory Server by Using opmnctl"](#) on page 8-10.

Problem

Oracle Internet Directory is up and running, but you cannot change Oracle Internet Directory parameters by using Oracle Enterprise Manager Fusion Middleware Control or WLST. You might see the error message: Unable to connect backend OID.

Solution

This can occur if the Oracle Internet Directory port number was changed and the server was not restarted or the Oracle Internet Directory component registration was not updated. Restart the server and run `opmnctl updatecomponentregistration`, as described in ["Updating the Component Registration of an Oracle Instance by Using opmnctl"](#) on page 8-8.

Solution

This occurs if you specify an SSL port configured for server authentication or mutual authentication when using the replication wizard. The replication wizard can only connect to SSL ports that are configured for no authentication. Always specify a non-SSL port or an SSL port configured for no authentication when prompted to log in or when specifying a node.

Solution

This occurs if Oracle Internet Directory's SSL port is configured for mutual authentication. Oracle Enterprise Manager Fusion Middleware Control and WLST manage Oracle Internet Directory through the SSL port, and the port must be configured for no authentication or server authentication.

See Also: ["SSL Authentication Modes"](#) on page 26-3.

Troubleshooting Oracle Directory Services Manager

This section lists issues related to Oracle Directory Services Manager.

Cannot Invoke ODSM from Fusion Middleware Control

Problem

You attempt to invoke Oracle Directory Services Manager from Oracle Enterprise Manager Fusion Middleware Control by selecting **Directory Services Manager** from the Oracle Internet Directory menu in the Oracle Internet Directory target, then **Data Browser**, **Schema**, **Security**, or **Advanced**.

ODSM does not open. You might see an error message.

Solution

This is probably an installation problem. See *Oracle Fusion Middleware Installation Guide for Oracle Identity Management*.

Cannot Invoke ODSM from Fusion Middleware Control in Multiple NIC and DHCP Enabled Environment

Problem

The WebLogic Managed Server where Oracle Directory Services Manager is deployed has multiple Network Interface Cards (NIC) or is DHCP enabled. Attempts to invoke Oracle Directory Services Manager from Oracle Enterprise Manager Fusion Middleware Control fail and return 404 errors.

Solution

Use the WebLogic Server Administration Console to change the listen address of the Managed WebLogic Server so that the IP address or hostname in the URL for Oracle Directory Services Manager is accessible.

Perform the following steps:

1. Using a web browser, access the WebLogic Server Administration Console.
2. In the left pane of the WebLogic Server Administration Console, click **Lock & Edit** to edit the server configuration.
3. In the left pane of the WebLogic Server Administration Console, expand **Environment** and select **Servers**.
4. On the Summary of Servers page, click the link for the WebLogic Managed Server where Oracle Directory Services Manager is deployed.
5. On the Settings page for the WebLogic Managed Server, update the Listen Address to the host name of the server where Oracle Directory Services Manager is deployed.
6. Click **Save** to save the configuration.
7. Click **Activate Changes** to update the server configuration.

Various Failover Issues

Problem

When you perform an Oracle Directory Services Manager failover using Oracle HTTP Server, the failover is not transparent. You see this behavior when you perform the following steps:

1. Oracle Directory Services Manager is deployed in a High Availability active-active configuration using Oracle HTTP Server.
2. Display an Oracle Directory Services Manager page using the Oracle HTTP Server name and port number.
3. Make a connection to an Oracle Internet Directory server.
4. Work with the Oracle Internet Directory server using the current Oracle Directory Services Manager Oracle HTTP Server host and port.
5. Shut down one managed server at a time using the WebLogic Server Administration Console.
6. Go back to the Oracle Directory Services Manager page and port, and the connection which was established earlier with Oracle Internet Directory. When you do, a message is displayed advising you to re-establish a new connection to the Oracle Directory Services Manager page.

Solution

If you encounter this problem, perform the following steps:

1. In your web browser, exit the current Oracle Directory Services Manager page.
2. Launch a new web browser page and specify the same Oracle Directory Services Manager Oracle HTTP Server name and port.
3. Re-establish a new connection to the Oracle Internet Directory server you were working with earlier.

See Also:

- *The Oracle Fusion Middleware High Availability Guide* for more information about Oracle Directory Services Manager in High Availability configurations.
 - ["Configuring Oracle HTTP Server to Support Oracle Directory Services Manager in an Oracle WebLogic Server Cluster"](#) on page 7-12
-
-

Problem

ODSM temporarily loses its connection to Oracle Internet Directory and displays the message `LDAP Server is down`.

Solution

In a High Availability configuration where ODSM is connected to Oracle Internet Directory through a load balancer, ODSM reports that the server is down during failover from one instance of Oracle Internet Directory to another. In other configurations, this message might indicate that Oracle Internet Directory has been shut down and restarted. In either case, the connection is reestablished in less than a minute, and you are able to continue without logging in again.

Problem

ODSM temporarily loses its connection to an Oracle Internet Directory instance that is using an Oracle RAC database. ODSM might display the message `Failure accessing Oracle database (oracle errcode=errcode)`, where `errcode` is one of the following values: 3113, 3114, 1092, 28, 1041, or 1012.

Solution

This error can occur during failover of the Oracle Database that the Oracle Internet Directory instance is using. The connection is reestablished in less than a minute, and you are able to continue without logging in again.

ODSM Displays an Error Message**Problem**

ODSM displays the error message: `Error :Posn: -1, Size: 0`

Solution

This error can be ignored. It usually indicates that Oracle Internet Directory has detected an error in an ODSM operation. JNDI, which ODSM uses to connect to Oracle Internet Directory, sometimes returns this error code instead of the actual error code. Oracle Internet Directory server log files show a more meaningful error message.

Cursor Loses Focus

Problem

When you access ODSM in accessibility mode, using only the keyboard, in Internet Explorer 7, the cursor loses focus. This behavior has been observed under the following circumstances:

- You access the directory in SSL-enabled mode and the server certificate appears.
- You type an invalid password and the error dialog appears.

Solution

Press the Tab key nine times, then press the Enter key.

Need More Help?

You can find more solutions on My Oracle Support (formerly MetaLink), <http://metalink.oracle.com>. If you do not find a solution for your problem, log a service request.

See Also: *Oracle Fusion Middleware Release Notes for Microsoft Windows (32-Bit)*, available on the Oracle Technology Network:
<http://www.oracle.com/technology/documentation/index.html>

Symbols

+ in search request, 13-11

Numerics

3DES value of orclpwdverifierparams
generating dynamic verifiers, 30-11

A

abstract object classes, 3-13

superclasses of, 20-4

top, 3-12

access

exclusionary, 29-15

granting

by using ODSM, 29-15

entry-level, by using ODSM data

browser, 29-21

kinds, 29-10

level requirements for LDAP operations, 29-11

operations, 29-10

read-only

granting by using ldapmodify

command, 29-25

rights, setting by using ODSM access

control, 29-18, 29-19

selecting, by DN

by using ldapmodify command, 29-24

subject, 29-8

unspecified, 29-11

access control, 29-1 to 29-26

and authorization, 3-15

bind IP filter, 29-8

conceptual discussion, 29-1

default, 31-3

defined, 3-15

directive format. See ACI directive format

information, described, 29-1

information, format and syntax, H-1

management constructs, 29-2

managing, 29-1

by using command-line tools, 29-22

by using ODSM, 29-15

policies

conflicting, 29-3

inheriting, 29-3

policy administration, introduction, 29-1

prescriptive, 29-3

setting by using wildcards, 29-23

access control lists, 3-7

See also ACLs

access control policy points

defined, 3-5

groups, 29-4

See also ACPs

account lockout

enforced by password policies, 28-4

accounts

disabling, 12-2

enabling and disabling

by using command-line tools, 12-2

by using Oracle Internet Directory Self-Service

Console, 12-4

managing, 12-1

privileged, 12-2

unlocking

by using command-line tools, 12-3

by using Oracle Internet Directory Self-Service

Console, 12-4

realm administrator, 33-7

superuser, 28-4

ACIs

components, 29-7

content, 29-1

defined, 29-1

entry level

setting up by using ldapmodify

command, 29-23

more than one for the same subject, 29-14

object of directives, 29-7

representation, 29-2

restricting kinds users can add, 29-22

See access control items

subject of directives, 29-8

ACL evaluation

how it works, 29-12

ACLs

directives, within entries, 29-3

for groups, 29-15

precedence rules, 29-12

- See access control lists
 - within subtrees, 29-3
- ACPs
 - adding
 - by using ldapmodify command, 29-23
 - by using ODSM access control, 29-16
 - by using ODSM Data Browser, 29-21
 - defined, 29-2
 - groups, 29-4
 - modifying
 - by using ODSM access control, 29-20
 - by using ODSM Data Browser, 29-21
 - multiple, 29-3
 - See also access control policy points
 - viewing
 - by using ODSM access control, 29-15
- activate replication, 40-13, 41-12, 41-21
- active server instances
 - viewing, 8-5
 - by using opmnctl command, 8-9
- added_object_constraint filter, 29-22
- added-object-constraint, in access control, 29-10
- adding attributes
 - by using ldapmodify command, 20-20
- adding attributes to object classes by using ldapmodify command, 20-19
- adding indexes by using ODSM, 20-15
- adding object classes
 - by using ODSM, 20-11
- adding object classes by using ldapmodify command, 20-18
- addresses
 - IP, 10-1
- Advanced Replication
 - adding a new node for, C-11
 - architecture, D-2
 - change logs, D-4
 - configuring
 - by using Replication Management Tool, C-6
 - sqlnet.ora, C-6
 - tnsnames.ora, C-6
 - deleting a node, C-14
 - Directory Replication Group, C-3
 - DRG, C-3
 - filtering, C-1
 - installing and configuring, C-2, C-4
 - nodes
 - adding, C-11
 - deleting, C-14
 - preparing the Oracle Net Services environment for, C-6
 - replication groups (DRGs), C-4
 - configuring, C-4
- Advanced Replication groups
 - setting up, C-4
- AL32UTF8 character set, R-2, R-3
- alias entries, 17-1 to 17-6
 - adding by using ldapadd command, 17-2
 - defined, 17-1
 - dereferencing, 17-1
 - messages, 17-6
 - modifying by using ldapmodify command, 17-6
 - searching directory with, 17-3
- aliases
 - attributes with
 - adding by using ldapmodify command, 20-21
- alphabetic characters
 - password policy attribute, 28-6
- anonymous authentication, 32-1
- anonymous binds, 9-12
 - default behavior, 32-8
 - limited operations on root DSE, 32-8
 - managing
 - by using Fusion Middleware Control, 32-8
 - by using ldapmodify command, 32-8
- application-specific repositories
 - migrating data from, 36-6
- apply threads per supplier, 40-13
- architecture
 - Oracle Internet Directory, 1-4, 3-1
 - Oracle Internet Directory Server Manageability framework, 24-2
- attribute aliases, 20-10
 - delete by using ldapmodify command, 20-22
 - using with ldapadd, 20-24
 - using with ldapdelete, 20-25
 - using with ldapmoddn, 20-25
 - using with ldapmodify, 20-24
 - using with ldapadd, 20-24
 - using with ldapsearch, 20-23
- attribute mapping
 - in server chaining, 37-8
- attribute name in search request
 - case, 9-12
- attribute options, 3-11
 - adding
 - by using ldapmodify, 13-13
 - conceptual discussion, 3-11
 - deleting by using ODSM, 13-13
 - language codes, 3-11
 - searching for by using ldapsearch, 13-13
- attribute selectors, 29-24
- attribute uniqueness
 - defined, 18-1
 - rules for creating, 18-3
- attribute uniqueness constraint
 - example, 18-8
- attribute uniqueness constraint entries, 18-1 to 18-9
 - DN, 18-2
- attribute uniqueness constraints
 - creating by using ldapadd, 18-9
 - deleting by using ldapdelete, 18-9
 - modifying by using ldapmodify, 18-9
- attribute values not preserved on upgrade to 11g, A-4
- attributes
 - adding, 20-5
 - by using ldapmodify command, 20-19, 20-20, 20-22
 - adding index by using ldapmodify

- command, 20-20
- as metadata in schema, 20-2
- attribute options, 13-13
 - adding by using ldapmodify, 13-13
 - conceptual discussion, 3-11
 - deleting by using ODSM, 13-13
- base schema
 - deleting, 20-5
 - modifying, 20-5
- change logs, 41-16
- collective, 16-1
- commonName, 3-10
- configuration
 - automatically created, 3-9
 - defined, 9-1
 - managing by using WLST, 9-14
- content rules, 20-9
- defined, 3-8
- deleting, 20-5
 - by using ODSM, 20-14
- determined by object classes, 20-2
- ditcontentrule, 20-8
- dropping indexes, 20-16
- extending number of
 - by using auxiliary object classes, 20-7
 - by using content rules, 20-8
 - for existing entries, 20-7
 - prior to creating entries, 20-7
- for a specific entry
 - viewing by using ODSM, 13-5
- for which data exists
 - indexing, 20-21
- for which no directory data exists
 - indexing, 20-20
- hashed, 9-13
- in base schema, 20-5
- in Fusion Middleware Control replication wizard, 40-13
- in top object class, 3-13
- indexed, 3-6
- indexes, created by bulkload, 15-7
- indexing, 20-21
 - by using catalog command, 20-6
- information, kinds of, 3-9
- inheritance of, 20-3
- instance-specific
 - managing by using Fusion Middleware Control, 9-11
- jpegPhotos, 3-10, 13-12
- kinds of information in, 3-9
- labeledURI, 14-4, 14-5, 14-6, 14-15
- listing
 - by using ldapsearch, 13-11
- managing
 - by using Fusion Middleware Control, 9-11
- mandatory, 3-12, 20-3, 20-12
 - in a user entry, 36-9
- matching rules, 3-11
- modifying
 - by using ldapmodify, 20-19
 - by using ODSM, 20-14
 - rules for, 20-5
 - using ldapmodify command, 20-22
- multivalued
 - converting to single-valued, 20-5
- null values in, 20-3
- objects associated with an ACL, 29-7
- of the DSA configuration entry, 9-9
- of the DSE, 9-10
- of the instance-specific configuration entry, 9-2
- optional, 3-12, 20-3
- options, 3-11
 - language codes., 3-11
- organization, 3-10
- organizationalUnitName, 3-10
- redefining mandatory, 20-4
- ref, 19-1
- removing from object classes, 20-4
- replication configuration container, 40-1
- searchable, 15-12
- searching
 - by using ODSM, 20-15
- single-valued, 3-10
 - converting to multivalued, 20-5
- skewed, 9-13
- specifying as mandatory or optional, 20-3
- storing password verifiers
 - for authenticating to Oracle components, 30-5
- syntax, 3-11
 - modifying, 20-5
- syntax type
 - selecting, 20-17
- syntaxes
 - cannot modify, 20-5
 - selecting, 20-17
- system operational, 9-1
- types, 3-9
- user entry, 12-2
- usercertificate, K-1
- values, 3-9
- viewing, 13-5
- with aliases
 - adding by using ldapmodify command, 20-21
- audit
 - attributes, 22-2
 - events and categories, 22-2
 - users to always, 22-4
- audit configuration
 - viewing
 - by using ldapsearch command, 22-5
- audit framework
 - advantages, 22-2
 - features, 22-1
- audit policy, 22-4
- audit policy page
 - in Fusion Middleware Control, 22-4
- audit presets, 22-2
- audit record pathname, 22-3
- audit record storage, 22-3
- audit records, 22-3

- audit, 10g versus 11g, A-7
- auditing, 22-1 to 22-6
 - administrator, 22-2
 - defined, 22-1
 - managing
 - by using Fusion Middleware Control, 22-4
 - by using ldapmodify command, 22-6
 - managing by using WLST, 22-5
- auditing Oracle Directory Integration Platform, 22-3
- auditing replication, 22-3
- authentication, 32-1 to 32-9
 - anonymous, 32-1
 - at ldapbind, 32-1
 - certificate, 32-2
 - conceptual discussion, 32-1
 - defined, 3-15
 - direct
 - options, 32-1
 - external, 32-4, 44-1
 - SASL, 32-2
 - in a typical directory operation, 3-7
 - indirect, 32-3
 - through a RADIUS server, 32-3
 - modes, SSL
 - testing, 26-12
 - native, 44-1
 - Oracle directory replication server, 38-6
 - password-based, 32-1
 - PKI, 26-2
 - SASL, 32-1
 - SASL mechanism
 - external authentication, 32-2
 - MD5 Digest, 32-2
 - simple, 32-1
 - Simple Authentication and Security Layer (SASL), 32-1
 - SSL
 - defined, 32-1
 - three levels, 1-6
 - through a middle tier, 32-3
- authentication of replication server, 38-6
- Authentication Services Group, 31-12
- authorization, 3-15
 - defined, 29-1
- automated resolution of conflicts, 41-6
- autotune replication, 40-13, 41-2, 41-11, 41-21
- auxiliary object classes, 3-13, 20-4
 - extending number of attributes by using, 20-7

B

- backing up data
 - before setting up replication, 38-18
- backup and restore, 25-1
- base schema
 - attributes, 20-5
 - deleting, 20-5
 - modifying, 20-5
 - object classes
 - modifying, 20-4

- base search, 13-4
- basic management tasks, 7-15
- binary values
 - printing by using ldapsearch command, 13-14
- bind IP filter, 29-8, 29-9
- bind mode, 29-9
- bind operation
 - when authentication occurs, 32-1
- bind performance monitoring garbage collectors, 35-3
- binding, 3-7
- binds
 - anonymous, 9-12
- bootstrap
 - setting up by using command line, 38-19
 - setting up by using replication wizard, 38-3
 - troubleshooting, R-21
- bootstrap capability of the replication server, 38-3
- bootstrap rules, 38-3
- bulk tools, 15-1 to 15-12
 - environment variables required, 15-1
 - troubleshooting, R-28
- bulkdelete command, 15-9
 - deleting naming contexts
 - replication setup, 38-27
 - Globalization Support, I-8
 - log file location, 23-1
 - log file name, 23-1
 - replication setup
 - deleting naming contexts, 38-27
 - syntax, 15-10
- bulkload
 - load command
 - option, 15-7
- bulkload command, 15-6, 15-7
 - check mode, performing on LDIF files, 36-4
 - creating indexes, 15-7
 - Globalization Support, I-8
 - loading data
 - replication setup, 38-27
 - loading data into schema, 15-3
 - log file location, 23-1
 - log file name, 23-1
 - migrating third party LDAP data, 36-5
 - replication setup
 - loading data, 38-27
 - syntax, 15-5
 - troubleshooting, R-26
- bulkmodify command, 15-8
 - Globalization Support, I-9
 - log file location, 23-1
 - log file name, 23-1
 - syntax, 15-9

C

- cache
 - metadata, 3-4
- cached and uncached groups, 14-2
- caches

- entry
 - tuning, 9-12
 - privilege group membership
 - tuning, 9-12
- case of attribute name in search request, 9-12
- catalog
 - limit on number of attributes, R-28
- catalog command, 20-21
 - creating indexes, 15-11
 - log file location, 23-1
 - log file name, 23-1
 - referential integrity
 - enabling, 21-3
 - syntax, 15-12
 - troubleshooting, R-28
- catalog entry, 3-6
- Catalog Management Tool
 - See catalog command
- certificate authentication, 32-2
- certificates
 - in wallet, 26-4
- change log entries
 - on ODSM home page, 24-7
- change logs
 - and directory replication, 41-3
 - attributes, 41-16
 - change number-based purging, 35-5
 - DNs, 35-5
 - enable or disable generation
 - tuning, 9-12
 - garbage collection
 - troubleshooting, R-24
 - garbage collector, 35-2
 - in Advanced Replication, D-4
 - in replication, 41-3
 - managing generation, 41-15
 - managing generation by using Fusion Middleware Control, 41-7
 - purging, 35-5
 - configuring by using ldapmodify command, 35-9
 - methods, 35-5
 - purging, in multimaster replication, 35-5
 - time-based purging, 35-5
 - viewing by using ldapsearch command, 41-15
 - viewing by using ODSM, 41-8
- change number-based purging, 35-5
- change retry count, 41-21
 - replication, 40-13
- change retry counts, 41-11
- cipher suites
 - SSL, 26-2
 - SSL, supported, 26-2
 - supported in SSL, 26-2
- cn entry attribute, 3-10
 - adding, 13-12
- cn=oraclecontext naming context
 - replication setup, 38-32
- cn=pwdpolicies container in realm, 28-2
- cn=replication namecontext, 40-6
- cold failover cluster
 - configuring IP address, 10-1
- cold failover clusters
 - IP addresses, 10-1
- collective attribute
 - managing, 16-4
 - overriding, 16-4
- collective attributes, 16-1
- command-line tools, 7-13 to 7-14
 - 10g versus 11g, A-6
 - Catalog Management Tool, 20-6
 - indexing, 20-6, 20-21
 - managing entries, 13-11
 - overview, 7-13
 - setting Globalization Support, I-5
- common entry, defined, 3-6
- Common Group Attributes Group, 31-14
- Common User Attributes Group, 31-14
- commonName attribute, 3-10
- compare failure performance monitoring garbage collectors, 35-3
- components
 - of a directory server, 3-2
 - of Oracle Internet Directory, 1-5
- compound RDNs
 - oidcmprec limitations, 41-34
- configuration attributes, 9-1 to 9-18
 - 10g versus 11g, A-3
 - automatically created, 3-9
 - defined, 9-1
 - listing by using ldapsearch command, 9-17
 - managing
 - by using ODSM, 9-18
 - by using WLST, 9-14
 - setting by using ldapmodify command, 9-16
- configuration files, 10g versus 11g, A-7
- configuration information, 10g versus 11g, A-3
- conflict resolution
 - automatic, 41-6
 - in replication, 41-4
 - messages, 41-23
 - command-line monitoring, 41-22
 - monitoring by using Fusion Middleware Control, 41-14
- conflicting access control policies, 29-3
 - precedence, rules for resolving, 29-3
- conflicts, replication
 - automated resolution of, 41-6
 - manual resolution of, 41-24
 - resolution, 29-12, 41-4
 - resolving manually, 41-24
 - typical causes of, 41-5
- CONNECT_BY assertions and dynamic groups, 14-4, 14-5
- connecting
 - to a directory server, 3-6
- connection timeout
 - tuning, 9-12
- connection to Oracle Database down, R-2
- connections

- on ODSM home page, 24-7
- connections to database
 - tuning, 9-12
- connections, pooling, 1-6
- constraints, object classes, 3-13
- consumers, defined, 6-4
- containment
 - of groups, planning, 5-3
 - of users, planning, 5-3
- content rules
 - adding
 - by using `ldapmodify` command, 20-25
 - defined, 20-8
 - defined as values of `ditcontentrule` attribute, 20-8
 - extending number of attributes by using, 20-8
 - format, 20-25
 - managing
 - by using command-line tools, 20-25
 - modifying
 - by using ODSM, 20-16
 - parameters, 20-26
 - rules for creating and modifying, 20-8
 - schema enforcement when using, 20-9
- controls
 - definition, 1-3
- converting
 - auxiliary object classes, 20-4
 - structural object classes, 20-4
- `createTimestamp` attribute, 3-10, 36-3
 - optional in top, 3-13
- creating an instance, 10g versus 11g, A-1
- creating content rules
 - by using ODSM, 20-16
- creating content rules by using ODSM, 20-16
- creating dynamic groups
 - by using ODSM, 14-10
- creating static groups
 - by using ODSM, 14-8
- `creatorsName` attribute, 3-10, 36-3
 - optional attribute in top, 3-13
- critical events
 - in Oracle Internet Directory Server Manageability framework, 24-9
 - levels, 24-9
- customized settings
 - LDAP replication setup, 38-18

D

- data migration from other repositories, 36-1 to 36-9
- data migration process, 36-1
- data privacy, 3-15, 27-1 to ??, 27-7, ?? to 27-7, ?? to 27-8
- database
 - connections
 - pooling, 1-6
 - tuning, 9-12
 - dedicated for directory, 3-3
 - errors, R-2
 - password, changing, 12-6

- server, 1-4
- server error, R-2, R-3
- server performance
 - troubleshooting, R-11
- database account ODSSM
 - accessing server manageability information, 24-4
- Database Vault
 - best practices, 27-5
 - configuration for Oracle Internet Directory, 27-5
 - deleting policies, 27-5
 - disabling, 27-5
 - policies for protecting Oracle Internet Directory, 27-4
- databases used by Oracle Internet Directory
 - tablespace encryption
 - enabling or disabling, 27-1
- `dc` attribute, 3-10
- debug
 - on ODSM home page, 24-7
- debug logging levels, 23-5
 - about, 23-2
 - replication server, 40-13, 41-11, 41-21
 - configuring by using Fusion Middleware Control, 41-12
 - setting by using ODSM, 23-5
 - setting by using OID Control Utility, 23-6
 - setting by using the command line, 23-6
- debug operations, 23-7
 - enabled, 23-5
 - setting
 - by using `ldapmodify` command, 23-8
- debug, enabling, 10g versus 11g, A-6
- debugging LDAP operations, 23-7
- debugging the external authentication plug-in, 44-3
- debugging, limiting to specific operations, 23-7
- default configuration
 - access controls, 31-3
- default identity management realm, 3-23, 33-6
- default knowledge references (referrals)
 - configuring, 19-4
- default password policy, 28-4
- default ports, 3-4
 - 10g versus 11g, A-5
- default URLs and ports
 - list of commonly-used, 7-2
- Delegated Administration Services
 - defined, 3-19
 - self-service console, 12-4
 - delegating privileges, 31-1 to 31-14
 - delegating privileges for user and group management, 31-3
- deleting a replica
 - command-line, 38-29
- deleting attributes by using ODSM, 20-14
- deleting object classes by using ODSM, 20-13
- dereferencing alias entries, 17-1
- differences between 10g and 11g, A-1 to A-9
- Digest, MD5, 32-2
- `digest-md5` attribute, 41-11
- directories

- application, migrating data from, 36-6
- backup and restore, 25-1
- contrasted to relational databases, 1-2
- database listener, C-7
- defined, 1-1
- distributed, 3-16
- existing, default directory structure, 36-1
- expanding role of, 1-1
- location-independent, 1-2
- online
 - expanding role of, 1-1
- partitioned, 3-16
- planning structure of, 5-2
- schema
 - managing, 20-1
 - overview, 20-1
- small
 - backing up and restoring, 25-1
 - special purpose, 1-2
 - under the Oracle instance, 2-4
- directory attributes
 - view all by using ODSM, 20-15
- directory concepts and architecture, 3-1 to 3-26
- directory entries, managing, 13-1 to 13-14
- directory information tree (DIT), 3-7
 - default, 33-6
 - defined, 3-7
 - planning, 5-1
 - planning for identity management, 5-1
- directory metadata
 - defined, 3-4
- directory organization, 5-1 to 5-5
- directory replication group (DRG) type, 6-4
- directory replication server, 1-5, 3-3
 - authentication, 38-6
 - log file location, 23-1
- directory schema, 20-2
 - defined, 3-5
 - managing, 20-1
- directory servers, 1-5, 3-3
 - connecting to, 3-6
 - log file location, 23-2
 - managing instances, 8-1
 - processes
 - multiple, 3-4
 - shared server, 1-6
 - supported by server chaining, 37-2
 - viewing information, 8-5, 8-9
- disabling accounts, 12-2
- disallowed password values
 - password policy attribute, 28-6
- dispatcher
 - maximum server response time, 9-12
- dispatcher process, 3-3, 8-3
- dispatcher threads
 - number
 - tuning, 9-12
- displaying entries
 - by using ODSM, 13-2
- distinguished names, 3-7
 - components of, 3-8
 - defined, 3-7
 - format, 3-8
- distributed directories, 3-16
 - partitioned, 3-16
 - replicated, 3-16
- ditcontentrule attribute, 20-8
- DITContentRule subschemasubentry attribute, 20-8
- DN
 - match, 9-13
 - See also distinguished names
 - user, 9-13
- DSA configuration entry
 - attributes, 9-9, 9-10
 - defined, 9-10
 - DN, 9-9
 - navigating to in ODSM, 9-18
- DSE root
 - navigating to in ODSM, 9-18
- dual mode
 - SSL, 26-4
- dumping entries by using ldifwrite, 15-10
- duration of a search, specifying, 13-4
- dynamic groups, 14-2
 - cached and uncached, 14-2
 - creating
 - by using ldapadd, 14-15
 - by using ODSM, 14-10
 - modifying
 - by using ldapmodify command, 14-16
 - by using ODSM, 14-13
 - refreshing, 14-3
 - schema elements for creating, 14-4
- dynamic password verifiers
 - described, 30-10
 - generating, 30-11
 - troubleshooting, R-25

E

- E argument in Globalization Support, I-6
- EM
 - See Fusion Middleware Control
- EMD administrator account
 - password
 - changing by using WLST, 12-7
- enabling debug, 10g versus 11g, A-6
- encryption
 - of sensitive attributes, 27-6
 - passwords
 - UNIX crypt, 30-3, 30-4
- Enterprise Manager
 - See Fusion Middleware Control
- Enterprise User Security
 - server chaining
 - plug-in for password change notification, 37-14
 - SSL needs, 26-4
 - with server chaining, 37-1
- entity component, in access control, 29-8

- entries
 - adding
 - by copying an existing entry, 13-8
 - by using ODSM, 13-6
 - requires write access to parents, 13-6
 - adding by using ldapmodify, 13-13
 - attributes, viewing, 13-5
 - catalog, defined, 3-6
 - common, defined, 3-6
 - conceptual discussion, 3-7
 - displaying
 - by using ODSM, 13-2
 - distinguished names of, 3-7
 - garbage collector, 35-5
 - inheriting attributes, 20-3
 - loading, 20-3
 - locating by using distinguished names, 3-8
 - managing
 - by using bulk tools, 15-1
 - by using command line tools, 13-11
 - by using command-line tools, 13-11
 - by using ODSM, 13-1
 - modifying
 - by using ODSM, 13-9
 - naming, 3-7
 - objects associated with an ACI, 29-7
 - parent, 20-3
 - password policy, defined, 3-6
 - password verifier, defined, 3-6
 - plug-in, defined, 3-6
 - replication naming context container, 40-6
 - restricting the kinds users can add, 29-17, 29-22
 - returned by a search
 - maximum number, 9-12
 - searching
 - base level, 13-4
 - by using ODSM, 13-3
 - one-level, 13-4
 - specifying search depth, 13-4
 - subtree level, 13-4
 - selecting by DN
 - by using ldapmodify command, 29-24
 - static group
 - modifying, by using ldapmodify command, 14-14
 - statistics collector, 35-5
 - user
 - adding, by using ldapadd, 13-12
 - modifying, 13-13
 - modifying, by using ldapmodify, 13-13
 - with attribute options
 - deleting by using ODSM, 13-13
 - searching for by using ldapsearch, 13-13
- entry cache
 - defined, 3-8
 - tuning, 9-12
- entry-level access
 - granting
 - by using ODSM, 29-21
 - modifying
 - by using ODSM data browser, 29-21
 - setting
 - by using ODSM data browser, 29-21
- environment variables
 - required for bulk tools, 15-1
 - when using command-line tools, 7-13
- environment variables, NLS_LANG, 1-3
- error messages, R-5
 - 30SendPort, R-2
 - additional, R-5
 - administration, R-3
 - alias entries, 17-6
 - constraint violation, R-3
 - database server, R-2, R-3
 - directory server, due to interrupted client connection, R-2
 - directory server, due to schema modifications, R-3
 - installation, R-2
 - ORA-01483, R-3
 - ORA-1562, R-3
 - ORA-3113, R-2
 - ORA-3114, R-2
 - password policies, R-9
 - returned from Oracle directory server, R-4
 - sgslunrRead, R-2
 - standard, R-4
- event tracking
 - security
 - configuring by using ldapmodify command, 24-8
- exclusionary access to objects, granting, 29-15
- existing ACPs and their ACI directives, modifying
 - by using ODSM access control, 29-20
- existing attributes
 - modifying aliases in
 - by using ldapmodify, 20-22
- expiration warning messages
 - password policy attribute, 28-6
- expiry warning
 - password policies, 28-4
- explicit hierarchies, 14-6
- extensibility, in LDAP Version 3, 1-3
- extensibleObject object class, 19-1
- external authentication, 32-4
 - contrasted with native authentication, 44-1
 - defined, 44-1
 - plug-in, 44-1
 - debugging, 44-3
 - installing, 44-1, 44-3
 - installing, configuring, and enabling, 44-2
 - SASL authentication mechanism, 32-2
- external repository, storing security credentials
 - in, 44-1

F

- failed login attempts
 - operational attribute, 28-7
- failover, 1-6

- failure tolerance, and replication, 6-2
- fan-out replication, 6-5
 - described, 38-6
 - example of configuration objects, 40-9
 - groups, 6-5
 - with multimaster replication groups, 6-7
 - LDAP-based, 3-16
 - setup, 38-30
- features, new
 - release 11g (11.1.1), xlii
 - release 11g (11.1.1.4.0), xli
- file names
 - log files, 23-1
- filters
 - in searches, 3-6
 - maximum size, 9-13
 - search processed in memory, 9-13
- force flushing trace information, 23-8
- framework
 - server manageability, 24-1
- full replication, 6-3
- function calls, tracing, 23-7
- Fusion Middleware Control
 - activating replication, 41-11
 - as a component of Oracle Internet Directory server manageability, 24-4
 - changing superuser password, 12-5
 - configuring a user for statistics collection, 24-5
 - configuring certificate authentication method, 32-6
 - configuring logging, 23-5
 - configuring replica details, 41-12
 - configuring replication attributes, 40-12, 41-11
 - configuring replication debug level, 41-12
 - configuring SASL authentication, 32-6
 - configuring server statistics collection, 24-4
 - configuring SSL, 26-5
 - configuring SSL parameters, 26-7
 - connecting, 7-4
 - creating a wallet, 26-6
 - deactivating replication, 41-11
 - default port, 7-2
 - defined, 2-4
 - deleting replication agreements, 41-10
 - described, 2-4
 - enabling or disabling change log generation, 41-7
 - enabling referential integrity, 21-2
 - General tab of Server Properties page, 9-13
 - home page
 - statistics information, 24-6
 - human intervention queue, 41-13
 - invoking ODSM from, 7-9
 - log files
 - viewing, 23-5
 - logging
 - configuring, 23-5
 - managing and monitoring replication, 41-7
 - managing anonymous binds, 32-8
 - managing auditing, 22-4
 - managing configuration attributes, 9-11
 - managing logging, 23-4
 - managing Oracle Internet Directory, 7-4
 - managing Oracle Internet Directory components, 8-4
 - managing replica naming context objects, 41-8
 - managing Server Properties, 9-11
 - managing worker threads, 41-2
 - menus, 7-4
 - metrics, 24-6
 - monitoring conflict resolution, 41-14
 - oidmon interprets, 3-3
 - performance summary, 24-6
 - process status available to, 4-5
 - replication configuration, 40-12
 - replication wizard
 - bootstrap capability, 38-3
 - restarting the directory server, 8-5
 - server properties page, 9-11
 - setting server mode, 15-3
 - setting SSL parameters, 26-8
 - setting up statistics collection, 24-4
 - shared properties page, replication tab, 41-11
 - shared properties, replication tab, 40-12
 - starting the directory server, 8-5
 - statistics on Oracle Internet Directory home page, 24-6
 - troubleshooting, R-29
 - URL, 7-4
 - viewing active server information, 8-5
 - viewing log files, 23-5
 - viewing or modifying replication setup, 41-9
 - viewing queue statistics, 41-13
 - viewing statistics information, 24-6
- Fusion Middleware Control replication wizard
 - configuration attributes, 40-13
 - replication setup, 38-16
 - setup, 38-16 to 38-17
- Fusion Middleware Control, introduction, 7-4 to 7-5
- Fusion Middleware Home
 - defined, 2-3

G

- garbage collection, 35-1 to 35-10
 - database patch needed, R-24
 - framework
 - about, 35-1
 - components of, 35-1
 - how it works, 35-4
 - in replication, 35-5
 - plug-in, 35-1
 - garbage collection log monitoring, 35-9
 - garbage collectors
 - bind performance monitoring, 35-3
 - change log, 35-2
 - definition, 35-2
 - DN, 35-5
 - entries for, 35-5
 - general statistics, 35-2

- health statistics, 35-2
- LDAP compare performance monitoring, 35-3
- LDAP performance monitoring, 35-3
- managing, 35-7
- modifying
 - by using ldapmodify command, 35-7
 - by using ODSM, 35-7
- predefined, 35-2
- security and refresh events, 35-2
- system resource events, 35-3
- tombstone, 35-3
- general statistics garbage collector, 35-2
- generate stack dump, 41-21
- Globalization Support, 3-15, 3-16, I-1 to ??
 - Bulk Tools, I-8
 - bulkdelete command, I-8
 - bulkload command, I-8
 - bulkmodify command, I-9
 - command-line tools, I-5
 - ldapadd command, I-7
 - ldapaddmt command, I-7
 - ldapbind, I-7
 - ldapcompare command, I-7
 - ldapdelete command, I-7
 - ldapmoddn command, I-7
 - ldapmodify command, I-7
 - ldapmodifymt command, I-7
 - ldapsearch command, I-7
 - LDIF Files, I-4
 - ldifwrite command, I-8
 - managing, I-1
 - settings for Oracle Internet Directory, I-3
- grace logins
 - enforced by password policies, 28-4
 - password policy attribute, 28-6
- grace period
 - operational attribute, 28-7
- graphical user interfaces, 10g versus 11g, A-7
- group entries
 - creating
 - by using ODSM, 14-8, 14-11
- groupOfNames object class, 14-2, 14-8, 14-9, 14-10, 14-11
- groupOfUniqueNames object class, 14-2, 14-8, 14-11
- groups, 14-1 to 14-16
 - ACL evaluation for, 29-15
 - ACPs, 29-4
 - creating
 - by using ODSM, 14-10
 - dynamic, 14-2
 - creating by using ldapadd, 14-15
 - refresh, 14-3
 - schema elements for creating, 14-4
 - dynamic and static, administration of, 14-1
 - granting access rights to, 29-5
 - granting selfwrite access
 - by using ldapmodify command, 29-25
 - hierarchical, 14-6
 - membership
 - how directory server computes, 29-5

- modifying by using ldapmodify, 14-16
- names and containment, planning, 5-3
- privilege, 29-4
 - defined, 3-5
- static, 14-1
 - modifying by using ldapmodify command, 14-13
 - schema elements for creating, 14-2
 - when to use static or dynamic, 14-8
- guidelines
 - for deleting object classes, 20-4

H

- hashed attributes, 9-13
- hashed password comparisons
 - password policy attribute, 28-7
- hashing
 - passwords to the directory, 30-1
 - protection
 - MD4, 30-3
- hashing algorithms
 - default, 30-2
 - password verifiers
 - for authenticating to Oracle components, 30-4
 - userpassword, 30-2
- hashing schemes
 - for protecting user passwords, 30-2
 - retained on upgrade, 30-2
- health statistics garbage collector, 35-2
- hierarchical groups, 14-6
- hierarchies
 - explicit, 14-6
 - implicit, 14-6
- high availability, 1-6
- home page
 - ODSM
 - statistics information, 24-7
- human intervention queue, 41-3
 - managing, 41-24
 - managing processing by using ldapmodify command, 41-25
 - number of entries
 - managing by using Fusion Middleware Control, 41-13
 - processing, 41-4
 - schedule, 38-16, 40-13, 41-17
 - tools, 41-24

I

- identity management, 33-6
 - defined, 3-21
 - planning DIT for, 5-1
 - policies, 3-23
 - realms, 3-23, 33-3
 - creating additional, 33-14
 - customizing, 33-8
 - default, 3-23
 - defined, 3-23

- entry in default DIT, 33-5
- implementation in Oracle Internet Directory, 33-5
- in enterprise deployments, 33-3
- in hosted deployments, 33-4
- multiple, 33-4
- multiple in enterprise deployments, 33-4
- planning, 33-1
- single, 33-3
- single in enterprise deployments, 33-3
- realm-specific Oracle Context, 33-6
- idle connection timeout
 - tuning, 9-12
- IETF
 - LDAP approval, 1-3
- implicit hierarchies, 14-6
- inactivate replication, 40-13, 41-21
- indexed attributes, 3-6
- indexes
 - adding
 - by using ldapmodify, 20-20
 - by using ODSM, 20-15
 - created by bulkload, 15-7
 - creating by using catalog command, 15-11
 - dropping
 - by using catalog command, 15-12
 - dropping from attributes, 20-16
 - by using ldapmodify command, 20-21
 - by using ODSM, 20-15, 20-16
- inheritable ACP
 - setting up
 - by using ldapmodify command, 29-23
- inheritance, 3-12
 - and access control policies, 29-3
 - class, 3-12
 - from superclasses, 20-3
- installation errors, R-2
- instance configuration information, 10g versus 11g, A-1
- instance creation, 10g versus 11g, A-1
- instances
 - adding, 8-3
 - Oracle Internet Directory
 - adding, 8-3
 - creating the first, 8-2
 - managing, 8-1
 - registering
 - by using opmnctl command, 8-7
- instances, managing server, 8-1 to 8-10
- instance-specific configuration entry
 - attributes, 9-2
 - DN, 8-1, 9-2
 - navigating to in ODSM, 9-18
- integration, Oracle Directory Services Manager-SSO, 7-6
- intermediate template file
 - in migration from application-specific repositories, 36-7
- internationalization, and LDAP, I-1
- Internet Engineering Task Force (IETF). See IETF.

- Internet Protocol version 6
 - configuring address, 10-1
- interoperability mode
 - SSL, 26-5
- interoperability mode, SSL
 - setting by using ldapmodify command, 26-13
- introduction to directory services, 1-1 to ??
- invalid login attempts, lockout after
 - password policy attribute, 28-5
- IP addresses
 - cold failover clusters, 10-1
 - managing, 10-1
 - virtual, 10-1
- IPV4 addresses, 10-1
- IPV6 addresses, 10-1

J

- Java containers, 10g versus 11g, A-9
- Java plug-ins
 - API, E-2 to E-9
 - setting up, E-1
- jpegPhoto attribute, 3-10, 13-12

K

- keep alive
 - LDAP connection, 40-13
 - replication server connection, 38-16
- knowledge references, 3-17, 3-18, 19-1 to 19-4
 - configuring, 19-1
 - default
 - configuring, 19-4
 - defined, 3-17
 - managing, 19-1
 - overview, 3-17
 - restricting permissions for managing, 3-18
 - smart
 - configuring, 19-3
 - superior, 3-17

L

- labeleduri, 14-2
- labeledURI attribute, 14-4, 14-5, 14-6, 14-15
- language codes, as attribute options, 3-11
- last login attempt, 28-7
- last password change
 - operational attribute, 28-7
- last successful login
 - operational attribute, 28-7
- latency, operation
 - on ODSM home page, 24-7
- LDAP
 - add or modify performance, R-11
 - and internationalization, 3-15
 - and simplified directory management, 1-3
 - attributes, common, 3-10
 - communication between replication server and directory, 3-3
 - compare performance, 35-3

- extensibility, 1-3
- IETF approval, 1-3
- search performance, R-10
- security, 1-3
- server instances, 3-3
- servers, 3-3
 - multithreaded, 1-6
 - Version 3, 1-3
- LDAP filter definition, G-1 to G-6
- LDAP multimaster agreement
 - converting an Advanced Replication-based agreement to, 38-15
- LDAP operations
 - causing replication conflicts, 41-5
 - debugging, 23-7
 - tracing, 23-7
- LDAP Utilities, 7-13
- ldapadd command, 7-13
 - adding alias entries, 17-2
 - adding entries, 13-12
 - adding partial replication context, 38-33
 - attribute aliases
 - using with, 20-24
 - configuring server chaining, 37-5
 - creating attribute uniqueness constraints, 18-9
 - creating dynamic groups, 14-15
 - entries
 - adding, 13-12
 - Globalization Support, I-7
 - password policy
 - creating, 28-11
 - replication setup, 38-21
- ldapaddmt command, 7-13
 - Globalization Support, I-7
- LDAP-based partial replication
 - determining what is to be replicated, 41-2
- LDAP-based replica
 - deleting, 38-29
 - setting up, 38-18
- LDAP-based replication
 - configuring, 38-5
 - process, D-4
 - rules, 38-5
 - setup, 38-1 to 38-33
- LDAP-based replication architecture, D-4
- ldapbind command, 7-13
 - and Globalization Support, I-7
 - SSL
 - testing, 26-11
 - SSL configuration
 - testing, 26-12
- ldapcompare command, 7-13
 - Globalization Support, I-7
- LDAP-compliant directories, migrating data
 - from, 36-1
- ldapdelete command, 7-13
 - attribute aliases
 - using with, 20-25
 - deleting attribute uniqueness constraints, 18-9
 - deleting replication context, 38-32
 - Globalization Support, I-7
 - ldapmoddn command, 7-13
 - attribute aliases
 - using with, 20-25
 - Globalization Support, I-7
 - ldapmodify command, 7-13
 - adding ACPs, 29-23
 - adding attribute options, 13-13
 - adding attributes, 20-19, 20-20, 20-22
 - adding attributes to object classes, 20-19
 - adding attributes with aliases, 20-21
 - adding object classes, 20-18, 20-19
 - adding plug-in configuration entries, 43-8
 - attribute aliases
 - using with, 20-24
 - attribute aliases in existing attributes
 - modifying, 20-22
 - attribute options
 - adding, 13-13
 - deleting, 13-13
 - attributes, 20-20
 - auditing
 - enabling for replication and Oracle Directory Integration Platform, 22-6
 - managing, 22-6
 - configuring attributes of replication configuration set, 41-21
 - configuring change log purging, 35-9
 - configuring knowledge references, 19-3
 - configuring replica subentry attributes, 41-16
 - configuring replication agreement
 - attributes, 41-17
 - configuring server chaining, 37-5
 - configuring SSL, 26-10
 - configuring SSL authentication, 26-11
 - configuring SSL cipher suite, 26-11
 - configuring SSL interoperability mode, 26-11
 - configuring SSL version, 26-11
 - configuring SSL wallet URL, 26-11
 - configuring user statistics
 - configuring statistics collection, 24-10
 - content rules
 - adding, 20-25
 - debug operations
 - setting, 23-8
 - delete attribute aliases, 20-22
 - deleting attribute options, 13-13
 - disabling accounts by using, 12-2
 - enabling force flushing to log file, 23-8
 - enabling SSL, 26-11
 - entries
 - modifying, 13-13
 - selecting by DN, 29-24
 - entry level ACLs
 - setting up, 29-23
 - Globalization Support, I-7
 - granting selfwrite access to group entries, 29-25
 - indexes
 - adding, 20-20
 - dropping from attributes, 20-21

- managing anonymous binds, 32-8
- managing change log generation, 41-15
- managing human intervention queue, 41-25
- managing password verifier profiles for Oracle components, 30-10
- managing replication configuration
 - attributes, 40-14
- managing superuser, 12-6
- modifying alias entries, 17-6
- modifying attribute uniqueness constraints, 18-9
- modifying attributes, 13-13, 20-19, 20-22
- modifying dynamic groups, 14-16
- modifying garbage collectors, 35-7
- modifying replica naming context object parameters, 41-18
- modifying static groups, 14-13, 14-14
- object classes
 - adding, 20-19
- password hashing schemes
 - managing, 30-3
- password hashing schemes for creating password verifiers
 - managing, 30-3
- password policies
 - setting, 28-12
- password policy
 - applying to subtree, 28-11
- privacy mode
 - enabling, 27-7
- read-only access
 - granting, 29-25
- referential integrity
 - disabling, 21-3
 - enabling, 21-2
- replication setup, 38-22
- searching for published naming contexts, 11-2
- security event tracking
 - configuring, 24-8
- server mode
 - setting, 15-3
- setting logging levels, 23-6
- setting server mode, 15-3
- setting system configuration attributes by using, 9-16
- setting value of orclpwdverifierparams, 30-12
- SSL interoperability mode
 - setting, 26-13
- statistics collection
 - configuring, 24-8
- unlocking user accounts by using, 12-3
- user statistics
 - configuring, 24-9
- using attribute selectors
 - granting access, 29-24
- ldapmodifymt command, 7-13
 - Globalization Support, I-7
- ldapsearch
 - listing operational attributes, 13-11
- ldapsearch command
 - alias entries, 17-3
 - attribute aliases
 - using with, 20-23
 - attributes
 - listing, 13-11
 - audit configuration
 - viewing, 22-5
 - checking value of
 - orclpwdencryptionenable, 30-11
 - determining replica IDs, 38-21
 - determining replication agreement
 - replication, 38-21
 - finding orclreplicaid value
 - replication setup, 38-20
 - Globalization Support, I-7
 - identifying naming contexts
 - replication setup, 38-26
 - listing configuration attributes, 9-17
 - password policies
 - viewing, 28-11
 - printing binary values, 13-14
 - privacy mode
 - determining, 27-7
 - replication, 38-21
 - determining replication agreement, 38-21
 - replication setup
 - finding orclreplicaid value, 38-20
 - identifying naming contexts, 38-26
 - searching
 - entries with attribute options, 13-13
 - searching for published naming contexts, 11-1
 - searching password verifier profiles for Oracle components, 30-10
 - SSL attributes
 - listing, 26-11
 - statistics
 - viewing configuration, 24-8
 - syntaxes
 - viewing, 20-26
 - viewing change logs, 41-15
 - viewing matching rules, 20-26
 - viewing schema, 20-18
 - viewing syntaxes, 20-26
- LDIF file
 - using with ODSM, 13-5
- LDIF files, 7-1, 9-16, R-29
 - importing by using bulkload, 15-6
 - importing, by using bulkload, 15-6
 - removing proprietary data from in migration, 36-3
- ldifwrite command, 15-10
 - dumping entries by using, 15-10
 - getting supplier data
 - replication setup, 38-26
 - Globalization Support, I-8
 - log file location, 23-1
 - replication setup
 - getting supplier data, 38-26
 - setting up replication by using, 38-24
 - syntax, 15-11
- list of sensitive attributes, 27-6

- listener, for directory database, 3-3, 3-4
 - restarting, C-7
 - stopping, C-7
 - listener.ora, C-7
 - load balancing
 - and replication, 6-2
 - load option, in bulkload, 15-7
 - location-independence, of directories, 1-2
 - locked accounts
 - unlocking with ODSM, 12-5
 - lockout after invalid login attempts
 - password policy attribute, 28-5
 - log files, 23-1
 - 10g versus 11g, A-7
 - force flushing trace information, 23-8
 - garbage collection, 35-9
 - maximum in rotation, 41-11
 - maximum number in rotation, 23-5, 40-13
 - maximum size, 23-5, 40-13, 41-11, 41-21
 - rotation, 23-5
 - size, 41-21
 - trace messages, 23-3
 - viewing
 - by using Fusion Middleware Control, 23-5
 - log messages
 - for specific operations, 23-3
 - interpreting, 23-2
 - stored as trace objects, 23-3
 - logging, 23-1 to 23-8
 - configuring
 - by using Fusion Middleware Control, 23-5
 - features, 23-2
 - for garbage collectors, enabling and disabling, 35-8
 - format, 23-1
 - levels
 - setting by using ldapmodify command, 23-6
 - logging tab
 - server properties page
 - Fusion Middleware Control, 23-5
 - login attempts, 28-7
 - loose consistency model of replication, 6-6
 - lowercase character
 - password policy attribute, 28-6
 - LSNRCTL utility, C-7
- ## M
-
- ManageHiq.purge command, 41-3, 41-24
 - ManageHiq.retry command, 41-3, 41-24
 - managing directory schema, 20-1
 - mandatory attributes, 3-12, 20-3
 - adding to existing object classes, 20-4
 - adding to object classes in use, 20-12
 - in a user entry, 36-9
 - redefining, 20-4
 - manual resolution of conflicts, 41-24
 - match DN, 9-13
 - matching rules
 - as metadata in schema, 20-2
 - attribute, 3-11
 - cannot add to subSchemaSubentry, 20-2
 - PKI, 9-13
 - stored in schema, 20-2
 - viewing
 - by using ldapsearch command, 20-26
 - by using ODSM, 20-17
 - maximum entry cache size
 - tuning, 9-12
 - maximum log file size, 23-5
 - maximum number of worker threads, 41-2
 - maximum valid time of password
 - password policy attribute, 28-5
 - MBeans
 - defined, 2-4
 - related to Oracle Internet Directory configuration, 9-15
 - MD5
 - for password encryption, 30-3, 30-4
 - MD5 Digest, SASL authentication mechanism, 32-2
 - member attribute, 14-8, 14-11
 - messages, log
 - interpreting, 23-2
 - metadata
 - cache, 3-4
 - directory, defined, 3-4
 - stored in schema, 20-2
 - metrics
 - performance page
 - Fusion Middleware Control, 24-6
 - Microsoft Active Directory
 - with server chaining, 37-2
 - middle tier
 - using proxy user with, 32-3
 - migrating data
 - from other LDAP-compliant directories, 36-1
 - migrating third-party LDAP data
 - by using Directory Integration Platform server, 36-6
 - by using LDIF files and syncprofilebootstrap command, 36-5
 - by using syncprofile bootstrap, bulkload, and LDIF files, 36-5
 - by using syncprofilebootstrap command, 36-4
 - migration
 - from application-specific repositories
 - intermediate template file, 36-7
 - minimum password length
 - enforced by password policies, 28-4
 - password policy attribute, 28-6
 - modifiersName attribute, 3-10, 36-3, 40-8
 - optional in top, 3-13
 - modifying attribute aliases in existing attributes
 - by using ldapmodify, 20-22
 - modifying attributes by using ODSM, 20-14
 - modifying content rules
 - by using ODSM, 20-16
 - modifying dynamic groups
 - by using ODSM, 14-13
 - modifying object classes

- by using ODSM, 20-12
- modifying static groups, 14-10
 - by using ldapmodify command, 14-13
 - by using ODSM, 14-10
- modifyTimestamp attribute, 3-10, 36-3, 40-8
 - optional in top, 3-13
- monitoring Oracle Internet Directory, 24-1 to 24-11
- monitoring servers, 24-2
- multimaster flag
 - toggling, 38-22, 38-28, C-10
- multimaster replication, 6-4, 6-6
- multimaster replication groups
 - with fan-out, 38-30
 - with fan-out replication groups, 6-7
- multiple directory server instances
 - SSL
 - configuration, 26-4
- multiple server processes, 3-4
- multithreaded LDAP servers, 1-6
- multivalued attributes, 3-10
 - converting to single-valued, 20-5
 - member, 14-8, 14-11
 - orclEntryLevelACI, 29-3

N

- names
 - of groups, planning, 5-3
 - of users, planning, 5-3
- naming contexts, 3-14
 - backing up and restoring, 25-1
 - defined, 11-1
 - definition, 3-14
 - discovering, 3-14
 - in partitioned directories, 3-16
 - in replication filtering, 38-7
 - managing, 11-1
 - optimization of partial replication, 38-13
 - publishing, 3-14, 11-1
 - searching for published, 11-1
 - subordinate, 3-17
 - that cannot be excluded from replicatio, 38-12
 - that cannot be replicated, 38-12
- namingcontexts attribute, 9-11, 11-1, 11-2
 - multivalued, 11-2
- native authentication
 - contrasted with external authentication, 44-1
 - defined, 44-1
- network retry timeout
 - tuning, 9-12
- new features
 - release 11g (11.1.1), xlii
 - release 11g (11.1.1.4.0), xli
- new syntaxes, adding, 3-11
- NLS_LANG environment variable, 7-13, I-3
 - required by bulk tools, 15-1
 - setting
 - in the client environment, I-7
 - settings, I-3
- nodes, Oracle Internet Directory, 3-2

- non-alphanumeric characters
 - password policy attribute, 28-6
- non-Oracle clients
 - SSL needs, 26-5
- non-SSL port, 3-4, 9-12
- Novell eDirectory
 - with server chaining, 37-2
- null values, in attributes, 20-3
- number of entries
 - on ODSM home page, 24-7
- number of seconds between modifications
 - password policy attribute, 28-5
- number of workers
 - maximum, 40-13, 41-11
- numeric characters
 - password policy attribute, 28-6

O

- O3LOGON algorithm, 30-4
- object classes, 3-12
 - adding, 20-1
 - by using ldapmodify command, 20-18, 20-19
 - by using ODSM, 20-11
 - adding attributes
 - by using ldapmodify command, 20-19
 - as metadata in schema, 20-2
 - assigning to entries, 20-2
 - auxiliary, 3-13
 - converting auxiliary, 20-4
 - defining, 20-7
 - deleting
 - by using ODSM, 20-13
 - from base schema, 20-8
 - not in base schema, 20-4
 - extensibleObject, 19-1
 - groupOfNames, 14-8, 14-9, 14-10, 14-11
 - guidelines
 - for deleting, 20-8
 - in the base schema, modifying, 20-4
 - modifying
 - by using ldapmodify command, 20-19
 - by using ODSM, 20-12
 - orclprivilegegroup, 3-5
 - and dynamic groups, 14-3
 - redefining mandatory attributes in, 20-4
 - referral, 19-1
 - removing attributes from, 20-4
 - removing superclasses from, 20-4
 - rules, 3-13
 - searching
 - by using ODSM, 20-11
 - structural, 3-13
 - structural, converting, 20-4
 - subclasses, 3-12
 - defining, 20-7
 - superclasses, 3-12
 - top, 3-12
 - types, 3-13
 - abstract, 3-13

- auxiliary, 3-13
 - structural, 3-12
- unique name of, 20-3
- unique object identifier, 20-3
- viewing properties by using ODSM, 20-13
- object identifier as attribute alias, 20-10
- objectclasses
 - orclacpgroup, 29-4
- OCI. See Oracle Call Interface.
- ODS_PROCESS_STATUS Table, 4-2
- ODS_PROCESS_STATUS table, 4-2
- ODSM, 7-6 to 7-13
 - adding
 - entries, 13-6
 - adding ACPs, 29-16
 - from data browser, 29-21
 - adding indexes to attributes, 20-15
 - adding new attributes, 20-13
 - adding new entries, 13-6
 - adding object classes, 20-11
 - assigning password policies to subtrees, 28-10
 - attributes, searching for, 20-15
 - cataloging attributes, 20-15
 - configuring HTTP server, 7-12
 - configuring server chaining, 37-4
 - configuring session timeout, 7-12
 - configuring single sign-on integration, 7-7
 - connecting, 7-6
 - connecting as an SSO-authenticated user, 7-12
 - connecting to server, 7-9
 - copying existing entries, 13-8
 - creating attribute uniqueness constraints, 18-6
 - creating content rules, 20-16
 - creating dynamic groups, 14-10
 - creating password policies, 28-10
 - creating plug-ins, 43-9
 - creating static groups, 14-8
 - data browser icons, 13-3
 - default port, 7-2
 - deleting a subtree, 13-8
 - deleting attribute uniqueness constraints, 18-7
 - deleting attributes, 20-14
 - deleting object classes, 20-13
 - deleting plug-ins, 43-10
 - displaying directory entries, 13-2
 - dropping indexes from attributes, 20-16
 - editiing plug-ins, 43-10
 - exporting entries, 13-5
 - home page, 24-7
 - icons
 - data browser, 13-3
 - importing entries, 13-5
 - introduction, 7-6
 - invoking, 7-9
 - JAWS screen reader, 7-6
 - listing and locking a locked account, 12-4
 - logging into server, 7-10
 - managing configuration attributes, 9-18
 - managing directory schema, 20-10
 - managing password verifier profiles for Oracle
 - components, 30-10
 - managing plug-ins, 43-9
 - managing system configuration attributes, 9-18
 - modifying ACPs, 29-20
 - modifying attribute uniqueness constraints, 18-7
 - modifying attributes, 20-14
 - modifying content rules, 20-16
 - modifying dynamic groups, 14-13
 - modifying entries, 13-9
 - modifying entry-level access
 - from data browser, 29-21
 - modifying garbage collectors, 35-7
 - modifying object classes, 20-11, 20-12
 - modifying password policies, 28-9
 - navigating to from Fusion Middleware Control, 7-4
 - non-super user access, 7-6
 - registering plug-ins, 43-9
 - searching for attributes, 20-15
 - searching for entries, 13-3
 - searching for object classes, 20-11
 - selecting attribute syntax type, 20-17
 - setting entry-level access
 - from data browser, 29-21
 - single sign-on integration
 - configuring HTTP server, 7-9
 - configuring OAM, 7-8
 - supported browsers, 7-9
 - testing replication, 38-17
 - troubleshooting, R-30
 - URL, 7-9
 - using SSL, 7-11
 - viewing ACPs, 29-15
 - viewing all directory attributes, 20-15
 - viewing attributes, 13-5
 - viewing attributes for specific entries, 13-5
 - viewing local change logs, 41-8
 - viewing matching rules, 20-17
 - viewing password policies, 28-9
 - viewing properties of object classes, 20-13
 - viewing statistics information, 24-7
 - viewing syntaxes, 20-17
 - viewing version information, R-29
 - ODSSM account, 24-4
 - ODSSMadministrator account
 - password
 - changing by using WLST, 12-8
 - OID Compare and Reconcile Tool, 41-26
 - OID Control Utility
 - See oidctl command
 - OID Monitor
 - See OIEMON
 - oidcmprec command, 41-26 to 41-34
 - change log generation for changes, 41-31
 - comparing and reconciling inconsistent data, 41-26
 - conflict scenarios, 41-27
 - how it works, 41-29
 - including directory schema, 41-33
 - limitations, 41-34

- operations supported, 41-28
- output, 41-28
- overriding predefined conflict resolution rules, 41-33
- selecting attributes, 41-31
- selecting DIT, 41-30
- source and destination directories, 41-30
- user-defined operations, 41-33
- using parameter file, 41-32
- oidctl command
 - in Oracle Internet Directory node, 3-3
 - in standalone mode, B-1
 - starting replication server, 8-10, 38-22
 - troubleshooting database server, R-11
- oiddiag command
 - detecting referential integrity violations, 21-3
 - viewing statistics, 24-10
- oidexaup.sql
 - contents of, 44-3
 - for installing external authentication plug-in, 44-1
- OIDEXTAUTH PL/SQL package for external authentication, 44-2
- oidldapd dispatcher
 - in instance, 8-3
 - log file location, 23-2
 - log file name, 23-2
- oidldapd server
 - in an instance, 8-3
 - log file location, 23-2
- OIDMON, 4-1, 4-2
 - in Oracle Internet Directory node, 3-3
- OIDMON log file name, 23-2
- OIDMON process
 - in instance, 8-3
- oidpasswd command
 - changing database password, 12-6
 - resetting superuser password, 12-7
- oidrepld command
 - log file name, 23-1
- OIDUpgradePasswordPolicies command
 - replication setup, 38-29
- one-level search, 13-4
- one-way hashed values
 - userpassword verifiers, 30-2
- online directories, 1-1
- OpenLDAP Community, 0-xxxix
- operation debug, 23-7
- operation latency
 - on ODSM home page, 24-7
- operational attributes, 9-1
 - described, 9-2
 - listing with ldapsearch, 13-11
- operations enabled for debug, 23-5
- operations, limiting debugging to specific, 23-7
- OPMN
 - See Oracle Process Manager and Notification Server
- opmnctl command, 4-1
 - creating a component, 8-3
 - creating a system component, 8-6
 - registering an instance, 8-7
 - replication setup
 - starting replication server, 38-25
 - restarting server, 8-10
 - starting replication server
 - replication setup, 38-25
 - starting server, 8-9
 - stopping server, 8-10
 - viewing server instances, 8-9
 - viewing status, 8-9
- opmn.xml
 - changing database information, 8-10
 - snippet, 4-3
- optional attributes, 3-12, 20-3
 - adding to pre-defined object classes, 20-7
- options, attribute, 3-11
- ORA-1562 error, R-3
- ORA-3113 error, R-2
- ORA-3114 error, R-2
- Oracle Advanced Security, use of Oracle Internet Directory, 1-7
- Oracle Application Server Administrators Group, 31-9
- Oracle Call Interface
- Oracle components
 - privileges for administering, 31-3
- Oracle components, use of Oracle Internet Directory, 1-6
- Oracle Context
 - root, 33-5
- Oracle Context Administrators Group, 31-13
- Oracle data servers
 - changing password to, 12-6
 - error messages, R-2, R-3
- Oracle Database Advanced Replication, C-8
 - configuring, C-6, C-8
 - by using Replication Management Tool, C-6
 - for directory replication, C-8
 - features, D-1
 - installing, C-6
 - See also Advanced Replication
 - setting up, C-6
- Oracle Database Advanced Replication-based replication, 6-4, C-1 to C-15
 - See also Advanced Replication
- Oracle Database Server, 3-3
- Oracle Database Transparent Data Encryption (TDE), 27-1
- Oracle Database Vault, 27-3
- Oracle Delegated Administration Services, 10g versus 11g, A-8
- Oracle Diagnostic Logging (ODL) format, 23-1
- Oracle Directory Integration Platform
 - defined, 3-20
 - description, 1-8
 - enabling auditing, 22-6
- Oracle Directory Integration Platform auditing, 22-3
- Oracle Directory Integration Platform, 10g versus 11g, A-8
- Oracle directory replication server

- authentication, 38-6
 - component of Oracle Internet Directory, 1-5
 - component of Oracle Internet Directory node, 3-3
 - starting in Advanced Replication, C-10
- Oracle Directory Server Enterprise Edition, 37-2
- Oracle directory server instances, 1-5, 3-3
 - starting in Advanced Replication, C-10
- Oracle Directory Services Manager
 - See ODSM
 - SSO integration, 7-6
- Oracle Fusion Middleware, 2-1 to 2-5
- Oracle Globalization Support, 3-15
- Oracle home, 2-3
- Oracle Identity and Access Management
 - delegation in, 31-1
- Oracle Identity Management, 3-21
 - components, 3-21
 - group information, 5-4
 - management policies, 3-23
 - objects, 33-5
 - planning, 5-2
 - products, 3-21
 - realms, planning, 33-1
 - user information, 5-3, 33-7
 - what it does, 3-21
- Oracle instance, 2-3
 - directories under, 8-2
- Oracle Internet Director Server Manageability
 - architecture, 24-1
 - components, 24-1
- Oracle Internet Directory
 - advantages of, 1-5
 - architecture, 1-4, 3-1
 - components, 1-5
 - how Oracle components use it, 1-6
 - nodes, 3-2
 - super user password, resetting, 12-7
 - used by Oracle Advanced Security, 1-7
- Oracle Internet Directory database password
 - changing
 - by using oidpasswd, 12-6
- Oracle Internet Directory Deployment Options, 2-2
- Oracle Internet Directory ports, 3-4
- Oracle Internet Directory Self-Service Console
 - in indirect authentication of end users, 32-3
 - Self-Service Console, 3-19
- Oracle Internet Directory Server Manageability
 - architecture and components, 24-2
 - capabilities, 24-1
 - configuring, 24-4
 - framework, 24-1
 - configuring critical events, 24-9
- Oracle Net Services, 3-3, 3-7
 - preparing for Advanced Replication, C-6
 - use of Oracle Internet Directory, 1-7
- Oracle Platform Security Services
 - use of Oracle Internet Directory, 1-7
- Oracle Process Manager and Notification Server (OPMN), 3-3, 4-1
- Oracle Single Sign-On, 10g versus 11g, A-8
- Oracle Virtual Directory
 - description, 1-8
- Oracle Webcenter Suite
 - use of Oracle Internet Directory, 1-7
- ORACLE_HOME environment variable, 7-13
 - required by bulk tools, 15-1
- ORACLE_INSTANCE environment variable, 2-3, 7-13, A-6
 - required by bulk tools, 15-1
- ORACLE_SID environment variable, A-6
- orclACI, 29-3
 - access to, 29-3
- orclaci attribute, 9-11, 29-3
 - optional in top, 3-13
- orclacpgroup object class, 14-3, 29-4
- orclactivatereplication attribute, 40-9, 40-13, 41-12, 41-21
- orclactiveenddate user entry attribute, 12-3
- orclactivestartdate user entry attribute, 12-3
- orclagreementid attribute, 40-3
- orclagreementid entry, 40-6
- orclagreementtype attribute, 40-4
- orclanonymousbindsflag
 - values, 32-8
- orclanonymousbindsflag attribute, 9-5, 32-8
 - new location in 11g, A-4
- orclaudcustevents attribute, 9-4, 22-3, 22-4
- orclaudfilterpreset attribute, 9-4, 22-2, 22-4
- orclaudsplusers attribute, 9-4, 22-3, 22-4
- orclchangeretrycount attribute, 40-8, 40-13, 41-11, 41-21
- orclcommonusername attribute
 - uniqueness constraints, 18-8
- orclcommonusersearchbase attribute in realm-specific Oracle context, 30-4
- orclconfresolution attribute, 40-9, 40-13, 41-11, 41-21
- orclConnectByAttribute group attribute, 14-4
- orclConnectByStartingValue group attribute, 14-4
- orclcryptoscheme attribute, 9-11
- orcldataprivacymode attribute, 9-9, 27-6
 - new location in 11g, A-4
- orcldebugflag, 23-7
- orcldebugflag attribute, 9-4, 23-5, 23-6, 23-7
 - new location in 11g, A-4
- orcldebugforceflush attribute, 9-4, 23-8
 - new location in 11g, A-4
- orcldebuglevel attribute, 40-9, 40-13, 41-11, 41-21
 - debug levels, 41-22
- orcldebugop attribute, 9-4, 23-5
 - new location in 11g, A-4
- orcldirreplgroupsas attribute, 40-3
- orcldispthreads attribute, 9-6, 9-12
- orclDynamicGroup, 14-2
- orclDynamicList object class, 14-3
- orclcacheenabled attribute, 9-6, 9-12
 - new location in 11g, A-4
- orclcachemaxentries attribute, 9-6, 9-12
 - new location in 11g, A-4
- orclcachemaxentsize attribute, 9-6, 9-12
 - new location in 11g, A-4

orclecachemaxsize attribute, 9-6, 9-12
 new location in 11g, A-4
 orclenablegroupcache attribute, 9-6
 new location in 11g, A-4
 orclencryptedattributes attribute, 9-10, 27-6
 orclEntryLevelACI attribute, 29-3
 optional in top, 3-13
 orclpwdpolicynable attribute of password
 policies, 28-2
 orcleventlevel attribute, 9-4, 24-9
 new location in 11g, A-4
 orclxcludedattributes attribute, 40-7
 orclxcludednamingcontexts attribute, 38-31, 40-4,
 40-7
 orclxtconfflag attribute, 22-3
 orclgeneratechangelog attribute, 9-10, 9-12, 41-15
 orclGuid
 optional attribute in top, 3-13
 orclhashedattributes attribute, 9-13
 orclhqschedule attribute, 40-4, 40-13, 41-17
 orclhostname attribute, 9-3
 configuring, 10-1
 orclincludednamingcontexts attribute, 40-7
 orclinmemfiltprocess attribute, 9-10, 9-13
 orclisenabled attribute, 12-2
 orcllastappliedchangenumber attribute, 40-4
 orcllastlogintime operational attribute, 28-7
 orclldapconnkeepalive attribute, 40-4, 40-13, 41-17
 orclldapconnntimeout attribute, 9-7, 9-12
 new location in 11g, A-4
 ORCLLM algorithm, 30-4
 orclmatchdnenabled attribute, 9-10, 9-13
 new location in 11g, A-4
 orclmaxcc attribute, 9-7, 9-12
 new location in 11g, A-4
 orclmaxconnincache attribute, 9-7, 9-12
 new location in 11g, A-4
 orclmaxfilsize attribute, 9-9, 9-13
 orclmaxldapconns attribute, 9-7, 9-12
 orclmaxlogfiles attribute, 9-4, 23-5, 40-9, 40-13, 41-11,
 41-21
 orclmaxlogfilesize attribute, 9-4, 23-5, 40-9, 40-13,
 41-11, 41-21
 orclmaxserverresptime attribute, 9-7, 9-12
 orclMemberOf attribute, 14-7
 orclnonsslport attribute, 9-3
 ORCLNT algorithm, 30-4
 orclnwrtimeout attribute, 9-7, 9-12
 new location in 11g, A-4
 orclOidComponentName attribute, 40-9
 orclOidInstanceName attribute, 40-9
 orcloptcontainsquery attribute
 new location in 11g, A-4
 orcloptracklevel attribute, 9-4, 24-8
 new location in 11g, A-4
 orcloptrackmaxtotalsize attribute, 9-8, 24-9
 new location in 11g, A-4
 orcloptracknumelemcontainers attribute, 9-8, 24-9
 orclpilotmode attribute, 40-2
 in pilot mode, 41-17
 orclpkimatchingrule attribute, 9-10, 9-13, 32-2
 new location in 11g, A-4
 orclpluginworkers attribute, 9-8, 9-12
 orclprivilegeobject class, 3-5, 14-3, 29-4
 and dynamic groups, 14-3
 orclpwdaccountunlock user attribute, 12-3
 orclpwdAllowHashCompare password policy
 attribute, 28-7
 orclpwdAlphaNumeric password policy
 attribute, 28-6
 orclpwdencryptionenable
 checking value
 by using ldapsearch command, 30-11
 orclpwdEncryptionEnable password policy
 attribute, 28-7
 orclpwdencryptionenable realm attribute
 when provisioning users, 30-11
 orclpwdGraceLoginTimeLimit password policy
 attribute, 28-6
 orclpwdIllegalValues password policy
 attribute, 28-6
 orclpwdipaccountlockedtime operational
 attribute, 28-7
 orclpwdipfailuretime operational attribute, 28-7
 orclpwdIPLockout password policy attribute, 28-5
 orclpwdIPLockoutDuration password policy
 attribute, 28-6
 orclpwdIPMaxFailure password policy
 attribute, 28-6
 orclPwdMaxInactivity, 28-7
 orclpwdMaxRptChars password policy
 attribute, 28-6
 orclpwdMinAlphaChars password policy
 attribute, 28-6
 orclpwdMinLowercase password policy
 attribute, 28-6
 orclpwdMinSpecialChars password policy
 attribute, 28-6
 orclpwdMinUppercase password policy
 attribute, 28-6
 orclpwdPolicyEnable password policy
 attribute, 28-7
 orclPwdTrackLogin
 password policy attribute, 28-7
 orclpwdverifierparams
 default DN, 30-11
 orclrefreshdgrmems attribute, 9-9, 14-3
 new location in 11g, A-4
 orclReplAgreementEntry objectclass, 40-3
 orclreplautotune attribute, 40-8, 41-2, 41-11, 41-21
 orclreplicadn attribute, 40-3
 orclreplicaid attribute, 40-2, 40-13, 41-13, 41-16
 orclreplicasecondaryuri attribute, 40-2, 40-13, 41-13,
 41-16
 orclreplicastate attribute, 38-3, 40-2, 40-13, 41-13,
 41-16
 monitoring value, 38-23
 orclreplicationid attribute, 40-4
 orclreplicationprotocol attribute, 40-3
 orclreplicationstate attribute, 40-9, 40-13, 41-12,

41-21

orclreplicatype attribute, 40-2, 40-13, 41-13, 41-16
in pilot mode, 41-17

orclreplicauri attribute, 40-2, 40-13, 41-13, 41-16

orclreplmaxworkers attribute, 40-9, 40-13, 41-2,
41-11, 41-21

orclreplusesasl, 41-11

orclreplusesasl;digest-md5 attribute, 40-9, 40-13,
41-21

orclreqattrcase attribute, 9-3, 9-12

orclrevpwd attribute, 30-2, 30-11

orclRlattr attribute, 21-1

orclrienable attribute, 9-9, 9-13, 21-1

orclsaslauthenticationmode attribute, 9-5, 32-6, 32-7
new location in 11g, A-5

orclsaslcipherchoice attribute, 9-5, 32-6, 32-7
new location in 11g, A-5

orclsaslmechanism attribute, 9-6, 32-6, 32-7
new location in 11g, A-5

orclsdumpflag attribute, 9-9, 40-9, 40-13, 41-11, 41-21
new location in 11g, A-5

orclservermode attribute, 9-4
new location in 11g, A-5
setting by using ldapmodify command, 15-3

orclserverprocs attribute, 9-3, 9-12
new location in 11g, A-5

orclsizelimit attribute, 9-9, 40-9, 40-13, 41-4, 41-11,
41-21
managing by using ldapmodify, 41-25
new location in 11g, A-5

orclskewedattribute attribute, 9-10, 9-13
new location in 11g, A-5

orclskiprefinsql attribute, 9-10, 9-13
new location in 11g, A-5

orclsslauthentication attribute, 9-5, 26-3, 26-8, 26-11
new location in 11g, A-5

orclsslcpiphersuite attribute, 9-5, 26-2, 26-8, 26-11

orclsslenable attribute, 9-5, 26-4, 26-8, 26-11
new location in 11g, A-5

orclsslinteropmode attribute, 9-5, 26-5, 26-10, 26-11

orclsslport attribute, 9-3

orclsslversion attribute, 9-5, 26-8, 26-11
new location in 11g, A-5

orclsslwalleturl attribute, 9-5, 26-4, 26-8, 26-11
new location in 11g, A-5

orclstatsdn attribute, 9-9, 9-13
new location in 11g, A-5

orclstatsflag attribute, 9-4, 24-8, 24-9
new location in 11g, A-5

orclstatslevel attribute, 9-4, 24-9
new location in 11g, A-5

orclstatsperiodicity attribute, 9-5, 24-8
new location in 11g, A-5

orclsunname attribute, 12-6

orclsupassword attribute, 12-6

orclthreadspersupplier attribute, 40-8, 40-13, 41-2,
41-11, 41-21

orclthreadspersupplier;apply attribute, 41-2

orcltimelimit attribute, 9-9
new location in 11g, A-5

orcllimitmode attribute, 9-10
new location in 11g, A-5

orcluniqueattrname attribute in attribute uniqueness
constraint entries, 18-2

orcluniqueenable attribute in attribute uniqueness
constraint entries, 18-2, 18-9

orcluniqueobjectclass attribute in attribute uniqueness
constraint entries, 18-2

orcluniquescope attribute in attribute uniqueness
constraint entries, 18-2

orcluniquesubtree attribute in attribute uniqueness
constraint entries, 18-2

orclupdateschedule attribute, 40-4, 40-13, 41-17

orclUserV2 attribute, 36-9

ORCLWEBDAV algorithm, 30-4

organization attribute, 3-10

organizationalUnitName, 3-10

ou attribute, 3-10

P

parameters
for an active instance, modifying, 26-7

partial replication, 6-3
filtering, 38-7

partitioning, 3-16

password
EMD administrator
changing by using WLST, 12-7

ODSSM administrator
changing by using WLST, 12-8

replication administrator
changing by using remtool command, 41-26

superuser
changing by using Fusion Middleware
control, 12-5

password encryption
password policy attribute, 28-7

password expiration
enforced by password policies, 28-4

operational attribute, 28-7

password expiry warning
enforced by password policies, 28-4

password length
enforced by password policies, 28-4

password policies, 28-1 to 28-12
about, 28-1
applicable operations on userpassword
attribute, 28-5
applied to subtrees, 28-2
applied to superuser, 28-4
applying to subtree
by using ldapmodify command, 28-11

assigning to subtree
by using ODSM, 28-10

attributes, 28-5
creating
by using ldapadd command, 28-11
by using ODSM, 28-10
creating by using ODSM, 28-10

- default, 28-4
- defined, 28-1
- definition, 28-1
- disabling, 28-4
- DN, 28-2
- enabling, 28-2
- enforced by Oracle Internet Directory, 28-1
- entry
 - defined, 3-6
- error messages, R-9
- fine-grained, 28-2
- granularity, 28-2
- management, 3-15
- managing by using command-line tools, 28-10
- modifying
 - by using ODSM, 28-9
- modifying by using ODSM, 28-9
- plug-in, 42-1
 - how it works, 42-1
- rules, 28-1
- runtime resolution by directory server, 28-3
- setting
 - by using command-line tools, 28-10, 28-12
 - by using ldapmodify command, 28-12
- steps to establish, 28-2
- troubleshooting, R-9
- verification by directory server, 28-7
- verification of, 28-7
- viewing
 - by using ldapsearch command, 28-11
 - by using ODSM, 28-9
- password policy entries
 - location, 28-3
 - master node version, 38-28
 - replication, 38-28
- password reset
 - password policy attribute, 28-6
- password syntax check
 - password policy attribute, 28-6
- password verifier entry, defined, 3-6
- password verifier profile entries
 - for application, 30-4
 - location, 30-4
- password verifier profiles
 - for Oracle components
 - managing by using ldapmodify command, 30-10
 - searching by using ldapsearch command, 30-10
- password verifier profiles for Oracle components
 - managing
 - by using ODSM, 30-9
- password verifiers, 30-1 to 30-11
 - authenticating to Oracle components
 - managing, 30-3
 - default for Oracle components, 30-7
 - dynamic
 - generating, 30-11
 - for authenticating to the directory, 30-1
- password wallets
 - troubleshooting, R-25
- password-based authentication, 32-1
- passwords
 - command-line prompt, 7-14
 - database, 12-6
 - for guest users, 12-2
 - for proxy users, 12-2
 - for super users, 12-2
 - for superuser, 12-2
 - forcing changes by using command-line tools, 12-3
 - integrity
 - MD4, 30-3
 - managing, 12-1
 - policies
 - setting by using command-line tools, 28-10
 - protection, 3-15
 - changing by using ldapmodify command, 30-3
 - changing scheme, 30-1
 - default verifiers for Oracle components, 30-7
 - managing by using ldapmodify command, 30-3
 - MD5, 30-3, 30-4
 - O3LOGON, 30-4
 - ORCLLM, 30-4
 - ORCLNT, 30-4
 - ORCLWEBDAV, 30-4
 - SASL/MD5, 30-4
 - SHA-1, 30-3, 30-4
 - SMD5, 30-3
 - SSHA, 30-3
 - UNIX Crypt, 30-3, 30-4
 - to Oracle components
 - storing, 30-5
 - to Oracle data servers, changing, 12-6
- passwords and accounts, managing, 12-1 to ??
- PATH environment variable, 7-13
 - required by bulk tools, 15-1
- path names, 10g versus 11g, A-7
- peer-to-peer replication, 6-4
- performance
 - add or modify, R-11
 - by using orclEntryLevelACI, 29-3
 - replication and, 6-2
 - search, R-10
 - troubleshooting, R-10
- performance page metrics
 - Fusion Middleware Control, 24-6
- performance monitoring garbage collector, 35-3
- permissions, 3-15, 29-1
 - granting
 - by using ODSM, 29-15
- pilot mode, 41-4
 - specifying by using remtool command, 41-17
- pilotstarttime attribute, 40-2
 - in pilot mode, 41-17
- PKE matching rules, 9-13
- PKI authentication, 26-2
- PL/SQL plug-in developer's reference, F-1 to F-23

- plug-in configuration entries
 - adding by using ldapmodify command, 43-8
- plug-in framework, 43-3
- plug-in threads
 - per server process
 - tuning, 9-12
- plug-ins
 - benefits, 43-3
 - configuration entries, 43-6
 - creating, 43-5
 - creating by using ODSM, 43-9
 - deleting by using ODSM, 43-10
 - editing by using ODSM, 43-10
 - entry, 3-6
 - external authentication, 44-1
 - for password policies, 42-1
 - garbage collection, 35-1
 - guidelines, 43-3
 - in replication environment, 43-5
 - languages supported, 43-2
 - managing by using ODSM, 43-9
 - password policy
 - how it works, 42-1
 - registering by using ODSM, 43-9
 - registering from command line, 43-6
 - supported operations, 43-4
- point-to-point replication, 6-5
- policies
 - identity management, 3-23
- pooling, connection, 1-6
- port configuration
 - troubleshooting, R-12
- ports
 - assignment, 3-4
 - default
 - Oracle Internet Directory, 3-4
 - default, 10g versus 11g, A-5
 - non-SSL, 9-12
 - privileged, 7-3
 - SSL, 9-12
- postinstallation tasks, 7-2, 7-2 to 7-3
- precedence
 - at the attribute level, 29-13
 - at the entry level, 29-13
 - rules
 - ACL evaluation, 29-12
 - in conflicting access policies, 29-3
- prescriptive access control, 29-3
- Preserving case of required attribute name in search request, 9-12
- previously used passwords
 - operational attribute, 28-7
- privacy mode, 27-6
 - determining
 - by using ldapsearch, 27-7
 - enabling
 - by using ldapmodify command, 27-7
- privacy, data, 3-15, 27-7
- privilege groups, 29-4
 - associated with orclprivilegegroup object class, 29-4
 - defined, 3-5
- privileged accounts, 12-2
- privileged ports, 7-3
- privileged user
 - access to data
 - prevented with Database Vault, 27-3
 - types, 28-5
- privileges, 3-15, 29-1
- privileges for user and group management
 - delegation of, 31-3
- process control, 4-1 to 4-5
 - architecture, 4-1
 - best practices, 4-5
- process management, 10g versus 11g, A-1
- process monitoring, 4-5
- processes
 - on ODSM home page, 24-7
- properties
 - server
 - managing by using Fusion Middleware Control, 9-11
 - shared
 - managing by using Fusion Middleware Control, 9-13
- proxy users, 32-3
 - managing
 - by using ldapmodify, 12-6
 - by using ODSM, 12-5
- public key infrastructure, 26-2
- public-key encryption
 - described, 26-2
- purge queue, 41-3
- purging change logs, 35-5
- pwdaccountlockedtime operational attribute, 28-7
- pwdAllowUserChange password policy
 - attribute, 28-7
- pwdchangedtime operational attribute, 28-7
- pwdCheckSyntax password policy attribute, 28-6
- pwdexpirationwarned operational attribute, 28-7
- pwdExpireWarning password policy attribute, 28-6
- pwdFailureCountInterval password policy
 - attribute, 28-6
- pwdfailuretime operational attribute, 28-7
- pwdGraceLoginLimit password policy
 - attribute, 28-6
- pwdgraceusetime operational attribute, 28-7
- pwdhistory operational attribute, 28-7
- pwdInHistory password policy attribute, 28-6
- pwdLockout password policy attribute, 28-5
- pwdLockoutDuration password policy
 - attribute, 28-5
- pwdMaxAge password policy attribute, 28-5
- pwdMaxFailure password policy attribute, 28-6
- pwdMinAge password policy attribute, 28-5
- pwdMinLength password policy attribute, 28-6
- pwdMustChange password policy attribute, 12-3, 28-6
- pwdpolicy entry, 12-3
- pwdpolicy object class, 28-2

- creating values
 - step in establishing policies, 28-2
- pwdpolicysubentry attribute in subtree, 28-2
- pwdreset operational attribute, 28-7

Q

- queue statistics
 - viewing
 - by using Fusion Middleware Control, 41-13

R

RDNs. See relative distinguished names (RDNs)

read-only access

- granting
 - by using ldapmodify command, 29-25

realms, 33-1 to ??, 33-3, ?? to 33-14

- identity management
 - customizing, 33-8

- default, 3-23, 33-6

- defined, 3-23

- implementation in Oracle Internet Directory, 33-5

- in enterprise deployments, 33-3

- in hosted deployments, 33-4

- multiple in enterprise deployments, 33-4

- planning, 33-1

- single in enterprise, 33-3

realm-specific

- Oracle Context, 33-6

- password policy, 28-2

- privileged user, 28-5

recovery features, in Oracle, 1-6

redefining mandatory attributes, 20-4

ref attribute, 9-11, 19-1

referential integrity, 9-13, 21-1 to 21-4

- 10g versus 11g, A-8

- configuring specific attributes

- by using catalog command, 21-3

- defined, 21-1

- disabling

- by using ldapmodify command, 21-3

- disabling by using Fusion Middleware

- Control, 21-2

- enabling

- by using Fusion Middleware Control, 21-2

- by using ldapmodify command, 21-2

- violations

- detecting by using oiddiag command, 21-3

referral object class, 19-1

referrals, 3-17

- client-side referral caching, 19-1

- defined, 3-17

- kinds, 3-18

refresh dynamic group membership, 14-3

registering with WebLogic server, 8-2, 8-4

relational databases contrasted to directories, 1-2

relative distinguished names (RDNs), 3-8

remtool

- performing a rolling upgrade, Q-1

remtool command

- adding an LDAP-based replica, 38-20

- adding replica

- replication setup, 38-26

- Advanced Replication, C-8

- backing up data

- replication setup, 38-25

- changing replication administrator's

- password, 41-26

- replication setup, 38-3

- adding replica, 38-26

- backing up data, 38-25

- specifying pilot mode, 41-17

- troubleshooting, R-28

- verifying replication, 41-24

- viewing queue statistics, 41-24

repeated characters

- password policy attribute, 28-6

replica details

- configuring by using Fusion Middleware Control, 41-12

replica ID, 40-13, 41-13, 41-16

replica naming context object

- parameters, 41-18 to 41-21

replica naming context objects

- viewing and modifying

- by using Fusion Middleware Control, 41-8

replica primary URI, 40-13, 41-13, 41-16

replica secondary URI, 40-13, 41-13, 41-16

replica state, 41-13, 41-16

replica status, 40-13

replica subentry

- configuring attributes by using ldapmodify command, 41-16

- DN, 40-2, 41-16

- example, 40-2

- modifying by using Fusion Middleware Control, 41-9

replica type, 40-13, 41-13, 41-16

replicas

- defined, 6-4

replicated directories, conceptual discussion, 3-16

replication, 3-16

- activate and inactivate, 40-13, 41-21

- adding a new entry to a consumer, D-8

- Advanced Database, 3-16

- Advanced replication-based and

- LDAP-based, 6-4

- agreement entry, 40-3

- agreements, 6-4

- example of, 40-9

- and high availability, 6-9

- and load balancing, 6-9

- and local availability, 6-8

- and performance, 6-2

- and SSL, 38-7

- authentication, 38-6

- change logs in, 41-3

- command-line setup

- LDAP-based, 38-17
- command-line tools, 38-3
- comparing and reconciling inconsistent data, 41-26
- configuring
 - Oracle Database Advanced Replication, C-8
- conflicts
 - automatically resolve, 40-13, 41-11
 - levels of occurrence, 41-5
 - monitoring, 41-22
 - resolving manually, 41-24
 - typical causes of, 41-5
- converting Advanced Replication-based agreement to LDAP-based agreement, 38-15
- deleting an entry, D-9
- directory replication group (DRG), 6-4
- enabling auditing, 22-6
- failure tolerance, 6-2
- fan-out, 6-5
- filtering, 38-7
- full, 6-3
- groups
 - multimaster, 3-16
- LDAP
 - filtering, 38-8
- LDAP-based, 38-2
 - configuring, 38-5
 - deleting, 38-29
 - determining what is to be replicated, 41-2
 - installing and configuring, 38-17
 - process, D-4
 - setting up, 38-16, 38-18
- LDAP-based replication agreement
 - deleting, 41-10
- load balancing, 6-2
- loose consistency model, 6-6
- managing and monitoring, 41-1 to 41-34
- managing naming contexts and attributes, 38-12
- modifying a DN, D-11
- modifying an RDN, D-10
- multimaster, 6-4
- multimaster with fan-out, 6-7
- naming context container entry, 40-6
- naming contexts
 - included and excluded, 38-7
- partial, 6-3
- optimization, 38-13
- peer-to-peer, 6-4
- point-to-point, 6-5
- process, D-8, D-9, D-10, D-11
- reasons for using, 6-1
- security, 38-6
- See also Advanced Replication, Oracle Database
 - Advanced Replication-based Replication, LDAP-based replication
- server
 - log file location, 23-1
- setting up by using replication wizard in Fusion Middleware Control, 38-16
- single master, 3-16
 - defined, 6-4
 - SSL mode, 38-7
 - transport mechanisms, 38-2
 - troubleshooting, R-18, R-22, R-23
 - with server chaining, 37-3
- replication administrator password
 - changing by using remtool command, 41-26
- replication agreement entry
 - DN, 40-3
- replication agreements
 - attributes, 38-4
 - examples, 40-5
 - modifying by using Fusion Middleware Control, 41-9
 - on ODSM home page, 24-7
 - viewing by using Fusion Middleware Control, 41-9
- replication and SSL, 38-7
- replication architecture
 - LDAP-based, D-4
- replication attributes
 - configuring, 40-12
- replication auditing, 22-3
- replication authentication, 38-6
- replication bind DN password, 38-6
- replication binds
 - SASL, 40-13, 41-21
- replication bootstrap
 - troubleshooting, R-21
- replication concepts, 6-1
- replication configuration attributes, 40-1 to 40-14
 - command line, 40-14
- replication configuration container attributes, 40-1
- replication configuration container entry
 - example, 40-1
- replication configuration set
 - DN, 40-8
- replication configuration set DN, 41-21
- replication conflicts
 - automatically resolve, 41-21
 - types, 41-5
- replication cycle
 - entries to process, 41-11
 - maximum number of entries to process, 41-21
 - number of entries to process, 40-13
- Replication Environment Management Tool
 - See remtool
- replication failover, 39-1 to 39-10
 - described, 39-1
 - limitations and warnings, 39-4
 - stateless, 39-5
 - time-based, 39-8
 - types, 39-5
- replication filtering, 38-7
 - examples, 38-8
 - rules, 38-8
- replication filtering examples, 38-8 to 38-12
- replication frequency, 40-13, 41-17
- Replication Management Tool, C-6
- replication naming context container entry, 40-6

- replication naming context object entry, 40-6
 - DN, 40-6
 - example, 40-7
 - replication objects
 - examples, 40-9
 - replication server
 - credentials, 38-6
 - in Oracle Internet Directory node, 3-3
 - starting
 - by using oidctl command, 8-10
 - with SSL-enabled directory server, 26-4
 - replication server connection, 41-17
 - keep alive, 38-16
 - replication server debug level, 41-11, 41-21
 - replication setup
 - customized settings, 38-18
 - human intervention queue schedule, 38-16
 - modifying by using Fusion Middleware Control, 41-9
 - restoring entries from other components, 38-23
 - tasks performed by remtool command, 38-3
 - viewing by using Fusion Middleware Control, 41-9
 - replication status, 40-13, 41-12, 41-21
 - replication type
 - choosing
 - by using Fusion Middleware Control, 38-16
 - replication wizard
 - See Fusion Middleware Control replication wizard
 - replication, 10g versus 11g, A-8
 - replication, basics, 6-1 to 6-9
 - Repository Creation Assistant (repca)
 - troubleshooting, R-20
 - resetting your password
 - by using self-service console, 12-4
 - resource access information, 3-24
 - resource information, 3-24
 - location in DIT, 3-24
 - resource type information, 3-24
 - restarting server
 - by using Fusion Middleware Control, 8-5
 - by using opmnctl command, 8-10
 - restricting ACIs users can add, 29-22
 - retry queue, 41-3
 - retry timeout
 - tuning, 9-12
 - rolling upgrade, Q-1
 - Root DSE entry
 - defined, 3-5
 - root Oracle Context, 33-5
 - rotation
 - log files, 23-5
- S**
-
- SASL
 - clients enabled with
 - Digest-MD5 authentication to directory server, 32-5
 - external authentication, 32-5
 - SASL for replication binds, 40-13, 41-11, 41-21
 - SASL/MD5, for generating password verifier, 30-4
 - scalability, of Oracle Internet Directory, 1-6
 - schema, 20-1 to 20-26
 - administration, 20-1
 - definitions in subSchemaSubentry, 20-2
 - directory, defined, 3-5
 - for orclACI, H-1
 - for orclEntryLevelACI, H-2
 - search
 - and compare operations, 3-11
 - configuring, 8-5
 - depth, specifying, 13-4
 - filters
 - maximum size, 9-13
 - processing in memory, 9-13
 - for attributes by using ODSM, 20-15
 - for object classes
 - by using ODSM, 20-11
 - maximum entries returned, 9-12
 - maximum time to complete, 9-12
 - processing, 3-6
 - results, specifying maximum number of entries
 - returned, 13-4
 - skip referral for, 9-13
 - specifying maximum number of entries
 - returned, 13-4
 - search request
 - preserving case of attribute name, 9-12
 - secure
 - port 3133, 26-3
 - secure mode
 - running server instances in, 26-3
 - Secure Sockets Layer
 - See SSL
 - security, 1-6
 - credentials, stored in an external repository, 44-1
 - for different clients, 26-4
 - in LDAP Version 3, 1-3
 - in replication, 38-6
 - SSL parameters for different clients, 26-4
 - Security Administrators Group, 31-12
 - security and refresh events garbage collector, 35-2
 - security event tracking
 - configuring
 - by using ldapmodify command, 24-8
 - security in Oracle Internet Directory, 3-14
 - self-service console
 - of Delegated Administration Services, 12-4
 - resetting your password, 12-4
 - unlocking accounts by using, 12-4
 - self-signed wallet for SSL configuration
 - creating
 - by using Fusion Middleware Control, 26-6
 - selfwrite access
 - to groups
 - granting by using ldapmodify command, 29-25
 - sensitive attributes
 - list, 27-6

- stored in encrypted format, 27-6
- server
 - instances
 - running in secure mode, 26-3
 - restarting
 - by using Fusion Middleware Control, 8-5
 - by using `opmnctl` command, 8-10
 - starting
 - by using Fusion Middleware Control, 8-5
 - by using `opmnctl` command, 8-9
 - stopping
 - by using Fusion Middleware Control, 8-5
 - by using `opmnctl` command, 8-10
- server chaining, 37-1 to 37-16
 - 10g versus 11g, A-8
 - attribute mapping, 37-8
 - configuration entry attributes, 37-6
 - configuring
 - by using `ldapadd` and `ldapmodify` commands, 37-5
 - by using ODSM, 37-4
 - debugging, 37-14
 - described, 37-1
 - entries
 - DNs, 37-3
 - examples, 37-9 to 37-14
 - Microsoft Active Directory plug-in for password change notification, 37-14
 - plug-in for password change notification
 - Enterprise User Security, 37-14
 - supported directory servers, 37-2
 - supported operations, 37-3
 - troubleshooting, R-29
 - user and group containers, 37-8
 - with replication, 37-3
 - with SSL, 37-1
- server instances
 - in standalone mode, B-1
- server manageability
 - See Oracle Internet Director Server Manageability
- server mode, 9-12
- server plug-ins, 43-1 to 43-10
 - defined, 43-1
 - languages supported, 43-2
 - See also plug-ins
- server processes, 4-1
 - number
 - tuning, 9-12
- server properties
 - managing
 - by using Fusion Middleware Control, 9-11
- server properties page
 - Fusion Middleware Control, 9-11
 - logging tab
 - Fusion Middleware Control, 23-5
- server response time
 - maximum
 - tuning, 9-12
- server response to dispatcher
 - tuning, 9-12
- server startup
 - troubleshooting, R-12
- server statistics
 - monitored by server manageability framework, 24-1
- servers
 - monitoring, 24-2
- servers. See also directory servers, directory replication servers, or directory integration platform servers
- Service Registry, 3-19
- Service to Service Authentication, 3-19
- Setting, 29-15, C-4
- SHA-1
 - for password encryption, 30-3, 30-4
- SHA-2 algorithm, 30-2
- SHA256, 30-3, 30-4
- SHA384, 30-3, 30-4
- SHA512, 30-3, 30-4
- shared properties
 - managing
 - by using Fusion Middleware Control, 9-13
- simple authentication, 32-1
- Simple Authentication and Security Layer (SASL) authentication, 32-1
 - clients enabled with
 - Digest-MD5 authentication to directory, 32-5
 - external authentication, 32-5
 - how it works, 32-5
 - in LDAP Version 3, 1-3
- Single Sign-On
 - understanding integration with Oracle Directory Services Manager, 7-6
- single-master replication
 - defined, 6-4
- single-valued attributes, 3-10
 - converting to multivalued, 20-5
- skewed attributes, 9-13
- skip referral for search, 9-13
- smart knowledge references (referrals)
 - configuring, 19-3
- SMD5, 30-4
 - for password encryption, 30-3
- sn entry attribute
 - adding, 13-12
- special purpose directories, 1-2
- sponsor node
 - Advanced Replication, C-12
- sqlnet.ora, configuring for Advanced Replication, C-6
- SSHA, 30-4
 - for password encryption, 30-3
- SSHA256, 30-3, 30-4
- SSHA384, 30-3, 30-4
- SSHA512, 30-3, 30-4
- SSL, 26-1 to ??, 26-10, ?? to 26-13
 - and replication, 38-7
 - attributes
 - listing by using `ldapsearch` command, 26-11
 - authentication

- configuring by using ldapmodify command, 26-11
- authentication modes, 26-3
 - setting by using Fusion Middleware Control, 26-8
 - testing, 26-12
- cipher suites, 26-2
 - configuring by using ldapmodify command, 26-11
 - supported in Oracle Internet Directory, 26-2
- client scenarios, 26-3
- configuration
 - testing by using ldapbind command, 26-12
- configuration parameters, 26-3
- configuration service, 26-4
- configuring, 26-7
 - by using ldapmodify command, 26-10
 - by using WLST, 26-8
- connection failures
 - interoperability mode, 26-5
- described, 26-1
- enabling
 - by using Fusion Middleware Control, 26-8
 - by using ldapmodify command, 26-11
- handshake, 26-2
- interoperability mode, 26-5
 - configuring by using ldapmodify command, 26-11
 - setting by using ldapmodify command, 26-13
- managing, 26-1
- mode
 - replication, 38-7
- on a non-SSL port, 26-5
- parameters, 26-3, 26-8
 - configuring by using command-line tools, 26-10
 - configuring by using Fusion Middleware Control, 26-7
 - configuring by using Oracle Enterprise Manager, 26-7
 - different directory server instances, 26-4
- replication and, 38-7
- replication issues, 26-4
- server cipher suite
 - setting by using Fusion Middleware control, 26-8
- strong authentication, 26-2
- testing
 - by using ldapbind command, 26-11
 - by using ODSM, 26-11
- version
 - configuring by using ldapmodify command, 26-11
 - setting by using Fusion Middleware Control, 26-8
- with server chaining, 37-1

SSL port, 3-4, 9-12

SSL wallet URL

- setting
 - by using Fusion Middleware Control, 26-8
 - by using ldapmodify command, 26-11
- stack dumps
 - generate, 41-11, 41-21
 - generating, 40-13
- standalone mode, B-1 to B-4
- starting and stopping the Oracle stack, P-1 to P-3
- starting Oracle Internet Directory
 - concepts, 4-4
- starting replication server
 - by using oidctl command, 8-10
- starting server
 - by using Fusion Middleware Control, 8-5
 - by using opmnctl command, 8-9
- starting the Oracle stack, P-1
- startTLS, 26-5
- static groups, 14-1
 - creating
 - by using ODSM, 14-8
 - modifying
 - by using ODSM, 14-10
 - modifying by using ldapmodify command, 14-14
 - schema elements for creating, 14-2
- statistics collection
 - configuring
 - by using Fusion Middleware Control, 24-5
 - by using ldapmodify command, 24-8
 - configuring by using Fusion Middleware Control, 24-4
 - configuring user
 - by using ldapmodify command, 24-10
 - users
 - configuring by using ldapmodify command, 24-9
- statistics collector
 - DN, 35-5
 - entry for, 35-5
 - managing behavior, 35-3
- statistics configuration
 - viewing
 - by using ldapsearch command, 24-8
- statistics information
 - home page
 - Fusion Middleware Control, 24-6
 - ODSM, 24-7
 - home page, ODSM, 24-7
 - viewing
 - by using Fusion Middleware Control, 24-6
- statistics reports
 - viewing
 - by using oiddiag command, 24-10
- status
 - viewing
 - by using opmnctl command, 8-9
 - viewing by using Fusion Middleware Control, 8-4
- stopping server, 4-4
 - by using Fusion Middleware Control, 8-5
 - by using opmnctl command, 8-10
- stopping the Oracle stack, P-2
- store-and-forward transport, in Oracle Database

- Advanced Replicaton, D-1
- strong authentication, 32-1
- structural object class type, 3-13
- structural object classes, 3-13
 - converting, 20-4
 - type, 3-12
- structure rules, not enforced by Oracle Internet Directory, 3-13
- subclasses, 3-12
- subentries, definition, 20-2
- subentry attribute, 9-11
- subject selectors, 29-24
- subordinate naming contexts, 3-17
- subSchemaSubentry
 - holding schema definitions, 20-2
- subtree level search, 13-4
- Sun Java System Directory Server
 - with server chaining, 37-2
- super user password, resetting, 12-7
- super users
 - managing
 - by using ldapmodify command, 12-6
- superclasses, 3-12
 - and inheritance, 20-3
- superior knowledge references (referrals), 3-17
- superuser
 - account lockout, 28-4
 - definition, 12-2
 - managing by using ldapmodify, 12-6
 - password
 - changing by using Fusion Middleware Control, 12-5
 - resetting by using oidpasswd, 12-7
 - subject to password policies, 28-4
- suppliers
 - defined, 6-4
- syncprofilebootstrap command
 - migrating third-party LDAP data, 36-4
- syntax
 - attribute, 3-11
 - stored in schema, 20-2
- syntaxes
 - cannot add to subSchemaSubentry, 20-2
 - new, adding, 3-11
 - viewing
 - by using by using ldapsearch command, 20-26
 - by using ldapsearch command, 20-26
 - by using ODSM, 20-17
- system components
 - creating by using opmnctl command, 8-6
 - creating Oracle Internet Directory, 8-2
 - defined, 2-2
- system operational attributes
 - setting, 9-1
 - by using ldapmodify, 9-16
 - by using ODSM, 9-11
 - viewing, 9-1
- system resource events garbage collector, 35-3

T

- table space encryption
 - described, 27-1
 - enabling or disabling
 - on databases used by Oracle Internet directory, 27-1
- TCP/IP Problems, R-8
- telephoneNumber attribute, 3-10
- testing SSL configuration
 - by using ldapbind command, 26-12
 - by using ODSM, 26-11
- threads
 - in logging, 23-3
 - plug-in
 - tuning, 9-12
- threads per supplier
 - apply, 40-13, 41-11, 41-21
 - transport, 40-13, 41-11, 41-21
- time when account locked
 - operational attribute, 28-7
- time-based change log purging, 35-5
- timeout
 - connection
 - tuning, 9-12
- TLS and SSL protocols, 26-2
- TNS_ADMIN environment variable, 7-13
- tnsnames.ora
 - configuring for Advanced Replication, C-6
- tombstone garbage collector, 35-3
- top object class, 3-12, 3-13
 - optional attributes in, 3-13
- trace information
 - force flushing
 - to log file, 23-8
- trace messages
 - in log files, 23-3
- trace objects
 - log messages
 - storage as, 23-3
- tracing function calls, 23-7
- tracing LDAP operations, 23-7
- tracking of user's last login time
 - password policy attribute, 28-7
- transport threads per supplier, 40-13
- tree view
 - browsing, 13-4
 - selecting root of search, 13-4
- troubleshooting
 - replication, R-23
- troubleshooting, R-1 to R-33
 - bulk tools, R-28
 - bulkload command, R-26
 - catalog command, R-28
 - change log garbage collection, R-24
 - database server performance, R-11
 - directory server instance startup, R-12, R-14
 - dynamic password verifiers, R-25
 - Fusion Middleware Control, R-29
 - getting a core dump, R-8
 - getting a stack trace, R-8

- ODSM, R-30
- password policies, R-9
- password wallets, R-25
- performance, R-10
- port configuration, R-12
- remtool command, R-28
- replication, R-18, R-22
- replication bootstrap, R-21
- Repository Creation Assistant (repca), R-20
- server chaining, R-29
- typical problems in Oracle Internet Directory, R-1
- Trusted Application Administrators Group, 31-10
- tuning, 34-1 to ??
 - database connections, 9-12
 - dispatcher threads, 9-12
 - enable or disable change log generation, 9-12
 - enable or disable entry cache, 9-12
 - idle connection timeout, 9-12
 - maximum entries in entry cache, 9-12
 - maximum plug-in threads per server
 - process, 9-12
 - network retry timeout, 9-12
 - privilege group membership cache
 - tuning, 9-12
 - server processes, 9-12
 - server response time
 - maximum, 9-12
- types
 - of attributes, 3-9

U

- Unicode Transformation Format 8-bit (UTF-8)
- uniqueness constraints
 - orclcommonusername attribute, 18-8
- UNIX crypt
 - for password encryption, 30-3, 30-4
- unlocking accounts, 12-3
 - by using self-service console, 12-4
- unspecified access, 29-11
- uppercase characters
 - password policy attribute, 28-6
- Uptime
 - on ODSM home page, 24-7
- used passwords
 - password policy attribute, 28-6
- user
 - names and passwords, managing
 - by using ldapmodify, 12-6
- user account
 - unlocking, 12-3
- user and group containers
 - server chaining, 37-8
- user certificates
 - searching for, K-1 to K-3
- user DN, 9-13
- user entry attributes, 12-2
- User Management Application Administrators Group, 31-10
- user must reset password

- operational attribute, 28-7
- User Proxy Privilege Group, 31-13
- user statistics collection
 - configuring
 - by using ldapmodify command, 24-9, 24-10
- usercertificate attribute, K-1
- userpassword attribute
 - adding, 13-12
 - applicable operations
 - in password policies, 28-5
 - hash values, 36-4
 - of entry, 30-2
- userpassword hashing algorithm, 30-2
- userpassword parameter, 30-11
- users
 - entries
 - adding by using ldapadd, 13-12
 - modifying by using ldapmodify, 13-13
 - names and containment, planning, 5-3
 - proxy, 32-3
- users to always audit, 22-4
- UTF-8. See Unicode Transformation Format 8-bit

V

- Verifier Services Group, 31-12
- verifying replication
 - by using remtool, 41-24
- version information
 - viewing by using ODSM, R-29
- viewing all directory attributes by using ODSM, 20-15
- viewing properties of object classes by using ODSM, 20-13
- viewing queue statistics
 - by using remtool, 41-24
- viewing schema
 - by using ldapsearch command, 20-18
- viewing syntaxes
 - by using ldapsearch command, 20-26
- virtual IP addresses, 10-1

W

- wallets
 - creating by using Fusion Middleware Control, 26-6
 - creating with WLST, 26-8
 - for replication identity
 - pathname, 38-6
 - self-signed
 - creating by using Fusion Middleware Control, 26-6
 - with SSL, 26-4
- WebLogic domain
 - registration with, 8-2
- WebLogic Scripting Tool See WLST
- WebLogic Server Administrative Console
 - default port, 7-2
- WebLogic Server Domain

- defined, 2-1
- WebLogic Server Home
 - defined, 2-3
- wildcards, in setting access control policies, 29-23
- wizards
 - replication, 40-13
- WLST
 - changing EMD administrator password, 12-7
 - changing ODSSM administrator password, 12-8
 - configuring SSL, 26-8
 - defined, 2-4, 7-14
 - managing auditing, 22-5
 - managing configuration attributes by using, 9-14
- worker threads
 - managing, 41-2
 - maximim number, 40-13
 - maximum number, 41-21
 - replication, 41-2

X

- X509 certificates
 - in wallets, 26-4